

FLUKE®

902 FC

HVAC True-rms Clamp Meter

Users Manual

PN 4748982

December 2015

© 2015 Fluke Corporation. All rights reserved. Specifications are subject to change without notice. All product names are trademarks of their respective companies.

LIMITED WARRANTY AND LIMITATION OF LIABILITY

This Fluke product will be free from defects in material and workmanship for three years from the date of purchase. This warranty does not cover fuses, disposable batteries, or damage from accident, neglect, misuse, alteration, contamination, or abnormal conditions of operation or handling. Resellers are not authorized to extend any other warranty on Fluke's behalf. To obtain service during the warranty period, contact your nearest Fluke authorized service center to obtain return authorization information, then send the product to that Service Center with a description of the problem.

THIS WARRANTY IS YOUR ONLY REMEDY. NO OTHER WARRANTIES, SUCH AS FITNESS FOR A PARTICULAR PURPOSE, ARE EXPRESSED OR IMPLIED. FLUKE IS NOT LIABLE FOR ANY SPECIAL, INDIRECT, INCIDENTAL OR CONSEQUENTIAL DAMAGES OR LOSSES, ARISING FROM ANY CAUSE OR THEORY. Since some states or countries do not allow the exclusion or limitation of an implied warranty or of incidental or consequential damages, this limitation of liability may not apply to you.

Fluke Corporation
P.O. Box 9090
Everett, WA 98206-9090
U.S.A.

Fluke Europe B.V.
P.O. Box 1186
5602 BD Eindhoven
The Netherlands

11/99

Table of Contents

Title	Page
Introduction	1
How to Contact Fluke.....	2
Safety Information	3
Product Familiarization	9
Use the Product	12
Measure AC and DC Voltage	12
Measure Resistance and Continuity.....	13
Measure Microamps μ A	14
Measure Temperature.....	16
Measure Capacitance	18
Measure AC Current	18
Backlight.....	20
MIN MAX Recording Mode.....	20
Display HOLD.....	21
Auto Off	21
Maintenance	22
Clean the Product.....	22
Battery Replacement.....	23
Replacement Parts	25
Fluke Connect.....	25
Specifications	26
Electrical Specifications.....	26
General Specifications	27

Introduction

The Fluke 902 FC is a hand-held battery-operated HVAC True-rms Clamp Meter (the Product) that measures:

- AC current
- DC current (up to 200 μ A for flame rod testing through input terminals)
- AC and DC voltages
- Capacitance
- Resistance
- Continuity
- Temperature in both Celsius ($^{\circ}$ C) and Fahrenheit ($^{\circ}$ F)

The Product comes with:

- Two AA alkaline batteries (installed)
- Users Manual
- Soft carrying case
- TL75 Test Leads (one pair)
- 80BK Integrated Temperature Probe (the Probe)
- Fluke Connect

902 FC
Users Manual

How to Contact Fluke

To contact Fluke:

- Technical Support USA: 1-800-44-FLUKE (1-800-443-5853)
- Calibration/Repair USA: 1-888-99-FLUKE (1-888-993-5853)
- Canada: 1-800-36-FLUKE (1-800-363-5853)
- Europe: +31 402-675-200
- Japan: +81-03-6714-3114
- Singapore: +65-6799-5566
- Anywhere in the world: +1-425-446-5500

Or, visit Fluke's website at www.fluke.com.

To register your product, visit <http://register.fluke.com>.

To see, print, or download the latest manual supplement, visit <http://us.fluke.com/usen/support/manuals>.

Safety Information

A **Warning** identifies conditions and procedures that are dangerous to the user. A **Caution** identifies conditions and procedures that can cause damage to the Product or the equipment under test.

⚠⚠ Warning

To prevent possible electrical shock, fire, or personal injury:

- Carefully read all instructions.
- Read all safety information before you use the Product.
- Use the Product only as specified, or the protection supplied by the Product can be compromised.
- Do not use the Product around explosive gas, vapor, or in damp or wet environments.
- Do not use the Product if it is damaged
- Disable the Product if it is damaged.
- Do not use the Product if it operates incorrectly.
- Use only correct measurement category (CAT), voltage, and amperage rated probes, test leads, and adapters for the measurement.

- Do not exceed the Measurement Category (CAT) rating of the lowest rated individual component of a Product, probe, or accessory.
- Comply with local and national safety codes. Use personal protective equipment (approved rubber gloves, face protection, and flame-resistant clothes) to prevent shock and arc blast injury where hazardous live conductors are exposed.
- Before each use, examine the Product. Look for cracks or missing pieces of the clamp housing or output cable insulation. Also look for loose or weakened components. Carefully examine the insulation around the jaws.
- Do not use test leads if they are damaged. Examine the test leads for damaged insulation and measure a known voltage.
- Do not touch voltages >30 V ac rms, 42 V ac peak, or 60 V dc.
- Do not measure current while the test leads are in the input jacks.
- Do not apply more than the rated voltage, between the terminals or between each terminal and earth ground.
- Measure a known voltage first to make sure that the Product operates correctly.

HVAC True-rms Clamp Meter
Safety Information

- **Limit operation to the specified measurement category, voltage, or amperage ratings.**
- **The battery door must be closed and locked before you operate the Product.**
- **Remove all probes, test leads, and accessories before the battery door is opened.**
- **Keep fingers behind the finger guards on the probes.**
- **Hold the Product behind the tactile barrier.**
- **Replace the batteries when the low battery indicator shows to prevent incorrect measurements.**
- **Do not use the HOLD function to measure unknown potentials. When HOLD is turned on, the display does not change when a different potential is measured.**
- **Disconnect power and discharge all high-voltage capacitors before you measure resistance, continuity, capacitance, or a diode junction.**
- **Remove the input signals before you clean the Product.**
- **Use only specified replacement parts.**

- **When batteries are changed, ensure that the calibration seal in the battery compartment is not damaged. If damaged, the Product may not be safe to use. Return the Product to Fluke for replacement of the seal.**
- **Do not use in CAT III or CAT IV environments without the protective cap installed. The protective cap decreases the exposed probe metal to <4 mm. This decreases the possibility of arc flash from short circuits.**
- **Have an approved technician repair the Product.**
- **Repair the Product before use if the battery leaks.**
- **Remove the batteries if the Product is not used for an extended period of time, or if stored in temperatures above 50 °C. If the batteries are not removed, battery leakage can damage the Product.**

⚠ Caution

To avoid possible damage to the Product or to equipment under test:

- **Use the proper jacks, function, and range for the measurement application.**
- **Clean the case and accessories with a damp cloth and mild detergent only. Do not use abrasives or solvents.**

HVAC True-rms Clamp Meter
Safety Information

Table 1 lists the symbols used on the Product and in this manual.

Table 1. Symbols















Symbol	Description
	Consult user documentation.
	WARNING. RISK OF DANGER.
	WARNING. HAZARDOUS VOLTAGE. Risk of electric shock.
	Application around and removal from uninsulated hazardous live conductors is permitted.
	AC (Alternating Current)
	DC (Direct Current)
	Both direct and alternating current
	Earth
	Battery. Low battery when shown on display.
	Double Insulated
CAT II	Measurement Category II is applicable to test and measuring circuits connected directly to utilization points (socket outlets and similar points) of the low-voltage MAINS installation.

Table 1. Symbols (cont.)

Symbol	Description
CAT III	Measurement Category III is applicable to test and measuring circuits connected to the distribution part of the building's low-voltage MAINS installation.
CAT IV	Measurement Category IV is applicable to test and measuring circuits connected at the source of the building's low-voltage MAINS installation.
	Conforms to European Union directives.
	Certified by TÜV SÜD Product Service.
	Conforms to relevant Australian EMC standards.
	Certified by CSA Group to North American safety standards.
	This product complies with the WEEE Directive marking requirements. The affixed label indicates that you must not discard this electrical/electronic product in domestic household waste. Product Category: With reference to the equipment types in the WEEE Directive Annex I, this product is classed as category 9 "Monitoring and Control Instrumentation" product. Do not dispose of this product as unsorted municipal waste.

HVAC True-rms Clamp Meter
Product Familiarization

Product Familiarization

Figure 1 and Table 2 show the features of the Product.

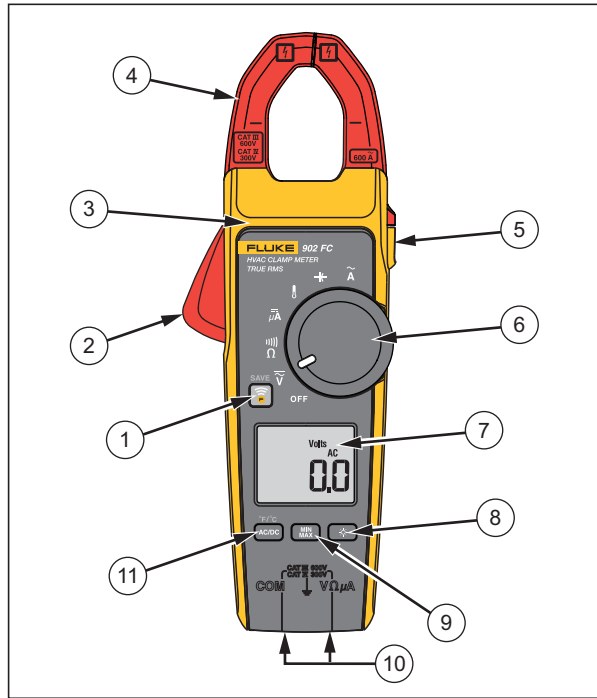

Figure 1. Product Features

iad01.eps

902 FC
Users Manual

Table 2. Product Features

Item	Description
①	Fluke Connect
②	Jaw release
③	Tactile barrier
④	Jaws
⑤	Hold button
⑥	Rotary switch: \tilde{V} AC and DC voltage Ω Resistance and continuity μA DC microamps °F / °C Degrees Fahrenheit / degrees Celsius + Capacitance \tilde{A} AC current OFF Turns off the Product
⑦	Display
⑧	Backlight button
⑨	MIN MAX button
⑩	Input Terminals
⑪	AC/DC, °F/°C button

HVAC True-rms Clamp Meter
Product Familiarization

Table 3 shows the items on the display.

Table 3. Display

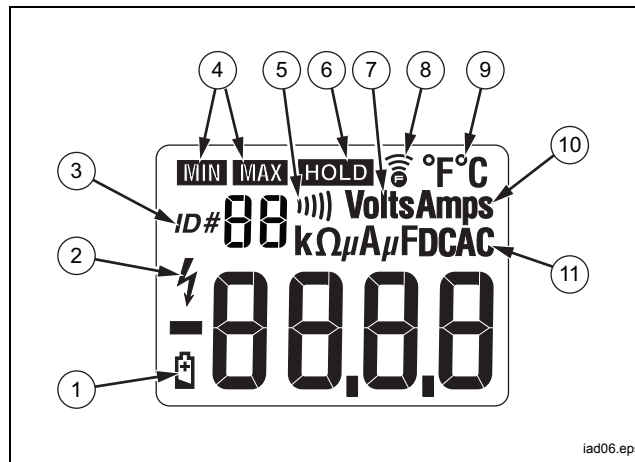

iad06.eps

Item	Description
①	Battery is low and should be changed
②	Indicates the presence of high voltage
③	ID number
④	Indicates minimum or maximum recording mode

Table 3. Display (cont.)

Item	Description
⑤	Beeper
⑥	Display Hold is active
⑦	Volts
⑧	Fluke Connect is enabled
⑨	Degrees (Fahrenheit or Celcius)
⑩	Amps
⑪	Ω Ohms
	μA Microamps
	μF Microfarads
	DC Direct Current
	AC Alternating Current

Use the Product

Measure AC and DC Voltage

1. Insert the test leads into the Product.
2. Turn the rotary switch to \bar{V} .
3. Push **AC/DC** to choose ac or dc voltage.

HVAC True-rms Clamp Meter
Use the Product

The chosen voltage mode shows on the display.

4. Measure the voltage by touching the probes to the correct test points of the circuit.
5. Read the measured voltage on the display.

Note

When a measured voltage is above 30 V, ⚡ shows on the display. When the voltage drops below 30 V, ⚡ disappears.

Measure Resistance and Continuity

⚠⚠ Warning

To avoid false readings that can lead to electrical shock and injury, de-energize the circuit before taking the measurement.

To measure resistance or continuity:

1. Insert the test leads into the Product.
2. Turn the rotary switch to Ω .

902 FC
Users Manual

3. Measure the resistance by touching the probes to the desired test points of the circuit.
4. Read the measured resistance on the display.

Note

If the resistance is $<30 \Omega$, the continuity beeper sounds and indicates a short circuit.

Measure Microamps μA

The μA dc ($\bar{\mu A}$) function on the Product is primarily for HVAC flame rod testing.

To test a heating system flame rod (see Figure 2):

1. Turn the heating unit off.
2. Locate the wire between the gas-burner controller and the flame rod, and break this connection.
3. Turn the rotary switch to $\bar{\mu A}$.
4. Use alligator clips to connect test leads between the flame sensor probe and control-module wire.
5. Turn heating unit on.
6. Read the measured amps on the display.
7. Refer to the heating unit documentation for what the desired value should be.

HVAC True-rms Clamp Meter
Use the Product

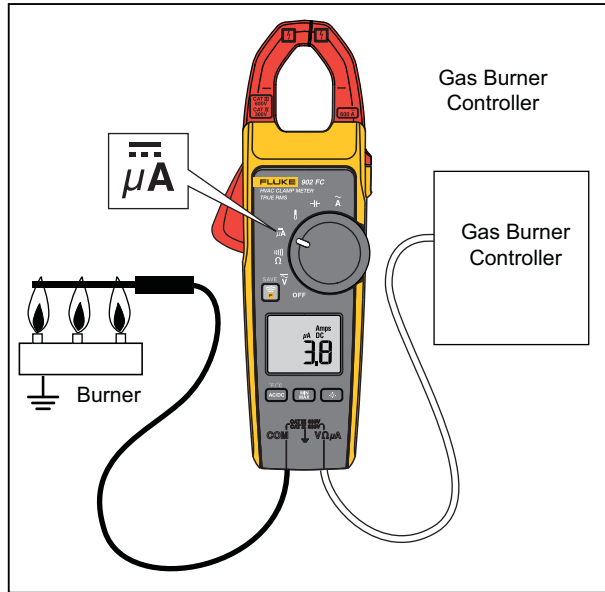

Figure 2. Test a Flame Rod

iad04.eps



Measure Temperature

The Product measures temperature in either Celsius (°C) or Fahrenheit (°F).

⚠⚠ Warning

To prevent possible electrical shock, fire, or personal injury, do not touch voltages >30 V ac rms, 42 V ac peak, or 60 V dc.

To measure temperature (see Figure 3):

1. Connect the Probe to the input jacks noting correct polarity of the probe.
2. Turn the rotary switch to .
3. Push  to select °C or °F.

The chosen temperature mode shows on the display.

4. Position the Probe to take the measurement.
5. Read the measured temperature on the display.

Note

To meet stated accuracy, the Product and plug of the Probe must be at the same temperature.

*HVAC True-rms Clamp Meter
Use the Product*

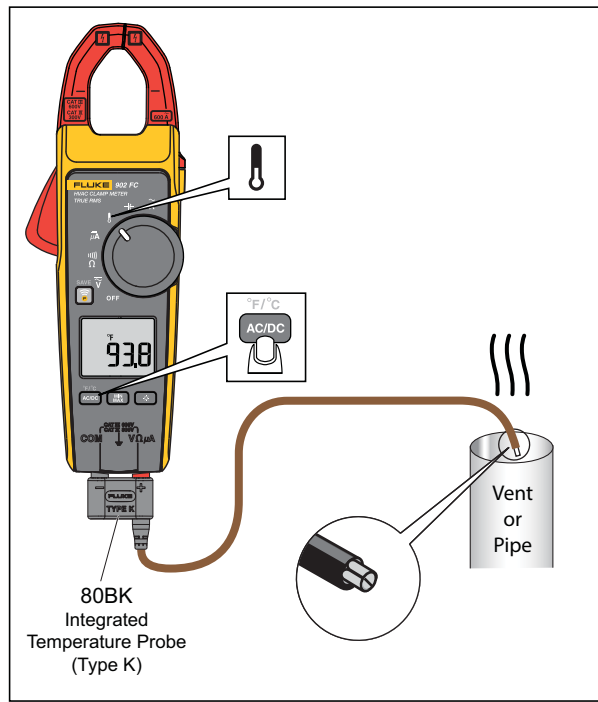

Figure 3. Measure Temperature

Measure Capacitance

1. Turn off power to the circuit.
2. Disconnect and discharge the capacitor.
3. Turn the rotary switch to $\text{—} \overline{\text{C}}$.
4. Take the measurement noting the correct polarity of the capacitor.

If the capacitor requires more discharging, **diSC** shows while the capacitor discharges.

Measure AC Current

⚠⚠ Warning

To prevent possible electrical shock, fire, or personal injury:

- **Remove Test Leads before making current measurements.**
- **Do not hold the Product anywhere beyond the tactile barrier (see Figure 4).**

1. Turn the rotary switch to $\tilde{\text{A}}$.
2. Center the wire within the clamp jaws below the horizontal line located on the clamp (see Figure 4).

Note

Measure one wire at a time because currents moving in different directions will cancel each other out (see Figure 4).

HVAC True-rms Clamp Meter
Use the Product

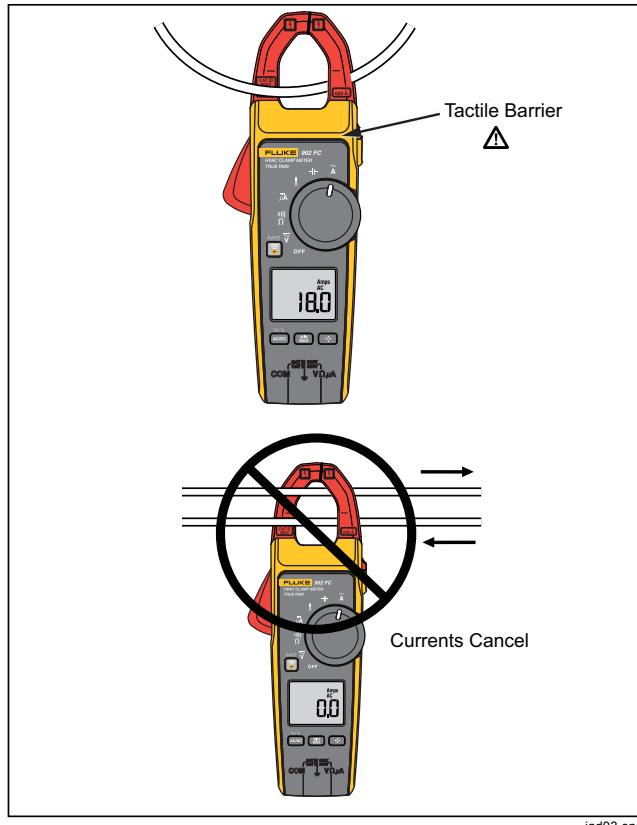





Figure 4. Proper AC Current Measurement

iad03.eps

Backlight

Push  to toggle the backlight on and off. The backlight automatically turns off after 2 minutes.







To disable the automatic backlight timeout:

1. Hold  and turn on the Product.
2. Push .

MIN MAX Recording Mode

The MIN MAX recording mode captures the minimum and maximum input values. When a new high or low is detected, the Product beeps.

To use this feature:

1. Turn the rotary switch to the desired measurement function.
2. Push  to enter MIN MAX Mode.
 and the highest reading detected since entering MIN MAX mode show on the display.
3. Push  to step through the minimum (**MIN**) and present readings.
4. To pause MIN MAX recording without erasing stored values, push  **HOLD** shows on the display.
5. To resume MIN MAX recording, push  again.
6. To exit MIN MAX mode and erase stored readings, push  for at least 2 seconds.

Display HOLD

In the Display HOLD mode, the Product freezes the display. The Product also beeps every 4 seconds and **HOLD** flashes to remind the user.

⚠⚠ Warning

To avoid possible electric shock or personal injury, do not use the HOLD function to measure unknown potentials. When HOLD is turned on, the display does not change when a different potential is measured.

1. Push **HOLD** to activate Display HOLD.
HOLD shows on the display, and the reading is stored.
2. To exit and return to normal operation, push **HOLD**.

Auto Off

The Product automatically turns off after 20 minutes. To restart the Product, turn the rotary switch to **OFF** and then back on. Auto Off is disabled during MIN MAX mode.

To disable Auto Off:

1. Hold **AC/DC** and turn on the Product.
2. Push **HOLD**.

Maintenance

⚠⚠ Warning

To prevent possible electrical shock, fire, or personal injury:

- Have an approved technician repair the Product.
- Use only specified replacement parts.

Clean the Product

⚠⚠ Warning

To prevent possible electrical shock, fire, or personal injury, remove the input signals before you clean the Product.

⚠ Caution

To avoid damage to the Product, do not use aromatic hydrocarbons or chlorinated solvents to clean the Product. These solutions will react with the plastics used in the Product.

Clean the instrument case with a damp cloth and mild detergent.

Battery Replacement

⚠⚠ Warning

To prevent possible electrical shock, fire, or personal injury:

- Remove all probes, test leads, and accessories before the battery door is opened.
- Remove the batteries if the Product is not used for an extended period of time, or if stored in temperatures above 50 °C. If the batteries are not removed, battery leakage can damage the Product.
- Replace the batteries when the low battery indicator shows to prevent incorrect measurements.
- The battery door must be closed and locked before you operate the Product.
- When batteries are changed, ensure that the calibration seal in the battery compartment is not damaged. If damaged, the Product may not be safe to use. Return the Product to Fluke for replacement of the seal.
- Repair the Product before use if the battery leaks.

902 FC
Users Manual

To replace the batteries (see Figure 5):

1. Turn the rotary switch to **OFF**.
2. Remove the test leads from the terminals.
3. Loosen the battery door fastener and remove the door from the case bottom.
4. Remove the batteries.
5. Replace the batteries with two new AA batteries.
6. Reattach the battery door to the case bottom and tighten the fastener.

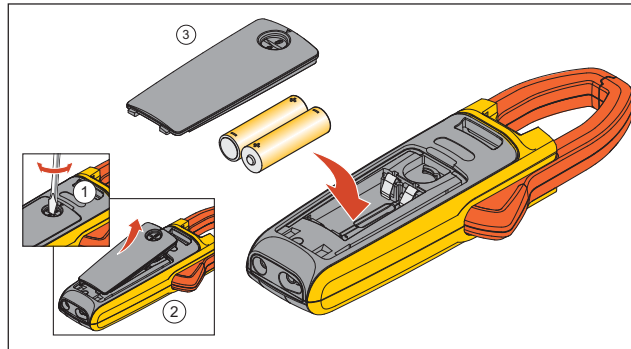

Figure 5. Battery Replacement

iad12.eps

HVAC True-rms Clamp Meter
Replacement Parts

Replacement Parts

Table 4 lists the replacement parts.

Table 4. Replacement Parts

Item	Qty.	Part Number
Battery, AA 1.5 V	2	376756
Battery Door Assembly	1	4696918
TL75 Test lead set	1	4306653
80BK Thermocouple set, K-type	1	1997234
Softcase	1	1997276

Fluke Connect

Figure 6 shows how to use Fluke Connect with the Product.

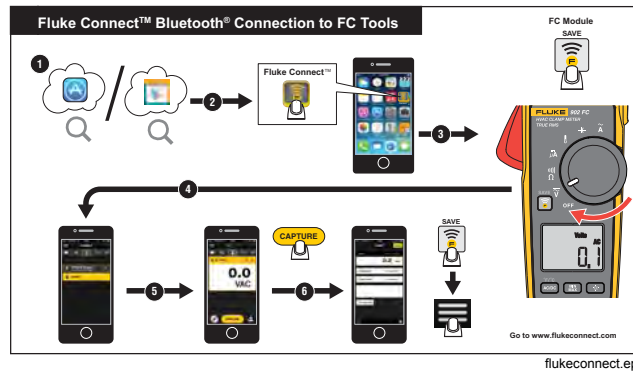

Figure 6. Fluke Connect Operation

Specifications

Electrical Specifications

Function	Range	Resolution	Accuracy
Voltage DC	600 V	0.1 V	1.0 % ±5 counts
Voltage AC (True-rms)	600 V	0.1 V	1.5 % ±5 counts, (45 Hz to 400 Hz)
Current AC (True-rms)	600 A	0.1 A	2.0 % ±5 counts, (45 Hz to 65 Hz) 2.5 % ±5 counts, (65 Hz to 400 Hz) Max Crest Factor (50 Hz/60 Hz) 3 @ 180 A 2.5 @ 220 A 1.42 @ 600 A Note: Add 2 % for C.F. >2
Current DC	200 μ A	0.1 μ A	1.0 % ±5 counts
Resistance	600 Ω	0.1 Ω	1.0 % ±5 counts
	6000 Ω	1 Ω	
	60 k Ω	0.01 k Ω	
Continuity	<30 Ω	--	--
Temperature	-40 °C to 400 °C	0.1 °C	1.0 % ±8 counts
Capacitance	100 μ F	0.1 μ F	1.0 % ±4 counts
	1000 μ F	1 μ F	

**HVAC True-rms Clamp Meter
Specifications**

General Specifications

Operating Temperature	-10 °C to +50 °C
Storage Temperature	-30 °C to +60 °C, without batteries installed
Operating Humidity	Non condensing (<10 °C) ≤90 % RH (10 °C to 30 °C) ≤75 % RH (30 °C to 40 °C) ≤45 % RH (40 °C to 50 °C)
Operating Altitude	2000 meters above mean sea level
Storage Altitude	12,000 meters above mean sea level
IP Rating	IEC 60529: IP30
Radio Frequency Certification	FCC ID:T68-FBLE IC:6627A-FBLE
Wireless Radio Frequency Range	2412 MHz to 2483.5 MHz
Temperature Coefficients	0.1 x (specified accuracy) / °C (<18 °C or >28 °C)
Size (H X W X L)	(230 x 83.7 x 45.4) mm (9.1 x 3.3 x 1.8) inches
Weight	0.84 lb (382 g)
Safety	IEC 61010-1, Pollution Degree 2 IEC 61010-2-032: CAT III 600 V / CAT IV 300 V IEC 61010-2-033: CAT III 600 V / CAT IV 300 V

902 FC
Users Manual

Power Requirements	Two AA Batteries, IEC LR6
Electromagnetic Compatibility (EMC)	
International	IEC 61326-1: Portable Electromagnetic Environment; IEC 61326-2-2; CISPR 11: Group 1, Class A
<i>Group 1: Equipment has intentionally generated and/or uses conductively-coupled radio frequency energy that is necessary for the internal function of the equipment itself.</i>	
<i>Class A: Equipment is suitable for use in all establishments other than domestic and those directly connected to a low-voltage power supply network that supplies buildings used for domestic purposes. There may be potential difficulties in ensuring electromagnetic compatibility in other environments due to conducted and radiated disturbances. Emissions that exceed the levels required by CISPR 11 can occur when the equipment is connected to a test object.</i>	