

## Toolmakers' Microscopes TM Series

Optical Measuring

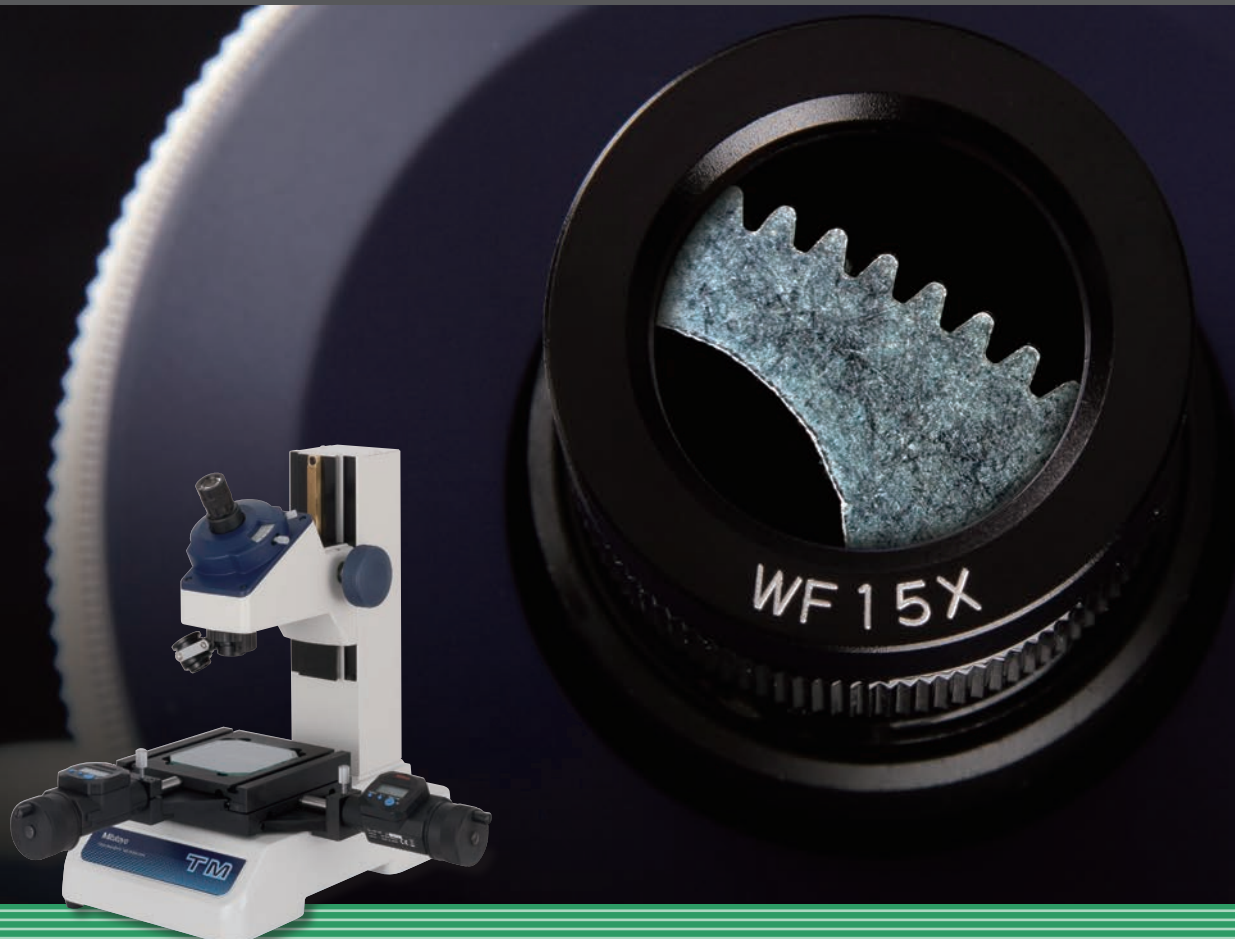

# Bright and Clear Field of View. Best Performance in Small-model Class.

- Newly designed LED illuminators provide enhanced observation for higher accuracy and resolution.



Conventional illumination



Newly designed LED illumination

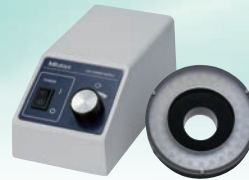

Optional LED circular illuminator available for applications requiring all-round lighting.  
**176-208A**

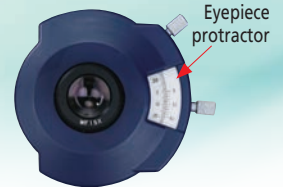

A vernier scale mounted outside the eyepiece enables simple angle measurement.

## Optional Accessories

Eyepieces and Objectives see page 4

Order No.	Description
64AAB429	MOTICAM 2, 2.0 MEGAPIXEL-1/3" CMOS, USB
64AAB529	MOTICAM 3+, 3.0 MEGAPIXEL-1/2" CMOS, USB
64AAB431	MOTICAM 5, 5.0 MEGAPIXEL-1/2.5" CMOS, USB
64AAB526	MOTICAM 1080, 2.0 MEGAPIXEL-1/2.8" CMOS, USB/HDMI
63AAA060	.37x C-Mount Eyetube Adapter



LED ring light  
**64AAB214**



Digimatic Micrometer Heads (LCD readout)  
**164-164**



(Two units are required for an XY table.)

## SPECIFICATIONS

Model No.	TM-505B	TM-A505B	TM-1005B	TM-A1005B
Order No.	176-818A	176-820A	176-819A	176-821A
Optical tube	Monocular type (Vertical tilt angle: 60°)			
Observation image	Erect			
Eyepiece protractor	Resolution (graduation) : 1°, Rotation angle: 360°, Resolution (angle): 6', Adjustable zero point			
Eyepiece	Standard accessory: 15X (field number: 13), Options: 10X, 20X			
Objective lens	Standard accessory: 2X, Options: 5X, 10X			
Microscope head	Maximum height of workpiece	4.53" / 115mm		4.21" / 107mm
	Focusing method	Manual (Coarse feed)		
Illumination unit	Transmitted illumination	Stepless brightness adjustment, White LED light source, With green filter		
	Surface illumination	Oblique single-source type, Stepless brightness adjustment, White LED light source		
Cross-travel stage	Measuring range	2" x 2" / 50x50mm		4" x 2" / 100x50mm (An optional 2"/50mm gauge block is required to cover full range. A CERA block is recommended.)
	Table size	6" x 6" / 52x152mm		9.44" x 6" / 240x152mm
	Usable area of the stage glass	3.8" x 3.8" / 96x96mm		6" x 3.8" / 154x96mm
	Maximum stage glass loading	11 lbs. / 5kg		
Linear measurement method	Micrometer heads optional	Micrometer heads included	Micrometer heads optional	Micrometer heads included
Resolution	N/A	.00005"/1μm	N/A	.00005"/1μm
Micrometer head travel range	N/A	2"/50mm	N/A	2"/50mm
Power supply	120VAC Maximum power consumption: 4.2W			
Main unit mass	31 lbs. / 14kg		33 lbs. / 15kg	



**TM-A505B**  
**176-820A**



**TM-A1005B**  
**176-821A**

(Micrometer heads shown are optional on other models)

## DIMENSIONS (including digital micrometer heads)

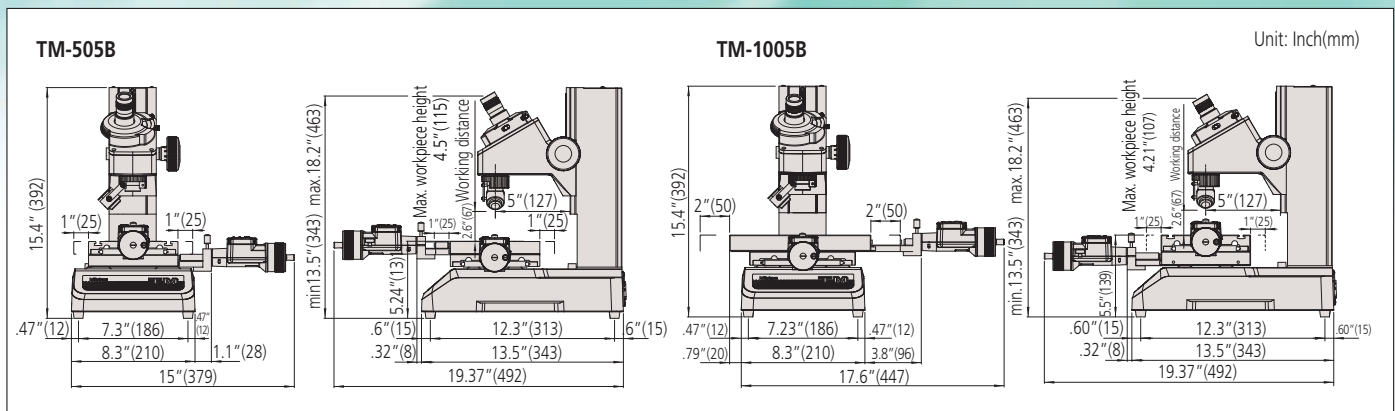

## System configuration (accessories are optional)

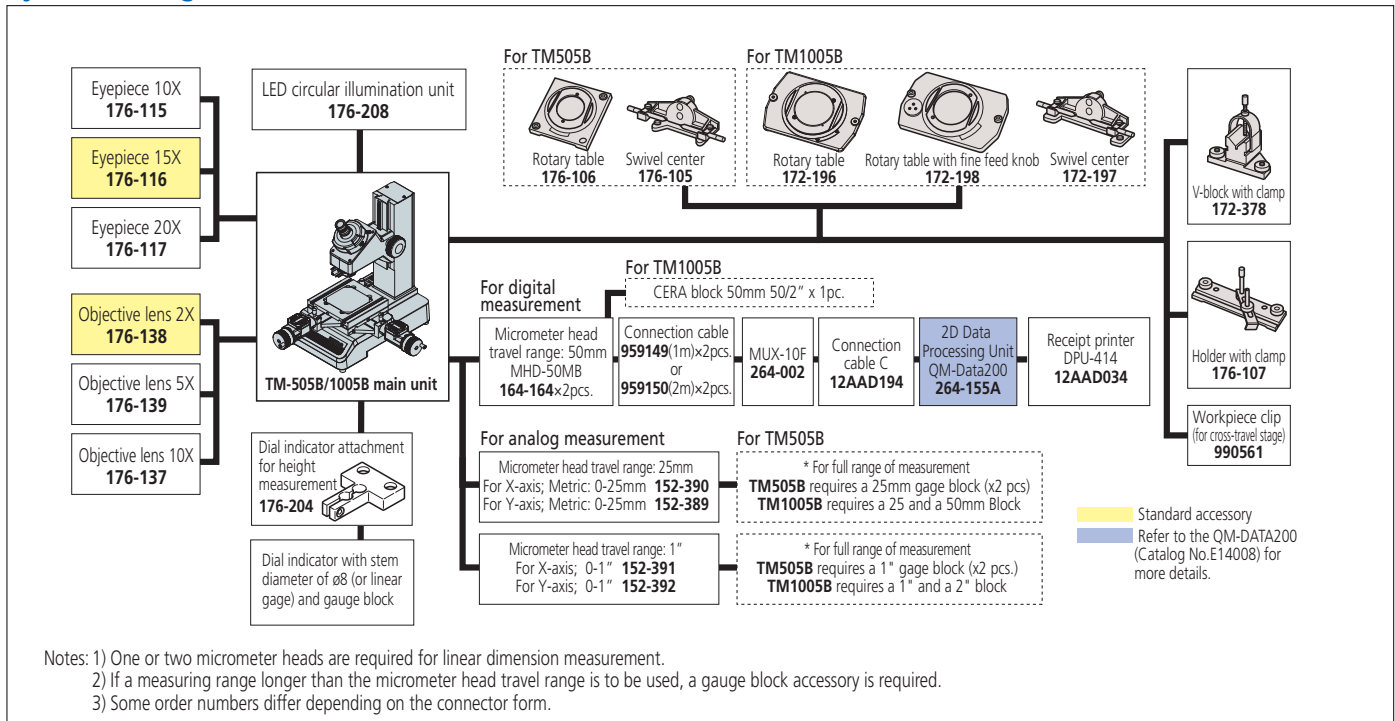



# Eyepiece-Objective Performance Table

	Eyepiece 10X (176-115)			Eyepiece 15X (Standard accessory)			Eyepiece 20X (176-117)		
	Total magnification	Viewing field	Depth of focus	Total magnification	Viewing field	Depth of focus	Total magnification	Viewing field	Depth of focus
Objective 2X (Standard accessory)	20X	ø.256" (ø6.5mm)	158µm	30X	ø.256" (ø6.5mm)	124µm	40X	ø.197" (ø5mm)	107µm
Objective 5X (176-139)	50X	ø.102" (ø2.6mm)	56µm	75X	ø.102" (ø2.6mm)	47µm	100X	ø.079" (ø2mm)	42µm
Objective 10X (176-137)	100X	ø.051" (ø1.3mm)	24µm	150X	ø.051" (ø1.3mm)	21µm	200X	ø.039" (ø1mm)	19µm

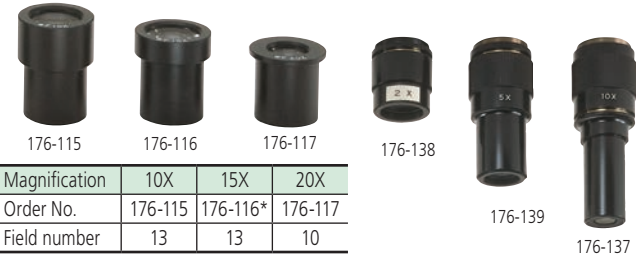

Magnification	10X	15X	20X
Order No.	176-115	176-116*	176-117
Field number	13	13	10

\*Standard accessory

Magnification	2X	5X	10X
Order No.	176-138*	176-139	176-137
Numerical aperture	0.07	0.10	0.14
Working distance	2.638" (67mm)	1.299" (33mm)	.551" (14mm)

\*Standard accessory

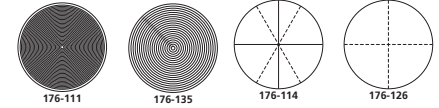

Reticles	
176-111	concentric circle (up to ø4mm, 0.05mm increment)
176-135	concentric circle (up to ø2mm, .01" increment)
176-114	60° angle
176-126	90° broken cross-hair* (Standard accessory)

© 2015 Mitutoyo America Corporation

Coordinate Measuring Machines	Vision Measuring Systems	Form Measurement	Optical Measuring
Sensor Systems	Test Equipment and Seismometers	Digital Scale and DRO Systems	Small Tool Instruments and Data Management

Whatever your challenges are, Mitutoyo supports you from start to finish.

Mitutoyo is not only a manufacturer of top-quality measuring products but one that also offers qualified support for the lifetime of the equipment, backed by comprehensive services that ensure your staff can make the very best use of the investment.

Apart from the basics of calibration and repair, Mitutoyo offers product and metrology training, as well as IT support for the sophisticated software used in modern measuring technology. We can also design, build, test and deliver measuring solutions and even, if deemed cost-effective, take your critical measurement challenges in-house on a sub-contract basis.



Find additional product literature and our product catalog

# Mitutoyo

**Note:** All information regarding our products, and in particular the illustrations, drawings, dimensional and performance data contained in this printed matter as well as other technical data are to be regarded as approximate average values. We therefore reserve the right to make changes to the corresponding designs. The stated standards, similar technical regulations, descriptions and illustrations of the products were valid at the time of printing. In addition, the latest applicable version of our General Trading Conditions will apply. Only quotations submitted by ourselves may be regarded as definitive. Specifications are subject to change without notice.

Mitutoyo products are subject to US Export Administration Regulations (EAR). Re-export or relocation of our products may require prior approval by an appropriate governing authority.

**Trademarks and Registrations**

Designations used by companies to distinguish their products are often claimed as trademarks. In all instances where Mitutoyo America Corporation is aware of a claim, the product names appear in initial capital or all capital letters. The appropriate companies should be contacted for more complete trademark and registration information.