

## Series 1000 and Series 2000 Installation Manual



WEB VERSION

PK-93856-10-00-08

## TABLE OF CONTENTS

<b>1 Product Description</b> .....	<b>5</b>
1.1 General Description.....	5
1.2 Meter Features.....	5
1.3 Meter Certifications.....	5
1.4 Physical Description.....	5
<b>2 Technical Specifications</b> .....	<b>7</b>
2.1 Electrical Specifications	
Table 1 - Series 1000 Electrical Specifications.....	7
Table 2 - Series 2000 Electrical Specifications.....	8
2.2 Input/Output Connections and User Display.....	9
2.3 Display Specifications.....	11
<b>3 Installation Instructions</b> .....	<b>12</b>
3.1 Explanation of Warning Symbols.....	12
3.2 Safety Precautions.....	12
3.3 Preparation.....	13
3.4 List of Materials.....	13
3.5 Mounting the Enclosure.....	13
3.5.1 Selecting a Mounting Location.....	13
3.5.2 Conduit Openings.....	14
3.5.3 Mounting Procedure and Conduit Installation.....	14
3.6 Installation of Voltage Lines.....	15
3.7 Installation of Current Transformers.....	16
General Requirements.....	16
Installing Solid Core CTs.....	17
Installing Split Core CTs.....	17
Figure 7: 1-phase, 2-wire Hookup Diagram.....	18
Figure 8: 1 or 2 phase, 3 wire Hookup Diagram.....	19
Figure 9: 3-phase, 4-wire WYE Hookup Diagram.....	20
3.8 Testing the Installation.....	21
Testing Voltage.....	21
CT Reverse Phase Indicator.....	21
Load LEDs.....	21
LCD Display.....	21
3.9 Securing the Enclosure.....	21
<b>4 Maintenance</b> .....	<b>22</b>
<b>5 Troubleshooting/FAQ</b> .....	<b>22</b>

WEB VERSION

## TABLE OF CONTENTS

### List of Figures

Figure 1: Steel Enclosure Dimensions .....	5
Figure 2: Plastic Enclosure Dimenstions .....	6
Figure 3: Series 1000/2000 I/O Connections .....	9
Figure 4: Mounting the Enclosure.....	15
Figure 5: Leviton Solid Core CTs.....	16
Figure 6: Leviton Split Core CTs.....	17
Figure 7: 1-phase, 2-wire Hook up Diagram.....	18
Figure 8: 1 or 2-phase, 3-wire Hookup Diagram .....	19
Figure 9: 3-phase, 4-wire WYE Hookup Diagram .....	20

### List of Tables

Table 1: Series 1000 Electrical Specficiation .....	7
Table 2: Series 2000 Electrical Specficiation .....	8
Table 3: I/O connections and Status Indicators .....	10

**WEB VERSION**

## 1 PRODUCT DESCRIPTION

### 1.1 General Description

The Leviton Series 1000 and 2000 meters are self-powered; current transformer (CT) rated electronic kilowatt-hour (kWh) meters designed for permanent connection to an electrical service.

- Series 1000 meters are designed for 1-phase, 2-wire and 1 or 2-phase, 3-wire services, whereas Series 2000 meters are designed for 3-phase, 4-wire services.
- This guide is for use with individual Series 1000 and 2000 units.
- These meters are suitable for WYE configurations only

### 1.2 Meter Features

- Revenue-grade accuracy with solid-core CTs
- Use with 100mA solid core, or easy to install split core CTs
- Built in LCD that displays kWh data
- AMR compatible isolated pulse outputs
- Reverse-phase diagnostic indicator
- 5-year warranty

### 1.3 Meter Certifications

- UL Listed in the US and Canada
- Conforms to accuracy requirements set forth in ANSI C12.10
- Series 2000 meters are California CTEP approved with 100A and 200A solid core CTs.

### 1.4 Physical Description

Single Series 1000 and Series 2000 meters are available in two enclosures:

1. Industrial grade JIC steel enclosures for indoor installations shown in Figure 1

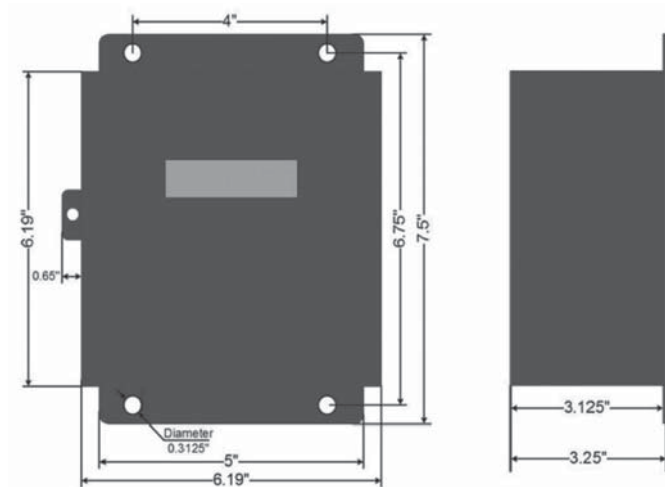

Figure 1 - Steel enclosure dimensions

1 PRODUCT DESCRIPTION

2. Plastic NEMA 4X enclosures, shown in Figure 2

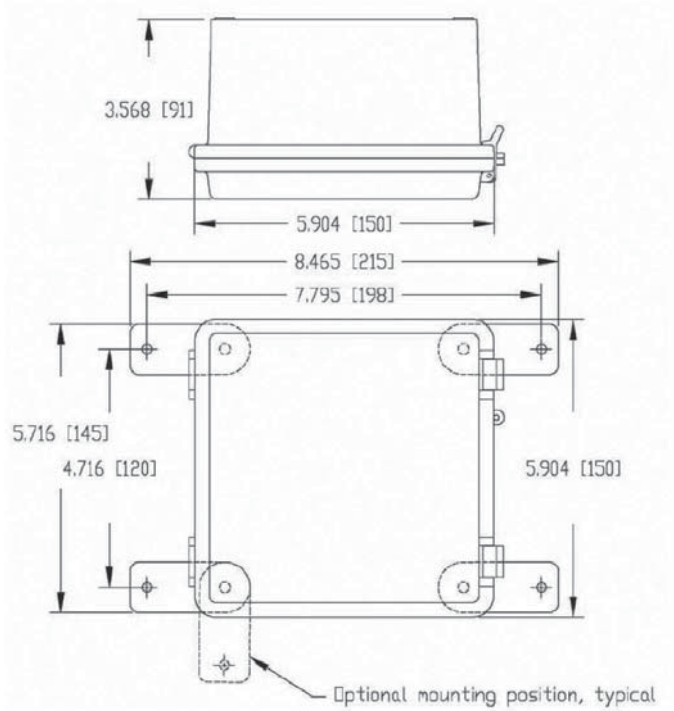

Figure 2 - Plastic enclosure dimensions

WEB VERSION

## 2 TECHNICAL SPECIFICATIONS

### 2.1 Electrical Specifications

Series 1000 and Series 2000 Meters fall under UL Circuit Category III: a device for measurements performed in the building installation. The electrical and environmental specifications for Series 1000 and Series 2000 meters are given in Table 1 and Table 2 below:

**Series 1000 Electrical Specifications**

Input Configurations	1 Phase, 2 Wire (120V or 277V)	1 or 2 Phase, 3 Wire (120/208V, 120/240V, or 277/480V)
Supply Voltage Range (Line to Neutral)	102-138VAC 235-320VAC	102-138VAC 235-320VAC
Maximum Input Power	7VA	7VA
Maximum Rated Current	Primary: Max Operating Current + 10% Secondary: 0.12A	Primary: Max Operating Current + 10% Secondary: 0.12A
Line Frequency	50-60Hz	50-60Hz
Power Factor Range	0.5 to 1.0 Leading or Lagging	0.5 to 1.0 Leading or Lagging
Accuracy <sup>1</sup>	+/- 0.5% of registration @ 1.0 PF, 1% to 100% of rated current +/- 0.75% of registration @ 0.5 PF, 1% to 100% of rated current	+/- 0.5% of registration @ 1.0 PF, 1% to 100% of rated current +/- 0.75% of registration @ 0.5 PF, 1% to 100% of rated current
Meter Operating Temperature	-30 to 60° C	-30 to 60° C
Display Operating Temperature	-20 to 50° C	-20 to 50° C
Rated Pollution Degree <sup>2</sup>	2	2
Rate Relative Humidity	80%	80%
Terminal Block Torque Ratings: Voltage Terminal CT and I/O Terminal	12 in-lb max 4.4 in-lb max	12 in-lb max 4.4 in-lb max

**Table 1 - Series 1000 Electrical Specifications**

<sup>1</sup>Accuracy based on Leviton solid core current transformers (included), with 100 mA secondary output. Meter input burden resistance at 2 Ohms

<sup>2</sup>Pollution Degree 2: Normally only non-conductive pollution occurs. Occasionally, however, a temporary conductivity caused by condensation must be expected.

## 2 TECHNICAL SPECIFICATIONS

### Series 2000 Electrical Specifications

Input Configurations	3Phase, 4 Wire (120/208V or 277/480V)
Supply Voltage Range (Line to Neutral)	102-138VAC 235-320VAC
Maximum Input Power	7VA
Maximum Rated Current	Primary: Max Operating Current + 10% Secondary: 0.12A
Line Frequency	60Hz
Power Factor Range	0.5 to 1.0 Leading or Lagging
Accuracy <sup>1</sup>	+/- 0.5% of registration @ 1.0 PF, 1% to 100% of rated current +/- 0.75% of registration @ 0.5 PF, 1% to 100% of rated current
Meter Operating Temperature	-30 to 60° C
Display Operating Temperature	-20 to 50° C
Rated Pollution Degree <sup>2</sup>	2
Rate Relative Humidity	80%
Terminal Block Torque Ratings: Voltage Terminal CT and I/O Terminal	12 in-lb max 4.4 in-lb max

**Table 2 - Series 2000 Electrical Specifications**

<sup>1</sup>Accuracy based on Leviton solid core current transformers (included), with 100 mA secondary output.  
Meter input burden resistance at 2 Ohms

<sup>2</sup>Pollution Degree 2: Normally only non-conductive pollution occurs. Occasionally, however, a temporary conductivity caused by condensation must be expected.

## 2 TECHNICAL SPECIFICATIONS

### 2.2 Input/Output Connections and User Display

The input and output terminals for Series 1000 and Series 2000 meters are shown below in Figure 3. For hookup diagrams and wiring information refer to section 3.

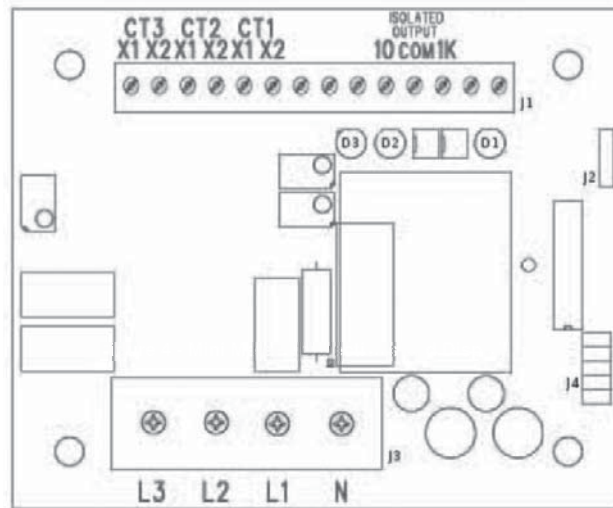

Figure 3: Series 1000/2000 I/O Connections



## 2 TECHNICAL SPECIFICATIONS

Voltage Inputs	Description
L3	Voltage Input Line 3
L2	Voltage Input Line 2 (3-wire and 4-wire models only)
L1	Voltage Input Line 1
N	Neutral Input (Meter powered from L1 & N)
CT Inputs (J1, Left Side)	
CT3: X1	Current Transformer input CT3 Colored wire of CT3 (4 wire models only)
CT3: X2	Current Transformer input CT3. White wire of CT3 (4 wire models only)
CT2: X1	Current Transformer input CT2. Colored wire of CT2 (3-wire and 4-wire models only)
CT2: X2	Current Transformer input CT2. White wire of CT2 (3-wire and 4-wire models only)
CT1: X1	Current Transformer input CT1. Black or colored wire of CT2
CT1: X2	Current Transformer input CT2. White wire of CT1
CT Inputs (J1, Right Side)	
10, Isolated Output (10 Wh/P, Kh = 10)	Isolated pulse output: 5 watt/hours on, 5 watt/hours off, referenced to ISOL COM
COM, Isolated Output	Isolated common for 10/1000 isolated outputs
1K, Isolated Output (1 kWh/P, Kh = 1000)	Isolated pulse output: 500 watt/hours on, 500 watt/hours off, referenced to ISOL COM
1 kWh LED (D3 – Green)	50% duty cycle (at constant load) LED with a pulse rate of 1 kWh per on/off cycle (500 watt/hours on, 500 watt/hours off). In the absence of a significant load, the LED could be on, or off.
10 Wh LED (D2 – Green)	50% duty cycle (at constant load) LED with a pulse rate of 10 Wh per on/off cycle (5 watt/hours on, 5 watt/hours off). In the absence of a significant load, the LED could be on, or off.
Reverse Phase LED (D1 – Red)	Illuminates when a problem with meter phasing exists. In the absence of a significant load, the LED could be on or off. See section 3.7 for CT installation instructions.

## 2 TECHNICAL SPECIFICATIONS

### 2.3 Display Specifications

#### 2.3.1 General Display Information

Series 1000 and 2000 meters provide active energy measurements, which are displayed on the LCD in 1 kWh resolution. These values are cumulative and are cannot be reset. When configured with the energy demand option, the meters provide instantaneous readings on the integrated LCD. These values are displayed one at a time, for six seconds each, as follows:

- Total Active Energy, in kWh (1 kWh resolution, cumulative, non-resettable)
- Instantaneous Demand, in Kilowatts (last 5 minute average, 1/100 kW resolution)
- Peak Demand: Kilowatts (15 minute rolling demand interval, 1/100 kW resolution)

A dot in the LCD aligns with an arrow on the display label to differentiate between instantaneous and peak demand. After displaying peak demand and before displaying total energy, the meter tests the LCD by activating all segments simultaneously for one second.

#### 2.3.2 Resetting the Peak Demand (optional additional feature)

An additional optional feature is the Peak Demand reset. Meters configured with the Peak Demand Reset option have an integrated key switch which is used to reset the peak demand. A demand reset command will only be recognized during the period when the peak demand is displayed on the LCD. In order to reset the demand, a pulse must be generated by turning the key switch from locked position (arrow up) to the right and then back to the original position. This back and forth transition triggers a demand reset. The maximum transition period is one second. Multiple key switch transitions during the peak demand display interval may be required to reset peak demand.

WEB VERSION

### 3 INSTALLATION INSTRUCTIONS

The following section contains installation and wiring instructions for the Leviton Series 1000, and Series 2000 meters in either the indoor or outdoor enclosure. If technical assistance is required at any point during the installation, contact information can be found at the end of this manual. Leviton is not responsible for damage to the meter caused by incorrect wiring.

#### 3.1. Explanation of Warning Symbols



Indicates the need to consult the operation manual due to the presence of a potential risk.



Indicates the presence of electric shock hazards. Prior to proceeding, de-energize the circuit and consult the operation manual.



Indicates that the equipment is protected throughout by double insulation.

#### 3.2. Safety Precautions

##### **WARNING**

- **Installation of electric meters requires working with possibly hazardous voltages. These instructions are meant to be a supplement to aid trained, qualified professionals. Failure to follow these warnings could result in death or injury.**
- **TO AVOID FIRE, SHOCK, OR DEATH, turn off all power supplying the equipment before performing any wiring operations. Use a properly rated voltage sensing device to confirm power is off.**
- **Bonding is not automatic for metal conduit connections; separate bonding is to be provided.**
- **Installations should be done in accordance with local codes and current National Electric Code requirements.**
- **Equipment used in a manner not specified by this document impairs the protection provided by the equipment.**

### 3 INSTALLATION INSTRUCTIONS

#### 3.3 Preparation

- Verify the model number and electrical specifications of the device being installed to confirm they are appropriate for the intended electrical service (see Section 2).
- Consult local codes for any possible permits or inspections required before beginning electrical work.
- Ensure the conduit for the installation is appropriate for the intended application. UL Type 4x conduit and conduit fittings required for outdoor applications.
- Make sure all tools to be used during installation have proper insulation ratings.
- Look at the Meter and inside the electrical panel for possible exposed wire, broken wire, damaged components or loose connections.

#### 3.4 List of Materials

- Series 1000 or Series 2000 meter, enclosure and associated mounting materials
- Line 1, Line 2, Line 3 and Neutral hook-up wires as needed for the electrical service.
- Wires must be 18 AWG or larger and insulated for 600 VAC min. Meter terminals will accept wiring up to 14 AWG.
- Current Transformers (CTs): This product is designed for use with Leviton 100mA series of solid and split core CTs.
- Conduit and fittings as appropriate. UL Type 4X conduit and fittings must be used for outdoor applications to maintain the rating of the installation.

#### 3.5 Mounting the Enclosure

##### 3.5.1 Selecting a Mounting Location

- Series 1000 and 2000 meters require a switch or circuit breaker as part of the building installation.
- The switch or circuit breaker must be marked as the disconnecting device for the meter.
- It is recommended that the enclosure be mounted near the disconnecting device in an area with adequate ventilation.
- The enclosure should not be positioned in a manner that makes it difficult to operate the disconnecting device.
- Ensure that the CT and voltage lead lengths (and conduit lengths) are capable of reaching the enclosure from the load center.
- If a suitable mounting location near the load center cannot be found, additional in-line fuses or circuit breaker may be required in accordance with NEC regulations.

### 3 INSTALLATION INSTRUCTIONS

#### 3.5.2 Conduit Openings

##### Steel Enclosure

The Series 1000 and 2000 steel enclosure comes with a 1 1/16" knockout (3/4" conduit) on the bottom of the enclosure, and a 7/8" knockout (1/2" conduit) on top of the enclosure. To remove a knockout, use a flathead screwdriver (or other rigid device) to puncture the indentations first, and then pry off and discard the knockout.

##### Outdoor Enclosure

The bottom panel and lower half of the side panels work best for conduit opening locations in outdoor single meter enclosures. Select the location that makes wire installation easiest for the given environment. If the side panels are used, holes should be centered approximately half an inch from the bottom of the enclosure. Hole sizes must be appropriate to fittings, and large enough to fit all voltage and CT wiring (4-10 18 AWG min. wires insulated for 600 V min.). Care should be exercised to keep drill bit away from components inside the enclosure. **UL Type 4X conduit and fittings must be used in order to maintain the outdoor rating of the enclosure.**

#### 3.5.3 Mounting Procedure and Conduit Installation

1. For outdoor enclosures, attach the mounting brackets to the back of the enclosure with the four provided screws as shown in Figure 4.
2. Fasten the enclosure to the selected surface using the provided mounting holes (steel enclosure) or mounting brackets (plastic enclosure).
3. Verify that the enclosure is not loose and that all connections are secure.
4. Attach the conduit between enclosure and load center, routing wires as necessary for later use.
5. Make sure the conduit fittings are aligned properly and tightened securely to prevent moisture from entering the enclosure (outdoor applications).

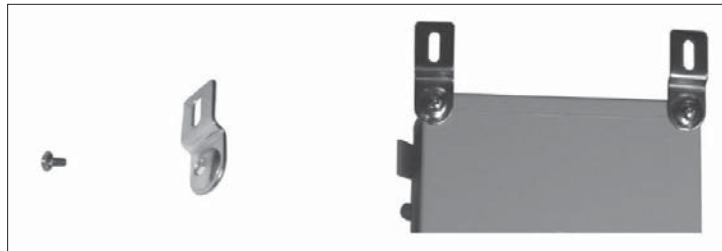

Figure 4 - Mounting the Enclosure

### 3 INSTALLATION INSTRUCTIONS

#### 3.6 Installation of Voltage Lines



TO AVOID FIRE, SHOCK OR DEATH, make sure service is disconnected before any connections are made.



Voltage connections must be made in accordance with NEC Section 240 and all other local electrical code requirements.

1. Connect 18 AWG min., 600 V min. insulated wiring for Line voltages and Neutral to the appropriate locations in the breaker panel, in accordance with all national and local electrical codes.
2. Route wires through the conduit if not already done.
3. Trim the wire to the appropriate length to avoid coils of excess wiring.
4. Strip wiring to approximately .300 inches if needed and connect to the appropriate terminals. Wires should be tightened so that they are held snugly in place, but do not to over-tighten, as this may compress and weaken the conductor.

### 3 INSTALLATION INSTRUCTIONS

#### 3.7 Installation of Current Transformers



TO AVOID FIRE, SHOCK OR DEATH, always open or disconnect the circuit from the power distribution system of a building before installing or servicing current transformers.



In accordance with NEC, CTs may not be installed in any panel board where they exceed 75% of the wiring space of any cross-sectional area.

##### General Requirements:

- Splices on the CT leads must be within the meter enclosure, not inside the conduit. Leviton CTs come with standard 48inch leads. Wire insulation should be stripped so that the bare conductor length that connects to the meter terminal block does not exceed 0.300 inches.
- CTs should be securely fastened such that they will not slide down to live terminals.
- Wires should be tightened so that they are held snugly in place, but do not to over-tighten, as this may compress and weaken the conductor.
- Current and voltage inputs must be installed 'in phase' for accurate readings (e.g. CT1 on Line 1, CT2 on Line 2) Orientation is critical. Ensure that all CTs are properly oriented with the line and load, as marked.

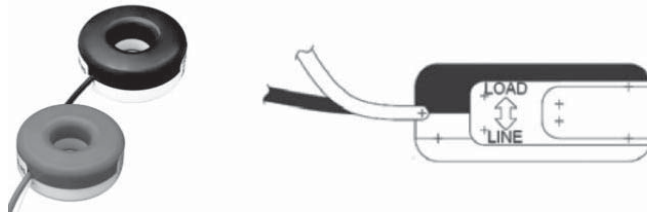

Figure 5: Leviton solid core CTs

WEB VERSION

### 3 INSTALLATION INSTRUCTIONS

#### Installing Solid Core CTs

1. Route CT wires through the conduit if not already done.
2. Trim the wire to the appropriate length to avoid coils of excess wiring.
3. Strip wiring to approximately .300 inches and connect to the appropriate terminals as described above.
4. With power turned off, disconnect each monitored conductor and slide on a CT, ensuring the CT is correctly oriented as noted above.
5. Reconnect the conductors.

**Failure to install CTs in the correct orientation and on the correct phase will lead to inaccurate meter readings.**



Figure 6: Leviton split core CTs

#### Installing Split Core CTs

1. Route CT secondary wires through conduit if not already done.
2. Trim the wire to the appropriate length to avoid coils of excess wiring.
3. Strip wiring to approximately .300 inches.
4. Connect the CT leads to the appropriate meter as described above.
5. With power to the conductors turned off, place one CT around each conductor, ensuring that the white dot is facing the line side.
6. Current and voltage inputs must be installed 'in phase' for accurate readings (e.g. CT1 on Line 1, CT2 on Line 2) Orientation is critical. Ensure that all CTs are properly oriented with the white label facing the line side of the circuit.

**Failure to install CTs in the correct orientation and on the correct phase will lead to inaccurate meter readings.**

WEB VERSION



3 INSTALLATION INSTRUCTIONS

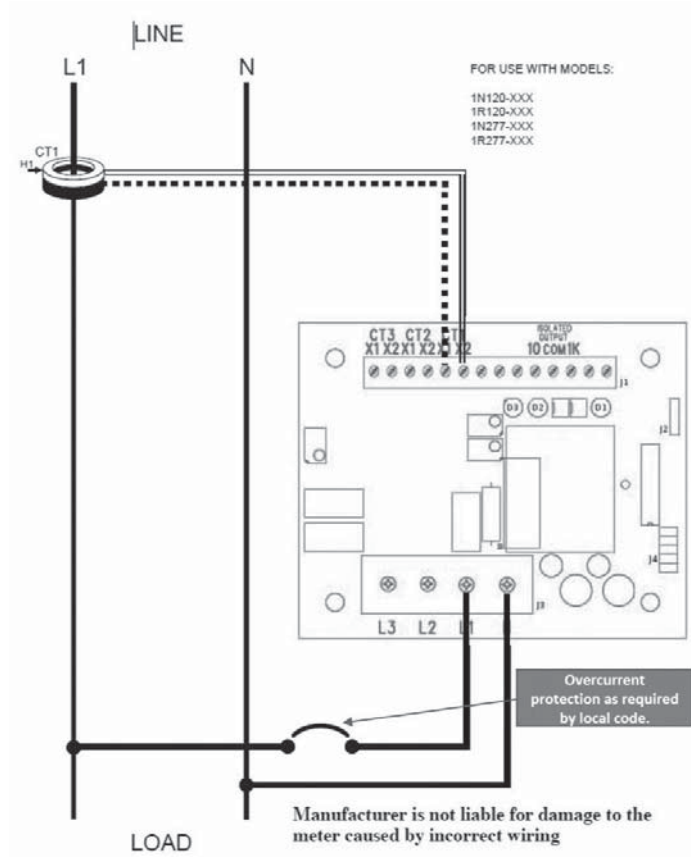

Figure 7: 1-phase, 2-wire Hookup Diagram

WEB VERSION

3 INSTALLATION INSTRUCTIONS

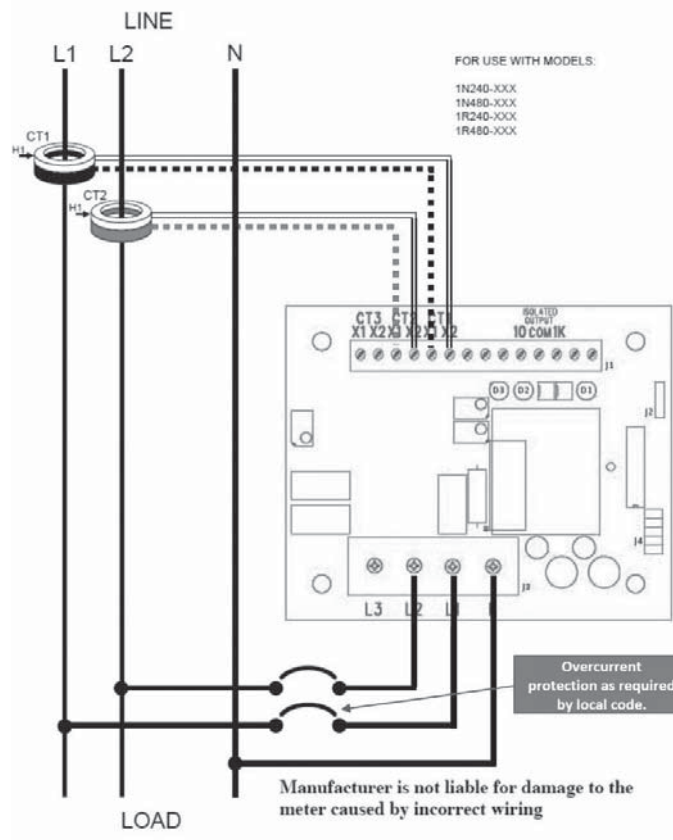

Figure 8: 1 or 2 phase, 3 wire Hookup Diagram

WEB VERSION

### 3 INSTALLATION INSTRUCTIONS

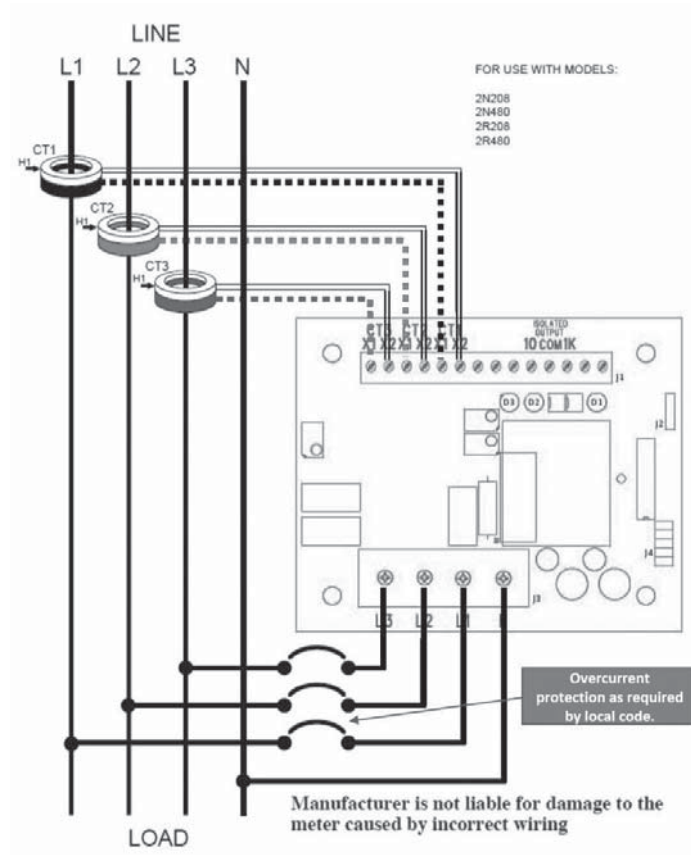

Figure 9: 3-phase, 4-wire WYE Hookup Diagram

### 3 INSTALLATION INSTRUCTIONS

#### 3.8 Testing the Installation

##### Testing Voltage

Voltage should be tested using an AC Voltmeter to verify that the voltage across voltage line terminals (L1, L2, and L3 to Neutral) is not in excess of the maximum rated voltage.

##### CT Reverse Phase Indicator

Series 1000 and Series 2000 meters have a red reverse phase indicator LED as described in section 2.3. **There must be a load drawing a minimum of 1 A connected to the meter in order for the reverse phase LED to function correctly.** If this LED is on (with sufficient load), power down the voltage supply and verify that CTs are installed correctly.

##### Load LEDs

The load LEDs are described in section 2.3. These LEDs should be illuminating at 50% duty cycle, appropriate to the load, when the meter is connected properly, and a constant load is applied. Without a proper load, the load LEDs could be on or off.

##### LCD Display

The Series 1000 and 2000 display is described in Section 2.4. From this description, it is possible to determine if the kWh and/or demand values displayed on the LCD are consistent with the applied load. A load must be applied for the kWh value to show significant changes.

#### 3.9 Securing the Enclosure

In accordance with safety requirements, enclosures must be secured using the provided key lock once installation is complete. The purpose of the lock is to prevent access to live parts that pose potential safety risks. To install the lock, slide through the provided holes on the clamp side of the enclosure and fasten securely.

#### 4 MAINTENANCE

Properly installed meters with sound connections and secure conduit fittings should not require user maintenance. If the meter is functioning abnormally, consult the FAQ / Troubleshooting guide. If the answer cannot be found there, contact Leviton technical support.

#### 5 TROUBLESHOOTING / FAQ

<u>Problem</u>	<u>Solution</u>
1. LCD Display not on	<ul style="list-style-type: none"><li>• Check to make sure all connections are wired</li><li>• Test the voltage being supplied to the meter using an AC voltmeter</li><li>• With power off, remove any additional in-line fuses and test the circuit with the appropriate test equipment</li></ul>
2. Load LED not flashing	<ul style="list-style-type: none"><li>• Verify CT connections and orientations</li><li>• Make sure there is sufficient load to draw a significant current</li><li>• Test the voltage being supplied to the meter using an AC voltmeter</li></ul>
3. Registered consumption low	<ul style="list-style-type: none"><li>• Check to make sure the reverse phase LED is not on</li><li>• Even if the reverse phase light is off, double-check CT orientations. One CT installed in the incorrect direction doesn't always illuminate the reverse phase LED</li><li>• Make sure that current and voltage connections are in phase</li><li>• Check power connections and fuses</li></ul>
4. Reverse phase LED illuminated	<ul style="list-style-type: none"><li>• Verify orientation and connection of CT wires</li><li>• Ensure that phasing is correct (CT1 on Line 1, CT2 on Line 2)</li><li>• Verify that a load drawing more than 1 Amp is connected to the meter</li></ul>