

User Manual
ENGLISH



5070



MEGOHMMETERS

Measure Up
WITH AEMC INSTRUMENTS



Copyright © Chauvin Arnoux®, Inc. d.b.a. AEMC® Instruments. All rights reserved.

No part of this documentation may be reproduced in any form or by any means (including electronic storage and retrieval or translation into any other language) without prior agreement and written consent from Chauvin Arnoux®, Inc., as governed by United States and International copyright laws.

This documentation is provided "as is," without warranty of any kind, express, implied, or otherwise. Chauvin Arnoux®, Inc. has made every reasonable effort to ensure that this documentation is accurate; but does not warrant the accuracy or completeness of the text, graphics, or other information contained in this documentation. Chauvin Arnoux®, Inc. shall not be liable for any damages, special, indirect, incidental, or inconsequential; including (but not limited to) physical, emotional or monetary damages due to lost revenues or lost profits that may result from the use of this documentation, whether or not the user of the documentation has been advised of the possibility of such damages.

Catalog #: 2130.30

Model #: 5070

Please fill in the appropriate date as indicated:

Date Received: _____

Date Calibration Due: _____



TABLE OF CONTENTS

1. INTRODUCTION	6
1.1 PRECAUTIONS FOR USE	7
1.2 RECEIVING YOUR SHIPMENT	7
1.3 ORDERING INFORMATION	8
1.3.1 Accessories and Replacement Parts	8
1.4 ACCESSORY INFORMATION	8
1.4.1 DataView® Software	8
2. PRODUCT FEATURES.....	9
2.1 DESCRIPTION	9
2.1.1 Control Features	10
2.2 DISPLAY FEATURES	12
3. SPECIAL FUNCTIONS	13
3.1 SET-UP FUNCTION	13
3.1.1 Default Configurations.....	13
3.1.2 Instrument Configuration Parameters	14
3.1.3 SET-UP Menu	21
3.2 MODE / PRINT BUTTON	22
3.2.1 Primary Function - MODE	22
3.2.2 Secondary Function - PRINT	26
3.3 DISPLAY / GRAPH BUTTON	26
3.3.1 Primary Function - DISPLAY	26
3.3.2 Secondary Function - GRAPH	39
3.4 ◀ / TEMP BUTTON	39
3.4.1 Primary Function - ◀	39
3.4.2 Secondary Function - TEMP	39
3.5 ▼ / SMOOTH BUTTON	41
3.5.1 Primary Function - ▼	41
3.5.2 Secondary Function - SMOOTH	41
3.6 ▲ / ALARM BUTTON	42
3.6.1 Primary Function - ▲	42
3.6.2 Secondary Function - ALARM.....	42
3.7 ▶ / ☀️ BUTTON	42
3.7.1 Primary Function - ▶	42
3.7.2 Secondary Function - ☀️	42
3.8 MEM / MR BUTTON	42
3.8.1 Primary Function - MEM (Save).....	42
3.8.2 Second Function - MR (Recall).....	44







3.9 CLEARING THE MEMORY	44
3.10 CALCULATION OF ΔT FROM STORED DATA.....	46
3.11 MAXIMUM OUTPUT VOLTAGE	47
3.12 LIST OF ERROR CODES.....	47
4. MEASUREMENT FUNCTIONS.....	48
4.1 AC/DC VOLTAGE	48
4.2 INSULATION MEASUREMENT	48
4.3 CAPACITANCE MEASUREMENT	51
4.4 RESIDUAL CURRENT MEASUREMENT	51
5. OPERATION	52
5.1 PERFORMING MEASUREMENTS	52
5.2 STEP FUNCTION MODE	53
5.3 OPERATION EXAMPLES.....	55
6. DATAVIEW® SOFTWARE	57
6.1 INSTALLING DATAVIEW	57
6.2 MEGOHMMETER CONTROL PANEL	59
7. SPECIFICATIONS.....	60
7.1 REFERENCE CONDITIONS	60
7.2 VOLTAGE.....	60
7.3 INSULATION RESISTANCE	60
7.4 POWER SUPPLY	65
7.5 ENVIRONMENTAL SPECIFICATIONS	65
7.6 MECHANICAL SPECIFICATIONS.....	66
7.7 SAFETY SPECIFICATIONS.....	66
7.8 VARIATIONS IN OPERATING RANGE	66
8. MAINTENANCE.....	67
8.1 RECHARGING THE BATTERY.....	67
8.2 FUSE REPLACEMENT.....	67
8.3 CLEANING.....	67
8.4 STORAGE.....	68
8.5 REPAIR AND CALIBRATION	68
8.6 TECHNICAL AND SALES ASSISTANCE	68
8.7 LIMITED WARRANTY.....	69
8.8 WARRANTY REPAIRS	69
APPENDIX A. UTILIZING THE GUARD TERMINAL.....	70
APPENDIX B. V DISTURBANCE/V OUTPUT FEATURE.....	72

1. INTRODUCTION

Thank you for purchasing a **Megohmmeter Model 5070**.

For best results from your instrument and for your safety, read the enclosed operating instructions carefully and comply with the precautions for use. These products must be used only by qualified and trained users.

Symbols

	Instrument is protected by double or reinforced insulation.
	CAUTION, risk of DANGER! The operator must refer to the user manual whenever this symbol appears.
	Risk of electric shock. The voltage at the parts marked with this symbol may be dangerous.
	The CE Mark guarantees conformity with European directives and with regulations covering EMC.
	The UKCA marking certifies that the product is compliant with the requirements that apply in the United Kingdom, specifically regarding Low-Voltage Safety, Electromagnetic Compatibility, and the Restriction of Hazardous Substances.
	The trash can with a line through it means that in the European Union, the product must undergo selective disposal for the recycling of electric and electronic material in compliance with Directive WEEE 2002/96/EC.

Definition of Measurement Categories (CAT)

CAT IV corresponds to measurements taken at the primary electrical supply (<1000V).
Example: primary overcurrent protection devices, ripple control units, and meters.

CAT III corresponds to measurements taken in building installations at the distribution level.

Example: distribution panel, circuit-breakers, machines, and fixed industrial devices.

CAT II corresponds to measurements taken on circuits directly connected to low-voltage installations.

Example: power supply to domestic electrical appliances and portable tools.

1.1 PRECAUTIONS FOR USE

These safety warnings are provided to ensure the safety of personnel and proper operation of the instrument.

- Do not attempt to perform any tests with these instruments until you have read the instruction manual.
- Safety is the responsibility of the operator!
- Tests are to be carried out only on non-energized circuits! Check for live circuits before making resistance measurements (safety check).
- High voltage is present, as is the sample connected to it. Anyone performing or assisting in testing must follow all safety precautions to prevent electrical shock to themselves and others.
- Use personal protective equipment where appropriate.
- When testing samples with a capacitive component, make sure they have been properly discharged and are safe to touch. Dielectric insulation samples should be short-circuited for at least five times the amount of time they were energized.
- Do not use the megohmmeter in areas where explosive or ignitable substances are present. The testing of electrical systems with a megohmmeter could create a spark and cause a hazardous situation.
- Only use the leads that are supplied with the megohmmeter. If they are defective or worn, replace before testing.
- This instrument can be used on installations rated for 1000 V, Category III.

1.2 RECEIVING YOUR SHIPMENT

- Match the contents with the ordering information.
- Notify your distributor of any missing items.
- If the equipment appears to be damaged, file a claim immediately with the carrier and notify your distributor at once.



NOTE: Fully charge the instrument before use.

1.3 ORDERING INFORMATION

Megohmmeter Model 5070..... Cat. #2130.30

Includes extra large tool bag, set of three 10 ft (5 kV) leads (red/black/blue with clips), one guard terminal jumper lead, USB cable type B, US 115 V power cord, rechargeable battery pack, and a USB stick with DataView® software and user manual.

1.3.1 Accessories and Replacement Parts

Cable – PC RS-232, DB9 F/F 6 ft Null Modem Cable (For meters without USB Port)	Cat. #2119.45
Cable – 5 ft USB A-B	Cat. #2140.46
Fuse – Set of 3, 0.1 A, 380 V, 5 x 20, .10 kA	Cat. #2119.84
Bag – Extra Large Classic Tool Bag	Cat. #2133.73
Inverter – 12 VDC to 120 VAC, 200 Watt for Vehicle use	Cat. #2135.43
Cable – Replacement 10 ft USB cable	Cat. #2136.80
Lead – Replacement set of 3, 10 ft (5 kV) Color-coded Safety with Clips (JUMPER LEAD NOT INCLUDED)	Cat. #2151.30
Lead – Replacement 1 ft Jumper Lead	Cat. #2151.31
Lead – Set of 3, 25 ft (5 kV) Safety with Clips	Cat. #2151.32
Battery – Rechargeable 9.6 V	Cat. #2960.21
US 115 V Power Cord	Cat. #5000.14

1.4 ACCESSORY INFORMATION

1.4.1 DataView® Software

Dataview® software makes it possible to:

- Retrieve data from memory and plot graphs of the changes in insulation as a function of the time over which the test voltage is applied, R(t).
- Print out protocols of personalized tests, depending on the user's needs.
- Create text files for use on spreadsheets.
- Set up and control the instrument entirely by the USB serial port.

Order Accessories and Replacement Parts Directly Online
Check our Storefront at www.aemc.com/store for availability

2. PRODUCT FEATURES

2.1 DESCRIPTION

The Model 5070 megohmmeter is a top-of-the-line measuring instrument, portable, in a rugged housing with a graphic display. It is capable of operating from internal battery or line power.

Main Functions:

- Automatic detection and measurement of voltage/frequency/input current.
- Quantitative and qualitative insulation measurement.
 - Measurement at 500/1000/2500/5000 VDC or other test voltage between 40 and 5100 VDC (adjustable voltage).
 - Measurement in voltage step mode (the applied voltage increases in steps).
 - Automatic calculation of DAR, PI, and DD (dielectric discharge index) quality ratios.
 - Automatic calculation of measurement result referred to a reference temperature.
- Automatic capacitance measurement.
- Automatic measurement of residual current.

This megohmmeter helps ensure the safety of electrical installations and equipment. The operation is controlled by a microprocessor for data acquisition, processing, display of measurements, and storage of results.

Advantages:

- Digital filtering of insulation measurements.
- Automatic voltage measurement.
- Automatic detection of external AC or DC voltages on the terminals, before or during insulation measurements, disabling or stopping the measurements when measurement accuracy is no longer guaranteed.
- Threshold programming to trigger audible alarms.
- Timer for measurement time checks.
- Fuse protection of the instrument with detection and display of defective fuses.
- Operator safety by automatic discharge of residual high voltage on the equipment tested.
- Automatic shutdown of the instrument to save battery power.
- Battery charge indication.
- Large backlit graphic display that is very easy to read.
- Memory (128 kB), real time clock, and serial interface.
- Control and programming of the instrument from a PC (using DataView software).

2.1.1 Control Features

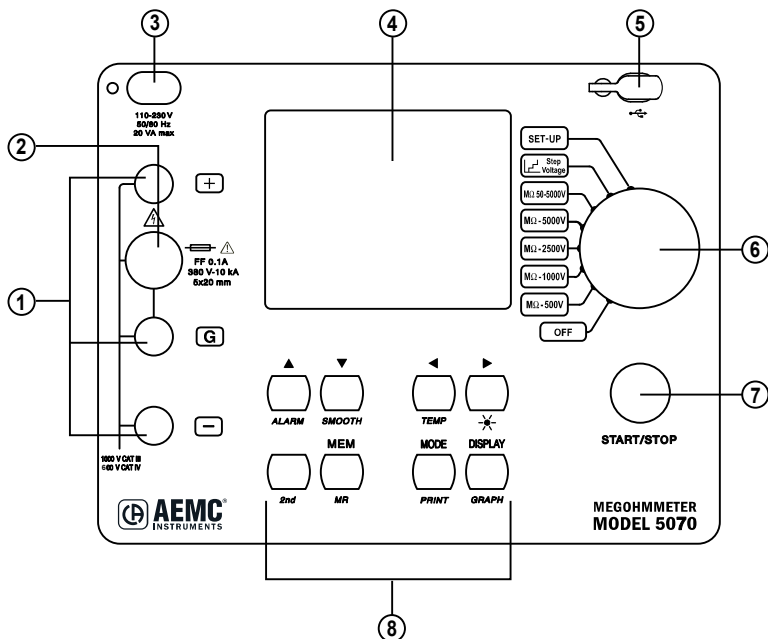

1. Safety terminals: +, G, and -.
2. Protective fuse access.
3. AC power plug (direct operation on AC and battery recharge).
4. Back-lit liquid crystal display.
5. Communication port: USB port (9600 baud).
6. Rotary selector switch with 8 positions:





Rotary selector switch positions	
Switch Position	Instrument
OFF	Instrument is off.
MΩ - 500 V	Insulation measurement (to 2 TΩ).
MΩ - 1000 V	Insulation measurement (to 4 TΩ).
MΩ - 2500 V	Insulation measurement (to 10 TΩ).
MΩ - 5000 V	Insulation measurement (to 10 TΩ).
MΩ 50 - 5000 V	Insulation measurement with selectable test voltage (from 40 to 5100 V: 10 V steps from 40 to 1000 V and 100 V steps from 1000 to 5000 V)
Step Voltage	Insulation measurement with voltage step function (up to 5 steps can be configured).
SET-UP	User programming of the megohmmeter configuration.

7. START/STOP button (starts and stops measurements).
8. Eight buttons with a primary and secondary function. The secondary functions are highlighted in yellow italics below each button:

Primary Button Functions	
Button	Primary Function
▲	Either selects a function or increases the parameter selected by the cursor. Holding the button increases the rate of change for the parameter.
▼	Either selects a function or decreases the parameter selected by the cursor. Holding the button increases the rate of change for the parameter.
◀	Selects a parameter to be modified to the left.
▶	Selects a parameter to be modified to the right.
MEM	Saves measured values.
MODE	Before starting a test, the mode function allows selection of run time, sample rate, DAR PI, and ratio times.
DISPLAY	Browses through the screens accessible before, during, and after the measurement
<i>2nd</i>	Selects the second function of each button.

Secondary Button Functions	
Button	Secondary Function
<i>ALARM</i>	Activates or deactivates the alarms programmed in SET-UP
<i>SMOOTH</i>	Starts or stops the smoothing of displayed values during testing.
<i>TEMP</i>	Activates temperature correction
☀	Turns the display backlight ON or OFF
<i>MR</i>	Recalls saved data
<i>PRINT</i>	Printing measurement data is completed through DataView software.
<i>GRAPH</i>	Browses through the screens accessible before, during, and after the measurement

2.2 DISPLAY FEATURES

REMOTE	Indicates that the instrument is controlled remotely via the USB interface. In this mode, the buttons and rotary switch are inactive, except for the OFF position.
COM	Flashes when data is transmitted to the serial interface. It is on continuously if there is a problem in transmission.
2nd	Indicates that the secondary function of a key will be used.
	Indicates that the “programmed time test” mode was selected before the measurement began.
DAR	Indicates that the “automatic calculation of Dielectric Absorption Ratio” mode was selected before the measurement was started.
PI	Indicates that the “automatic calculation of Polarization Index” mode was selected before the measurement was started.
DD	Indicates that the “automatic calculation of “Dielectric Discharge Index” mode was selected before the measurement was started.
SMOOTH	Smooths the insulation measurement readings on the display for better visibility.
ALARM	Indicates that the alarm is activated. An audible alarm will sound if the value measured is above the limit defined in the SET-UP mode.
	Indicates the remaining battery charge.
	Indicates that the generated voltage is dangerous, $V > 120 \text{ VDC}$.
	Indicates that external voltage is present - this symbol is activated when the Start button is pressed if $V > 25 \text{ VRMS}$.

3. SPECIAL FUNCTIONS

3.1 SET-UP FUNCTION

This function, located at the top rotary switch position (Blue "SET-UP" position), is used to change the configuration of the instrument.

3.1.1 Default Configurations

The default configurations are as follows:

SET-UP	
Instr.Nr. 9600004	SW Version 1.2
<input checked="" type="checkbox"/> Display contrast	80
Alarm Settings	
Adjustable Voltage 1	50V
Adjustable Voltage 2	100V
Adjustable Voltage 3	250V
Timed Run (h:m)	0:10
Sample Time (m:s)	0:10
DAR (s/s)	30/60
PI (m/m)	1.0/10
Set Step Function 1	
Set Step Function 2	
Set Step Function 3	
Temperature Unit	Celsius
Default probe temperature	23°C
Rc reference temperature	40°C
ΔT for R/2	10°C
Calculate ΔT from Memory	
Maximum Output Voltage	5100V
Set Default Parameter	
Clear Memory	
V Disturbance / V Output	3%
Buzzer	on
Power Down	off
Baud Rate	9600 / RS232
Units	Europe
Date (d.m.y)	04.02.2004
Time (h:m)	15:47

3.1.2 Instrument Configuration Parameters

DISPLAY CONTRAST

This function allows you to change the lightness and darkness of the display to best suit the environment.

Range
0 to 255*

*The display is not legible above 130.

To adjust the contrast, press the ► button to move the blinking cursor to the display contrast value. The default value is 80. Use the ▲ and ▼ buttons to lighten or darken the display. The higher the number the lighter the display will be. When finished, press the ◀ button to move the cursor back to the parameter selection position.

ALARM SETTINGS

This function allows you to select a low insulation resistance value that will cause an alarm symbol to appear on the display and will cause the buzzer to emit a continuous tone when the measured insulation resistance falls below this value.

Voltage	Range
500 V	30 kΩ to 2 TΩ
1000 V	100 kΩ to 4 TΩ
2500 V	300 kΩ to 10 TΩ
5000 V	
Adj. Voltage 1	10 kΩ to 10 TΩ
Adj. Voltage 2	
Adj. Voltage 3	

To adjust the alarm settings, press the ▼ button until the blinking cursor is to the left of alarm settings. To adjust the alarm value press the ► button. From the screen displayed, you can adjust low limit resistance values for 500 V, 1000 V, 2500 V, 5000 V, or the three adjustable voltage positions.

To change the low limit for any of these voltage positions, use the ▲ and ▼ buttons to select the voltage, then press the ► button to highlight the resistance value for that voltage. Next, use the ▲ and ▼ buttons to increase or decrease the value at the blinking cursor position.

Once the desired resistance value has been programmed, press the ◀ button to move the cursor again to the voltage selection part of the screen. You may now select the different voltage and adjust its value as just described.

To exit the alarm setting function, press the **DISPLAY** button. This will bring you back to the top of the SET-UP menu.

ADJUSTABLE VOLTAGE 1, 2, 3

This function defines a specific voltage that will be used for Insulation Resistance Measurement when the rotary switch is in the adjustable voltage position.

The values for this setting can be anywhere from 40 to 5100 volts adjustable in 10 or 100 volt increments.

Voltage	Range
Adj. Voltage 1	40 to 5100 V (in steps of 10 V from 40 to 1000 V) (in steps of 100 V from 1000 to 5100 V)
Adj. Voltage 2	
Adj. Voltage 3	

Three adjustable settings are possible.

Use the ▼ button to change the value for Adjustable Voltage 1, 2, or 3. To select the Adjustable Voltage parameter to program, press the ► button to highlight the voltage to be used for that selection, then use the ▲ and ▼ buttons to increment or decrement the value.

When the desired voltage is on screen, press the ◀ button to move the cursor back to the parameter selection position.

TIMED RUN (h : m)

This function lets you set a time from 1 minute to 49 hours and 59 minutes to run an insulation resistance test.

The Model 5070 will automatically end the test at the end of the timed run.

Range (Hours : Minutes)
00 to 49 : 01 to 59

To change the length of time that a test will run, press the ► button to move the blinking cursor to the hour in TIMED-RUN. Use the ▲ and ▼ buttons to increment or decrement the hours. Next, press the ► to select the minute value. Use the ▲ and ▼ buttons to increment or decrement the minutes.

When finished, press the ◀ button to move the cursor back to the parameter selection position.

SAMPLE TIME (m : s)

Data from a timed run test can be stored in the Model 5070 at an interval you select. This storage interval can be as fast as once every 10 seconds to as slow as once every 10 minutes.

Range (Minutes : Seconds)
00 to 10 : 10 to 59

DAR (s : s)

The Dielectric Absorption Ratio is a ratio of insulation resistance measured at two predetermined times. The reading at the first time mark is then divided into the reading at the second time mark to calculate the ratio. The typical times used for this test are 30 seconds and 60 seconds. These are the factory default settings. You can adjust the times here in the set up mode from 10 to 90 seconds for the first reading and from 15 to 180 seconds for the second reading, both in 5 second increments.



NOTE: The Model 5070 will not allow the time for the second reading to be set lower than the set time for the first reading.

Range (1st time mark : 2nd time mark)
10 to 90 : 15 to 180

PI (m : m)

The Polarization Index is a ratio of insulation resistance measured at two redetermined times. The reading at the first time mark is then divided into the reading at the second time mark to calculate the ratio. The typical times used for this test are 1 minute and 10 minutes. These are the factory default settings. The insulation materials used today require less time to determine this ratio. Therefore, you can adjust the times here in the set up mode to suit your needs from 0.5 minutes to 30 minutes for the first reading and from 1 minute to 90 minutes for the second reading.



NOTE: The Model 5070 will not allow the time for the second reading to be set lower than the set time for the first reading.

Range (1st time mark : 2nd time mark)
0.5 to 30 : 1 to 90

SET STEP FUNCTION 1, 2, 3

Step voltage testing can be a valuable tool in determining defective insulation or used to dry out cables that have been penetrated by moisture.

With this function, you can program three different profiles each containing up to 5 voltage steps and dwell times from 1 minute to 9 hours and 59 minutes per step.

Step Function	Default Value		Range	
	Voltage	Duration (h:m)	Voltage	Duration (h:m)
Step Function 1		h:m		h:m
Step 1	50 V	00:01		00 to 09 : 01 to 59
Step 2	100 V	00:01	40 to 5100 V (in 10 V, then 100 V steps)	00 to 09 : 01 to 59
Step 3	150 V	00:01		00 to 09 : 01 to 59
Step 4	200 V	00:01		00 to 09 : 01 to 59
Step 5	250 V	00:01		00 to 09 : 01 to 59
Sample Time		00:01 (m:s)		
Step Function 2		h:m		h:m
Step 1	100 V	00:01		00 to 09 : 01 to 59
Step 2	300 V	00:01	40 to 5100 V (in 10 V, then 100 V steps)	00 to 09 : 01 to 59
Step 3	500 V	00:01		00 to 09 : 01 to 59
Step 4	700 V	00:01		00 to 09 : 01 to 59
Step 5	900 V	00:01		00 to 09 : 01 to 59
Sample Time		00:01 (m:s)		
Step Function 3		h:m		h:m
Step 1	1000 V	00:01		00 to 09 : 01 to 59
Step 2	2000 V	00:01	40 to 5100 V (in 10 V, then 100 V steps)	00 to 09 : 01 to 59
Step 3	3000 V	00:01		00 to 09 : 01 to 59
Step 4	4000 V	00:01		00 to 09 : 01 to 59
Step 5	5000 V	00:01		00 to 09 : 01 to 59
Sample Time		00:01 (m:s)		

*The minimum sample time is related to the total duration of the test (Total Run Time). It is equal to: Sample Time (seconds) = (h+1)*5 where h= total run time in hours.

TEMPERATURE UNIT

This function toggles the display between Fahrenheit and Celsius scales for temperature display.

Range
°C or °F

DEFAULT PROBE TEMPERATURE

With this function, you can program a default value for the temperature of the device under test. This will be used when temperature correction is applied if no value is programmed right after the test is conducted.

Range
+5 to +167°F (-15 to +75°C)

Rc REFERENCE TEMPERATURE

Reference temperature to which the measurement result must be referred.

Range
+5 to +167°F (-15 to +75°C)

ΔT for R/2

Insulation resistance changes with temperature. The typical rule of thumb is that for every 10°C increase in temperature the leakage current doubles and the resistance halves. Some materials have a different rate of change. This feature lets you program the temperature change (ΔT) at which the resistance halves for the equipment you will be testing. This value will be used when correcting results to a reference temperature.

Range
+5 to +167°F -15 to +75°C

CALCULATE ΔT FROM MEMORY

The Model 5070 has the ability to calculate ΔT from three previously stored test results at different temperatures from one material in the event that no ΔT is selected for the present test.

MAXIMUM OUTPUT VOLTAGE

The Model 5070 provides the ability to limit the maximum test voltage to a value you specify from 40 to 5100 V. When programmed, the instrument will not generate a higher voltage to conduct the test even if the switch position indicates a higher voltage. For example, if you set the maximum voltage to 1250 V and place the rotary switch in the 5000 V position and start a test, the Model 5070 will only output 1250 V.

Range
40 to 5100 V

SET DEFAULT PARAMETER

This function allows you to reset all the user programmable functions back to the factory defaults.

CLEAR MEMORY

The clear memory function allows you to selectively erase individual tests or all tests from the internal memory of the instrument. A warning will appear first to ensure that you don't do this by accident.

V DISTURBANCE / V OUTPUT (see Appendix B)

This ratio defines the maximum allowable disturbance voltage depending on the selected measurement voltage. If the V Disturbance exceeds the value of the ratio, the instrument stops the test in process. If the voltage exceeding the ratio is present at the device under test before the test is started, a test will not be allowed to start. Three programmable values are: 3%, 10% and 20% of the measurement voltage. The default is 3%.

Example: If a test is to be performed at 1000 V and the V Disturbance / V Output is set at 10%, the presence of 100 volts ($1000\text{ V} * 10\% = 100$) before the test starts will inhibit the test.

Range
3%, 10%, or 20%

BUZZER

The Model 5070 is equipped with a buzzer that will emit an audible tone when a key is pressed, at regular intervals during a timed test, or continuously during an alarm trip. This function lets you toggle the buzzer on or off.

Range
ON or OFF

POWER DOWN

The Model 5070 has a power save feature that turns the unit's display off after 5 minutes of no activity, if a timed test is not in progress. This function lets you toggle this feature on or off.

Range
ON or OFF

BAUD RATE

This function lets you program in the communication speed between the Model 5070 and your computer. It must be set to 9600 for communication with DataView.

Press the down arrow ▼ button until the blinking cursor is to the left of Baud Rate. To adjust the baud rate, press the right arrow ► button to highlight the current setting. Next, press the up ▲ or down ▼ arrow buttons to select the desired baud rate. Your choices are 300, 600, 1200, 2400, 4800, 9600, or parallel. Press the right arrow ► button after you have selected the baud rate to complete the process.

Range
300 to 9600

UNITS

The Model 5070 can display the date in either US (m.d.y) or European (d.m.y) fashion. This choice can be toggled here.

Press the down arrow ▼ button until the blinking cursor is to the left of the units. To select the desired format, press the right arrow ► button to highlight the current setting. Next, press the up ▲ or down ▼ arrow buttons to select either USA or Europe. Press the right arrow ► button after you have selected the desired units to complete the process.

Range
Europe or USA

DATE

This function can set the day, month, and year values.

Press the down arrow ▼ button until the blinking cursor is to the left of Date.

To adjust the Date, press the right arrow ► button to highlight the current setting. The cursor will move to the first variable (day for European format or month for US format).

Next, press the up ▲ or down ▼ arrow buttons to select the desired value. Press the right arrow ► button to highlight the next date field (month for European format or day for US format).

Next, press the up ▲ or down ▼ arrow buttons to select the desired value. Press the right arrow ► button once more to highlight the last date field, which is year. Press the up ▲ or down ▼ arrow buttons to select the desired year. Finally, press the right arrow ► button after you have selected the date set up to complete the process.

Europe	USA
dd.mm.yyyy	mm.dd.yyyy

TIME (h:m)

Time can be set here. A 24-hour clock is used in the Model 5070. Therefore 3:30pm would be programmed in as 15:30.

Press the down arrow ▼ button until the blinking cursor is to the left of Time. To adjust the Time, press the right arrow ► button to highlight the current setting. The cursor will move to the hour selection. Next, press the up ▲ or down ▼ arrow buttons to select the desired hour from 0 to 24. Press the right arrow ► button again to highlight minutes. Next, press the up ▲ or down ▼ arrow buttons to select the desired minutes from 0 to 59. Finally, press the right arrow ► button after you have selected the time set up to complete the process.

3.1.3 SET-UP Menu

Turning the rotary switch to SET-UP gives you access to the menu of all programmable functions. Select the function to be modified using the ▲ and ▼ buttons. Move the blinking cursor to the value to be modified using the ◀ and ▶ buttons. Adjust the value at the blinking cursor using the ▲ and ▼ buttons. Move back to the select function position by pressing the ◀ and ▶ buttons until the blinking cursor is again to the left of the function.

Pressing the DISPLAY button while modifying a parameter will bring you back to the top of the SET-UP menu.

When you first enter the SET-UP mode a display similar to this will appear:

SET-UP	
Instr.Nr. 9600004	SW Version 1.2
▣ Display contrast	80
Alarm Settings	
Adjustable Voltage 1	50V
Adjustable Voltage 2	100V
Adjustable Voltage 3	250V
Timed Run (h:m)	0:10
Sample Time (m:s)	0:10
DAR (s/s)	30/60

- The top line on this screen indicates that you are in SET-UP mode.
- Line two indicates the Model 5070's Instrument Number and Software Version.
- The selection cursor will be blinking and positioned to the left of the "Display Contrast" parameter.

To adjust the "Display Contrast" parameter, press the ► button to move the blinking cursor to display contrast value. The default value is 80. Use the ▲ and ▼ buttons to lighten or darken the display. The higher the number the lighter the display will be. When finished, press the ◀ button to move the cursor back to the parameter selection position.

The arrow buttons can be used to modify any parameter.

3.2 MODE / PRINT BUTTON

3.2.1 Primary Function - MODE

The primary function of this button is used before the measurement takes place to define the measurement conditions.



NOTE: This button is inactive in the Step Voltage and SET-UP positions.

- Press the MODE button once to access the list of possible measurement modes. Select the mode using the ▲ ▼ and ◀ ▶ buttons.
- To validate the mode selected, press the MODE button again.

The measurement mode choices are as follows:

MANUAL STOP

This is the conventional quantitative insulation measurement mode.

The measurement is started by pressing **START/STOP** button and stopped by pressing the **START/STOP** button again.

In this mode, the user determines the duration of the test, which will be indicated by the elapsed time indicator.

MODE		
Total Run Time	---	
▶ Manual Stop		
Manual Stop + DD	Duration	Sample
	(h:m)	(m:s)
Timed Run	02:30	01:40
Timed Run + DD		
DAR (s/s)		30/60
PI (m/m)		1/10

MANUAL STOP + DD

The measurement is started by pressing **START/STOP** button and stopped by pressing **START/STOP** again.

The instrument calculates and displays the Dielectric Discharge (DD) ratio 1 minute after the end of the measurement. The time remaining during this minute is displayed.

MODE		
Total Run Time	---	
Manual Stop		
▶ Manual Stop + DD		
	Duration	Sample
	(h:m)	(m:s)
Timed Run	02:30	01:40
Timed Run + DD		
DAR (s/s)		30/60
PI (m/m)		1/10

TIMED RUN

This mode is used to perform a measurement for a duration defined in advance, with a predetermined number of measurement samples. The measurement is started by pressing the **START/STOP** button and stops automatically when the time specified by the user has passed.

This duration (Duration) and the time interval between samples (Sample) must be specified when the Timed Run mode is selected.

MODE		
Total Run Time	02:30:00	
Manual Stop		
Manual Stop + DD		
	Duration	Sample
	(h:m)	(m:s)
▶ Timed Run	02:30	01:40
Timed Run + DD		
DAR (s/s)		30/60
PI (m/m)		1/10

To set the Duration and Sample rate from the MODE screen proceed as follows:

- Use the ▲ or ▼ buttons to highlight Timed Run.
- Press the ► button to move the cursor to Duration, the hour value will be highlighted.
- Use the ▲ or ▼ buttons to select the desired hours from 0 to 49.
- Next, press the ► button to highlight minutes.
- Use the ▲ or ▼ buttons to select the desired minutes from 0 to 59.



The minimum selectable duration is 1 minute, and the maximum is 49 hours and 59 minutes.

- Press the ► button until the minute value in the sample rate is highlighted, then use the ▲ or ▼ buttons to adjust the minute value between 0 and 5.
- Next, press the ► button until the seconds value is highlighted.
- Use the ▲ or ▼ buttons to select the desired seconds from 1 to 59.



The shortest possible sample rate is 10 seconds, and the longest sample rate is 10:00 minutes.

When finished with Duration and Sample selections, press the ◀ or ▶ buttons again until the blinking cursor is at Timed Run.

You are now ready to begin a Timed Run Test for the selected Test Voltage.

- Press the Yellow START/STOP button to begin the test. The display will briefly show "OK" followed by the active test screen.
- When the measurement is started, the timer counts down showing the time remaining in the measurement.
- When the Remaining Time is zero, the measurement is stopped.

During the timed run test, the intermediate samples are automatically stored. They are used to plot a curve of insulation resistance vs time. This curve can be displayed after the measurement is completed by pressing the Yellow 2nd button and the GRAPH button, as long as no new measurement has been started.

The samples and the curve are automatically stored with the final value of the resistance, if it is stored.



During the measurement, if the position of the rotary switch is changed, or the START/STOP button is pressed, the measurement is stopped.

TIMED RUN + DD

This mode is identical to the Timed Run except that 1 minute after the end of the measurement, the instrument calculates and displays the Dielectric Discharge (DD). The measurement duration is the duration of timed run + 1 minute.

The insulation resistance vs time curve can be displayed after the measurement by pressing the Yellow 2nd button and the GRAPH button, as long as no new measurement has been started (see § 3.3.2 for a typical graph).

MODE		
Total Run Time	02:31:00	
Manual Stop		
Manual Stop + DD		
	Duration	Sample
	(h:m)	(m:s)
Timed Run	02:30	01:40
▶ Timed Run + DD		
DAR (s/s)	30/60	
PI (m/m)	1/10	

DAR

The DAR measurement is started by pressing the START/STOP button and stops automatically when the DAR ratio has been calculated, e.g. after 1 minute, the time taken to measure the second insulation resistance value needed for the calculation (the ratio times can be modified in the SET-UP mode). The default is 30/60 meaning the first reading will be taken in 30 seconds and the second reading will be taken in 60 seconds from the Start.

MODE		
Total Run Time	00:01:00	
Manual Stop		
Manual Stop + DD		
	Duration	Sample
	(h:m)	(m:s)
Timed Run	02:30	01:40
Timed Run + DD		
▶ DAR (s/s)	30/60	
PI (m/m)	1/10	

PI

The PI measurement is started by pressing the START/STOP button and stops automatically when the PI ratio has been calculated, e.g. after 10 minutes, the time taken to measure the second insulation resistance value needed for the calculation (the ratio times can be programmed in the SET-UP mode).

NOTE: In this mode, the DAR ratio will also be calculated automatically if the times needed to calculate it are less than the second time needed to calculate the PI ratio.

MODE		
Total Run Time	00:10:00	
Manual Stop		
Manual Stop + DD		
	Duration	Sample
	(h:m)	(m:s)
Timed Run	02:30	01:40
Timed Run + DD		
DAR (s/s)	30/60	
▶ PI (m/m)	1.0/10	

NOTE

1. What is the DD (Dielectric Discharge index)?

In the case of multilayer insulation, if one of the layers is defective but the resistance of all the others is high, neither the quantitative insulation measurement nor the calculation of the PI and DAR quality ratios will reveal the problem.

This makes it important to perform a dielectric discharge test so that the DD Ratio can be calculated. This test measures the dielectric absorption of heterogeneous or multilayer insulation and disregards parallel-surface leakage currents.

It involves applying a test voltage for long enough to electrically “charge” the insulation to be measured (typically, a voltage of 500 V is applied for 30 minutes).

At the end of the measurement, the instrument causes a rapid discharge, during which the capacitance of the insulation is measured; 1 minute later, the residual current circulating in the insulation is measured.

The DD Ratio is then calculated as follows:

$$\text{DD} = \frac{\text{current measured after 1 minute (mA)}}{[\text{test voltage (V)} \times \text{measured capacitance (F)}]}$$

The insulation quality rating, as a function of the value found, is as follows:

Value of DD	Quality of Insulation
DD > 7	Very Poor
DD between 7 and 4	Poor
DD between 4 and 2	Doubtful
DD < 2	Good

The dielectric discharge test is especially well-suited to insulation measurements on rotating machines, and in general, to insulation measurements on heterogeneous or multilayer insulations containing organic materials.

2. What are the DAR (Dielectric Absorption Ratio) and the PI (Polarization Indexes)?

It is beneficial to calculate insulation quality ratios, in addition to the quantitative insulation resistance value, because they can be used to eliminate the influence of certain parameters likely to invalidate the “absolute” insulation measurement.

The most important of these parameters are:

- Temperature and relative humidity with which insulation resistance varies to a quasi-exponential law.
- The leakage currents (capacitive charging current, dielectric absorption current) are created by the application of the test voltage. Even though they gradually fall off, they affect the measurement at the start for a length of time that depends on whether the insulation is in good condition or degraded.

These ratios complete the “absolute” insulation value and reliably reflect whether the insulation layers are in good or poor condition.

In addition, changes in these ratios over time can be observed and used for preventative maintenance (e.g. to monitor the aging of the insulation of a population of rotating machines).

The DAR and PI ratios are calculated as follows:

PI = R 10 min / R 1 min

(The 2 values to be noted during a 10 minute measurement are at the end of 1 minute and 10 minutes.)

DAR = R 1 min / R 30 sec

(The 2 values to be noted during a 1 minute measurement are at the end of 30 seconds and at the end of 1 minute.)

The times used for the PI calculation are 1 minute and 10 minutes. The DAR calculation uses 30 seconds and 60 seconds. The times for both calculations are considered standards and are programmed as defaults into the instrument. They can be modified in SET-UP mode to adapt to a possible change in a standard or to the needs of a specific application.

Interpretation of the results:

DAR	PI	Condition of Insulation
<1.25	<1	Poor or even dangerous
	<2	
<1.6	<4	Good
>1.6	>4	Excellent

3.2.2 Secondary Function - PRINT

This secondary function is unavailable through the interface. Printing measurement data is completed through DataView Software.

3.3 DISPLAY / GRAPH BUTTON

3.3.1 Primary Function - DISPLAY

The primary function of this button is used to browse through the various screens of information available before, during or after the measurement. The screens vary depending on the mode selected before the measurement is started.

This section, starting on the following page, shows typical screens that can be displayed for each test mode.

MANUAL STOP mode

BEFORE the measurement:

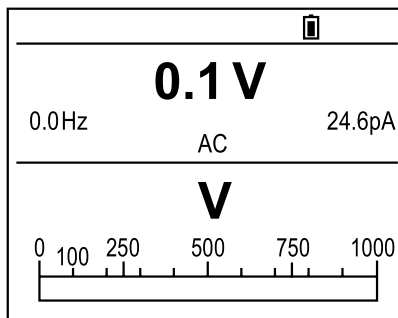
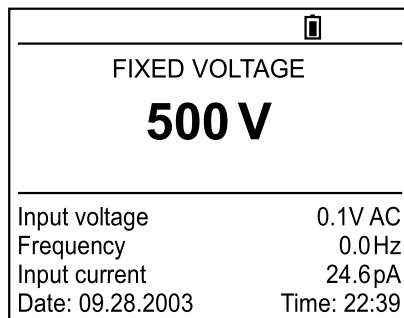

Information Displayed:

- Test type
- DC test voltage
- AC/DC input voltage
- Frequency
- Residual input current
- Date and Time

Information after pressing DISPLAY:

- AC/DC input voltage
- Frequency
- Residual input current
- Voltage bargraph

DURING the measurement:

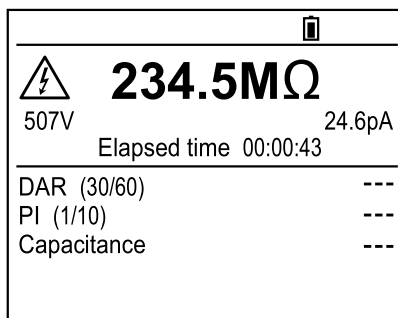
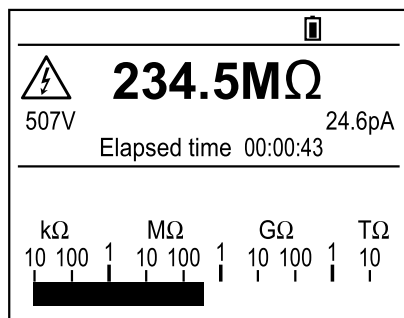

Information Displayed:

- Measured resistance
- DC test voltage
- Residual current
- Measurement duration
- Insulation resistance bargraph

Information after pressing DISPLAY:

- Measured resistance
- DC test voltage
- Residual current
- Measurement duration
- DAR, PI, Capacitance

AFTER the measurement:

234.5MΩ	
507V	24.6pA
Elapsed time 01:02:43	
DAR (30/60)	2.64
PI (1/10)	1.05
Capacitance	320nF

Information Displayed:
Measured resistance DC test voltage Leakage current Measurement duration DAR, PI, Capacitance values

FIXED VOLTAGE	
500 V	
Input voltage	0.1V AC
Frequency	0.0Hz
Input current	24.6pA
Date: 09.28.2003	Time: 22:49

After 1st Press on DISPLAY:
Test type and test voltage AC/DC input voltage Frequency Leakage current Date, time

0.1 V	
0.0Hz	24.6pA
AC	
V	
0 100 250 500 750 1000	

After 2nd Press on DISPLAY:
AC/DC input voltage Frequency Leakage current Voltage bargraph

MANUAL STOP + DD mode

BEFORE the measurement:

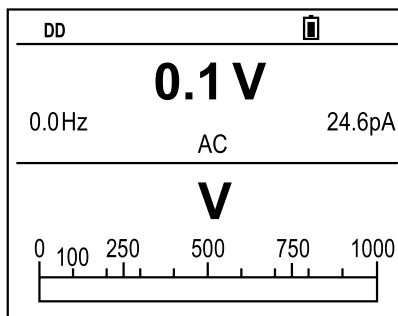
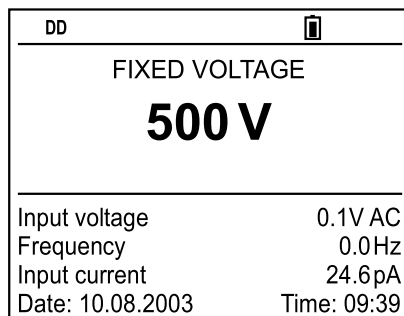

Information Displayed:

Test Type
DC test voltage
AC/DC input voltage
Frequency
Residual current
Date, time

Information after pressing DISPLAY:

AC/DC input voltage
Frequency
Leakage current
Voltage bargraph

DURING the measurement:

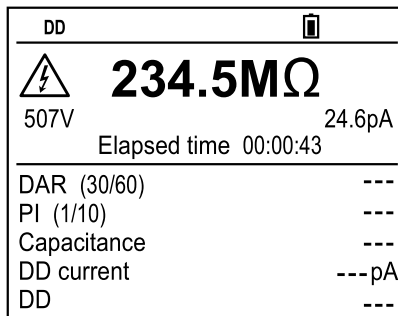
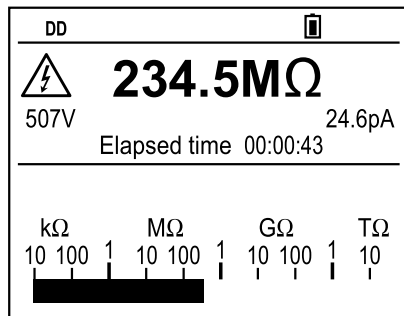

Information Displayed:

Measured resistance
DC test voltage
Leakage current
Measurement duration
Insulation resistance bargraph

Information after pressing DISPLAY:

Measured resistance
DC test voltage
Leakage current
Measurement duration
DAR, PI, Capacitance
Residual current (calculation of DD)
DD

AFTER the measurement:

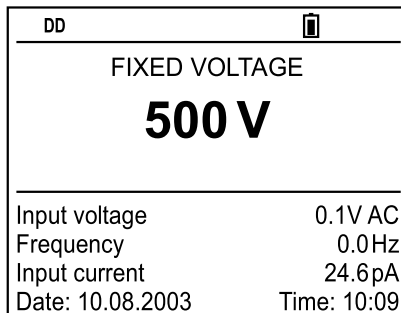
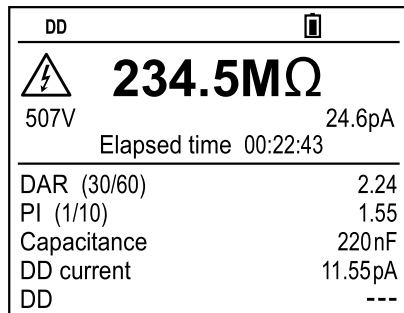

Information Displayed:

Measured resistance
DC test voltage
Leakage current
Measurement duration
DAR, PI, Capacitance values
Residual current (calculation of DD)
DD

After 1st Press on DISPLAY:

Test Type
DC test voltage
AC/DC input voltage
Frequency
Leakage current
Date, time

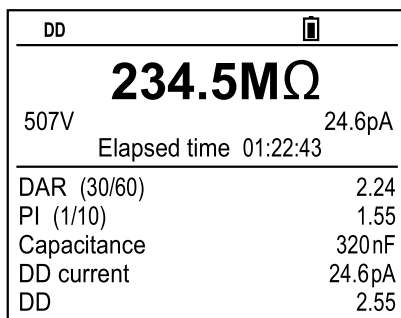
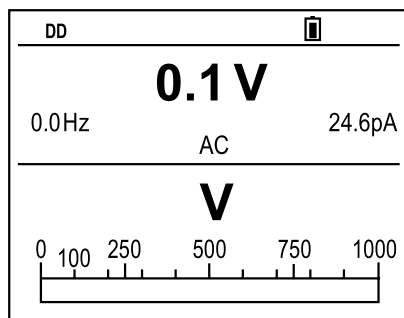

After 2nd Press on DISPLAY:

AC/DC input voltage
Frequency
Leakage current
Voltage bargraph

After 1 Minute:

Measured resistance
DC test voltage
Leakage current
Total test time
DAR, PI, Capacitance
DD test current
DD

TIMED RUN mode

BEFORE the measurement:

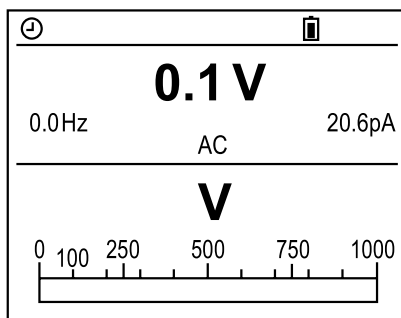
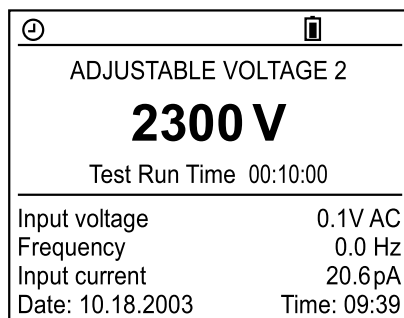

Information Displayed:

- Test type
- DC test voltage
- Programmed duration of the test
- AC/DC input voltage
- Frequency
- Residual current
- Date, time

Information after pressing DISPLAY:

- AC/DC input voltage
- Frequency
- Residual current
- Voltage bargraph

DURING the measurement:

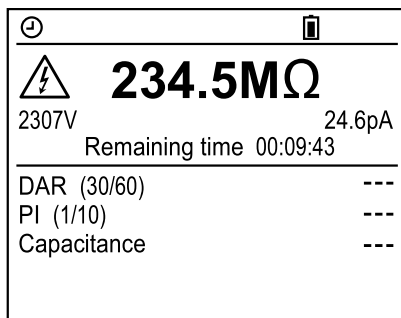
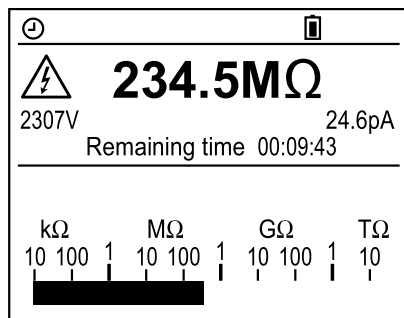

Information Displayed:

- Measured resistance
- DC test voltage
- Leakage current
- Remaining measurement time
- Insulation resistance bargraph

Information after pressing DISPLAY:

- Measured resistance
- DC test voltage
- Leakage current
- Remaining measurement time
- DAR, PI, Capacitance

AFTER the measurement:

234.5MΩ	
2307V	20.6pA
Elapsed time 00:10:00	
DAR (30/60)	2.64
PI (1/10)	1.05
Capacitance	320nF

Information Displayed:
Measured resistance DC test voltage Leakage current Measurement duration DAR, PI, Capacitance values

ADJUSTABLE VOLTAGE 2	
2300 V	
Test Run Time 00:10:00	
Input voltage	0.1V AC
Frequency	0.0 Hz
Input current	20.6pA
Date: 10.18.2003	Time: 09:49

After 1st Press on DISPLAY:
Test type DC test voltage Programmed duration of the test AC/DC input voltage Frequency Leakage current Date, time

0.1 V	
0.0Hz	20.6pA
AC	
V	

After 2nd Press on DISPLAY:
AC/DC input voltage Frequency Leakage current Voltage bargraph

TIMED RUN + DD mode

BEFORE the measurement:

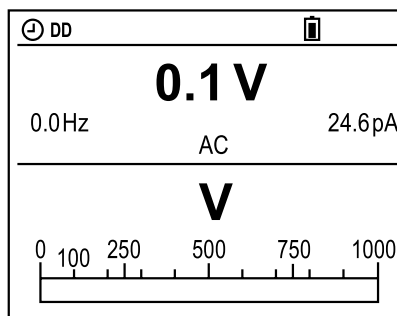
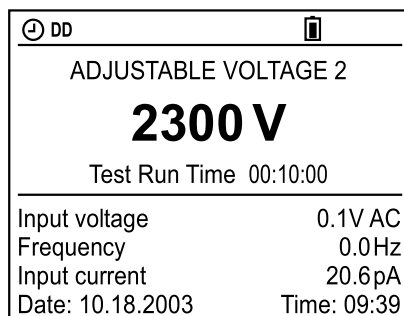

Information Displayed:

- Test type and DC test voltage
- Programmed duration of the test
- AC/DC input voltage
- Frequency
- Residual current
- Date, time

Information after pressing DISPLAY:

- AC/DC input voltage
- Frequency
- Residual current
- Voltage bargraph

DURING the measurement:

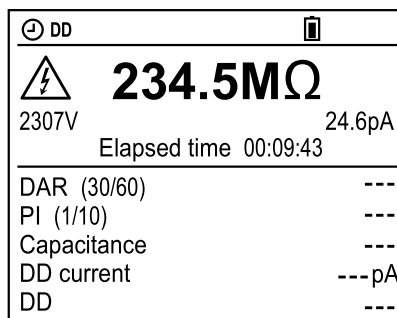
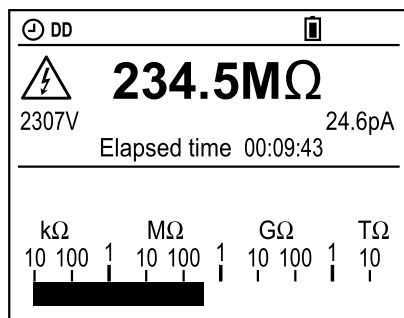

Information Displayed:

- Measured resistance
- DC test voltage
- Leakage current
- Remaining measurement time
- Insulation resistance bargraph

Information after pressing DISPLAY:

- Measured resistance
- DC test voltage
- Leakage current
- Remaining measurement time
- DAR, PI, Capacitance
- Residual current (calculation of DD)
- DD

AFTER the measurement:

⏪ DD	🗑
234.5MΩ	
2307V	24.6pA
Elapsed time 00:10:00	
DAR (30/60)	2.24
PI (1/10)	1.55
Capacitance	320nF
DD current	11.55pA
DD	---

⏪ DD	🗑
ADJUSTABLE VOLTAGE 2	
2300 V	
Input voltage	0.1V AC
Frequency	0.0 Hz
Input current	24.6pA
Date: 10.18.2003	Time: 10:05

Information Displayed:
Measured resistance
DC test voltage
Leakage current
Measurement duration
DAR, PI, Capacitance
Residual current (calculation of DD)
DD

After 1st Press on DISPLAY:
Test type
DC test voltage
AC/DC input voltage
Frequency
Leakage current
Date, time

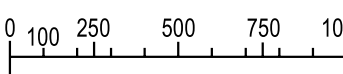
⏪ DD	🗑
0.1 V	
0.0Hz	24.6pA
AC	
V	
	

⏪ DD	🗑
234.5MΩ	
2307V	24.6pA
Elapsed time 00:10:00	
DAR (30/60)	2.24
PI (1/10)	1.55
Capacitance	320nF
DD current	11.55pA
DD	2.55

After 2nd Press on Display:
AC/DC input voltage
Frequency
Leakage current
Voltage bargraph

After 1 Minute:
Measured resistance
DC test voltage
Leakage current
Total test time
DAR, PI, Capacitance
DD test current
DD

DAR mode

BEFORE the measurement:

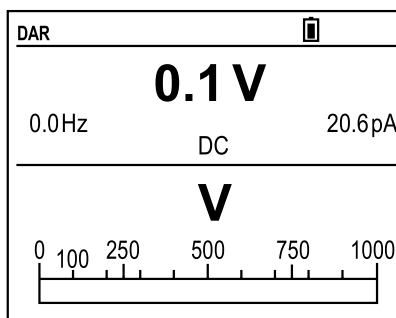
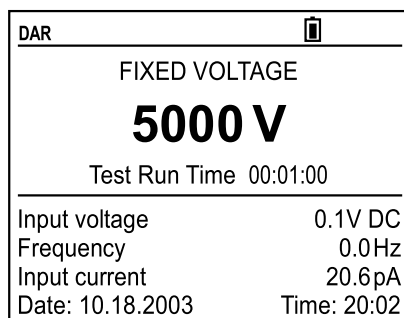

Information Displayed:

- Test type
- DC test voltage
- Programmed duration of the test
- AC/DC input voltage
- Frequency
- Residual current
- Date and Time

Information after pressing DISPLAY:

- AC/DC input voltage
- Frequency
- Residual current
- Voltage bargraph

DURING the measurement:

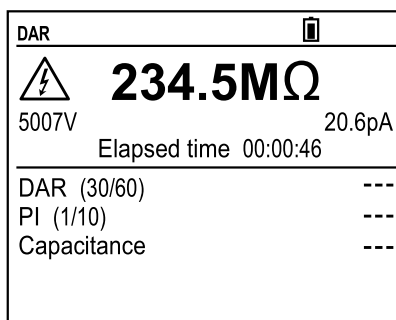
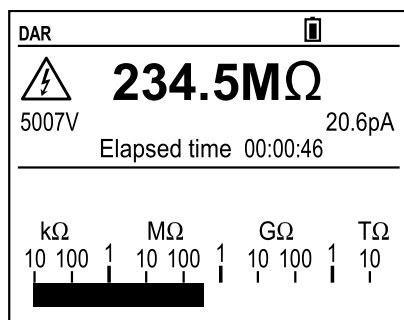

Information Displayed:

- Measured resistance
- DC test voltage
- Leakage current
- Remaining measurement time
- Insulation bargraph

Information after pressing DISPLAY:

- Measured resistance
- DC test voltage
- Leakage current
- Remaining measurement time
- DAR, PI, Capacitance in process

AFTER the measurement:

DAR	
234.5MΩ	
5007V	20.6pA
Elapsed time 00:01:00	
DAR (30/60)	2.64
PI (1/10)	---
Capacitance	320nF

Information Displayed:
<p>Measured resistance DC test voltage Leakage current Measurement duration DAR, PI*, Capacitance</p>

DAR	
FIXED VOLTAGE	
5000 V	
Test Run Time 00:01:00	
Input voltage	0.1V DC
Frequency	0.0 Hz
Input current	20.6pA
Date: 10.18.2003	Time: 20:03

After 1st Press on DISPLAY:
<p>Test type DC test voltage Programmed duration of the test AC/DC input voltage Frequency Leakage current Date and time</p>

DAR	
0.1 V	
0.0Hz	20.6pA
DC	
V	

After 2nd Press on Display:
<p>AC/DC input voltage Frequency Leakage current Voltage bargraph</p>

**NOTE: Because the test will stop after the DAR calculation, PI will not be calculated if the time values for this test are longer than those set for DAR.*

PI mode

BEFORE the measurement:

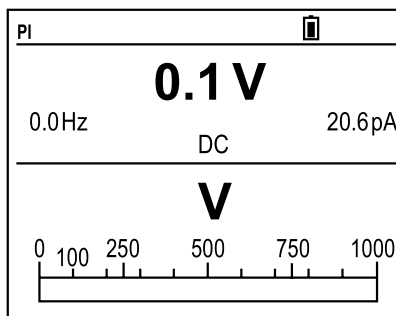
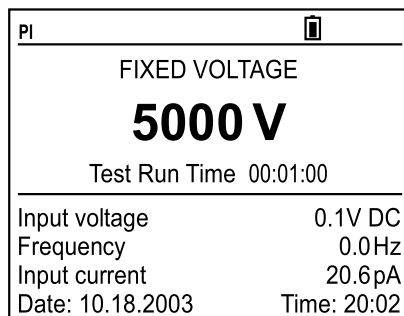

Information Displayed:

Test type
DC test voltage
Programmed duration of the test
AC/DC input voltage
Frequency
Residual current
Date and Time

Information after pressing DISPLAY:

AC/DC input voltage
Frequency
Residual current
Voltage bargraph

DURING the measurement:

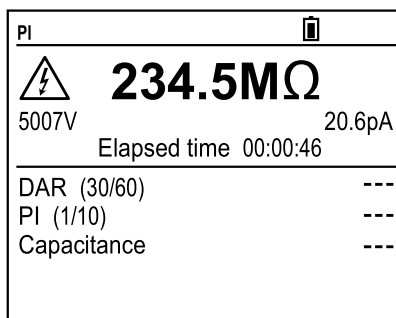
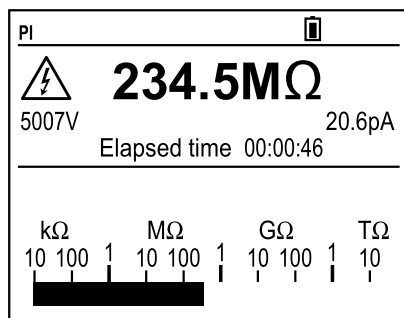

Information Displayed:

Measured resistance
DC test voltage
Leakage current
Remaining measurement time
Insulation bargraph

Information after pressing DISPLAY:

Measured resistance
DC test voltage
Leakage current
Remaining measurement time
DAR, PI, Capacitance in process

AFTER the measurement:

PI	🗑️
234.5MΩ	
5007V	20.6pA
Elapsed time 00:10:00	
DAR (30/60)	---
PI (1/10)	2.74
Capacitance	320nF

Information Displayed:
Measured resistance DC test voltage Leakage current Measurement duration DAR, PI*, Capacitance

PI	🗑️
FIXED VOLTAGE	
5000 V	
Test Run Time 00:10:00	
Input voltage	0.1V DC
Frequency	0.0 Hz
Input current	20.6pA
Date: 10.18.2003	Time: 10:03

After 1st Press on DISPLAY:
Test type DC test voltage Programmed duration of the test AC/DC input voltage Frequency Leakage current Date and time

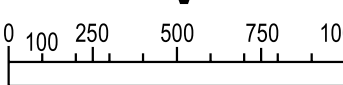
PI	🗑️
0.1 V	
0.0Hz	20.6pA
DC	
V	
0 100 250 500 750 1000 	

After 2nd Press on DISPLAY:
AC/DC input voltage Frequency Leakage current Voltage bargraph

3.3.2 Secondary Function - GRAPH

At the end of a programmed Time Test (Timed Run or Timed Run + DD), pressing the **2nd + GRAPH** buttons will bring up a display of the Insulation Resistance versus time curve as shown below.

The resolution of this presentation is dependent on the sample time selected before the test or during set-up.

The ◀ and ▶ buttons can be used to move the vertical cursor along the time axis to display the insulation resistance and elapsed test time at the cursor position.

Pressing the **DISPLAY** button returns to the Digital Presentation of Results.

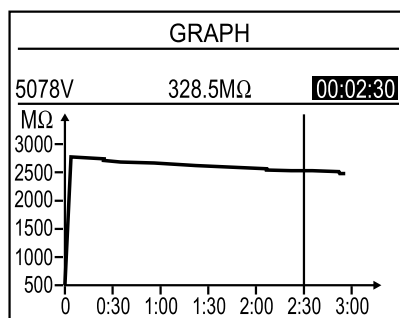

3.4 ◀ / TEMP BUTTON

3.4.1 Primary Function - ◀

Selects the parameter to be modified to the left or moves the cursor on a graph screen to the left.

3.4.2 Secondary Function - TEMP

At the completion of a test, press the **2nd + TEMP** buttons to show the Temperature Correction display.

This function provides the ability to display and store temperature corrected Insulation Resistance readings. Therefore, tests compared to historical data can all be referenced to a common temperature for better qualitative analysis.

NOTE:

- The TEMP function can be activated only after a measurement has been completed either before or after it is stored.
- If the result of your measurement is outside of the instrument's range (the display shows the < or > symbol next to the reading), the Temperature Correction function cannot be applied.
- Temperature correction is not available on Step Voltage tests.

Procedure:

- You have made a measurement and not yet stored it. Check that the result is within the Instrument's measurement range.
- Enter the TEMP mode by pressing the **2nd + TEMP** buttons.
- Enter the estimated temperature (Probe Temperature) at which you made the measurement (by default, the instrument offers the value set in SET-UP).
- With the blinking cursor next to "Probe Temperature", press the ► button to activate probe temperature. Use the ▲ or ▼ buttons to increase or decrease the temperature.
- Press the ◀ or ▶ buttons to move the cursor back to the selection position.
- Next, make sure "Resistance Correction" is turned "on" to perform the calculation (the default value in SET-UP is "off").
- Press the ▼ button to select "Resistance Correction." Press the ► button to highlight "off", then press the ▲ or ▼ buttons to select "on".
- The calculation is performed immediately and the result is displayed as Rc along with the Reference Temperature.
- This indicates what the measurement result would have been at the reference temperature.
- The Reference Temperature (Rc Reference Temperature) and the coefficient ΔT indicated and used for the calculation are those defined in SET-UP.

Note: To store this calculation, press the **2nd + TEMP** buttons again (OK is then displayed) before storing everything.

TEMPERATURE	
▶ Probe Temperature	23.7°C
Resistance Correction	on
RcReference Temperature	28.5°C
ΔT for R/2	23.0°C
R measured	273.7M Ω
Rc at 28.5°C	328.5M Ω

TEMPERATURE	
Probe Temperature	23.7°C
▶ Resistance Correction	on
RcReference Temperature	28.5°C
ΔT for R/2	23.0°C
R measured	273.7M Ω
Rc at 28.5°C	328.5M Ω

NOTE:

- During the procedure, pressing the **DISPLAY** button or turning the rotary switch cancels the calculation in progress.
- If the coefficient ΔT used for the calculation is not known, the instrument can calculate it in advance using at least 3 stored measurements made at different temperatures (see § 3.10).

The calculation is performed as follows:

The insulation resistance varies with the measurement temperature. This dependence can be approximated by the expression:

$$R_c = K_T * R_T$$

Where:

R_c: Corrected Insulation Resistance to the reference temperature
R_c
Reference Temperature

R_T: Measured Insulation Resistance at Probe Temperature

K_T: Coefficient T defined as follows:

$$K_T = (1/2) (R_c \text{ Temperature Reference} - T) / \Delta T.$$

T: Probe Temperature.

ΔT : Temperature change for which the Insulation Resistance is divided by 2.

R_c Temperature Reference: Temperature to which the Insulation Resistance measurement is adjusted.

Example: A motor winding is tested at 1000 V in a 68°F environment. At the end of the timed test, the Insulation Resistance Value is 991 MΩ. All the historical data is at 104°F. The corrected Insulation Resistance value corrected to 104°F for this motor is calculated by the Model 5070 to be 284.4 MΩ using the formula above when temperature correction is activated.

3.5 ▼ / SMOOTH BUTTON

3.5.1 Primary Function - ▼

Decreases the value of the flashing parameter displayed or selects the next parameter down.

3.5.2 Secondary Function - SMOOTH

The SMOOTH function (activated by pressing the **2nd + SMOOTH** buttons) activates/deactivates an insulation measurement digital filter.

Only the display is affected (which is smoothed), not the measurements. This function is useful if the insulation values displayed are very unstable.

The filter is calculated as follows:

$$R_{SMOOTH} = R_{SMOOTH} + (R - R_{SMOOTH}) / N$$

Since N is set to 20, the time constant of this filter is approximately 20 seconds. Therefore, displayed results are presented more smoothly.

3.6 ▲ / ALARM BUTTON

3.6.1 Primary Function - ▲

Increases the value of the flashing parameter displayed or selects the next parameter up.

3.6.2 Secondary Function - ALARM

To activate the ALARM function before or during a test, press the **2nd + ALARM** buttons. The word **ALARM** will appear at the top right side of the display.

If the insulation resistance drops below the set value at any time during the test, the **ALARM** symbol will flash and the buzzer will be continuously on (if activated), as long as the alarm condition exists.

The alarm function can be deactivated at any time by pressing the **2nd + ALARM** buttons again.

3.7 ► / ☀️ BUTTON

3.7.1 Primary Function - ►

Selects the parameter to be modified to the right or moves the cursor on a graph screen to the right.

3.7.2 Secondary Function - ☀️

- To activate the display backlight, press the **2nd + ☀️** buttons.
- To deactivate, press the **2nd + ☀️** buttons again.

3.8 MEM / MR BUTTON

3.8.1 Primary Function - MEM (Save)

The instrument can record the results and store them along with addresses to identify the corresponding object and test.

The object, indicated as Obj on the display, can represent a single piece of equipment, a department, or an entire facility. The Obj can hold up to 99 tests that represent the different insulation resistance measurements performed on the Obj.

Example: If the Obj is a 3-phase motor, then each test number will represent a specific insulation resistance measurement.

- e.g. - Test 1 = Phase A to housing
Test 2 = Phase B to housing
Test 3 = Phase C to housing
and so on.

When the MEM button is pressed, the following screen is displayed:

- The flashing cursor identifies the first free Obj : Test location.

Here - **02 : 59** (the Obj. number is that of the last measurement stored, but the Test number is incremented by 1).

- It is always possible to modify Obj. Test using the ▲ , ▼ , ◀ , ▶ buttons.
- If a new Obj is selected, the test number is set to 01 automatically.
- If you select a memory address that is already occupied, the screen to the right is displayed and prompts you to confirm or cancel deletion of the content of that address.
- To confirm overwriting, press the ► button.
- To cancel, press the ▼ button to highlight **CANCEL**. Then, press the ► button to confirm.

Store		MEMORY		
Obj.	Test	Date	Time	Fct.
02	59	12.07.2003	22:39	3800V ⊕
02	58	11.29.2003	15:47	50V ⊕
02	03	11.24.2003	15:04	2150V
02	02	10.29.2003	21:45	975V
02	01	09.30.2003	02:43	5000V ⊕
01	02	09.02.2003	15:07	⊕

Store		MEMORY		
!WARNING!				
Old data set will be overwritten !				
► O.K.				
CANCEL				

When the MEM key is pressed again, the measurement results are recorded at the selected memory address (whether occupied or not).

All information from the measurement will be stored at a single location in memory: date, time, test mode and voltage, insulation resistance, capacitance, residual current, and, possibly, DAR, PI, DD (if available), temperature corrected resistance and the R(t) graph.



WARNING: If a button other than MEM is pressed or if the selector switch is moved before pressing MEM a second time, the instrument exits from MEM mode without saving the results.

Memory Capacity

- Total memory space: 128 kB
- Data management: 8 kB
- Free memory space: 120 kB

An insulation measurement requires 80 bytes. Therefore, approximately 1500 insulation measurements can be stored.

Free Memory Space

This function is automatically activated when a result is saved.

Press the **MEM** button once to bring up the first available Obj and Test storage location. A bargraph is displayed corresponding to the available memory location.

- If the entire memory is free, all of the bargraph segments appear.
- If the entire memory is full, the arrow to the left of the bargraph flashes.
- As soon as the storage is complete, the bargraph disappears.

Each segment of the bargraph equals approximately 50 recordings.

3.8.2 Second Function - MR (Recall)

The MR function allows you to recall any of the stored data from memory, regardless of the position of the rotary selector switch, except OFF or SETUP.

When the MR button is activated, the following screen is displayed:

- The flashing cursor identifies the last occupied Obj and Test number. In this case, it is 47 : 99
- Use the ▲ , ▼ , ◀ , ▶ buttons to select the desired Obj and Test number.
- After selecting the Obj and Test, press the ▶ button to access the first item of information relative to this measurement.
- To access more data, press DISPLAY repeatedly, or press GRAPH if the mode selected before the start of the measurement allows.

Recall		MEMORY		
Obj.	Test	Date	Time	Fct.
▶ 47	99	12.15.2003	07:04	625V
13	59	12.07.2003	22:39	3800V ⊕
13	58	11.29.2003	15:47	50V ⊕
02	03	11.24.2003	15:04	2150V
02	02	10.29.2003	21:45	975V
02	01	09.30.2003	02:43	5000V ⊕
01	02	09.02.2003	15:07	⏏ ⊕

To exit the MR function, press the **MR** button once again or turn the selector switch to another position.

3.9 CLEARING THE MEMORY

In SET-UP, select "Clear memory" by using the ▼ button to highlight this function. Press the ▶ button to enter this mode.

To erase the content of one or more specific OBJ : TEST numbers:

- Select "Select Data Sets to Clear" by pressing the ▶ button.
- Then, select each memory to be erased using the ▲ , ▼ buttons to choose it and the ▶ button to select it. The ◀ button will deselect it.

- Validate by pressing **DISPLAY**. The operation is confirmed by pressing the ► button with the OK option highlighted, or cancelled by pressing the ► button with the CANCEL option highlighted.

SET-UP	
Instr.Nr. 9600004	SW Version 1.2
Rc reference temperature	40°C
ΔT for R/2	10°C
Calculate ΔT from Memory	
Maximum Output Voltage	5100V
Set Default Parameter	
<input checked="" type="checkbox"/> Clear Memory	
V Disturbance / V Output	30%
Buzzer	on

SET-UP	
Clear memory:	
<input checked="" type="checkbox"/> Select Data Sets to Clear	
Clear All	

SET-UP				
Clear memory:				
Obj.	Test	Date	Time	Fct.
47	99	15.12.2003	07:04	625V
13	59	07.12.2003	22:39	3800V ⊕
▶ 13	58	29.11.2003	15:47	50V ⊕
02	03	24.11.2003	15:04	2150V

SET-UP	
!WARNING!	
All selected data sets will be cleared!	
<input checked="" type="checkbox"/> O.K.	
CANCEL	

To erase the entire memory:

- Select "Clear All" by pressing the ▼ button to highlight it and the ► button to choose it.

SET-UP	
Clear memory:	
Select Data Sets to Clear	
<input checked="" type="checkbox"/> Clear All	

SET-UP	
!WARNING!	
All data sets will be cleared!	
<input checked="" type="checkbox"/> O.K.	
CANCEL	

- The operation is confirmed or cancelled by pressing the ► button when the appropriate choice is highlighted as described above.

3.10 CALCULATION OF ΔT FROM STORED DATA

The coefficient ΔT is used to calculate the insulation resistance at a temperature other than the measurement temperature. It is the temperature difference at which the insulation resistance concerned is divided by 2.

This coefficient is variable and depends on the type of insulation. When it is not known, the instrument can calculate it from three or more stored measurements.



NOTE: These 3 measurements must have been made on identical insulation but at 3 different temperatures, and the temperatures must have been recorded using the 2nd + TEMP buttons at the same time as the measurements, without applying the correction (Resistance Correction OFF).

- In the SET-UP mode, select “Calculate ΔT from Memory” and press the ► button. The display shows all values recorded with a temperature.
- Select at least 3 measurements using the ▲ , ▼ , ◀ , and ▶ buttons.
- ΔT is calculated and recorded automatically once 3 stored measurements have been selected, and will be updated if more measurements are selected.
- The larger the number of measurements, the more accurate the calculation of ΔT .



NOTE: This calculation is available only for resistance values < 200 G Ω .

SET-UP	
Instr.Nr. 9600004	SW Version 1.2
► Calculate ΔT from Memory	
Maximum Output Voltage	5100V
Set Default Parameter	
Clear Memory	
V Disturbance / V Output	10%
Buzzer	on
Power Down	on
Baud Rate	9600 / RS232

SET-UP			
ΔT Calculation for R/2			23.7°C
Obj. Test	Res.	Volt.	Temp.
47 99	228.5M Ω	5078V	23°C
13 59	208.5M Ω	5078V	30°C
13 58	178.5M Ω	5078V	37°C
► 02 03	328.5M Ω	5078V	23°C
02 02	328.5M Ω	5078V	23°C
02 01	328.5M Ω	5078V	23°C

3.11 MAXIMUM OUTPUT VOLTAGE

In the SET-UP menu, select “Maximum Output Voltage” pressing the ▼ button to highlight it and the ► button to choose it.

SET-UP	
Instr.Nr. 9600004	SW Version 1.2
Calculate ΔT from Memory	
► Maximum Output Voltage	5100V
Set Default Parameter	
Clear Memory	
V Disturbance / V Output	10%
Buzzer	on
Power Down	on
Baud Rate	9600 / RS232

Adjust the maximum output voltage using the ▲ , ▼ buttons.

This function prohibits the use of test voltages higher than the selected maximum output voltage for the insulation measurement.

The instrument can then be used by less experienced personnel for specific applications where it is important not to exceed a maximum test voltage.

Example: if the maximum output voltage is set to 750 V and the measurement is made in the 5000 V switch position, only 750 V will be generated.

3.12 LIST OF ERROR CODES

If an inconsistency is detected when the instrument is started up or in operation, the display unit indicates an error code. The format of this error code is a 1 or 2 digit number. This number identifies the problem and the action to be taken.

Here are some examples of possible errors:



Codes from 0 to 9 identify fatal errors in the hardware. The instrument must be returned to AEMC® Instruments for corrective action.

Error codes 20, 22, 23, and 24 identify semi-fatal errors. The instrument must be returned to the factory for corrective action.

Error 20 Communication failed

Error 21 Check of options failed

Error 22 Check of contents failed

Error 23 Check of calibration values failed

Error 24 Check of instrument identification number failed

Error 25 Check of print file failed

For non-fatal errors 21 and 25, it is not necessary to return the instrument. Simply use the SET-UP mode to restore the default parameters (Set Default Parameter).

Data Storage Error: When it is impossible to store data, the entire memory must be erased using the “Clear Memory” function in the SET-UP mode (see § 3.9).

4. MEASUREMENT FUNCTIONS

4.1 AC/DC VOLTAGE

- Turn the rotary selector switch to any insulation position (other than OFF or SET-UP).
- The instrument is now automatically in AC/DC voltage measurement mode.
- The voltage between the input terminals is measured at all times and indicated on the display next to the input voltage heading.
- Also, as soon as the switch is turned, the frequency and the residual DC current at the terminals of the instrument are measured. The residual current is measured in order to evaluate its effect on the insulation measurement about to be performed.

NOTE: Measurement is prohibited if an external voltage above a preset value is present at the terminals before pressing START/STOP.



Similarly, if an interference voltage of a preset value is detected during measurement, the measurement is stopped and that voltage is indicated (see V Disturbance / V Output on page 25).

4.2 INSULATION MEASUREMENT

When the switch is turned to an insulation resistance measurement position, one of following appears:

Example 1

You select an insulation measurement with a fixed/standard test voltage, in manual mode.

Switch Positions:

- 500 V - 2 TΩ
- 1000 V - 4 TΩ
- 2500 V - 10 TΩ
- 5000 V - 10 TΩ

FIXED VOLTAGE	
2500 V	
Input voltage	△ 230V AC
Frequency	50.0 Hz
Input current	24.6nA
Date: 09.28.2003	Time: 22:39

Example 2

You select an insulation measurement with one of the selectable test voltages.

Switch Position: **50 to 5000 V**

You can choose from one of the three selected voltages predefined in SET-UP using the ▲ and ▼ buttons, selecting adjustable voltage 1, 2 or 3, or define another voltage by selecting it with the ► button to highlight the test voltage and adjusting it with the ▲ and ▼ buttons. The new selected voltage will not be saved when the instrument is shut off or the rotary switch is moved to another position.

ADJUSTABLE VOLTAGE 2	
2300 V	
Input voltage	20V AC
Frequency	50.0 Hz
Input current	24.6nA
Date: 09.28.2003	Time: 22:39

Example 3

You select an insulation measurement with a test voltage that varies in steps (this is the "Step Function" mode).

Switch Position:

Step Voltage

You can choose from the three stored step voltage schemes using the ▲ and ▼ buttons.

STEP FUNCTION 1	
Min: 2300V	Max: 3900V
	
Test Run Time 08:38:30	
Input voltage	1V AC
Frequency	50.0 Hz
Input current	24.6nA
Date: 09.28.2003	Time: 22:39

- Pressing the **START/STOP** button will begin the measurement process immediately.

If the beeper is selected as "ON" in the SET-UP mode, an audible beep is emitted every 10 seconds to indicate that a test is in process.

Some special functions can be performed during the test and are described in Chapter 3.



WARNING: Insulation measurements cannot be started if there is an excessively high external voltage on the "+" and "-" terminals.

The Model 5070 will automatically inhibit testing.

- **When the START button is pressed**, if the external voltage of the terminals of the Model 5070 is greater than the value V peak defined in the set-up mode and described next, the insulation test is not started and an audible alarm is emitted; the instrument then returns to automatic voltage measurement mode.

$$V_{\text{peak}} \geq dISt \times V_N$$

Where:

- V_{peak} is the external voltage, (peak or DC) at the + and – terminals of the Model 5070.
- $dISt$ is the coefficient that can be selected in SET-UP at 3% (default value), 10 or 20%.
- V_N is the test voltage selected for the insulation measurement.

Example A: The test is to be conducted at 2500 V, $dISt$ is set to 3%. Therefore, before the test starts, a voltage present at the “+” and “-” terminals of 75 V will cause the Model 5070 to inhibit testing. ($V_{\text{peak}} = (0.03 \times 2500 \text{ V}) = 75 \text{ V}$)

Similarly, if during the insulation test, an external voltage greater than the V_{peak} (as defined below) is detected, the measurement will stop and the  symbol will appear next to the value of the external voltage measured.

$$V_{\text{peak}} \geq (dISt + 1.05) \times V_N,$$

Where

- V_{peak} is the external voltage, (peak or DC) at the + and – terminals of the Model 5070.
- $dISt$ is the coefficient that can be selected in SET-UP at 3% (default value), 10 or 20%.
- V_N is the test voltage selected for the insulation measurement.

Example B: If the conditions defined in Example A were programmed and the test was started, a disturbance voltage (change of voltage) of 2700 V would abort the test. ($V_{\text{peak}} = (0.03 + 1.05) (2500 \text{ V}) = 2700 \text{ V}$)

NOTE: The $dISt$ factor is selected to optimize the measurement build-up time.

If there is no leakage voltage, $dISt$ can be adjusted to its minimum value to obtain the shortest possible measurement build-up time.

If there is a large leakage voltage, $dISt$ can be increased so that the measurement will not be interrupted as soon as a negative alternation occurs during the generation of the test voltage; this helps optimize the measurement build-up time in the presence of a leakage voltage.

■ **Pressing the START/STOP button again stops the measurement**

If the “programmed time test” mode (Timed Run or Timed Run + DD) was selected as the test mode, the measurement is stopped (without pressing the **START/STOP** button) at the end of the test time.

Similarly, if the DAR or PI mode is selected as measurement mode before the test, the measurement is stopped automatically after the time programmed to calculate them has occurred (time defined in SET-UP).

A number of special functions can be used during the measurement (see § 3).

4.3 CAPACITANCE MEASUREMENT

The capacitance measurement is performed automatically during the insulation measurement, and is displayed after the measurement stops and the circuit has been discharged.

4.4 RESIDUAL CURRENT MEASUREMENT

The residual current circulating in the installation is measured and displayed automatically upon connection to the installation, it is all measured during and after the insulation measurement.

5. OPERATION



NOTE: Charge the instrument fully before use.

5.1 PERFORMING MEASUREMENTS

- To begin an insulation resistance test, first insert the cables as necessary, then turn the rotary switch to the appropriate test voltage position.
 - The instrument can measure insulation values from 10 k Ω to 10 T Ω , depending on the test voltage selected from 40 to 5100 Vdc.

The screen displays:

- The battery symbol and battery charge condition.
- The test voltage selected.
- The voltage, frequency and residual current at the input terminals.
- The date and time.

FIXED VOLTAGE	
2500 V	
Input voltage	Δ 230V AC
Frequency	50.0 Hz
Input current	24.6nA
Date: 09.28.2003	Time: 22:39

- Connect the Red (+) and the Black (-) cables to the test object. Connect the Blue Guard jumper and cable, if required for the test (see Appendix A "Utilizing the Guard Terminal").
- Next, (unless the step function mode is selected) select the measurement mode to be used (Manual Stop, Manual Stop + DD, Timed Run, Timed Run + DD, DAR or PI) by pressing the **MODE** button (see § 3.2.1)
- Press the **START/STOP** button to begin the measurement test.



If the voltage present is greater than the maximum allowed value, the measurement will be prohibited.

- The **DISPLAY** button can be used to scroll through the information available during the test.
- This information depends on the measurement mode selected (see § 3.2.1).
- If the insulation values displayed are very unstable, a digital filter can be activated by pressing **SMOOTH** to smooth them (see § 3.5.2).
- The alarm mode can be activated by pressing the **ALARM** button. An audible beep will continuously sound if the measurement result is below the value defined in SET-UP (see page 14).
- Press the **START/STOP** button again to stop the test.
- The last result remains displayed until the next measurement is made or the switch is turned.
- When the insulation measurement has stopped, the device under test will be automatically discharged by the Model 5070.

- The **DISPLAY** button can be used to view the test results available after the test.
- This information depends on the measurement mode selected (see § 3.2.1).
- If the measurement mode was either “Timed Run” or “Timed Run + DD”, pressing the **GRAPH** button displays the insulation measurement versus time curve (see § 3.3.2).
- Press the **TEMP** button to correct the measurement result to the reference temperature defined in SET-UP (see § 3.10).

5.2 STEP FUNCTION MODE

This function is based upon the principle that ideal insulation produces the same resistance no matter what the test voltage applied.

Any negative variation of this resistance means that the insulation may be defective. The resistance of defective insulation will decrease as the test voltage increases.

This phenomenon is rarely observed with “low” test voltages, therefore at least 2500 V must be applied.

The usual test condition is a voltage increasing in 5 steps, each lasting for 1 minute minimum.

Assessment of the result:

- A deviation of the resistance = f(test voltage) curve that exceeds 500 ppm/V generally indicates the presence of mold or other deterioration.
- A larger deviation or a sudden drop indicates the presence of localized physical damage such as arcing or perforation of the insulation, etc.

Procedure:

- In the SET-UP menu, select “Set Step Function 1, 2 or 3” by scrolling down to set Step Function 1, 2, or 3 using the ▼ button. Press the ► button to enter the Set-up mode for the profile selected. The screen on the right shows the default profile for Step Function Number 3.

SET-UP		
Ramp 3 definition:		
Step	Voltage	Duration (h:m)
▣ 1	1000V	01:00
2	2000V	01:00
3	3000V	01:00
4	4000V	01:00
5	5000V	01:00
Total duration (h:m)		05:00
R(t) sample (m:s)		00:20

- Define the Step Function and the desired number of measurement samples (R(t) sample) by scrolling to the desired Step using the ▲ or ▼ buttons followed by the ► button to access the selected steps, voltage and time variables. Adjust the voltage for the Step by pressing the ▲ or ▼ buttons. Then, press the ► button to move the selection cursor to the duration setting. Adjust the hours and minutes for the step in the same fashion used to select the voltage. When finished, press the ► button until the cursor is again in the Step Column. Repeat this process for each of the five steps.



If a Step is not used, select “---” as the duration. Next, adjust the sample rate by the same procedure using the ▲ ▼ and ◀▶ buttons to select and adjust the sample rate.

- Once the Step Function is defined, turn the selector switch to Step Voltage (the desired profile 1, 2, or 3) using the ▲ ▼ buttons.
- Then, start the measurement by pressing the **START/STOP** button.

During the measurement, the following screens can be accessed by pressing the **DISPLAY** button:

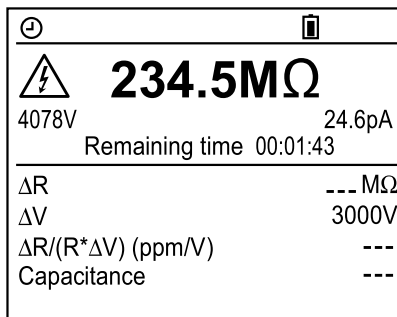
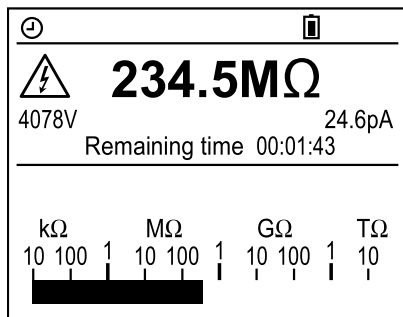

At the end of the measurement, the following are indicated:

- The difference ΔR in insulation resistance between the final resistance (with the highest test voltage) and the initial resistance (with the lowest test voltage).
- The difference ΔV between the final and initial test voltages.
- The slope of the curve in ppm/V.
- The capacitance.

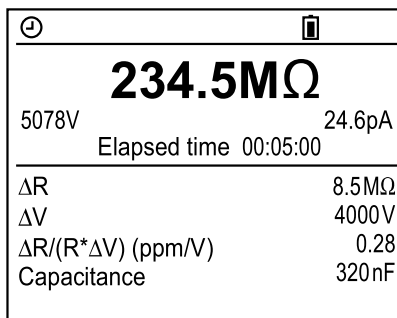

Pressing the **GRAPH** button displays the resistance versus applied test voltage curve.

Using the ◀ and ▶ buttons, you can scroll through the various samples recorded and for each see:

- The insulation resistance value.
- The applied test voltage.
- The time of measurement.

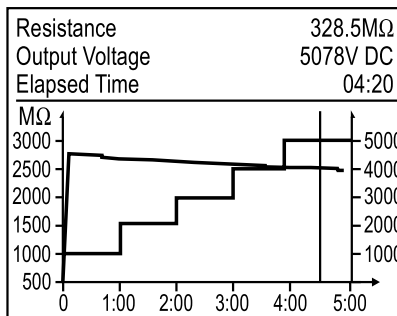

5.3 OPERATION EXAMPLES

Connection diagram for measurement of low resistance insulation (e.g. motor)

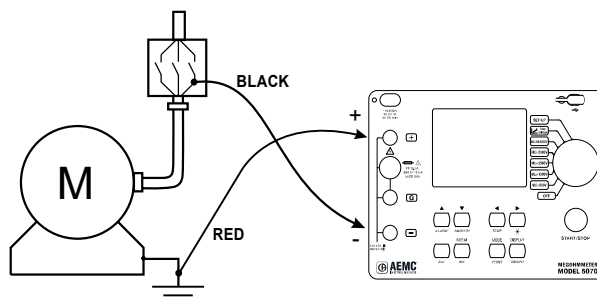

When measuring high levels of insulation (>1 GΩ), it is advisable to use the “G” guard terminal to eliminate the influence of surface leakage currents. The guard is connected between the two measurement contact points, and the surface susceptible to surface currents, (e.g. dusty, damp cable or transformer insulation). In this case, alligator clips are preferable to hand-held test probes.

As soon as the insulation measurement is stopped, the test circuit is automatically discharged using the instrument's internal discharge feature.

Connection diagram for measurement of high resistance insulation

a) Example of a motor (reduction of capacitive effects)

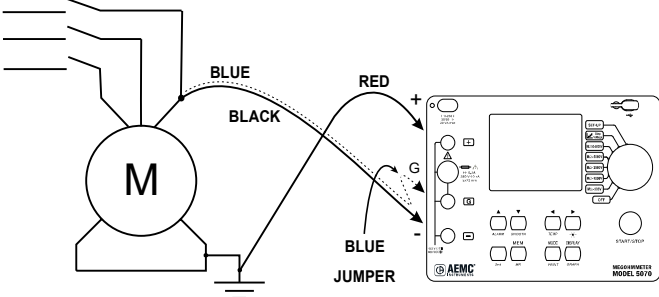

b) Example of a cable (reduction of superficial leak effects)

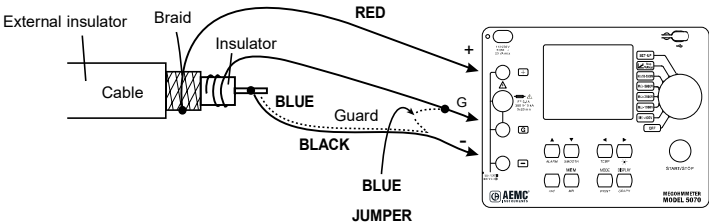

6. DATAVIEW® SOFTWARE

6.1 INSTALLING DATAVIEW



For complete information on using the Megohmmeter with DataView, refer to the Help Menu within the Megohmmeter Control Panel in DataView.



DO NOT CONNECT THE INSTRUMENT TO THE PC BEFORE INSTALLING THE SOFTWARE AND DRIVERS.

1. Insert the DataView thumb drive into an available USB port on your computer. If Autorun is enabled, an AutoPlay window appears on your screen. Click “Open folder to view files” to display the DataView folder. If Autorun is not enabled or allowed, use Windows Explorer to locate and open the USB drive labeled “DataView.”
2. When the DataView folder is open, find the file Setup.exe located in the root directory of the USB drive, and double-click it to run the installation program.
3. The DataView setup screen appears.
 - In the upper left corner of the screen, choose the language version of the Setup interface. The Setup screens and dialogs will immediately appear in the selected language.

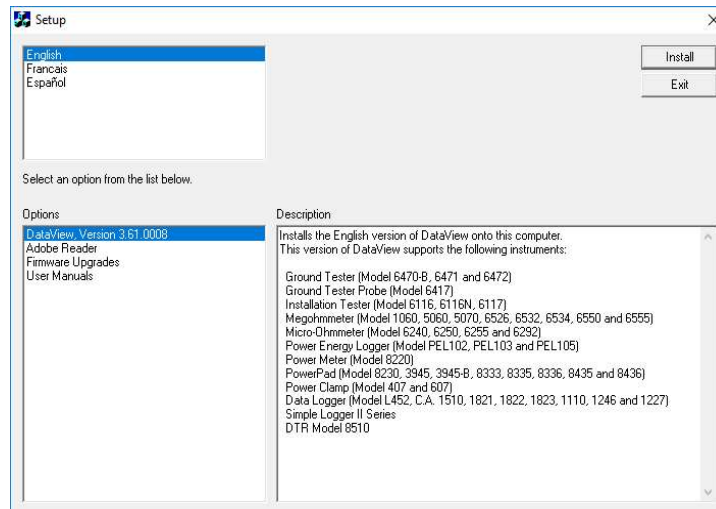

- In the lower left corner are the available installation options. In addition to the DataView software, you can select “Adobe Reader.” This links to the Adobe web site where you can download the latest version of Reader. This program is required to view DataView .pdf documents. The option Firmware Upgrades links to the website where you can check for new firmware updates for the instrument. Finally, User Manuals displays a list of .pdf files contained in the USB drive that accompanies DataView. DataView also comes with a Help system that is installed with the program files.
 - To install DataView, select DataView in the Options list and click Install.
4. Select the language version of DataView you want to install (English, French, or Spanish) then click Next. By default, the language selected in step 3 is highlighted.)

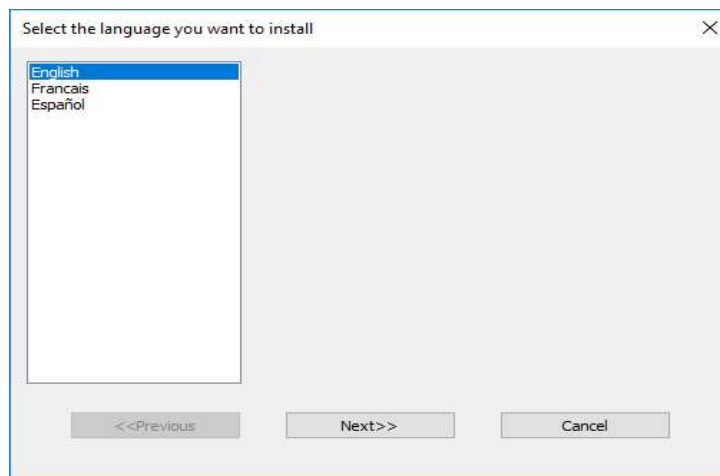

5. You are now prompted to select the software you want to install. Each AEMC Instruments product family has its own specially designed Control Panel. If you are performing a Complete install, every available Control Panel is selected by default. Control Panels take up disk space on the computer, so we recommend that you select Megohmmeter and deselect the rest unless you have other types of AEMC instruments. You should also check the option for the DataView Core, which is a requirement if you plan to create DataView reports.
- After you finish selecting and deselecting Control Panels and/or DataView Core, click Next.
6. The Setup program now informs you that it is ready to install DataView. If you want to review any of your previous selections, click the Previous button to return to earlier screens. Otherwise, click Install to begin installation.

7. The InstallShield program installs the selected software. If an earlier version of the software is already installed on your computer, for each selected program the InstallShield program will:
 - (a) Ask you to confirm the installation of the program. Click Next.
 - (b) Display a status bar indicating the progress of the installation.
 - (c) Inform you when the program is installed.Click Finish to install the next selected program.
 - If the software is not installed or the installed software is the same version as the selected software, the software is installed without requesting confirmation.
 - When all programs are installed, a message appears informing you of this. Click Finish to return to the Setup screen
8. You can now select additional Setup options to install (see step 3 above). When finished, click Exit.
9. The DataView folder will appear on your computer desktop and contain the Megohmmeter  icon and the icons for any other installed Control Panels.

6.2 MEGOHMMETER CONTROL PANEL

- Clicking on the DataView icon in the DataView folder on your desktop will open the core DataView program.
- Clicking on the Megohmmeter Control Panel icon will open the Megohmmeter Control Panel.

In general, core DataView features are for creating, viewing, editing, and storing DataView reports. The Control Panel is for connecting to, configuring, viewing measurements on, and downloading data from the instrument. You can access all DataView features through either the DataView icon or the Control Panel icon. For users who interact with megohmmeter instruments, we recommend primarily using the Control Panel. However, there are situations where using the core DataView icon may be more convenient, like viewing multiple archived reports from different product families from AEMC® Instruments.

For further information about using the Megohmmeter Control Panel, consult the Help system that comes with the product. You can access this Help by clicking the option Help at the top of the Control Panel's screen or by pressing F1 in the program.

7. SPECIFICATIONS

7.1 REFERENCE CONDITIONS

Influence Quantity	Reference Values
Temperature	23°C ± 3°K
Relative Humidity	45 to 55%
Supply Voltage	9 to 12 V
Frequency Range	DC and 15.3 to 65 Hz
Capacitance in parallel with the input resistance	0μF
Electric Field	nil
Magnetic Field	<40 A/m

7.2 VOLTAGE

Measurement Range	1.0 to 99.9 V	100 to 999 V	1000 to 2499 V	2500 to 4000 V
Frequency Range*	DC and 15 to 500 Hz			DC Only
Resolution	0.1 V	1 V	2 V	2 V
Accuracy	1% of Reading ± 5 cts		1% of Reading ± 3 ct	
Input Impedance	750 kΩ at 3 MΩ depending on measure voltage			

*Over 500 Hz, the small display indicates “- - -” and the main display gives only an assessment of the peak value of the measured voltage.

Measurement Category: 1000 V CAT III (transients ≤2.5 kV)

7.3 INSULATION RESISTANCE

Method: Voltage-current method according to EN 61557-2 (ed. 02/97)

Nominal Output Voltage: 500, 1000, 2500, 5000 V_{DC} (or selectable from 40 to 5100 V)

Adjustments Available in Variable Mode: 10 V from 40 to 1000 V
100 V from 1000 to 5100 V

Open-circuit Voltage: ≤1.02 × U_n ± 2% (V_n ± 2% in variable mode)

Max. Overload of Voltage V_n: (1.05 + dISt) V_n + 50 V
with dISt = 3%, 10%, or 20%

NOTE: V_n = Test Voltage

Nominal Current: >1 mA_{DC}

Short-circuit Current: <1.6 mA ± 5%

Load Current: 3 mA_{DC} approx when starting measurement

NOTE: dISt is the ratio of V Disturbance/V Output and is selectable in SET-UP mode.

Measurement Ranges:

500 V: 30 kΩ to 1.999 TΩ 2500 V: 100 kΩ to 9.99 TΩ

1000 V: 100 kΩ to 3.999 TΩ 5000 V: 300 kΩ to 9.99 TΩ

Variable: 40 to 5100 V (see graph below)

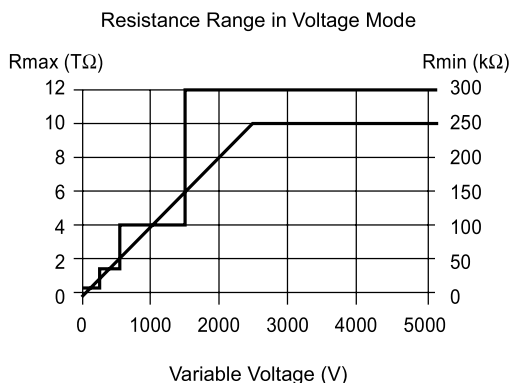

Resolution and Accuracy Chart (see curves - pages 14 and 15):

Test Voltage	500 V	500 V - 1000 V	500 V - 1000 V - 2500 V - 5000 V			
Range	30 to 99 kΩ	100 to 299 kΩ	300 to 999 kΩ	1.00 to 3.999 MΩ	4.00 to 39.99 MΩ	40.0 to 399.9 MΩ
Resolution	1 kΩ			10 kΩ	100 kΩ	
Accuracy	±5% of Reading + 3 cts					

Test Voltage	500 V - 1000 V - 2500 V - 5000 V				1000 V - 2500 V 5000 V	2500 V 5000 V
Range	400 MΩ to 3.999 GΩ	4.00 to 39.99 GΩ	40.0 to 399.9 GΩ	400 GΩ to 1.999 TΩ	2.000 to 3.999 TΩ	4.00 to 9.99 TΩ
Resolution	1 MΩ	10 MΩ	100 MΩ	1 GΩ		10 GΩ
Accuracy	±5% of Reading + 3 cts			±15% of Reading + 10 cts		

DC Voltage Measurement (during insulation test):

Range	Resolution	Accuracy
40.0 to 99.9 V	0.1 V	1% of Reading ± 1 ct
100 to 1500 V	1 V	
1501 to 5100 V	2 V	

DC Voltage Measurement (after insulation test):

Range	Resolution	Accuracy
25 to 5100 V	0.2% Vn	5% of Reading \pm 3 cts

Typical build-up time for the measurement according to components tested (Vdist = 0.03 Vn).

These values include the influences caused by the charge of the capacitive component, by the automatic range system and to the test voltage control.

Test Voltage	Load	Non-capacitive (unsmoothed)	With capacitance of 1 μ F (smoothed)
500 V	1 M Ω	3 s	4 s
	100 G Ω	8 s	40 s
1000 V	1 M Ω	3 s	4 s
	100 G Ω	8 s	80 s
2500 V	3 M Ω	3 s	4 s
	100 G Ω	8 s	90 s
5000 V	5 M Ω	4 s	16 s
	100 G Ω	8 s	120 s

Typical discharge time for a capacitive component to reach 25 Vbc:

Initial Voltage	500 V	1000 V	2500 V	5000 V
Discharge time (C in μ F)	C x 3 s	C x 4 s	C x 4 s	C x 7 s

Capacitance Measurement (after discharge of tested component):

Range	Resolution	Accuracy
0.005 to 9.999 μ F	1 nF	10% of Reading \pm 1 ct
10.00 to 49.99 μ F	10 nF	

Leakage Current Measurement

Range	Resolution	Accuracy
0.000 to 0.250 nA	1 pA	15% of Reading \pm 10 cts
0.251 to 9.999 nA		10% of Reading
10.00 to 99.99 nA	10 pA	5% of Reading
100.0 to 999.9 nA	100 pA	
1.000 to 9.999 μ A	1 nA	
10.00 to 99.99 μ A	10 nA	
100.0 to 999.9 μ A	100 nA	
1000 to 3000 μ A	1 μ A	10% of Reading

Typical changes in test voltages as a function of the load:

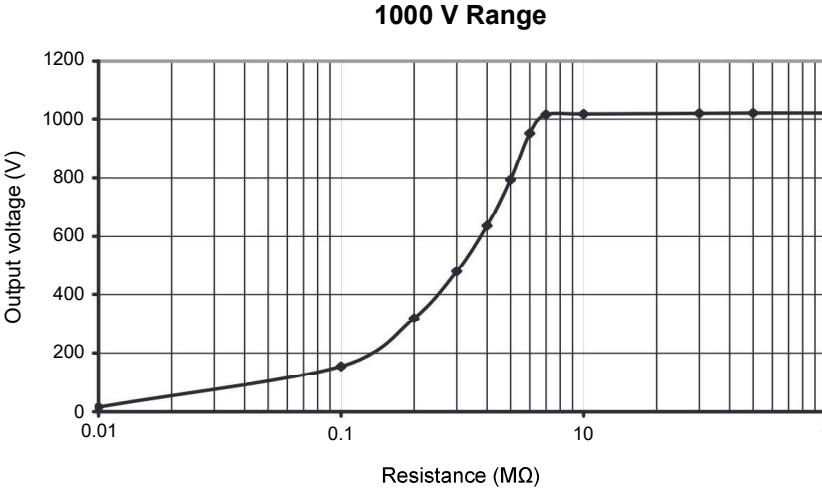
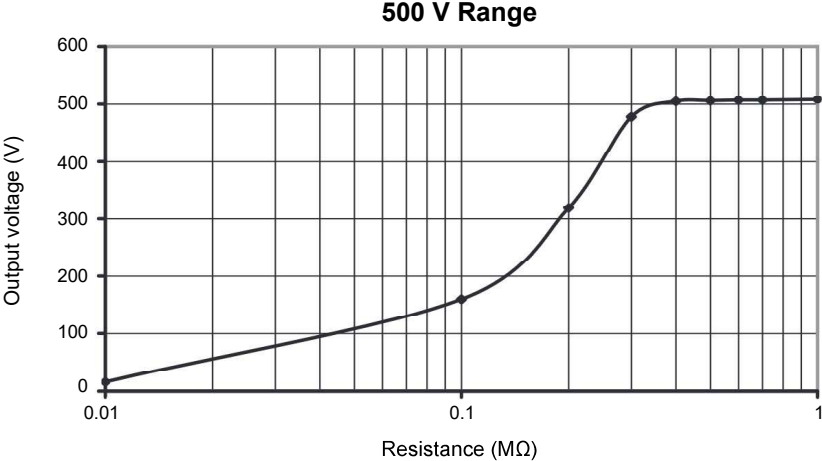

2500 V Range

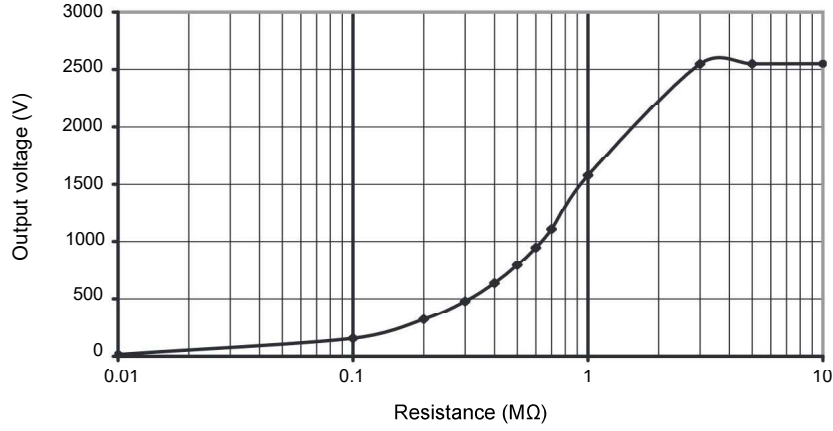

5000 V Range

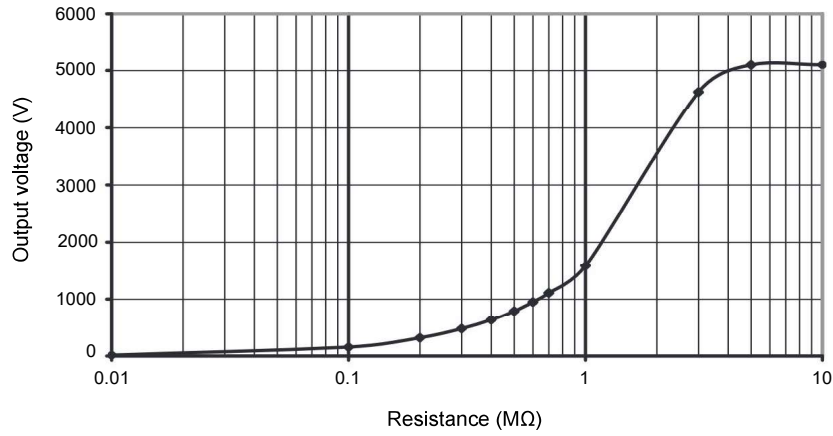

Calculation of Terms DAR and PI

Range	Resolution	Accuracy
0.02 to 50.00	0.01	5% of Reading \pm 1 ct

Calculation of Term DD

Range	Resolution	Accuracy
0.02 to 50.00	0.01	10% of Reading \pm 1 ct

7.4 POWER SUPPLY

- Rechargeable battery NiMH (8 x 1.2 V / 3.5 Ah)
- Recharge: 85 to 256 V / 50-60 Hz

Minimum Battery Charge Life (per NF EN 61557-2)

Test Voltage	Nominal Charge	Number of Measurements 5 s on nominal charge (with 25 s pause between each measurement)
500 V	500 k Ω	6500
1000 V	1 M Ω	5500
2500 V	2.5 M Ω	4000
5000 V	5 M Ω	1500

Average Battery Life:

The operating time will be 15 days or 3 weeks based on a 10 minute PI measurement

Recharge Time:

6 hours for 100% capacity (10 hours if the battery is completely drained)
0.5 hours for 10% capacity (charge life: 2 days approximately)



NOTE: It is possible to recharge the batteries while performing insulation measurements provided that the values measured are higher than 20 M Ω . In this case, the recharging time is higher than 6 hours and depends on the frequency of the measurements.

7.5 ENVIRONMENTAL SPECIFICATIONS

Operating Range:

14° to 104°F (-10° to 40°C) during recharging of batteries
14° to 131°F (-10° to 55°C) during measurement
10 to 80% RH

Storage: -40° to 158°F (-40° to 70°C); 10 to 90% RH

Altitude: <2000 m

7.6 MECHANICAL SPECIFICATIONS

Case Dimensions (LxWxH):

10.63 x 9.84 x 7.09" (270 x 250 x 180 mm)

Weight: 9.5 lbs (4.3 kg) approximately

7.7 SAFETY SPECIFICATIONS

Electrical safety as per: IEC/EN 61010-2-030 or BS EN 61010-2-030, IEC 61557



Double insulation:

1000 V CAT III

Pollution Degree 2

Electromagnetic Compatibility:

Electrical safety as per IEC/EN 61010-2-030 or BS EN 61010-2-030, IEC 61557

Mechanical Protection:

IP 53 per NF EN 60529 (Ed. 92)

IK 04 per NF EN 50102 (Ed. 95)

7.8 VARIATIONS IN OPERATING RANGE

Influential Quantity	Range of Influence	Quantity Influenced*	Influence	
			Typical	Max
Battery Voltage	9 to 12 V	V	<1 ct	2 cts
		MΩ	<1 ct	3 cts
Temperature	14 to 131°F (-10° to +55°C)	V	0.15% / 10°C	0.3% / 10°C +1 ct
		MΩ	0.20% / 10°C	1% / 10°C + 2 ct
Humidity	10 to 80% RH	V	0.2% R	1% R ± 2 cts
		MΩ (10 kΩ to 40 GΩ)	0.2% R	1% R ± 5 cts
		MΩ (40 GΩ to 10 TΩ)	3% R	15% R ± 5 cts
Frequency	15 to 500 Hz	V	0.3% R	0.5% R ± 1 ct
AC voltage superimposed on test voltage	0% to 20% Vn	MΩ	0.1% R / % Vn	0.1% R / % Vn ± 5 cts

*The terms DAR, PI, DD, and the capacity and current leak measurements are included in the quantity "MΩ."

8. MAINTENANCE

Make sure to use only factory-specified replacement parts. The battery should be replaced by an authorized repair facility recognized by AEMC® Instruments; otherwise, AEMC® Instruments will not be held responsible for any accident, incident, or malfunction following a repair not completed by its service center or an approved repair center.

8.1 RECHARGING THE BATTERY

If the battery symbol  on the display flashes, the battery needs to be charged. Connect the instrument to the 120 VAC power cord via the connector (charging starts automatically even if the instrument is turned off).

- **If the instrument is charging in the OFF position**, the battery symbol is displayed, and the 3 bars flash throughout the charging - “Charging battery” is also indicated. When the battery is full, the symbol and its 3 bars are lit steadily, and “Charging Full” is indicated.
- **If the instrument is charging in a measurement position**, The battery symbol will flash. The instrument will not indicate when the battery is full in a measurement procedure. The instrument only indicates that the battery is full when the instrument is returned to the OFF position.

If the instrument is turned on and the battery voltage is >8 V, then the normal use of the device is permitted.



WARNING: Changing the battery causes data loss from the memory.

Press the **MEM/MR** button (“**OFF**” is displayed). Proceed with a total clearing of memory in SET-UP (see § 3.8) so the MEM/MR functions can be used again.

8.2 FUSE REPLACEMENT

If **GUARD FUSE** appears on the display, the fuse must be replaced. Take all the necessary precautions when opening up the instrument.



WARNING: Make sure that no terminals are connected and that the selector switch is set to the OFF position before opening the case.

Only use the type of fuse listed in § 1.3.1.

8.3 CLEANING



WARNING: Disconnect the instrument from any source of electricity.

- Use a soft cloth lightly dampened with soapy water. Rinse with a damp cloth and then dry with a dry cloth.
 - Do not get water inside the case. This may lead to electrical shock or damage to the instrument.
 - Do not use alcohol, solvents, or hydrocarbons.
-

8.4 STORAGE

If the instrument is not used for an extended time period (longer than two months), we recommend completely charging and discharging the battery three times before re-using the instrument.

Complete battery discharge can be performed:

- By removing the battery from the instrument and applying a 3 A load to it.
- On the 5000 V position with the backlight on (consumes the most power).

8.5 REPAIR AND CALIBRATION

To ensure that your instrument meets factory specifications, we recommend that it be scheduled back to our factory Service Center at one-year intervals for recalibration, or as required by other standards or internal procedures.

For instrument repair and calibration:

You must contact our Service Center for a Customer Service Authorization Number (CSA#). This will ensure that when your instrument arrives, it will be tracked and processed promptly. Please write the CSA# on the outside of the shipping container. If the instrument is returned for calibration, **we** need to know if you want a standard calibration, or a calibration traceable to N.I.S.T. (Includes calibration certificate plus recorded calibration data).

Ship To:

(Or contact your [authorized distributor](#))

Contact us for the costs for repair, standard calibration, and calibration traceable to N.I.S.T.

NOTE: All customers must obtain a CSA# before returning any instrument.

8.6 TECHNICAL AND SALES ASSISTANCE

If you are experiencing any technical problems, or require any assistance with the proper operation or application of your instrument, please call, mail, fax, or e-mail our technical support team:

8.7 LIMITED WARRANTY

The Megohmmeter Model 5070 is warranted to the owner for a period of two years from the date of original purchase against defects in manufacture. This limited warranty is given by AEMC® Instruments, not by the distributor from whom it was purchased. This warranty is void if the unit has been tampered with, abused or if the defect is related to service not performed by AEMC® Instruments.

Full warranty coverage and product registration is available on our website at [_____](#)

Please print the online Warranty Coverage Information for your records.

What AEMC® Instruments will do:

If a malfunction occurs within the warranty period, you may return the instrument to us for repair, provided we have your warranty registration information on file or a proof of purchase. AEMC® Instruments will, at its option, repair or replace the faulty material.

8.8 WARRANTY REPAIRS

What you must do to return an Instrument for Warranty Repair:

First, request a Customer Service Authorization Number (CSA#) by phone or by fax from our Service Department (see address below), then return the instrument along with the signed CSA Form. Please write the CSA# on the outside of the shipping container. Return the instrument, postage or shipment pre-paid to:

Ship To:

Caution: To protect yourself against in-transit loss, we recommend you insure your returned material.

NOTE: You must obtain a CSA# before returning any instrument.

APPENDIX A. UTILIZING THE GUARD TERMINAL

- Guard terminals are useful when measuring high resistance values and for stabilizing readings.
- Surface leakage is fundamentally a low resistance path in parallel with the most important resistance path through the body of the insulation. The guard terminal can be used to stop the effects of the surface leakage from influencing the measurement of resistance through the insulation. In the example of a cable, shown in the diagram below, connecting the guard terminal of the Model 5070 to the surface of the insulation will redirect surface leakage currents away from the true measured value of leakage current from the conductor through the insulation.
- The use of the guard terminal is most important when there is a significant exposed surface in a cable. When testing the insulation at the end of a cable, it is necessary to eliminate the error from surface leakage which occurs, particularly at high resistance values. The guard terminal provides a third terminal within the path of the surface leakage. Connect the instrument as shown in Figure A-1.

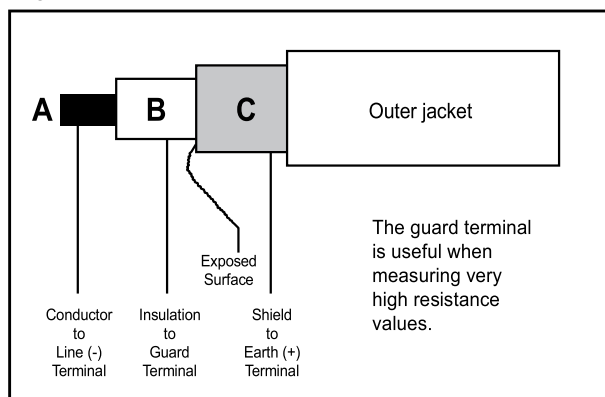

Figure A-1 - Shielded Cable

- Connect the black (-) test lead to the conductor at A.
- Connect the red (+) test lead to the shield layer of the cable at C.
- Connect the blue Guard (G) lead to the insulation layer of the cable at B.

If there is no shield, use a copper wire wound several times around the exposed surface. (Note: If a shield is not available and you do not make up a shield around "B" and connect to the guard terminal (-), the measurement will be

erroneous and lead to confusion as to the cable's condition). If the guard terminal is not connected at "B", the instrument measures the current "i" flowing through the insulation and a surface leakage current "i₁". See Figure A-2.

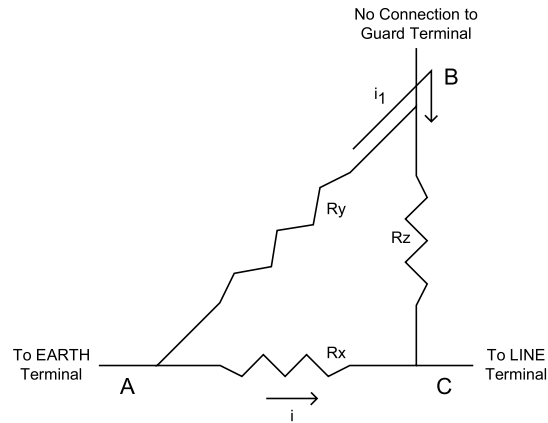

Figure A-2 - No Guard Terminal Connected

With the guard terminal connected, the surface leakage i₁ is removed and has no effect on the reading. See Figure A-3.

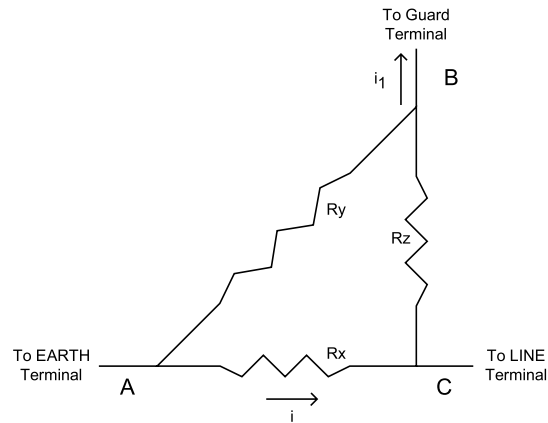

Figure A-3 - Guard Terminal Connected

APPENDIX B. V DISTURBANCE/V OUTPUT FEATURE

The V Disturbance/V Output feature (referred to in the text of this manual as dISt) serves two purposes.

First it acts as a safety device inhibiting the instrument from generating a test voltage when live signals are present.

In the SET-UP mode, you can choose a percentage of the test voltage that constitutes a condition that requires the test to be inhibited before it starts. If the Model 5070 measures a voltage higher than the V Disturbance/V Output setting allows, no test voltage will be generated when the Start button is pressed.

The calculation for this condition is simple. In the set up mode, you have a choice to set the ratio for V Disturbance/V Output (stated as dISt) to 3, 10 or 20%. The inhibit voltage is then calculated by multiplying this percentage times the test voltage.

Example: Test voltage is set to 500 and the V Disturbance/V Output is set to 3% therefore the voltage present at the input terminals before the start of a test that will inhibit testing is $(500)(0.03) = 15$ V. The table below shows the inhibit voltages for the 4 fixed test voltage positions and the three V Disturbance/V Output percentages.

Before Testing

Test Voltage	V Disturbance/V Output		
	3%	10%	20%
500	15	50	100
1000	30	100	200
2500	75	250	500
5000	150	500	1000

If a sudden change in voltage occurs during the test, the formula for calculating V Disturbance/V Output is slightly different. It is $(V \text{ Output})(1.05 + \text{dISt})$. Using 500 V as the test voltage and 3% as dISt, the inhibit voltage that must occur after a test is started is $(500)(1.05 + .03) = 540$ volts. The table below shows the inhibit voltages for the 4 fixed test voltage positions and the three V Disturbance/V Output percentages that must occur after a test starts.

During a Test

Test Voltage	V Disturbance/V Output		
	3%	10%	20%
500	540	575	625
1000	1080	1150	1250
2500	2700	2875	3125
5000	5400	5750	6250

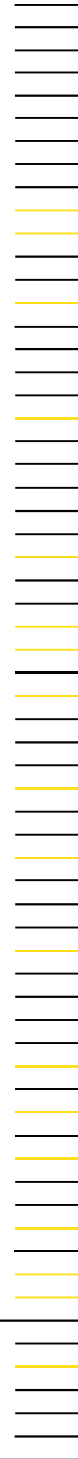

© Chauvin Arnoux, Inc. d.b.a. AEMC Instruments. All Rights Reserved.