



Combustion Analyzer

for Commercial & Light Industrial Use



Combustion & Emissions

P/N: 0024-9551 | July 2018 Revision 1

User Manual

WARRANTY POLICY

Bacharach, Inc. warrants to buyer that at the time of delivery this product will be free from defects in material and manufacture and will conform substantially to Bacharach, Inc.'s applicable specifications. Bacharach's liability and buyer's remedy under this warranty are limited to the repair or replacement, at Bacharach's option, of this product or parts thereof returned to seller at the factory of manufacture and shown to Bacharach, Inc.'s reasonable satisfaction to have been defective; provided that written IMPORTANT of the defect shall have been given by buyer to Bacharach, Inc. within one (1) year after the date of delivery of this product by Bacharach, Inc.

Bacharach, Inc. warrants to buyer that it will convey good title to this product. Bacharach's liability and buyer's remedy under this warranty of title are limited to the removal of any title defects or, at the election of Bacharach, to the replacement of this product or parts thereof that are defective in title.

THE FOREGOING WARRANTIES ARE EXCLUSIVE AND ARE GIVEN AND ACCEPTED IN LIEU OF (I) ANY AND ALL OTHER WARRANTIES, EXPRESS OR IMPLIED, INCLUDING WITHOUT LIMITATION THE IMPLIED WARRANTIES OF MERCHANTABILITY AND FITNESS FOR A PARTICULAR PURPOSE: AND (II) ANY OBLIGATION, LIABILITY, RIGHT, CLAIM OR REMEDY IN CONTRACT OR TORT, WHETHER OR NOT ARISING FROM BACHARACH'S NEGLIGENCE, ACTUAL OR IMPLIED. The remedies of the buyer shall be limited to those provided herein to the exclusion of any and all other remedies including, without limitation incidental or consequential damages. No agreement varying or extending the foregoing warranties, remedies or this limitation will be binding upon Bacharach, Inc. unless in writing, signed by a duly authorized officer of Bacharach.

SERVICE POLICY

Bacharach, Inc. maintains a service facility at the factory. Some Bacharach distributors / agents may also have repair facilities; however, Bacharach assumes no liability for service performed by anyone other than Bacharach personnel. Repairs are warranted for 90 days after date of shipment (*sensors, pumps, filters and batteries have individual warranties*). Should your analyzer require non-warranty repair, you may contact the distributor from whom it was purchased or you may contact Bacharach directly.

If Bacharach is to do the repair work, send the monitor, prepaid, to the closest service center.

Prior to shipping equipment to Bacharach, visit _____ for an Returned Merchandise Authorization Number (RMA #). All returned goods must be accompanied with an RMA #. Pack the equipment securely (*in its original packing, if possible*), as Bacharach cannot be held responsible for any damage incurred during shipping to our facility.

Always include your RMA #, shipping address, telephone number, contact name, billing information and a description of the defect as you perceive it. You will be contacted with a cost estimate for expected repairs prior to the performance of any service work. For liability reasons, Bacharach has a policy of performing all needed repairs to restore the monitor to full operating condition.

IMPORTANT

Product improvements and enhancements are on-going, therefore the specifications and information contained in this document may change without IMPORTANT.

Bacharach, Inc. shall not be liable for errors contained herein or for incidental or consequential damages in connection with the furnishing, performance, or use of this material.

No part of this document may be photocopied, reproduced, or translated to another language without the prior written consent of Bacharach, Inc.

Copyright © 2018, Bacharach, Inc., All Rights Reserved.

BACHARACH, PCA, B-SMART, and FYRITE are registered trademarks of Bacharach, Inc. All other trademarks, trade names, service marks and logos referenced herein belong to their respective companies.

Table of Contents

- Introduction 6**
 - 1.1 About this Manual 6
 - 1.2 Conventions..... 6
 - 1.2.1 Short Form Instructions..... 6
 - 1.2.2 Iconography..... 7
 - 1.3 General Safety Statements..... 7
 - 1.4 Product Overview 8

- Product Description..... 9**
 - 2.1 Combustion & Emissions Analyzer 10
 - 2.1.1 Overview..... 10
 - 2.1.2 Keypad..... 11
 - 2.1.3 Display..... 11
 - 2.1.4 Instrument Connections..... 13
 - 2.1.5 Interfaces 14
 - 2.1.6 Components 15
 - 2.2 Sample Line & Probe Assembly..... 16
 - 2.3 Power Configurations..... 17

- Operation..... 18**
 - 3.1 Setup..... 18
 - 3.1.1 Operation Tips..... 18
 - 3.1.2 Inspection / Prerequisites..... 20
 - 3.1.3 Connecting Probe Assembly..... 21
 - 3.2 Performing Combustion Test 22
 - 3.2.1 Combustion User Preferences 22
 - 3.2.2 Combustion Analysis 23
 - 3.2.3 Additional Settings 25
 - 3.3 Performing Pressure Test 28
 - 3.3.1 Pressure User Preferences 28
 - 3.3.2 Pressure Analysis..... 28
 - 3.4 Temperature Test 30
 - 3.4.1 Temperature User Preferences 30
 - 3.4.2 Temperature Analysis..... 30

Settings & Features..... 32

- 4.1 Language Selection..... 32
- 4.2 Date & Time 32
- 4.3 Username 33
- 4.4 Button Sound 34
- 4.5 Inactivity Timeout..... 34
- 4.6 Post-Purge Period 34
- 4.7 Carbon Monoxide (CO) Zero 34
- 4.8 Sensor Setup..... 35
- 4.9 Bluetooth® Setup 36
- 4.10 Printer Setup 37
- 4.11 Onboard Data Logging 38
- 4.12 Memory File Management..... 39
- 4.13 Fresh Air Purge without Removing Probe 40
- 4.14 Sensor Protection / Dilution Mode 41

Care & Maintenance 42

- 5.1 Emptying the Water Trap..... 42
- 5.2 Replacing the Filter Element 43
- 5.3 Cleaning the Probe Assembly..... 44
- 5.4 Sensor Replacement..... 45
- 5.5 B-Smart® Sensor Calibration 48
 - 5.5.1 B-Smart® Sensors..... 48
 - 5.5.2 Starting a Calibration 49
 - 5.5.3 B-Smart® Sensor Calibration 49
- 5.6 Manual Sensor Calibration 52
 - 5.6.1 Starting a Calibration 52
 - 5.6.2 CO_{LOW} Sensor Calibration 53
 - 5.6.3 SO₂ Sensor Calibration 56
 - 5.6.4 NO Sensor Calibration..... 57
 - 5.6.5 NO₂ Sensor Calibration 58
 - 5.6.6 CO_{HIGH} Sensor Calibration..... 60
- 5.7 Troubleshooting..... 61
 - 5.7.1 Error Codes..... 61
 - 5.7.2 Error Symbols..... 62
 - 5.7.3 Diagnostics & Status Screens..... 62

Additional Information 64

- 6.1 Technical Specifications 64
 - 6.1.1 Instrument Details 64
 - 6.1.2 Approvals 65
 - 6.1.3 Measurement Range & Accuracy..... 65
 - 6.1.4 Calculated Readings 66
- 6.2 PCA® Reporting Software 67
 - 6.2.1 Downloading Stored Data to a Computer..... 67
 - 6.2.2 Importing Saved Data..... 67
- 6.3 PCA® Reporting Software 69

Parts & Accessories..... 70

- 7.1 Part Numbers 70
- 7.2 Service Center Locations..... 72

1. Introduction

| | | |
|-------|--------------------------------|---|
| 1.1 | About this Manual | 6 |
| 1.2 | Conventions..... | 6 |
| 1.2.1 | Short Form Instructions..... | 6 |
| 1.2.2 | Iconography..... | 7 |
| 1.3 | General Safety Statements..... | 7 |
| 1.4 | Product Overview | 8 |

1.1 About this Manual

Thank you for investing in a Bacharach PCA® 400 Combustion Analyzer. To ensure operator safety and the proper use of the PCA® 400, please read the contents of this manual for important information on the operation and maintenance of the analyzer.



IMPORTANT: Before using this product, carefully read and strictly follow the instructions in the manual.

1.2 Conventions

1.2.1 Short Form Instructions

This document uses a short form for describing steps (*e.g. executing a command*).

Example:

Selecting fuel type of application being tested.







Short Form Instructions:

- ▶ To select Fuel Type: *Main Menu* → *Fuel Menu* (⚡) → select *Natural Gas, Oil #2, Oil #4, Oil #6, Propane, Coal, Wood, Kerosene, Bagasse, or Digester Gas*

Steps Required:

1. Open the Main Menu.
2. Select Fuel Menu (indicated by the ⚡ icon).
3. Select desired fuel type from the listed options.

1.2.2 Iconography

| Alert | Icon | Description |
|------------------|--|--|
| DANGER |  | Imminently hazardous situation which, if not avoided, will result in death or serious injury. |
| WARNING |  | Potentially hazardous situation which, if not avoided, could result in death or serious injury. |
| WARNING |  | Potential electrical shock hazard which, if not avoided, could result in death or serious injury. |
| WARNING |  | Hot surface which, if not avoided, could result in physical injury or damage to the product. |
| CAUTION |  | Potentially hazardous situation which, if not avoided, could result in physical injury or damage to the product or environment. It may also be used to alert against unsafe practices. |
| IMPORTANT |  | Additional information on how to use the product. |

1.3 General Safety Statements



WARNING: This analyzer is not intended to be used as a safety device.



WARNING: When testing an appliance, a full visual inspection should be performed to ensure its safe operation.



WARNING: This analyzer has not been designed to be intrinsically safe for use in areas classified as being hazardous locations. For your safety, DO NOT use it in hazardous (*classified*) locations.



CAUTION: This analyzer is designed for on-demand and / or semi-continuous sampling and is not intended to be used on a continuous basis.



CAUTION: Do not store instrument or its sensors with solvents or products which contain solvents.



CAUTION: Except for sensor and battery replacement, this analyzer should only be opened and / or serviced by authorized Bacharach personnel. Failure to comply may void the warranty.



CAUTION: When the instrument is used in an inefficient furnace or boiler application where there is a high soot concentration, the probe's sample filter may become clogged. Before every use check the filter to confirm that it is clean or replace it with a new filter.



CAUTION: Never disconnect the probe from the instrument until purging is complete. Otherwise, leftover target gas (*for example, CO*) may remain in the probe and cause inaccurate zeroing at power up that could lead to inaccurate gas measurements afterwards.

1.4 Product Overview

The PCA® 400 is an industrial-grade, hand-held combustion and emissions analyzer for on-demand and / or semi-continuous sampling of commercial and light industrial appliances (*furnaces, boilers and engines*).

Standard Product Configuration

The base instrument is supplied with a probe and hose assembly, factory calibrated / installed sensors, printer interface, hard carry case, filters, USB cable, PC Software (*digital download*), AC adapter and a rechargeable lithium-ion battery pack. The reporting kit version (*in addition to the base*) includes an IrDA + Bluetooth® printer and printer paper.

Intended Product Applications

The intended purpose of the measuring device is for:

- Engineerings servicing / monitoring industrial combustion plants process systems, power stations
- Emissions inspectors, Engine manufacturers and operators, service engineers & mechanics of burner /boiler manufacturers in the industrial sector.

Typical measuring tasks and particular characters of the PCA® 400 include:

- Measurement on industrial engines (*CO / NO dilution*)
- Measurement on gas turbines (*High precision CO and NO plus optional dilution*).
- Emissions measurements (*integrated flow speed and differential pressure measurement*)

The PCA® 400 has not been designed for and SHOULD NOT be used for the following:

- Continuous measurements over 5-hours
- As a safety (*alarm*) instrument.

2. Product Description

| | | |
|-------|--|-----------|
| 2.1 | Combustion & Emissions Analyzer | 10 |
| 2.1.1 | Overview..... | 10 |
| 2.1.2 | Keypad..... | 11 |
| 2.1.3 | Display..... | 11 |
| 2.1.4 | Instrument Connections..... | 13 |
| 2.1.5 | Interfaces | 14 |
| 2.1.6 | Components | 15 |
| 2.2 | Sample Line & Probe Assembly | 16 |
| 2.3 | Power Configurations | 17 |

Fig. 2-1: Product Features

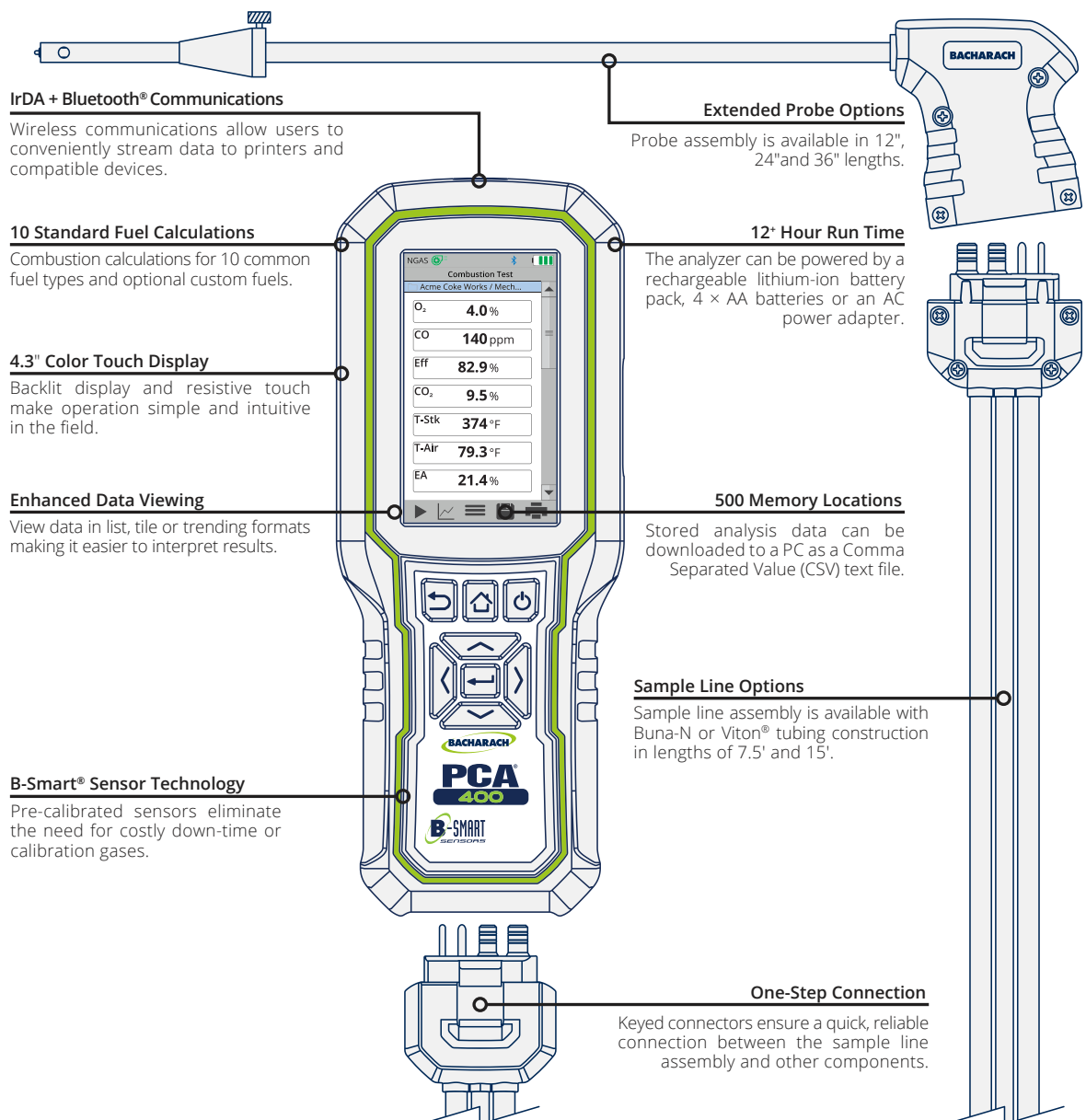

2.1 Combustion & Emissions Analyzer

The PCA® 400 is designed for use in commercial and light industrial applications. The analyzer is capable of measuring O₂, CO, NO, NO₂ or SO₂, stack / ambient temperatures, and pressure. The PCA® 400 also calculates CO₂, NO_x, combustion efficiency and excess air.

2.1.1 Overview

⚠ CAUTION: The analyzer contains strong magnets which may damage other instruments. KEEP AWAY from products which could be damaged by magnetic fields (e.g. monitors, computers, heart pacemakers, credit cards).

Fig. 2-2: Combustion & Emissions Analyzer

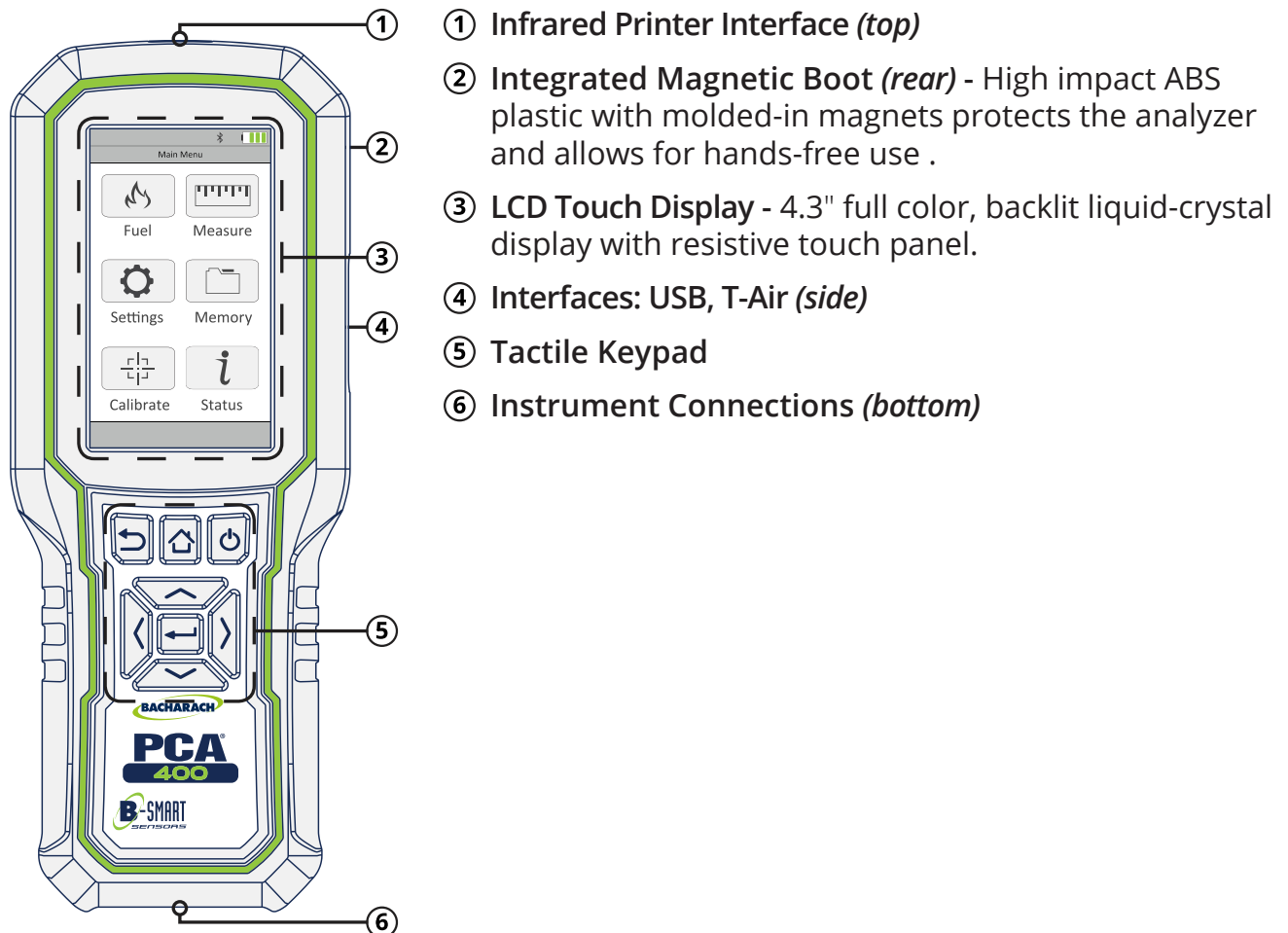

2.1.2 Keypad

Fig. 2-3: Navigation Keypad

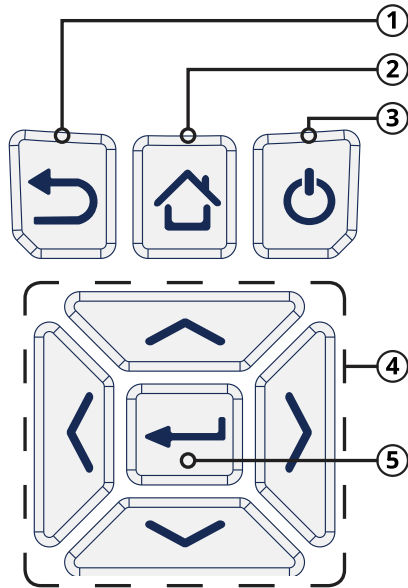

- ① **Back Key** - Displays the previously viewed screen. In addition, if changes have been made to one of the analyzer's operating parameters (e.g., date, time, O₂ reference, etc.), pressing this button aborts any changes, restores the old values and displays the previously viewed screen.
- ② **Home Key** - Displays the Main Menu. In addition, if changes have been made to one of the analyzer's operating parameters (e.g., date, time, O₂ reference, etc.), pressing this button aborts any changes, restores the old values and displays the Main Menu.
- ③ **Power Key** - Turns the analyzer ON and OFF.
- ④ **Navigation Keys** - Move the cursor on the display. When viewing a directory, use the ◀ ▶ buttons to open and close sub-directories.
- ⑤ **Enter Key** - Selects a highlighted item. In addition, if changes have been made to one of the analyzer's operating parameter (e.g., date, time, O₂ reference, etc.), pressing this button confirms those changes and saves them in memory.

2.1.3 Display







! DANGER: Display contains liquid crystal which is poisonous. If liquid crystal comes in contact with skin, wash immediately with soap and water. If ingested, immediately contact the local poison control center.

! CAUTION: DO NOT subject display to excessive shock.









! CAUTION: Periodic cleaning with a lightly moistened soft cloth is recommended. DO NOT wipe display with a dry cloth, as it may scratch the surface.

! CAUTION: DO NOT use organic solvents or detergents to clean the display, as they may cause damage to the screen.

Status Icons

| Icon | Name | Description |
|---|-------------------------------|---|
|  | Pump OFF | Sample pump is idle |
|  | Pump ON | Sample pump is operating |
|  | Battery / Power Status | 100% Charge |
|  | | 75% Charge |
|  | | 50% Charge |
|  | | 25% Charge |
|  | Bluetooth® Active | Bluetooth® is enabled and compatible devices may be connected |

Preference Icons

| Icon | Name | Description |
|---|------------------------|---|
|  | Display Options | Display table / list format |
|  | | Display trending / line graph format |
|  | | Display tile format |
|  | Settings | Display configuration parameters |
|  | Memory | Set file structure and naming conventions for data storage |
|  | Fuel Types | Display list from which to select current test's combustion fuel |
|  | Status | Display device status, device information and main diagnostics |
|  | Options | Context-sensitive parameters; touch to adjust run/hold format, low / high limits, features, options, etc. |

Function Icons

| Icon | Name | Description |
|------|---------------------|--|
| | Measure | Touch to select test to perform (<i>combustion, pressure, temperature</i>) |
| | Turn On Pump | Touch to turn on pump; used with II to toggle RUN / HOLD mode |
| | Stop Pump | Touch to stop pump; used with ► to toggle RUN / HOLD mode |
| | Print | Touch to print data to IrDA + Bluetooth® printer |
| | Save | Touch to save data to default selected folder |
| | Calibrate | Touch to perform calibration functions |

2.1.4 Instrument Connections

Fig. 2-4: Sample Line Connection Port

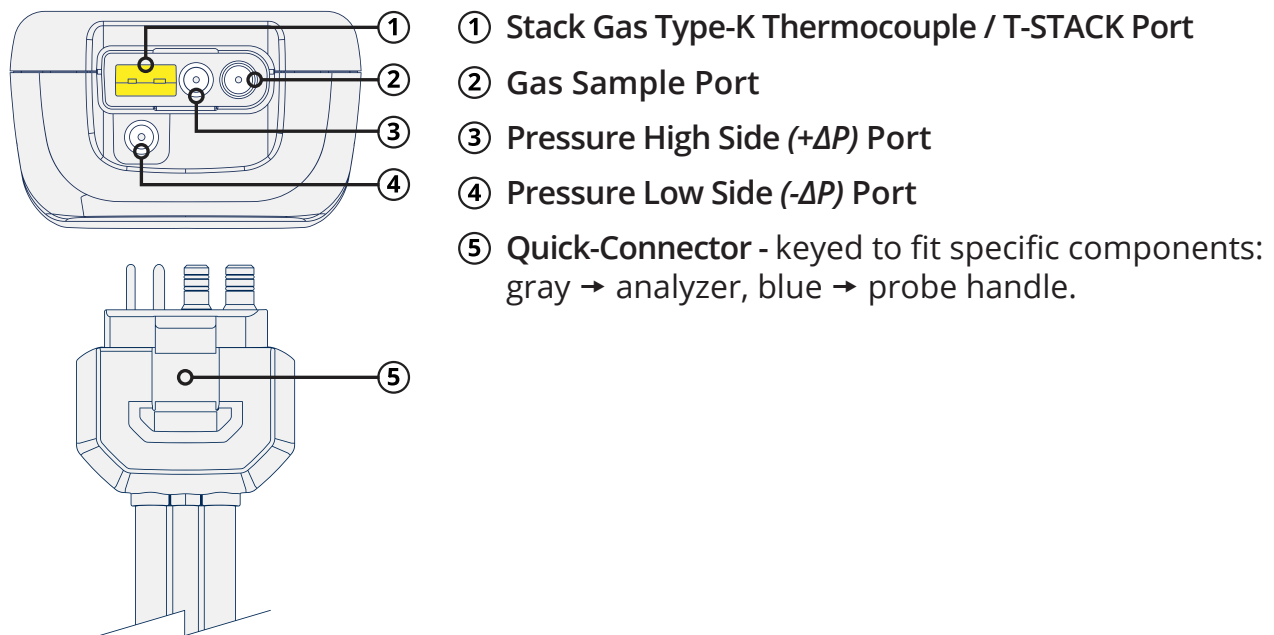

2.1.5 Interfaces

Computer Interface

Data that has been stored in the analyzer's onboard memory can be uploaded to a personal computer by connecting the included Micro-B USB Cable between the USB ports of the computer and the analyzer.

Fig. 2-5: Micro-B USB Port

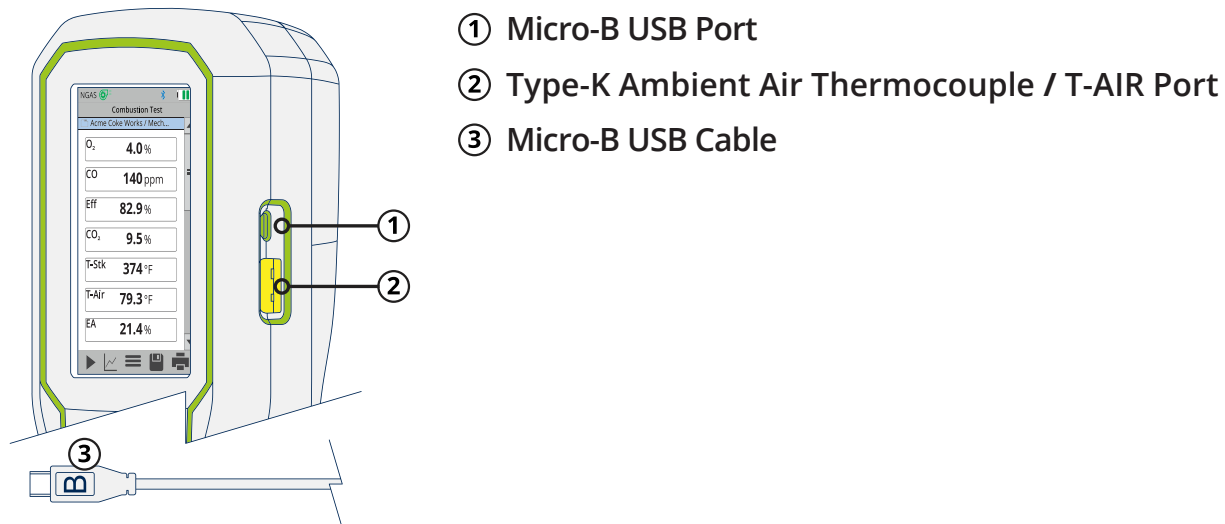

Printer Interfaces

The PCA® 400 is capable of wirelessly transmitting data to compatible IrDA (*Infrared Data Associated*) or IrDA + Bluetooth® Printers. The IrDA Interface is located at the top of the device (*Figure 2-2*).



IMPORTANT: Interference can be caused by devices that are transmitting on the same frequency band.



WARNING: Use of radio connection may not be permitted in some locations (*e.g. airplanes, hospitals*). User assumes responsibility for complying with rules governing the use of radio connections.

Fig. 2-6: IrDA Communication Range

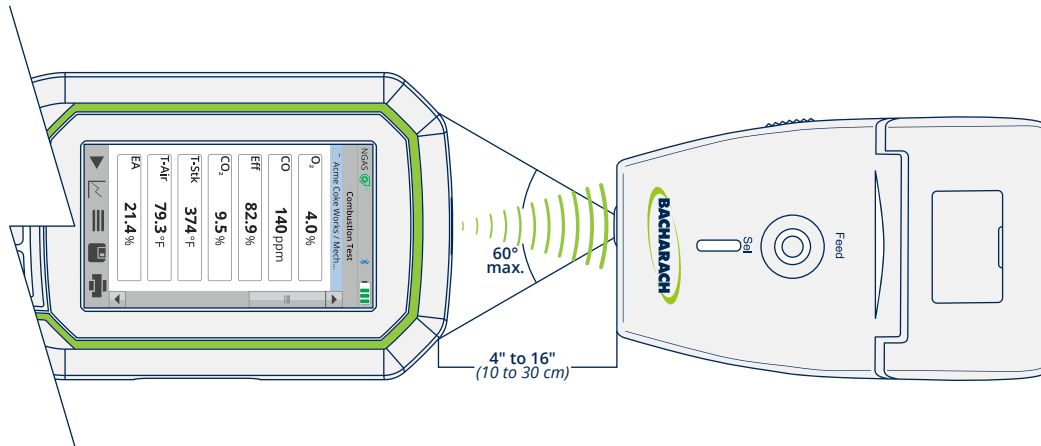
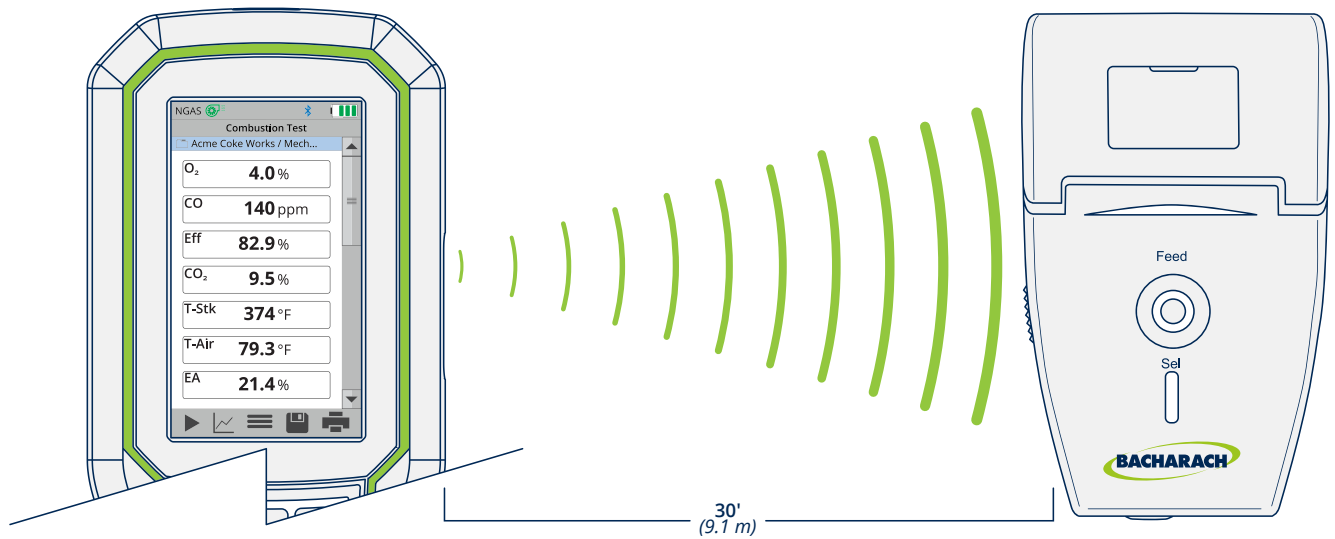

Fig. 2-7: Bluetooth® Communication Range



2.1.6 Components



CAUTION: Except for sensor and battery replacement, this analyzer should only be opened and / or serviced by authorized Bacharach personnel. Failure to comply may void the warranty.

Fig. 2-8: Sensor & Battery Positions

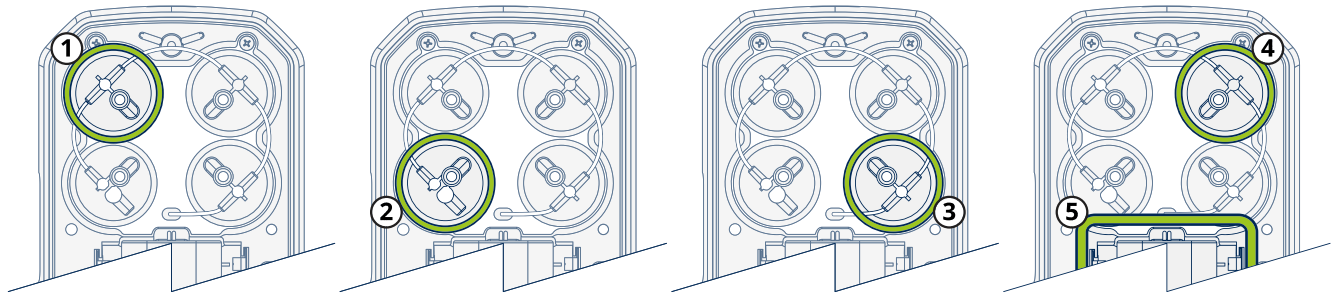

- ① Sensor Position 1 - O₂
- ② Sensor Position 2 - CO_{LOW} or CO_{HIGH}
- ③ Sensor Position 3 - NO₂ or SO₂
- ④ Sensor Position 4 - NO
- ⑤ Battery Compartment

2.2 Sample Line & Probe Assembly

The PCA® 400's sample line and probe are modular, allowing users to quickly swap out different sized probe lengths, sample lines and the optional sample conditioner.

Fig. 2-9: Sample Line & Probe Assembly

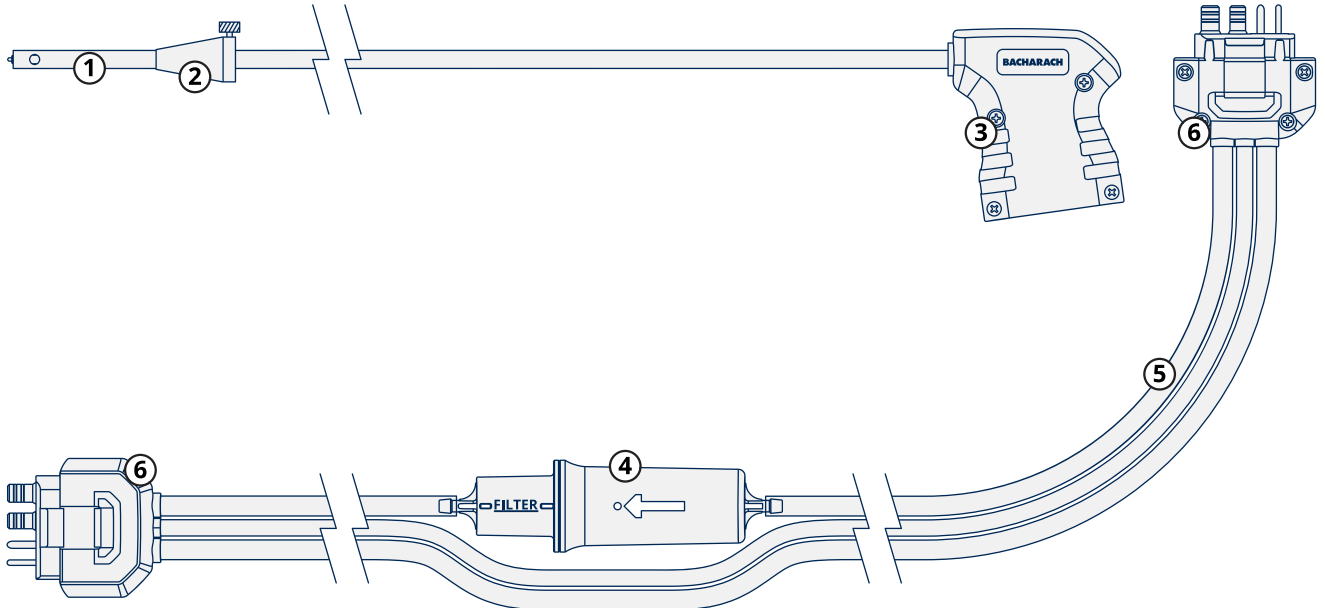

- ① Probe Tube - available in multiple lengths.
- ② Probe Stop
- ③ Probe Handle
- ④ Water Trap / Filter Assembly
- ⑤ Sample Line - available in multiple lengths and construction types.
- ⑥ Quick-Connector - keyed to fit specific components: gray → analyzer, blue → probe handle.



IMPORTANT: Replacement parts and accessories are sold separately. See Part Numbers (Section 7.1) for more information.

2.3 Power Configurations

The PCA® 400 comes standard with a rechargeable lithium-ion battery pack which is capable of powering the analyzer for up to 12-hours. Users may also run the analyzer on 4 × AA batteries or via the supplied Micro-B USB cable and AC power adapter.



WARNING: DO NOT disassemble battery pack or short battery contacts, as this may result in electrical shock.



DANGER: Batteries may pose risk of explosion, fire or chemical burns if mistreated:

- *NEVER* dispose of batteries in a fire or incinerator.
- *NEVER* expose batteries to corrosive liquids.
- *DO NOT* attempt to charge batteries which are swollen or bulging.



CAUTION: Lithium-Ion batteries contain elements that may pose health risks to individuals if they are allowed to leach into the ground water supply. Always dispose of batteries in accordance with local regulations.



IMPORTANT: Operating the analyzer with the AC power adapter DOES NOT charge its rechargeable batteries. To recharge the analyzer's batteries, supply power via the AC power adapter when the analyzer is turned OFF.

Fig. 2-10: Configurations for Li-ion Battery Pack and 4 × AA Batteries

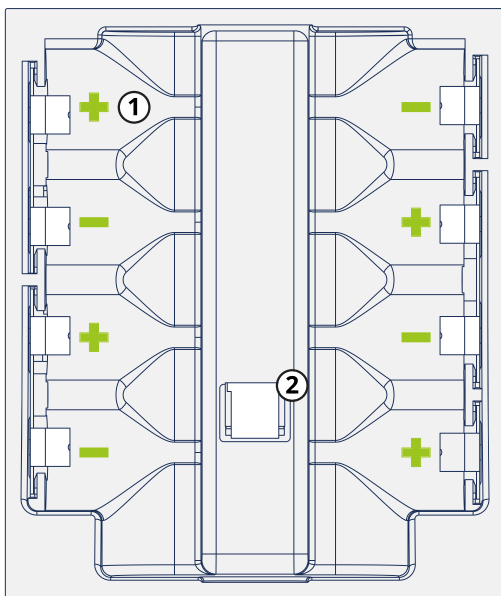

① AA Battery Tray

② Li-ion Battery Pack Connection

3. Operation

| | | |
|-------|-----------------------------------|----|
| 3.1 | Setup | 18 |
| 3.1.1 | Operation Tips..... | 18 |
| 3.1.2 | Inspection / Prerequisites..... | 20 |
| 3.1.3 | Connecting Probe Assembly..... | 21 |
| 3.2 | Performing Combustion Test | 22 |
| 3.2.1 | Combustion User Preferences | 22 |
| 3.2.2 | Combustion Analysis | 23 |
| 3.2.3 | Additional Settings | 25 |
| 3.3 | Performing Pressure Test | 28 |
| 3.3.1 | Pressure User Preferences | 28 |
| 3.3.2 | Pressure Analysis..... | 28 |
| 3.4 | Performing Temperature Test | 30 |
| 3.4.1 | Temperature User Preferences..... | 30 |
| 3.4.2 | Temperature Analysis..... | 30 |

3.1 Setup

Properly preparing the analyzer is critical to accurate analysis and safe operation. Be sure to read the following instructions prior to use of this instrument.

3.1.1 Operation Tips

Allow Analyzer to Warm-up Slowly

When an analyzer is brought in from a cold vehicle, allow it to warm-up slowly to minimize condensation. Temperatures below freezing will not damage the analyzer.



CAUTION: Although the analyzer itself is not damaged by extremely cold temperatures, the electrochemical sensors may sustain damage. The O₂ sensor's electrolyte will freeze at approximately -13°F (-25°C), and the other sensors at approximately -94°F (-70°C). If the analyzer is exposed to extremely cold conditions, it is strongly suggested that the sensor housings be examined for hairline cracks. Be aware that a leaking sensor can cause chemical burns to the skin and possibly damage the surrounding PCB assemblies.

Start Analyzer in Fresh Air

Ensure that the analyzer is sampling fresh air during initial 60-second warm-up period. Pulling a stack gas sample through the analyzer during its warm-up period will not damage the analyzer, but it will result in incorrect sensor readings, and may result in sensor error messages appearing after the warm-up cycle completes.

Inspect Water Trap / Filter Assembly

Before each use, inspect the filter element of the water trap / filter assembly. Replace the filter if it looks dirty. See Replacing the Filter Element (*Section 5.2*) for more information.

Keep Analyzer Above Water Trap Assembly

When sampling flue gas, keep the analyzer above the water trap, and keep the trap in a vertical position. This will maximize the effectiveness of the trap and keep liquid condensate from being drawn directly into the analyzer. (*Flue gas condensate can be acidic and very corrosive. Do not to allow the analyzer's internal components to come in contact with condensate.*)

Don't Allow Water Trap to Become Full

When liquid condensate is seen inside the water trap, empty the trap before it becomes full. See Emptying the Water Trap (*Section 5.1*) for more information.

Fig. 3-1: Water Trap / Filter Assembly

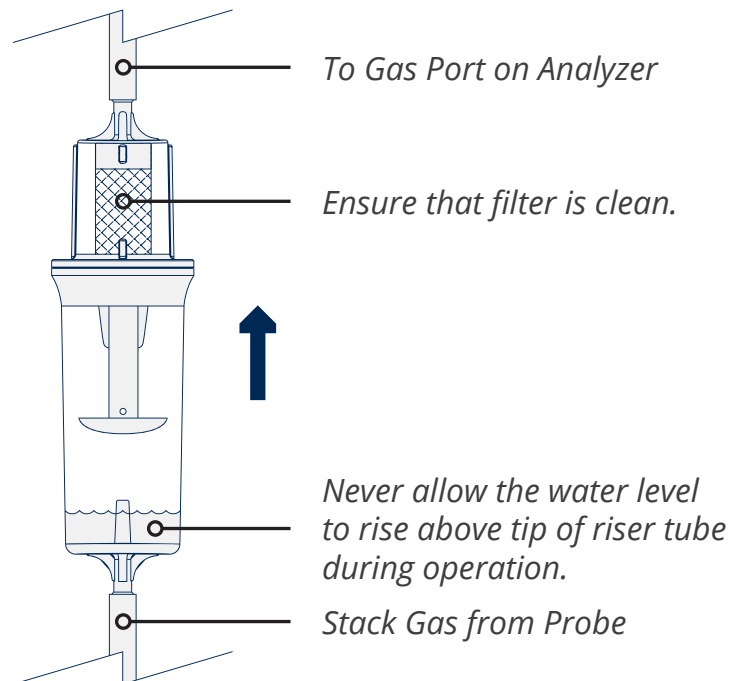

CAUTION: Use the Water Trap / Filter Assembly in a vertical position with the gas flow arrow pointing up as shown in the illustration above.

Purge Analyzer After Each Use

The analyzer should be purged after performing a combustion test. After removing probe from the stack, let the pump run for at least 10-minutes to remove any stack gases and dry any condensate from inside the sensor chamber and probe assembly.

Remove Moisture from Water Trap Before Storing

When storing the analyzer, it is recommended that users empty the water trap and leave it open to prevent damage associated with prolonged exposure to moisture. See Emptying the Water Trap (*Section 5.1*) for more information.

Maintain Sensor Calibration

Calibrate the analyzer every 6-months to 1-year to ensure its accuracy. See Calibration (*Sections 5.5 and 5.6*) for more information.

3.1.2 Inspection / Prerequisites

Before performing any tests with the analyzer, verify the following:

- The water trap / filter assembly is empty, clean, and the arrow is pointing UP.
- Check for obvious signs of splits and or cracks in the sample line and other tubing.
- Perform routine maintenance (*replacing sensors, calibrating, etc.*) as outlined in Care & Maintenance.
- Ensure that the analyzer has sufficient charge before operation. If in doubt, recharge Li-ion battery pack, replace disposable batteries or provide power via the AC adapter and USB cable.

Fig. 3-2: Acceptable Battery Levels

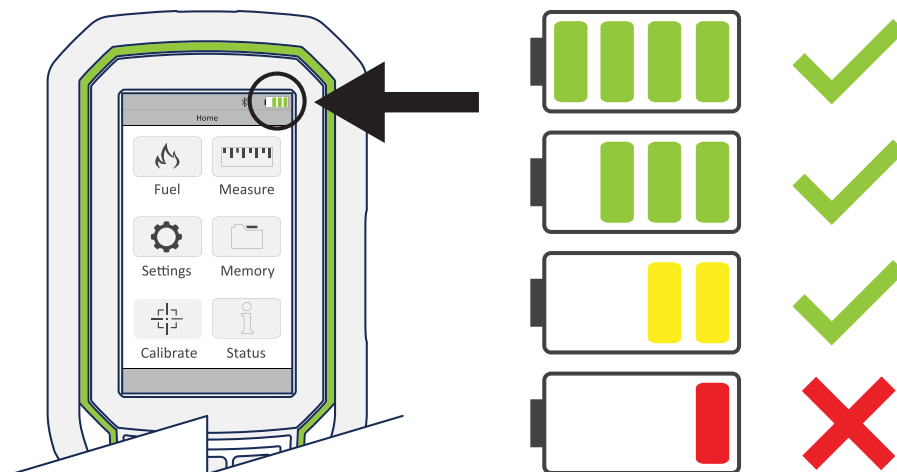

3.1.3 Connecting Probe Assembly

1. Connect Analyzer to Sample Line

Firmly insert the gray quick-connector into the base of the analyzer. Users will hear a click once a secure connection has been made.

Fig. 3-3: Insert Gray Quick-Connector into Analyzer

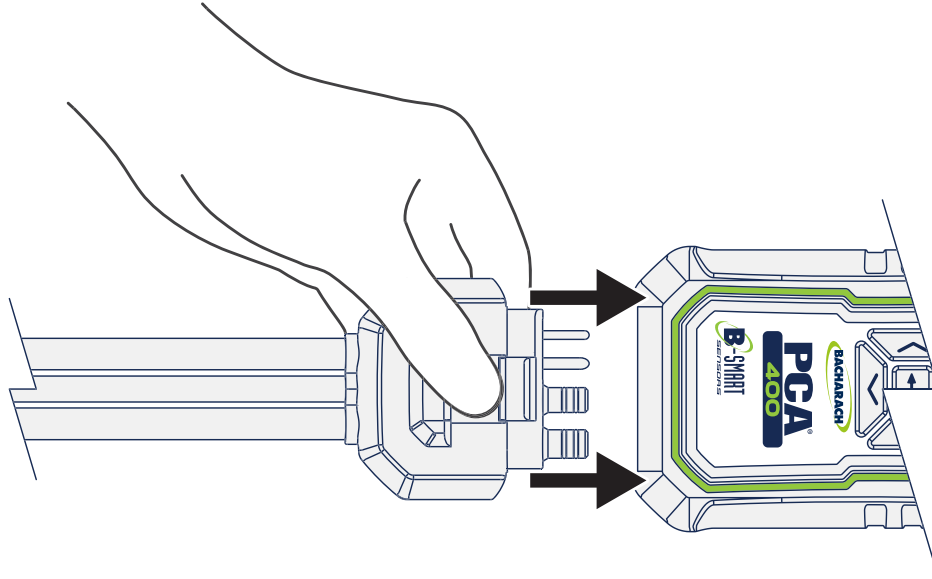

2. Connect Probe to Sample Line

Firmly insert the blue quick-connector into the base of the probe handle. Users will hear a click once a secure connection has been made.

Fig. 3-4: Insert Blue Quick-Connector into Probe Handle

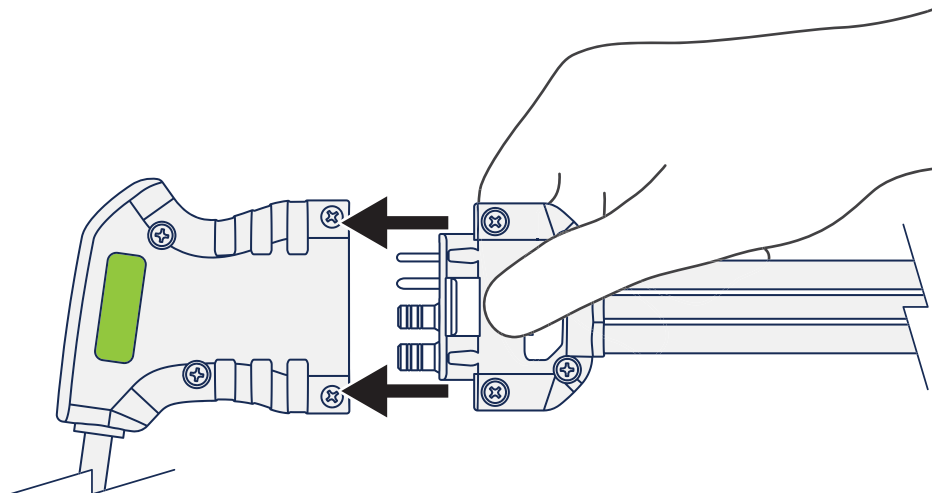

3. Turn On Analyzer

Press the POWER button to begin a 60-second warm-up period. Users will hear the pump begin operation and splash screen should appear on the analyzer's display.

Fig. 3-5: Press Power Button



CAUTION: Ensure that the analyzer is sampling fresh air during the warm-up. Pulling a stack gas sample through the analyzer during its warm-up period will not damage the analyzer, but it will result in incorrect sensor readings, and may result in sensor error messages appearing after the warm-up cycle completes.

3.2 Performing Combustion Test

3.2.1 Combustion User Preferences

Temperature Units

Select to display temperature in Fahrenheit (°F) or Celsius (°C).

- ▶ To change Temperature Units: **Main Menu** → **Settings** (⊗) → **Temperature Units** → select **Fahrenheit** or **Celsius**

Pollution Units

The PCA® 400 is capable of converting the measured ppm levels of CO, NO, NO₂, and SO₂ to various pollution units using CFR40 Part 60 emission factors. (Note that the pollution unit conversions for NO, NO₂ and NO_x are based on the molecular weight of NO₂.)

- ▶ To change Pollution Units: **Main Menu** → **Settings** (⊗) → **Pollution Units** → select **ppm, lb/MBtu, mg/m³** or **g/GJ**



IMPORTANT: After saving changes to Temperature and Pollution Units, they will become the analyzer's default values for all future testing.

3.2.2 Combustion Analysis

1. Select Folder / Memory Location (*User Discretion*)

The PCA® 400 gives users the ability to organize their records in a folder structure for later viewing and downloads.

- ▶ To change Folder / Memory Location: *Main Menu* → *Memory* (☐) → use navigation keys to highlight the desired folder → *Options* (≡) → select *Target*

2. Select Fuel Type

- ▶ To select Fuel Type: *Main Menu* → *Fuel Menu* (⚙) → select *Natural Gas (NGAS)*, *Oil #2 (OIL2)*, *Oil #4 (OIL4)*, *Oil #6 (OIL6)*, *Propane (PROP)*, *Coal (COAL)*, *Wood (WOOD)*, *Kerosene (KERO)*, *Bagasse (BAG)*, or *Digester Gas (DGAS)*

3. Select Measurement Type

- ▶ To select Measurement Type: *Main Menu* → *Measure* (⚖) → select *Combustion*

4. Insert Probe Tube into Measurement Area

After identifying the flue / exhaust stack, select a safe and convenient location from which to draw the sample.

- ▶ Select length-appropriate probe
- ▶ Set probe stop to ensure that the probe is inserted into the center of the flue / exhaust stack / measurement area (*The probe stop also acts to secure the probe in the measurement area during analysis.*)

Fig. 3-6: Probe Placed in Center of Measurement Area



CAUTION: When the instrument is used in an inefficient furnace or boiler application where there is a high soot concentration, the probe's sample filter may become clogged. Before every use check the filter to confirm that it is clean or replace it with a new filter (*Section 5.2*).

5. Run Sample Pump

After starting the pump, allow readings to stabilize for a minimum of 3-minutes or as long as required by manufacturer specifications / compliance testing procedures.

- ▶ To start the pump: press *Run / Hold* (▶)
- ▶ To stop the pump: press *Run / Hold* (||)

Fig. 3-7: Combustion Test Screen

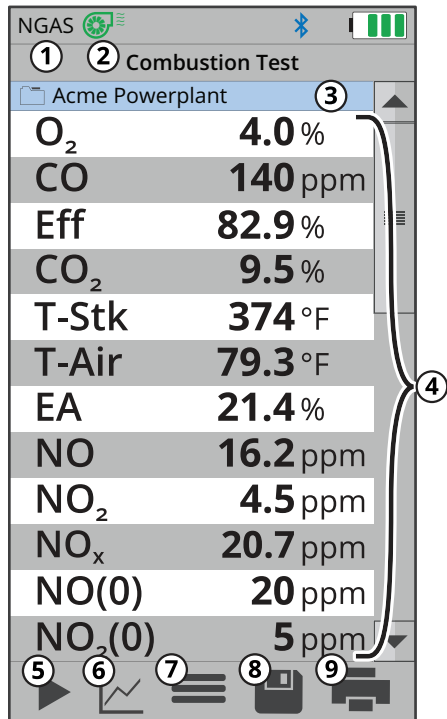

- ① **Fuel Type** - displays fuel calculation being used to produce combustion data.
- ② **Pump Status** - (⊕) indicates that the pump is on, (⊖) indicates that the pump is off.
- ③ **Folder / Memory Location** - location where combustion data will be saved.
- ④ **Combustion Data** - results from combustion analysis; display can be toggled by pressing (⌵).
- ⑤ **Run / Hold** - toggle sample pump operation; press (▶) to run and (||) to pause.
- ⑥ **Toggle View** - change data display between table / list (≡), line graph (⌵), tile (■) formats.
- ⑦ **Options** - displays additional settings / configuration (*Fresh Air Purge, Logging, Pump Speed, Run / Hold Format, Line Graph Settings, O₂ Reference, Zoom, NO_x Calculation*).
- ⑧ **Save** - save combustion data to the selected folder / memory location.
- ⑨ **Print** - print combustion data to IrDA / Bluetooth® printer(s).

6. Save / Print Readings

The PCA® 400 is capable of saving active data to the analyzer's onboard storage and / or printing to the optional IrDA / Bluetooth® printer.

- ▶ To save combustion readings / report: press Save (💾)
- ▶ To print combustion readings / report: press Print (🖨️)



IMPORTANT: Printing via Bluetooth® is disabled when the analyzer is connected to the PCA® 400 App. If you wish to print, disconnect from the mobile app or enable IrDA communications.



CAUTION: The probe MAY BE HOT after analysis and can cause bodily harm and / or damage to the analyzer. Allow the probe sufficient time (*about 5-minutes*) to cool before handling or storing in the supplied carrying case.



CAUTION: Never disconnect the probe from the instrument until purging is complete. Otherwise, leftover target gas (*for example, CO*) may remain in the probe and cause inaccurate zeroing at power up that could lead to inaccurate gas measurements afterwards.



CAUTION: The probe and sample line may become dirty during normal use and should be cleaned regularly to ensure proper function. See *Cleaning the Probe Assembly (Section 5.3)* for more information.

3.2.3 Additional Settings

Data Display Options

Data can be viewed in list (*text*), tile and trending formats allowing users to easily analyze their combustion analysis results. Users can further customize the PCA® 400 to show all the parameters in the order they prefer.

- ▶ To toggle between Display Options: *Display Options* (⌵) → select *Table / List Format* (≡), *Line Graph Format* (⌵) or *Tile Format* (■)

Fig. 3-8: Table / List, Line Graph and Tile Formats

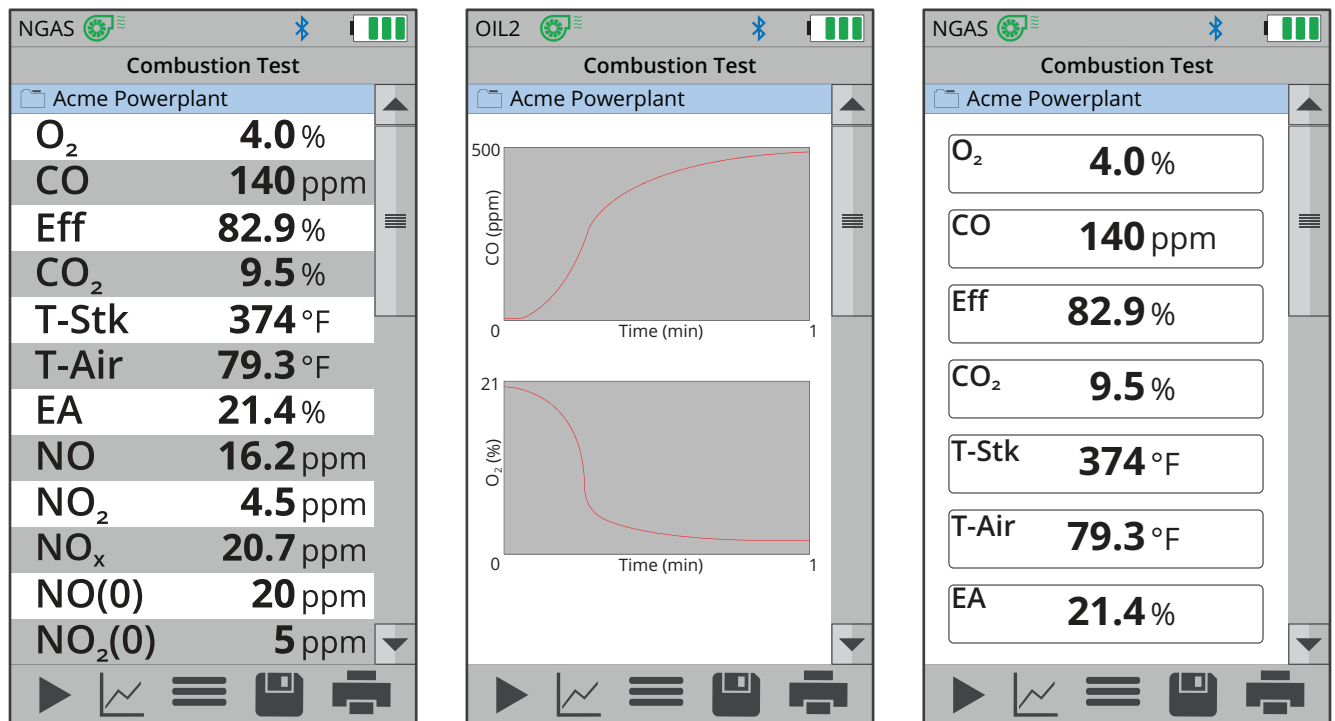

Run / Hold Format (List View)

The analyzer allows users to customize the order in which analysis results are displayed.

- ▶ To update Run / Hold Format: **Options** (≡) → **Run / Hold Format** → set prioritization via dropdown menu → press **Save** (💾)

Fig. 3-9: Run / Hold Format

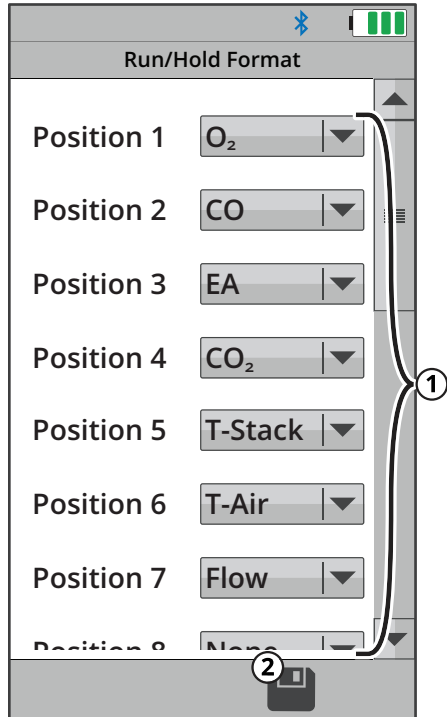

- ① **Analysis Positions** - use the dropdown menu to customize the order in which analysis results are displayed in the List View.
- ② **Save** - save Run / Hold Format and return to current combustion analysis results.

Zoom (List View)

Combustion test data can be shown with enlarged characters to make viewing easier. The operator can set zoom levels to STANDARD or LARGE. The Standard zoom setting will display fifteen (15) lines of combustion test data at one time and the Large zoom setting will display twelve (12) lines of combustion test data with enlarged characters. The operator can scroll through the complete list of measured and calculated data no matter what zoom level has been selected.

- ▶ To update Zoom: **Options** (≡) → **Zoom** → select *Standard* or *Large*

Line Graph Settings (Trending View)

The analyzer allows users to customize the order in which analysis results are displayed.

- ▶ To update Line Graph Settings: *Options* (☰) → *Line Graph Settings* → set parameters & time via dropdown menu → press *Save* (💾)

Fig. 3-10: Line Graph Settings

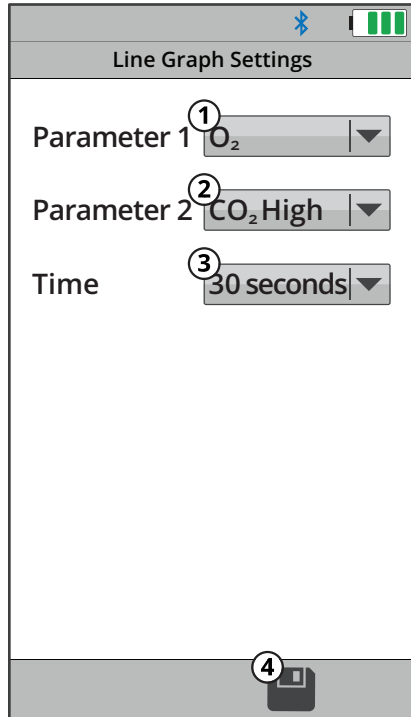

- ① **Parameter 1** - value of the top graph's y-axis; choose from None, O₂, CO, NO, NO₂, SO₂, T-AIR, T-STK, Eff, EA, CO₂, NO_x, CO(0), NO (0), NO₂(0), NO_x(0) or SO₂(0).
- ② **Parameter 2** - value of the bottom graph's y-axis; choose from None, O₂, CO, NO, NO₂, SO₂, T-AIR, T-STK, Eff, EA, CO₂, NO_x, CO(0), NO (0), NO₂(0), NO_x(0) or SO₂(0).
- ③ **Time** - value of the each graph's x-axis; choose from 30-seconds, 1-minute, 3-minutes, 5-minutes and 15-minutes.
- ④ **Save** - save Line Graph Settings and return to current combustion analysis results.

Pump Speed

The sample pump is capable of operating at two different rates; allowing users to compensate for longer lengths of sample line or to overcome higher draft in the measurement area.

- ▶ To change Pump Speed: *Options* (☰) → *Pump Speed* → select *Standard* or *High*

i **IMPORTANT:** Operating the analyzer at a higher pump rate consumes more power and will reduce the expected battery life.

i **IMPORTANT:** Changes to this setting will not become the analyzer's default value for future testing. When restarting, the analyzer will revert to STANDARD pump rate.

3.3 Performing Pressure Test

3.3.1 Pressure User Preferences

Pressure Units

Select to display pressure in Inches of Water Column (*inwc*), Millibar (*mB*), Pascal (*Pa*), Hecto-Pascal (*hPa*) or Millimeters of Water Column (*mmwc*).

- ▶ To change Pressure Units: *Main Menu* → *Settings* (⚙) → *Pressure Units* → select *InchesWater*, *milliBar*, *Pascals*, *HectoPascals* or *mmH₂O*

3.3.2 Pressure Analysis

1. Select Folder / Memory Location (*User Discretion*)

The PCA® 400 gives users the ability to organize their records in a folder structure for later viewing and downloads.

- ▶ To change Folder / Memory Location: *Main Menu* → *Memory* (📁) → use navigation keys to highlight the desired folder → *Options* (≡) → select *Target*

2. Select Measurement Type

- ▶ To select Measurement Type: *Main Menu* → *Measure* (📏) → select *Pressure*

3. Zero Pressure Sensor (*User Discretion*)

Before taking a measurement, the pressure sensor may need to be re-zeroed if it is not already displaying zero with both pressure ports open to the atmosphere.

- ▶ If necessary, zero the pressure sensor: Press *Zero* (0).
- ▶ Disconnect hoses and press *OK* to zero the pressure sensor.
- ▶ Reconnect hoses. When measuring draft, leave the $-\Delta P$ port open to the atmosphere and connect the probe's draft hose to the $+\Delta P$ port.

Fig. 3-11: Pressure Connection Ports

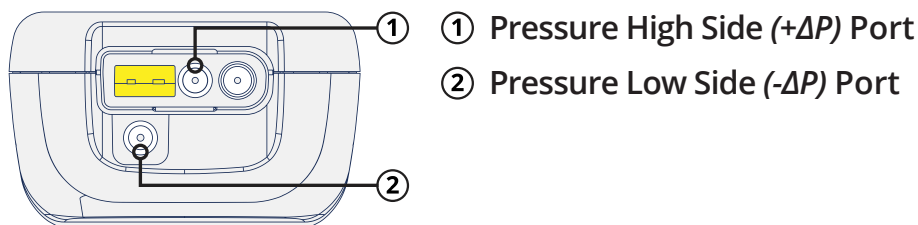

4. Insert Probe Tube into Measurement Area

After identifying the flue / exhaust stack, select a safe and convenient location from which to take measurements.

- ▶ To measure draft: insert the probe tube into the flue / exhaust stack / measurement area and observe the reading on the Pressure screen.
- ▶ To measure differential pressure: connect sampling hoses to the + ΔP and - ΔP ports and place the ends of the hoses into the measurement areas being compared. The differential pressure between the two areas will be displayed on the Pressure screen. The differential pressure reading will be positive if the pressure at the + ΔP is higher than that read at the - ΔP and negative if it is lower than that read at the - ΔP .

Fig. 3-12: Pressure Test Screen

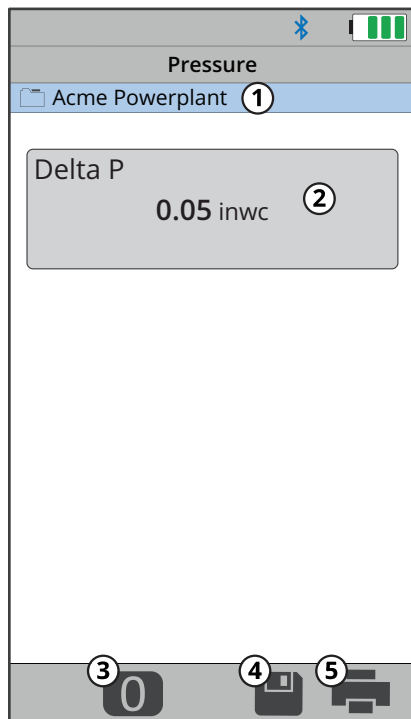

- ① **Selected Folder / Memory Location** - location where data will be saved.
- ② **Differential Pressure** - measured difference between Pressure High Side (+ ΔP) and Pressure Low Side (- ΔP).
- ③ **Zero Button** - press to zero (calibrate) pressure reading to ambient pressure.
- ④ **Save** - save pressure data to the selected folder / memory location.
- ⑤ **Print** - print pressure data to IrDA / Bluetooth® printer(s).

5. Save / Print Readings

The PCA® 400 is capable of saving active data to the analyzer's onboard storage and / or printing to the optional IrDA / Bluetooth® printer.

- ▶ To save pressure readings / report: press **Save** (📁)
- ▶ To print pressure readings / report: press **Print** (🖨️)



IMPORTANT: Printing via Bluetooth® is disabled when the analyzer is connected to the PCA® 400 App. If you wish to print, disconnect from the mobile app or enable IrDA communications.

3.4 Performing Temperature Test

3.4.1 Temperature User Preferences

Temperature Units

Select to display temperature in Fahrenheit (°F) or Celsius (°C).

- ▶ To change Temperature Units: *Main Menu* → *Settings* (⚙) → *Temperature Units* → select *Fahrenheit* or *Celsius*

3.4.2 Temperature Analysis

1. Select Folder / Memory Location (*User Discretion*)

The PCA® 400 gives users the ability to organize their records in a folder structure for later viewing and downloads.

- ▶ To change Folder / Memory Location: *Main Menu* → *Memory* (📁) → use navigation keys to highlight the desired folder → *Options* (☰) → select *Target*

2. Install Thermocouple

Plug Type-K Thermocouple into the T-AIR Port on the side of the analyzer.

Fig. 3-13: Ambient Air Thermocouple Port

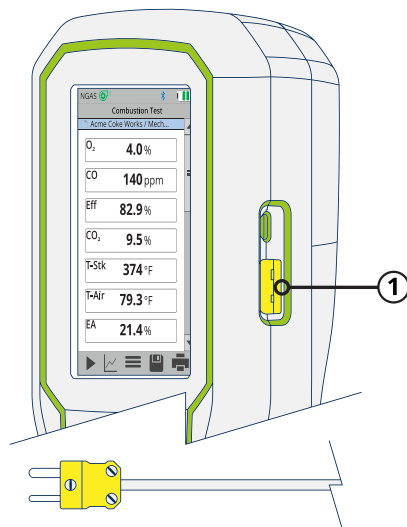

① Type-K Ambient Air Thermocouple / T-AIR Port

3. Select Measurement Type

▶ To select Measurement Type: *Main Menu* → *Measure* (☰) → select *Temperature*

4. Zero Readings

If the analyzer is not displaying zero with both thermocouples exposed to the same conditions, the temperature channels need to be zeroed

5. Insert Thermocouples into Measurement Areas

Fig. 3-14: Temperature Test Screen

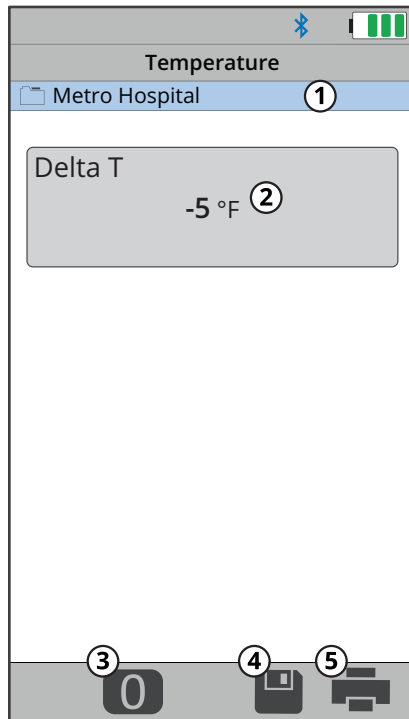

- ① Selected Folder / Memory Location - location where data will be saved.
- ② Calculated Temperature Differential - calculated difference between the measured T1 and T2.
- ③ Zero Button - press to zero (*calibrate*) temperature reading in ambient temperature.
- ④ Save - save temperature data to the selected folder / memory location.
- ⑤ Print - print temperature data to IrDA / Bluetooth® printer(s).

6. Save / Print Readings

The PCA® 400 is capable of saving active data to the analyzer's onboard storage and / or printing to the optional IrDA / Bluetooth® printer.

- ▶ To save temperature readings / report: press *Save* (📁)
- ▶ To print temperature readings / report: press *Print* (🖨️)



IMPORTANT: Printing via Bluetooth® is disabled when the analyzer is connected to the PCA® 400 App. If you wish to print, disconnect from the mobile app or enable IrDA communications.

4. Settings & Features

| | | |
|------|--|----|
| 4.1 | Language Selection..... | 32 |
| 4.2 | Date & Time..... | 32 |
| 4.3 | Username | 33 |
| 4.4 | Button Sound | 34 |
| 4.5 | Inactivity Timeout..... | 34 |
| 4.6 | Post-Purge Period | 34 |
| 4.7 | Carbon Monoxide (CO) Zero | 34 |
| 4.8 | Sensor Setup..... | 35 |
| 4.9 | Bluetooth® Setup | 36 |
| 4.10 | Printer Setup | 37 |
| 4.11 | Onboard Data Logging | 38 |
| 4.12 | Memory File Management..... | 39 |
| 4.13 | Fresh Air Purge without Removing Probe | 40 |
| 4.14 | Sensor Protection / Dilution Mode | 41 |

4.1 Language Selection

North American versions of the PCA® 400 will display information in English, French, and Spanish. Languages are chosen through software menu selections.

Changing Language Preference

- ▶ To change Language Selection: *Main Menu* → *Settings* (⊙) → *Language* → select *English*, *Français* or *Español*

4.2 Date & Time

The instrument has the ability to store, recall to display, and print 500 sets of time and date coded test records. (By default, the date is stored in the format: MM/DD/YY. Time is stored in the format: hh:mm:ss AM/PM.) Date & Time are set through software menu selections.

Changing Date / Time

- ▶ To change Date & Time of analyzer's internal clock: *Main Menu* → *Settings* (⊙) → *Time and Date* → update date and time → press *Save* (⏏)

Fig. 4-1: Date and Time Menu

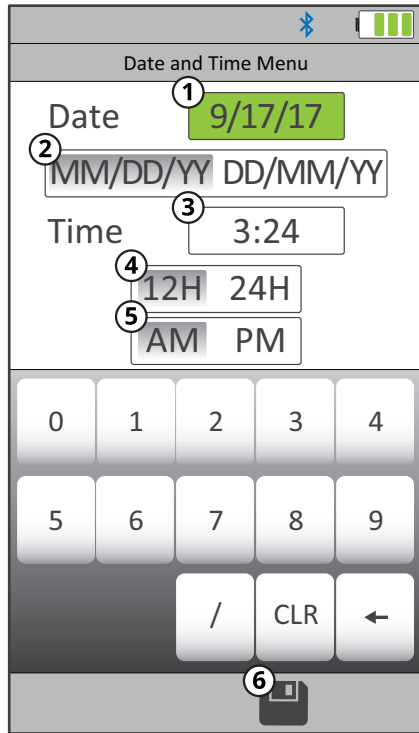

- ① **Date** - change date (*must delete / clear current date before you can add new date*).
- ② **Date Format** - change between month / day / year and day / month / year calendar formats.
- ③ **Time** - change time (*must delete / clear current time before you can add new time*).
- ④ **Time Format** - change between 12 and 24-hour time formats.
- ⑤ **AM / PM** - if 12-hour format is selected, select AM or PM.
- ⑥ **Save** - save changes to Date and Time and return to the Settings menu.

4.3 Username

The Username is typically the analyzer's primary user or owner (*e.g., company name, address, phone number*) and can be stored in memory by manually entering up to three lines of text, with each line containing up to 18 alphanumeric characters.

Entering / Editing Username

- ▶ To change the analyzer's Username: *Main Menu* → *Settings* (⊙) → *Username* → use keyboard to input username → press *Save* (⏎)



IMPORTANT: Username information will appear at the top of each printout (*Figure 4-4*) until new information is entered or cleared.

4.4 Button Sound

The analyzer includes a sound transducer which beeps to signal when a button has been pressed. The audible notification can be turned OFF and ON by changing the user preferences.

Enabling / Disabling Button Sound

- ▶ To enable / disable Button Sound: *Main Menu* → *Settings* (⊗) → *Button Sound* → select *No* or *Yes*

4.5 Inactivity Timeout

When enabled, the Inactivity Timeout feature will cause the analyzer to POWER DOWN if no touch screen or keypad activity occurs within the selected duration.

Enabling / Disabling Inactivity Timeout

- ▶ To change the inactivity timeout settings: *Main Menu* → *Settings* (⊗) → *Inactivity Timeout* → select *None*, *20-minutes*, *30-minutes* or *60-minutes*

4.6 Post-Purge Period

Purge feature at shutdown; if enabled, specifies a duration time (*None*, *1*, *5*, or *10 minutes*) during which the analyzer's pump will remain on in order to purge gases from the analyzer and probe after a shutdown request has been initiated.

Enabling / Disabling Post-Purge Period

- ▶ To change the Post-Purge Period settings: *Main Menu* → *Settings* (⊗) → *Post-Purge Period* → select *None*, *1-minute*, *5-minutes* or *10-minutes*

4.7 Carbon Monoxide (CO) Zero

Configures the analyzer's CO zeroing process to be done either manually or automatically.

Manual Zero

When the CO channel is set to Manual Zero, the analyzer does not zero the CO sensor to ambient conditions during start up. In this mode, the "fresh air zero" established during manual mode setup is stored in memory and used for the measurement of CO.

Auto-Zero

When the CO channel is set to Auto-Zero, the CO sensor is zeroed to the ambient CO level during start up.

Changing CO Zero Method

Auto-Zero determines the zero reading of the CO channel in fresh air and provides an offset for the CO measurements. Manual Zero is used to detect CO that may be present during start-up. The Auto / Manual Zeroing option allows the operator to select the start-up mode.

- ▶ To change the CO Zero settings: *Main Menu* → *Settings* (⊗) → *CO Zero* → select *Auto-Zero* or *Manual Zero*

i **IMPORTANT:** Both methods for zeroing CO require that the analyzer be turned ON in fresh air; otherwise, incorrect CO readings will occur.

i **IMPORTANT:** The PCA® 400 performs a zero function during warm-up. Among other purposes, an auto-zero determines the “zero reading” of the CO channel in fresh air and provides an offset for the CO measurement. A manual zero detects background CO during startup.

i **IMPORTANT:** Both methods take the user through a 60-second count down to establish a new zero. The manual mode establishes a fresh air zero and stores it for use during instrument warm-up.

4.8 Sensor Setup

The PCA® 400 is designed to allow sensors to be interchanged in the field; allowing users to perform combustion tests for multiple gases with the same analyzer.

Changing Sensor Setup

- ▶ To change Sensor Setup: *Main Menu* → *Settings* (⊗) → *Sensor Setup* → select desired sensor from dropdown menus → press *Save* (⏏)

Fig. 4-2: Gas Sensor Positions

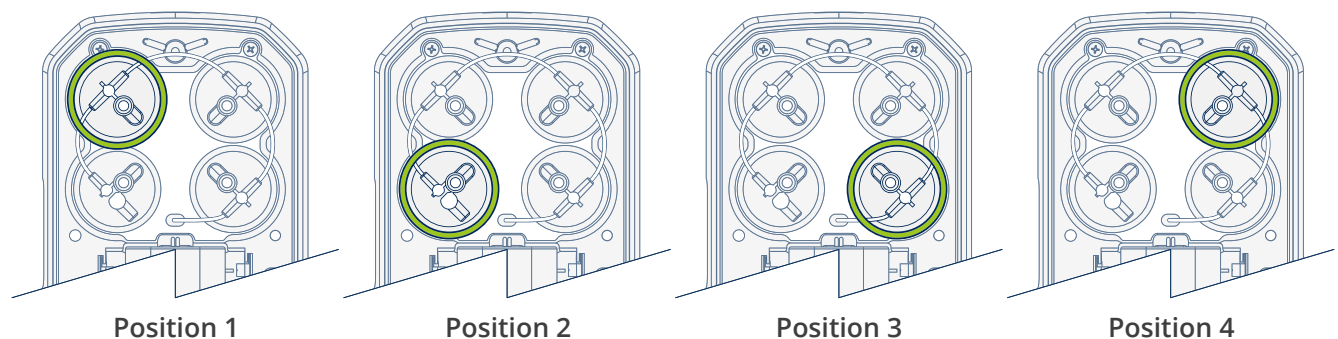
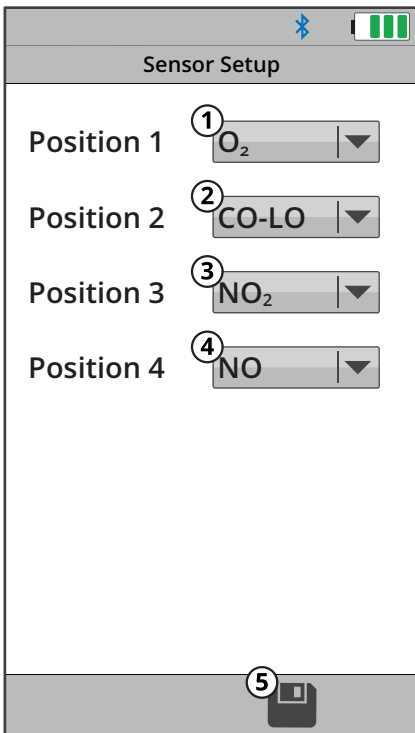

Fig. 4-3: Sensor Setup



- ① **Position 1** - the analyzer is required have an O₂ sensor in this position.
- ② **Position 2** - the analyzer can optionally have either CO_{LOW} or a CO_{HIGH} sensor in this position.
- ③ **Position 3** - the analyzer can optionally have None, NO₂ or a SO₂ sensor in this position.
- ④ **Position 4** - the analyzer can optionally have either None or a NO sensor in this position.
- ⑤ **Save** - save changes to Sensor Setup and return to the Settings menu.



IMPORTANT: To ensure accurate analysis results, sensors must be properly calibrated. See Calibration (*Section 5.5 and 5.6*) for more information.

Establish New Offset

Restart the analyzer in fresh air after changing the sensors to establish new offset.

4.9 Bluetooth® Setup

The PCA® 400 comes standard with Bluetooth® wireless communications; allowing users to quickly connect the instrument to an IrDA + Bluetooth® Printer.

Enabling Bluetooth®

- ▶ To enable Bluetooth® communications: *Main Menu* → *Settings* (⚙) → *Bluetooth* → select *On*



IMPORTANT: Interference can be caused by devices that are transmitting on the same frequency band.



WARNING: Use of radio connection may not be permitted in some locations (e.g. airplanes, hospitals). User assumes responsibility for complying with rules governing the use of radio connections.

4.10 Printer Setup

The PCA® 400 is capable of wirelessly transmitting data to compatible IrDA (*Infrared Data Associated*) or IrDA + Bluetooth® Printers. Users can quickly change between the two communication protocols by selecting the appropriate printer type from the analyzer's settings. (*For more information about wireless communication ranges, see Figures 2-6 and 2-7.*)



IMPORTANT: Printing via Bluetooth® is disabled when the analyzer is connected to the PCA® 400 App. If you wish to print, disconnect from the mobile app or enable IrDA communications.

Enabling Printing via IrDA

The analyzer can communicate data via IrDA at a distance of up to 16" (41 cm). IrDA communication requires that the analyzer has an unobstructed view of the printer at no more than a 30° angle.

- ▶ To enable the use of IrDA for printing: **Main Menu** → **Settings** (⊙) → **Printer** → select **IrDA**

Enabling Printing via Bluetooth®

The analyzer can communicate data via Bluetooth at a distance of up to 30' (*unobstructed*). Use of Bluetooth® will require that the communication protocol has been enabled (*Section 4.9*).

- ▶ To enable the use of Bluetooth® for printing: **Main Menu** → **Settings** (⊙) → **Printer** → **Bluetooth** → select **Pair** (if "Status: Not Paired") or **Skip** (if "Status: Paired")

Fig. 4-4: Printer Alignment for IrDA & Sample Printout

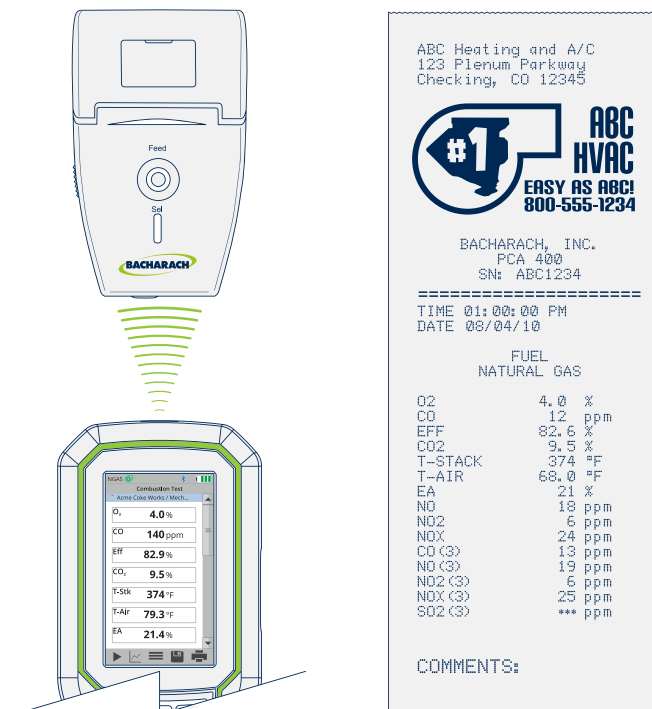

4.11 Onboard Data Logging

When the logging function is activated, up to 500 combustion test records can be automatically stored in memory at a preset interval over a predetermined duration.



IMPORTANT: If the combination of the logging duration / interval frequency exceeds the available memory, the analyzer will stop logging results once its memory is full. The analyzer DOES NOT overwrite existing records.

Logged data can either be viewed on the display using the analyzer's memory function, or downloaded to a personal computer using the supplied PCA® Reporting Software and Micro-B USB cable. Downloaded data is stored on the computer's hard drive as a comma separated value ASCII text file with a CSV extension, which can be opened by most spreadsheet programs for analysis (see Section 6.2 for more information about the PCA® Reporting Software).

| Logging Durations |
|-------------------|
| 5-minutes |
| 10-minutes |
| 15-minutes |
| 30-minutes |
| 1-hour |
| 2-hours |
| 5-hours |

| Logging Intervals |
|-------------------|
| 5-seconds |
| 10-seconds |
| 30-seconds |
| 1-minute |
| 5-minutes |
| 10-minutes |

Turning On Data Logging

- ▶ To enable Data Logging: **Options** (≡) → **Logging** → enable set parameters & time via dropdown menu → press **Save** (⏎)

Fig. 4-5: Data Logging Settings

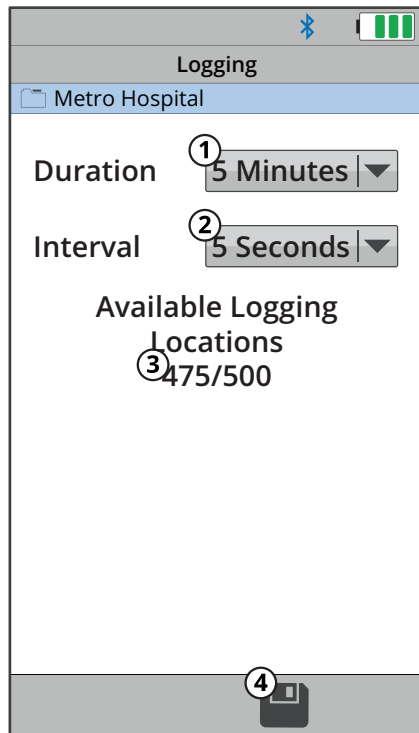

- ① **Duration** - total duration of the combustion test (5-minutes, 10-minutes, 15-minutes, 30-minutes, 1-hour, 2-hours and 5-hours).
- ② **Interval** - time elapsed in between logged results (5-seconds, 10-seconds, 15-seconds, 1-minute, 5-minutes and 10 minutes).
- ③ **Available Locations** - remaining memory for logged results.
- ④ **Save** - save changes to Data Logging Settings and return to the Combustion Test screen.

i **IMPORTANT:** Before turning ON data logging and starting the data logging process, the analyzer should already be setup to perform a combustion test. See Setup (Section 3.1) for more information.

i **IMPORTANT:** The amount of memory available of storing new data is displayed in the LOGGING screen (maximum of 500 locations). If previous sessions are stored and additional memory is needed, clear the memory.

4.12 Memory File Management

The PCA® 400 allows users to save up to 500 test records to the analyzer's internal memory.

Recalling Saved Test Data

- ▶ To recall individual test data records: *Main Menu* → *Memory* (📁) → select desired analysis results based on date / location

Fig. 4-6: Recalling Memory

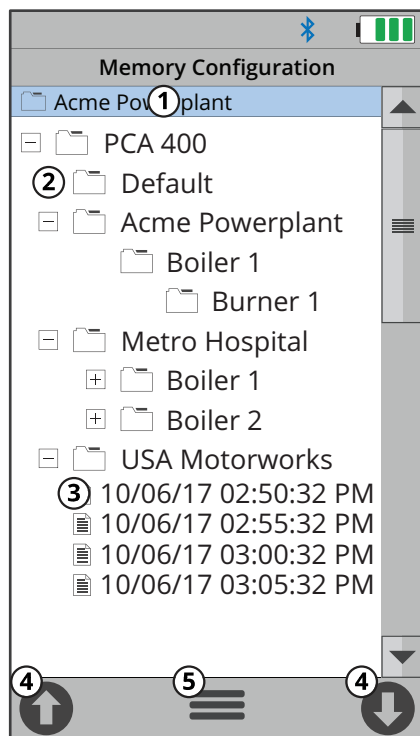

- ① **Folder / Memory Location** - targeted Folder / Memory Location where data will be saved.
- ② **Directory**
- ③ **Saved Test Results**
- ④ **Navigation Arrows** - scrolls to the 10 previous or next 10 files / records.
- ⑤ **Options** - displays additional settings / configuration (*Target, Edit, Add Folder, Delete All, Delete Files, Expand, Collapse*).

Navigating Memory

When viewing a directory, users can use the $\leftarrow \rightarrow$ buttons to open and close sub-directories. Users may also use the Navigation Arrows (*Figure 4-6*) on the touch interface to quickly scroll through saved records.

Clearing Memory

When all memory locations in the directory are full, they must be manually deleted in order to store new data.

- ▶ To delete test records: *Main Menu* → *Memory* (☰) → *Options* (≡) → select *Delete Files* → confirm by selecting *Yes*
- ▶ To delete folders and test records: *Main Menu* → *Memory* (☰) → *Options* (≡) → select *Delete All* → confirm by selecting *Yes*

4.13 Fresh Air Purge without Removing Probe

The PCA® 400 allows users to manually purge the analyzer with fresh air in order to keep the electrochemical sensors from overranging.

Turning On Purge Pump

- ▶ To start the 60-second Fresh Air Purge: *Options* (≡) → *Fresh Air Purge* → select *Yes*

4.14 Sensor Protection / Dilution Mode

Sensor Protection / Dilution Mode allows the instrument to dilute the gas sample in order to protect its sensors from over-ranging during combustion analysis.

Enabling Sensor Protection

Sensor Protection allows the PCA® 400 to engage a second pump, diluting the sample (*and all measurements*) with fresh air. A notification will alert the user that the dilution pump has been engaged, as well as a second pump icon (☉). Any print-outs / reports will also note that the analyzer was diluting measurements during analysis.

- ▶ To enable Sensor Protection / Dilution Mode: **Options** (☰) → **Sensor Protection** → select desired gases (**CO**, **NO**, **NO₂**, **SO₂**) and dilution threshold (**50%**, **75%** or **100% of Sensor Range**) → press **Save** (💾)

i **IMPORTANT:** Dilution Mode will run until ALL MEASUREMENTS fall below 80% of the set dilution threshold(s).

i **IMPORTANT:** If not already present, the following should be installed to ensure accurate measurement while the analyzer is in Dilution Mode:

- *Gaskets (P/N: 0024-1745) in all vents in the analyzer's component door.*
- *Vinyl Caps (P/N: 0005-4766) plugging vents where sensors are not present.*

Fig. 4-7: Dilution Mode Notifications

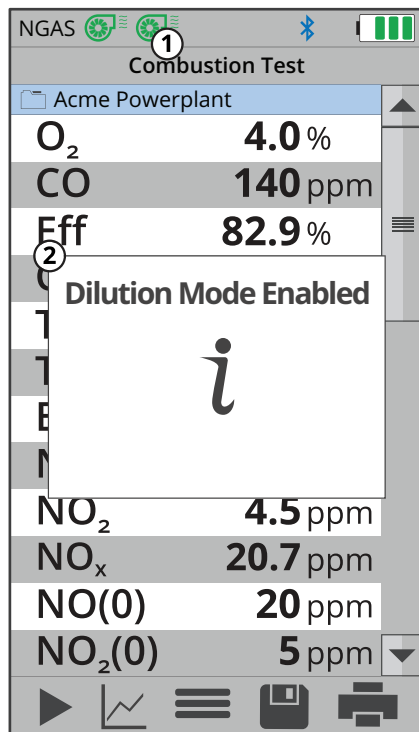

- ① Dilution Pump Status
- ② Notification

5. Care & Maintenance

| | | |
|-------|--|-----------|
| 5.1 | Emptying the Water Trap..... | 42 |
| 5.2 | Replacing the Filter Element | 43 |
| 5.3 | Cleaning the Probe Assembly..... | 44 |
| 5.4 | Sensor Replacement..... | 45 |
| 5.5 | B-Smart® Sensor Calibration | 48 |
| 5.5.1 | B-Smart® Sensors..... | 48 |
| 5.5.2 | Starting a Calibration..... | 49 |
| 5.5.3 | B-Smart® Sensor Calibration..... | 49 |
| 5.6 | Manual Sensor Calibration | 52 |
| 5.6.1 | Starting a Calibration..... | 52 |
| 5.6.2 | CO _{LOW} Sensor Calibration | 53 |
| 5.6.3 | SO ₂ Sensor Calibration | 56 |
| 5.6.4 | NO Sensor Calibration..... | 57 |
| 5.6.5 | NO ₂ Sensor Calibration | 58 |
| 5.6.6 | CO _{HIGH} Sensor Calibration..... | 60 |
| 5.7 | Troubleshooting | 61 |
| 5.7.1 | Error Codes..... | 61 |
| 5.7.2 | Error Symbols..... | 62 |
| 5.7.3 | Diagnostics & Status Screens..... | 62 |

5.1 Emptying the Water Trap

The Water Trap should be emptied after every test, or as water condensate approaches the tip of the riser tube.

1. Remove Water Trap Chamber

Pull apart the two halves of the Water Trap using a slight twisting motion to disengage the assembly's bayonet connection.

Fig. 5-1: Replacing the Water Trap Filter

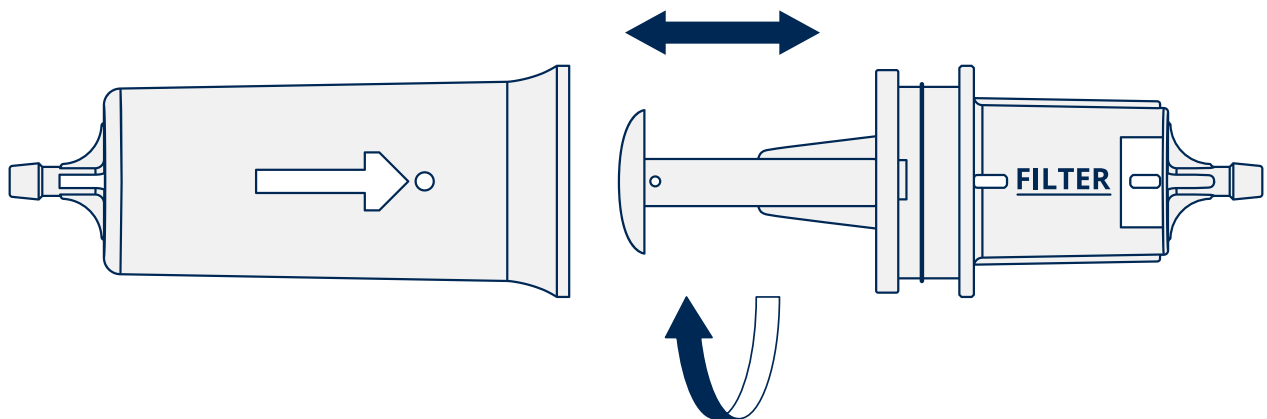

2. Pour Condensate & Reassemble Water Trap

Remove liquid condensate from the reservoir and reassemble the Water Trap by firmly pressing the bayonet connections into place and twisting in a clockwise fashion.

i IMPORTANT: When disassembling the Water Trap, care should be taken to ensure that the o-ring does not dislodge from the Water Trap Chamber.

5.2 Replacing the Filter Element

Replace the filter element when it becomes visibly dirty or becomes saturated with water.

Materials / Equipment Required

Before cleaning the probe assembly, obtain the following items:

- Water Trap Filter (P/N: 0007-1644)
- Small Flat-blade Screwdriver

1. Remove Water Trap Chamber

Pull apart the two halves of the Water Trap using a slight twisting motion.

Fig. 5-2: Disassembling the Water Trap / Filter Assembly

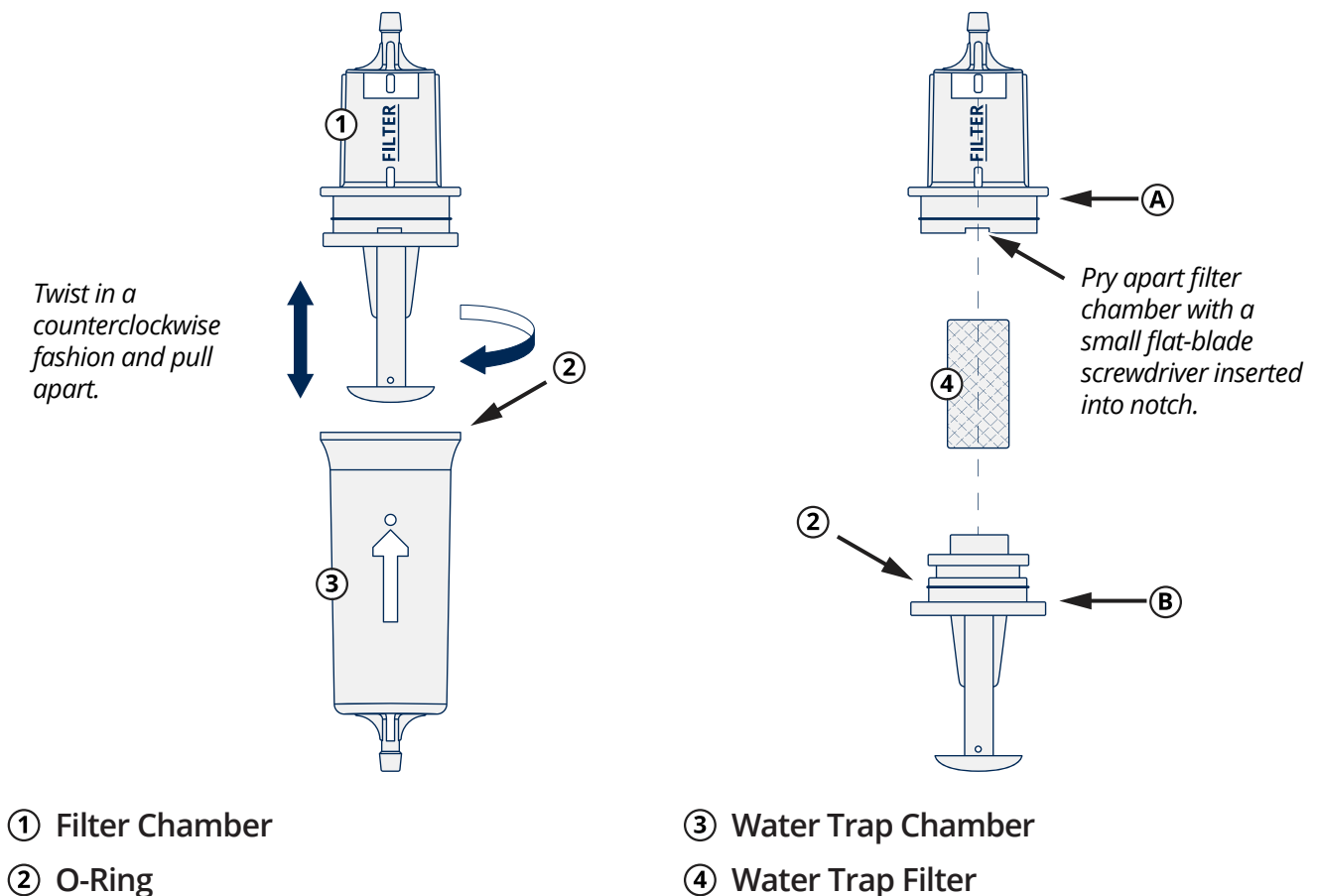

2. Open Filter Chamber

Using a small flat-blade screwdriver, pry apart the Filter Chamber. Remove and discard the old Water Trap Filter.

3. Install New Filter

Install new filter and reassemble the Filter Chamber, making sure that surfaces "A" and "B" contact each other.

4. Reassemble Water Trap Assembly

Firmly press the bayonet connections into place and twist in a clockwise fashion to secure.

5.3 Cleaning the Probe Assembly

The probe tube and sample line will become dirty during normal use.

 **IMPORTANT:** The water trap's filter element should prevent soot from reaching the analyzer's internal components. If the probe is not kept clean, it could become clogged and restrict the flow of gas into the analyzer, resulting in incorrect combustion test readings and calculations.

 **IMPORTANT:** An analyzer that is used to test natural gas furnaces normally requires less frequent cleaning than an one which is used for testing coal- or oil-fired furnaces.

Materials / Equipment Required

Before cleaning the probe assembly, obtain the following items:

- Alcohol
- Aerosol Can of Automotive Carburetor Cleaner
- Clean Cloth
- Source of Compressed Air (*User Discretion*)

 **DANGER:** NEVER use flammable or combustible substances (*like the carburetor fluid used to clean the probe*) near an open flame.

1. Disconnect Sample Line from Water Trap

Remove the sample line from the top of the water trap.



CAUTION: Carburetor cleaner will cause damage to plastic components. Take precautions to avoid spraying cleaner onto the probe handle or analyzer.

2. Clean Sample Line with Carburetor Cleaner

Insert the plastic spray tube of the carburetor cleaner into the sample line, and liberally spray the cleaner through the hose and out of the probe tube.

3. Flush Sample Line

After spraying, remove all of the residual cleaner by repeatedly flushing the sample line and probe tube with alcohol.

4. Clean Exterior

Wipe the surface of the probe assembly and sample line with a clean cloth.

5. Allow to Dry

Allow the parts to dry completely. If available, blow compressed air through the sample line and probe tube to accelerate the drying process.

6. Reconnect Sample Line to Water Trap

Pressing firmly, reconnect the sample line to the top of the water trap.

5.4 Sensor Replacement

All sensors are replaced in a similar manner. Do the following to replace either the O₂, CO_{LOW}, CO_{HIGH}, NO, NO₂, or SO₂ sensor. Refer to Part Numbers (*Section 7.1*) for a list of sensors and their part numbers.



IMPORTANT: The typical life expectancies for PCA® 400 sensors are as follows (*sensor life will depend on instrument use, environmental factors and gas concentration exposure history*):

- O₂ sensor has a life expectancy of 5 to 7-years,
- SO₂ and NO₂ sensors have life expectancies of 2-years,
- CO, CO_{HIGH} and NO sensors have life expectancies of 3-years.



IMPORTANT: If not already present, the following should be installed to ensure accurate measurement while the analyzer is in Dilution Mode:

- *Gaskets (P/N: 0024-1745) in all vents in the analyzer's component door.*
 - *Vinyl Caps (P/N: 0005-4766) plugging vents where sensors are not present.*
-

Materials / Equipment Required

Before beginning the process of replacing sensors, obtain the following items:

- ☐ Phillips-head Screwdriver
- ☐ Replacement Sensor

1. Turn OFF the Analyzer

Press and hold the Power Key and allow the analyzer to complete its shutdown procedure.

2. Remove the Analyzer's Rear Cover

Using a Phillips-head screwdriver, remove the Battery & Component Doors from the rear of the analyzer.

Fig. 5-3: Removing Battery & Component Doors

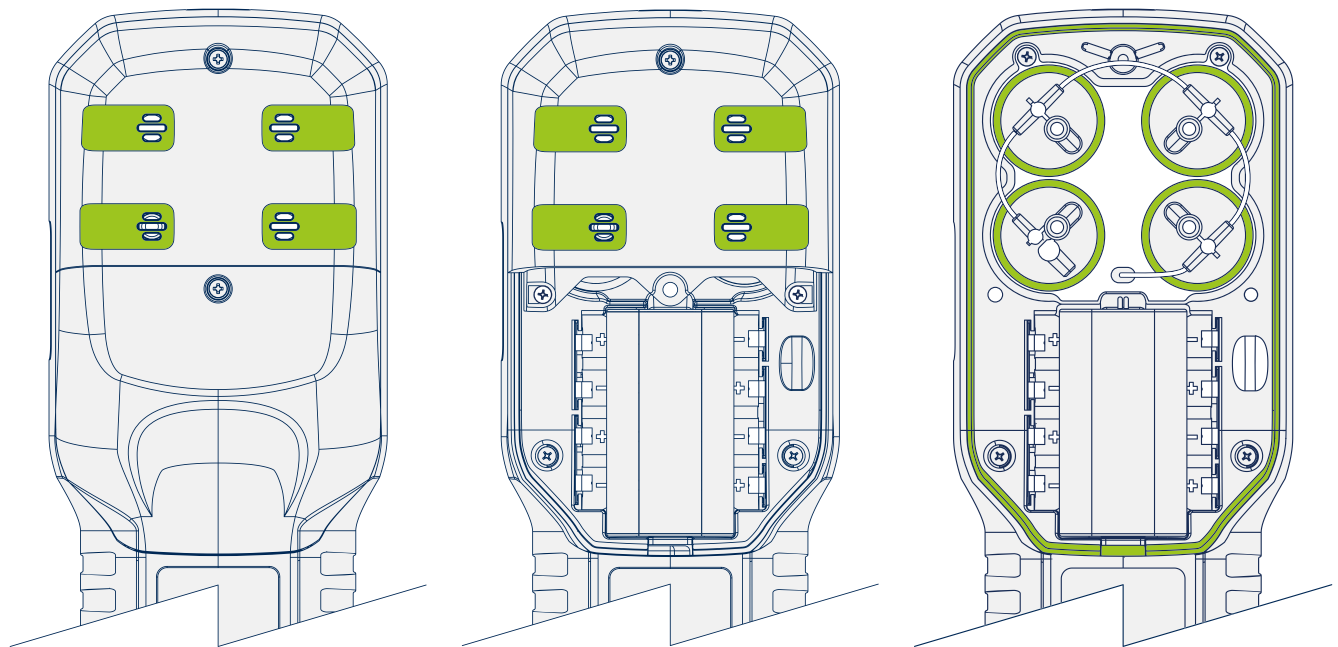

3. Disconnect the Old Sensor

Locate the sensor which is to be replaced (*sensor positions are denoted by a 1, 2, 3 or 4*), remove sample tubing and unplug the sensor assembly from the board.

4. Remove Sensor Cap Assembly

While holding the base of the sensor, firmly twist the gas cup in a counterclockwise fashion and pull straight up to remove.

5. Remove Shorting Springs from Replacement Sensor

Remove the replacement sensor from its plastic canister / packaging. Note that the CO_{LOW}, CO_{HIGH}, SO₂ and NO₂ sensors have a shorting spring installed between two of their pins. Remove and discard this spring before installing the sensor

Fig. 5-4: Discard Shorting Springs

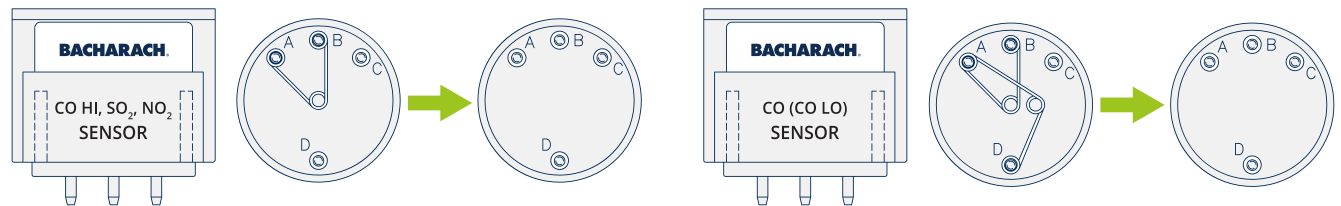

6. Attach Sensor Cap Assembly

Attach the cap assembly to the replacement sensor by inserting the sensor into the gas cup and twisting in a clockwise fashion.

7. Connect Replacement Sensor

Firmly press the sensor into the vacant position on the board and reconnect the sample tubing to the gas cup.



IMPORTANT: When connecting the sensor assembly, it is important that the tubing is free of crimps which could obstruct the flow of sample gases. (See Figure 5-5 for proper sensor cap orientation.)

8. Reinstall the Analyzer's Rear Cover

Using a Phillips-head screwdriver, return Battery & Component Doors to the rear of the analyzer.

9. Allow Replacement Sensor to Stabilize

Allow the sensor which was just installed time to stabilize in the circuit before continuing with this procedure. Stabilization time for all sensors (except for the NO sensor) is about 1-hour. The NO sensor baseline technically requires several days to stabilize, but should be sufficiently stabilized for use in approximately 4-hours.

10. Turn ON the Analyzer

Press the Power Key and ensure that no sensor errors occur during the 60-second warm-up.



IMPORTANT: Discard old sensors in accordance with local and federal hazardous waste disposal laws.

11. Calibrate Replacement Sensor

Enter the B-Smart® calibration code or manually calibrate the replacement sensor as explained in Calibration (*Sections 5.5 and 5.6*). The exception to this instruction is the O₂ sensor which does not require calibration.

5.5 B-Smart® Sensor Calibration



IMPORTANT: Before performing any calibration procedures, ensure that the analyzer's batteries have sufficient charge or use the optional AC power adapter. Also, ensure that the analyzer is at room temperature and is sampling fresh air when turned ON.

5.5.1 B-Smart® Sensors

The PCA® 400 uses Bacharach's B-Smart® Sensor technology for CO_{LOW}, CO_{HIGH}, NO, NO₂ and SO₂. The B-Smart® Sensor is marked with a 10- or 14-digit calibration code which can be entered via the analyzer's interface.

Benefits of the B-Smart® Sensors include the following:

- New sensors can be installed without applying gas for calibration,
- Sensors can be pre-calibrated and installed when needed,
- Sensors can be moved from one analyzer to another and
- The analyzer's diagnostics screen shows which sensors have been installed and their current end-of-life condition (*Good or Low*).

Sensors should be calibrated by an authorized Bacharach Service Center (*Section 7.2*) every 6-months to 1-year to ensure that the analyzer continues to meet its published accuracy specifications. B-Smart® Sensors, however, can be calibrated in the field if your facility has the necessary equipment and qualified personnel to perform the procedures described in the following sections.

5.5.2 Starting a Calibration

Start any calibration procedure by taking the following steps:

1. Turn ON the Analyzer

Turn the analyzer ON, allowing it to cycle through its 60-second warm-up period in fresh air. During the warm-up, the analyzer's operation is checked and sensors are set to the following ambient conditions:

- O₂ sensor spanned to 20.9%,
- All gas sensors are zeroed,
- The pressure sensor is zeroed.

2. Address Warm-Up Errors

Any errors detected during warm-up will be listed on the display immediately following warm-up. Correct any errors before proceeding. Refer to Error Codes (*Section 5.7.1*) for a list of error messages and their meanings.

3. Access Calibration Menu

Access the CALIBRATION MENU and use the analyzer's touch screen or keypad to enter the 4-digit calibration password. (*The calibration password can be changed and / or disabled using the optional PCA® Reporting Software.*)

- ▶ To access the CALIBRATION MENU: *Main Menu* → *Calibrate* (⊕)
- ▶ PCA® 400 default calibration password: *1111* → press *Enter* (↵)

5.5.3 B-Smart® Sensor Calibration

To replace / calibrate a B-Smart® sensor, do the following:

1. Access the B-Smart® Calibration Menu

- ▶ To access the B-Smart® Calibration Menu: *Calibration Menu* → *B-Smart*

2. Scan or Manually Enter B-Smart® Calibration

If your analyzer supports Near Field Communication (*NFC*), you may select SCAN CODE to enter the calibration code.

- ▶ Select SCAN CODE and hold the lid from the sensor packaging near the PCA® 400 logo on the base of the analyzer.

If you have chosen the MANUAL ENTRY method, enter the alphanumeric code supplied with the B-Smart® Sensor.

- ▶ Select MANUAL ENTRY and use the analyzer's touch screen or keypad to enter the 10- or 14-digit calibration code.



IMPORTANT: There are two B-Smart® Sensor code lengths:

- 10-digits for CO_{HIGH} , NO , NO_2 and SO_2 ,
- 14-digits for CO_{LOW} .



IMPORTANT: If the correct code was entered, a confirmation message will display the calibration code, the sensor type and the position of the sensor being replaced. If an incorrect code was entered, the screen will display SENSOR: UNKNOWN. Check to make sure the correct code has been entered. If the problem persists, (Section 7.2).

3. Turn OFF the Analyzer

Press and hold the Power Key and allow the analyzer to complete its shutdown procedure

4. Remove Cover & Locate Sensor Position

After the calibration code has been accepted, a confirmation message will display the position of the sensor being replaced. Remove the analyzer's rear cover and located the sensor which is to be replaced. (*Sensor positions are denoted by a 1, 2, 3 or 4.*)

Fig. 5-5: Gas Sensor Positions

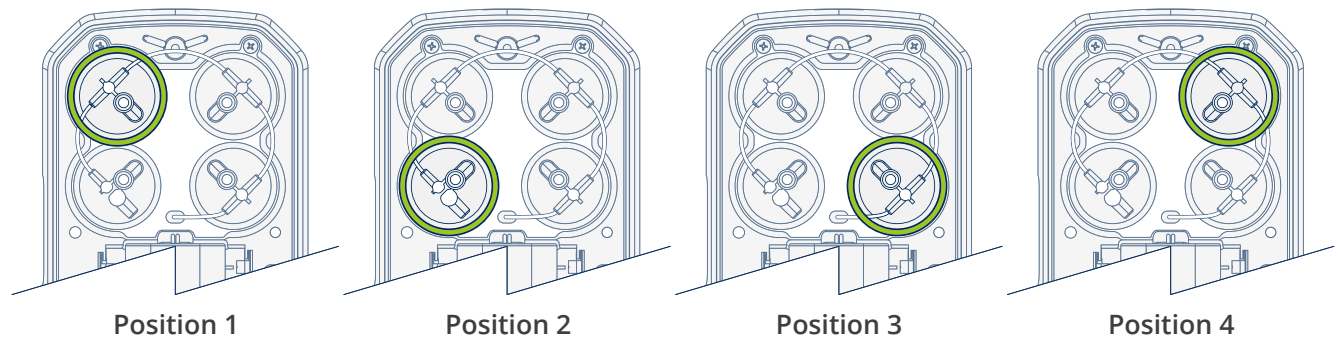

5. Disconnect Sensor from Board

Take care not to bend the connector pins on the base of the sensor when removing from the analyzer. Disconnect sample tubing from the cap assembly and pull sensor from the board.

6. Remove Cap Assembly (Gas Cup)

While holding the base of the sensor, firmly twist the cap assembly in a counterclockwise fashion to remove. (*Set the old sensor aside if it is to be returned to Bacharach for recalibration.*)

i **IMPORTANT:** If the replacement sensor was purchased through the B-Smart® Sensor Exchange Program, it is important that the old sensor is returned to our factory to be recalibrated.

1. Place the old sensor in the bubble wrap and plastic container supplied with the replacement B-Smart® sensor.
2. Seal the plastic container in the pre-paid shipping envelope and return it to Bacharach, Inc. at the following address:

7. Remove Shorting Springs from Replacement Sensor

Remove any shorting springs which are present on the sensor pins before installation.

Fig. 5-6: Shorting Springs

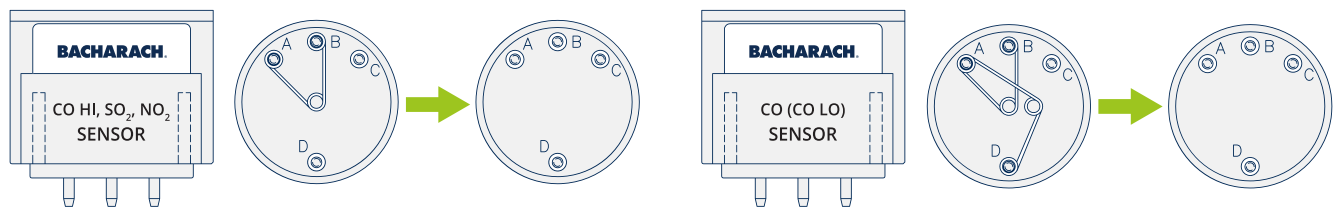

8. Attach Sensor Cap Assembly

Attach the cap assembly to the replacement sensor by inserting the sensor into the gas cup and twisting in a clockwise fashion.

9. Connect Replacement Sensor

Firmly press the sensor into the vacant position on the board and reconnect the sample tubing to the gas cup.

i **IMPORTANT:** When connecting the sensor assembly, it is important that the tubing is free of crimps which could obstruct the flow of sample gases. (See Figure 5-5 for proper sensor cap orientation.)

10. Reinstall the Analyzer's Rear Cover

Using a Phillips-head screwdriver, return Battery & Component Doors to the rear of the analyzer.

11. Allow Replacement Sensor to Stabilize

Allow the sensor which was just installed to stabilize in the circuit before continuing with this procedure. Stabilization time for all sensors (*except for the NO sensor*) is about 1-hour. The NO sensor baseline technically requires several days to stabilize, but should be sufficiently stabilized for use in approximately 4-hours.

12. Turn ON the Analyzer

Turn the analyzer ON, allowing it to cycle through its 60-second warm-up period in fresh air.

5.6 Manual Sensor Calibration

5.6.1 Starting a Calibration

Start any calibration procedure by taking the following steps:

1. Turn ON the Analyzer

Turn the analyzer ON, allowing it to cycle through its 60-second warm-up period in fresh air. During the warm-up, the analyzer's operation is checked and sensors are set to the following ambient conditions:

- O₂ sensor spanned to 20.9%,
- All gas sensors are zeroed,
- The pressure sensor is zeroed.

2. Address Warm-Up Errors

Any errors detected during warm-up will be listed on the display immediately following warm-up. Correct any errors before proceeding. Refer to Error Codes (*Section 5.7.1*) for a list of error messages and their meanings.

3. Access Calibration Menu

Access the CALIBRATION MENU and use the analyzer's touch screen or keypad to enter the 4-digit calibration password. (*The calibration password can be changed and / or disabled using the optional PCA® Reporting Software.*)

- ▶ To access the CALIBRATION MENU: **Main Menu** → **Calibrate** (⚙️)
- ▶ PCA® 400 default calibration password: **1111**

5.6.2 CO_{LOW} Sensor Calibration

i **IMPORTANT:** The CO_{LOW} sensor also measures H₂ for the purpose of compensating the CO reading for the presence of H₂ in the gas sample. This procedure first spans the CO_{LOW} sensor and, optionally, spans the H₂ part of the sensor to know gas levels.

Materials / Equipment Required

Before manually calibrating the CO_{LOW} sensor, obtain the following items:

- Calibration Kit (P/N: 0024-7059)
- Gas Cylinder (500 ppm CO in air, P/N: 0024-0492)
- Gas Cylinder (1,000 ppm CO and 1,000 ppm H₂ in Nitrogen, P/N: 0024-0794)

Fig. 5-7: Gas Sensor Calibration Equipment

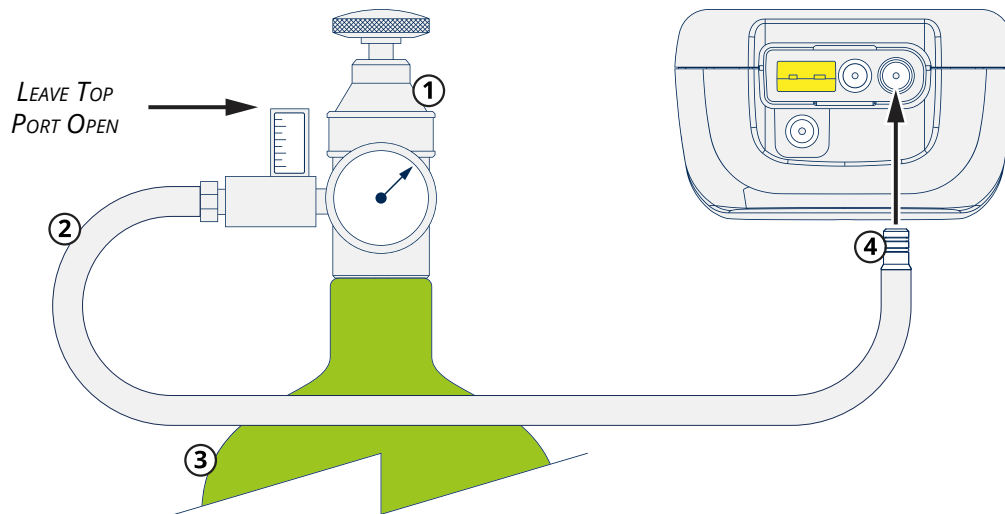

① Regulator*

② 3/16" I.D. Tubing*

* Part of Calibration Kit (P/N: 0024-7059)

③ Gas Cylinder

④ Gas Connector*

1. Access the CO Calibration Menu

► To access the CO Calibration Menu: *Calibration Menu* → *CO* → *CO + H₂*



IMPORTANT: “Measured” is the current CO reading, while “Applied” refers to the known CO level which will be applied to the sensor for calibration purposes.



CAUTION: Unless instructed by the manufacturer or an authorized service provider, DO NOT reset sensor gain (⊖) during the calibration process.

2. Apply 500 ppm CO to the Sensor

Attach a 500 ppm CO cylinder to the regulator. (For more information about the Gas Sensor Calibration Equipment, see Figure 5-7.)

3. Adjust Flow Rate

Adjust the regulator to ensure that the flow rate is sufficient enough to calibrate the sensor. (For more information about adjusting the flow rate, see Figure 5-8.)

Fig. 5-8: Adjusting the Flow Rate

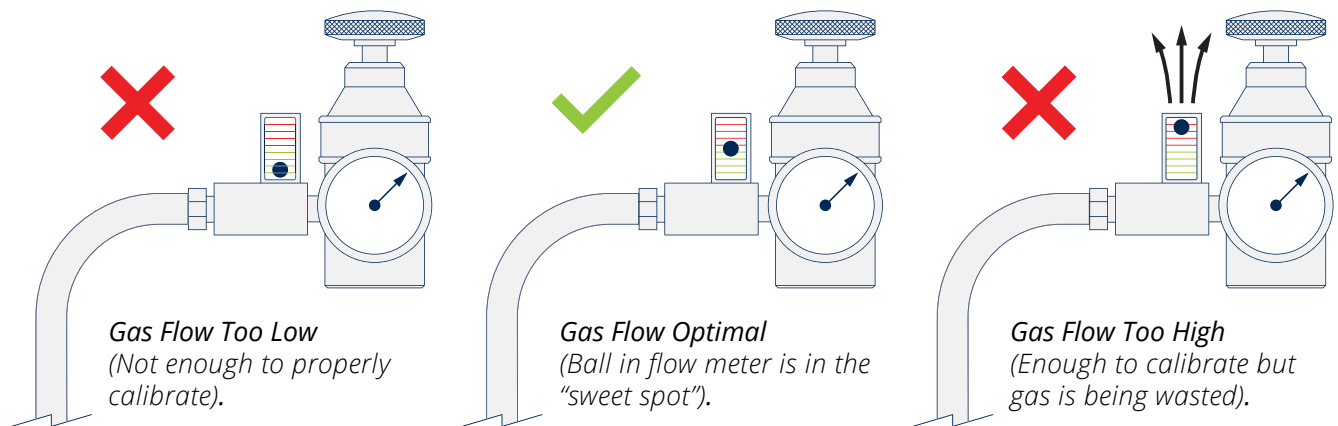

IMPORTANT: During the calibration process, open then adjust the knob on the regulator to provide calibration gas to the target sensor. As you open the knob of the regulator, the white ball inside of the flow meter will rise. Adjust the gas flow so that the ball floats in the center of the flow meter (where the green and red hash marks meet). This ensures sufficient gas for calibration with minimal waste escaping through the top of the flow meter.

4. Enter Applied Value

Using the touch interface or keypad buttons, enter an applied value which exactly equals the concentration stamped on the CO cylinder.



IMPORTANT: The calibration range is from 9 to 1,500 ppm. An attempt to calibrate outside of this range will cause the message “Applied Value High” or “Applied Value Low” appear at the bottom of the screen.

5. Allow Reading to Stabilize

Wait until the measured reading stabilizes (*approximately 3 minutes*), and press Save (■) to calibrate the CO measured value to that of the applied value. The display will advance to the TEST GAS CO / H₂ screen.

6. Remove Calibration Cylinder

Turn OFF regulator and remove the 500 ppm CO cylinder.

7. Apply 1,000 ppm CO & 1,000 ppm H₂ to the Sensor

Attach a combination 1,000 ppm CO and 1,000 ppm H₂ cylinder to the regulator of the calibration fixture.

8. Enter the CO Portion of the Calibration Gas Mixture

Using the touch interface or keypad buttons, enter an applied value which exactly equals the CO concentration stamped on the CO / H₂ cylinder and press Save (■) to advance to the CALIBRATE H₂ screen.



IMPORTANT: The calibration range is from 9 to 1,500 ppm. An attempt to calibrate outside of this range will cause the message “Applied Value High” or “Applied Value Low” appear at the bottom of the screen.

9. Enter the H₂ Portion of the Calibration Gas Mixture

Using the touch interface or keypad buttons, enter an applied value which exactly equals the CO concentration stamped on the CO / H₂ cylinder.



IMPORTANT: The calibration range is from 9 to 1,500 ppm. An attempt to calibrate outside of this range will cause the message “Applied Value High” or “Applied Value Low” appear at the bottom of the screen.

10. Allow Reading to Stabilize

Wait until the measured reading stabilizes (*approximately 3 minutes*), and press Save (☒) to calibrate the H₂ measured value to that of the applied value. The message “Good Calibration” should briefly appear followed by the CALIBRATION LIST screen.



IMPORTANT: If the sensor’s output is low, but still usable, the message “Good Calibration WARNING Low Sensor” will appear. The sensor will now be marked as being “Low” in the DIAGNOSTICS screen.



IMPORTANT: If the sensor’s output is too low to be usable, the message “Bad Calibration Sensor End of Life” will appear.

11. Remove Calibration Cylinder

Turn OFF regulator and remove the 1,000 ppm CO and 1,000 ppm H₂ cylinder.

5.6.3 SO₂ Sensor Calibration

Materials / Equipment Required

Before manually calibrating the SO₂ sensor, obtain the following items:

- ☐ Calibration Kit (P/N: 0024-7059)
- ☐ Gas Cylinder (100 ppm SO₂ in Nitrogen, P/N: 0024-1158)

1. Access the SO₂ Calibration Menu

- ▶ To access the SO₂ Calibration Menu: *Calibration Menu* → SO₂



IMPORTANT: “Measured” is the current SO₂ reading, while “Applied” refers to the known SO₂ level which will be applied to the sensor for calibration purposes.



CAUTION: Unless instructed by the manufacturer or an authorized service provider, DO NOT reset sensor gain (☉) during the calibration process.

2. Apply 100 ppm SO₂ to the Sensor

Attach a 100 ppm SO₂ cylinder to the regulator. (*For more information about the Gas Sensor Calibration Equipment, see Figure 5-7.*)

3. Adjust Flow Rate

Adjust the regulator to ensure that the flow rate is sufficient enough to calibrate the sensor. (*For more information about adjusting the flow rate, see Figure 5-8.*)

4. Enter Applied Value

Using the touch interface or keypad buttons, enter an applied value which exactly equals the concentration stamped on the SO₂ cylinder.

 **IMPORTANT:** The calibration range is from 9 to 1,800 ppm. An attempt to calibrate outside of this range will cause the message “Applied Value High” or “Applied Value Low” appear at the bottom of the screen.

5. Allow Reading to Stabilize

Wait until the measured reading stabilizes (*approximately 3 minutes*), and press Save (☒) to calibrate the SO₂ measured value to that of the applied value. The message “Good Calibration” should briefly appear followed by the CALIBRATION LIST screen.

 **IMPORTANT:** If the sensor’s output is low, but still usable, the message “Good Calibration WARNING Low Sensor” will appear. The sensor will now be marked as being “Low” in the DIAGNOSTICS screen.

 **IMPORTANT:** If the sensor’s output is too low to be usable, the message “Bad Calibration Sensor End of Life” will appear.

6. Remove Calibration Cylinder

Turn OFF regulator and remove the 100 ppm SO₂ cylinder.

5.6.4 NO Sensor Calibration

Materials / Equipment Required

Before manually calibrating the NO sensor, obtain the following items:

- Calibration Kit (P/N: 0024-7059)
- Gas Cylinder (100 ppm NO in Nitrogen, P/N: 0024-1697)

1. Access the NO Calibration Menu

- ▶ To access the NO Calibration Menu: *Calibration Menu* → *NO*
-

 **IMPORTANT:** “Measured” is the current NO reading, while “Applied” refers to the known NO level which will be applied to the sensor for calibration purposes.

 **CAUTION:** Unless instructed by the manufacturer or an authorized service provider, DO NOT reset sensor gain (⊖) during the calibration process.

2. Apply 100 ppm NO to the Sensor

Attach a 100 ppm NO cylinder to the regulator. (*For more information about the Gas Sensor Calibration Equipment, see Figure 5-7.*)

3. Adjust Flow Rate

Adjust the regulator to ensure that the flow rate is sufficient enough to calibrate the sensor. (For more information about adjusting the flow rate, see Figure 5-8.)

4. Enter Applied Value

Using the touch interface or keypad buttons, enter an applied value which exactly equals the concentration stamped on the NO cylinder.

i **IMPORTANT:** The calibration range is from 9 to 900 ppm. An attempt to calibrate outside of this range will cause the message “Applied Value High” or “Applied Value Low” appear at the bottom of the screen.

5. Allow Reading to Stabilize

Wait until the measured reading stabilizes (*approximately 3 minutes*), and press Save (■) to calibrate the NO measured value to that of the applied value. The message “Good Calibration” should briefly appear followed by the CALIBRATION LIST screen.

i **IMPORTANT:** If the sensor’s output is low, but still usable, the message “Good Calibration WARNING Low Sensor” will appear. The sensor will now be marked as being “Low” in the DIAGNOSTICS screen.

i **IMPORTANT:** If the sensor’s output is too low to be usable, the message “Bad Calibration Sensor End of Life” will appear.

6. Remove Calibration Cylinder

Turn OFF regulator and remove the 100 ppm NO cylinder.

5.6.5 NO₂ Sensor Calibration

Materials / Equipment Required

Before manually calibrating the NO₂ sensor, obtain the following items:

- Calibration Kit (P/N: 0024-7059)
- Gas Cylinder (100 ppm NO₂ in Nitrogen, P/N: 0024-1157)

1. Access the NO₂ Calibration Menu

- ▶ To access the NO₂ Calibration Menu: *Calibration Menu* → NO₂



IMPORTANT: “Measured” is the current NO₂ reading, while “Applied” refers to the known NO₂ level which will be applied to the sensor for calibration purposes.



CAUTION: Unless instructed by the manufacturer or an authorized service provider, DO NOT reset sensor gain (⊖) during the calibration process.

2. Apply 100 ppm NO₂ to the Sensor

Attach a 100 ppm NO₂ cylinder to the regulator. (For more information about the Gas Sensor Calibration Equipment, see Figure 5-7.)

3. Adjust Flow Rate

Adjust the regulator to ensure that the flow rate is sufficient enough to calibrate the sensor. (For more information about adjusting the flow rate, see Figure 5-8.)

4. Enter Applied Value

Using the touch interface or keypad buttons, enter an applied value which exactly equals the concentration stamped on the NO₂ cylinder.)



IMPORTANT: The calibration range is from 9 to 150 ppm. An attempt to calibrate outside of this range will cause the message “Applied Value High” or “Applied Value Low” appear at the bottom of the screen.

5. Allow Reading to Stabilize

Wait until the measured reading stabilizes (*approximately 3 minutes*), and press Save (☑) to calibrate the NO₂ Measured value to that of the applied value. The message “Good Calibration” should briefly appear followed by the CALIBRATION LIST screen.



IMPORTANT: If the sensor’s output is low, but still usable, the message “Good Calibration WARNING Low Sensor” will appear. The sensor will now be marked as being “Low” in the DIAGNOSTICS screen.



IMPORTANT: If the sensor’s output is too low to be usable, the message “Bad Calibration Sensor End of Life” will appear.

6. Remove Calibration Cylinder

Turn OFF regulator and remove the 100 ppm NO₂ cylinder.

5.6.6 CO_{HIGH} Sensor Calibration

Materials / Equipment Required

Before manually calibrating the CO_{HIGH} sensor, obtain the following items:

- ❑ Calibration Kit (P/N: 0024-7059)
- ❑ Gas Cylinder (500 ppm CO in Air, P/N: 0024-0492)

1. Access the CO Calibration Menu

- ▶ To access the CO_{HIGH} Calibration Menu: *Calibration Menu* → *CO*



IMPORTANT: “Measured” is the current CO reading, while “Applied” refers to the known CO level which will be applied to the sensor for calibration purposes.



CAUTION: Unless instructed by the manufacturer or an authorized service provider, **DO NOT** reset sensor gain (⊖) during the calibration process.

2. Apply 500 ppm CO to the Sensor

Attach a 500 ppm CO cylinder to the regulator. (For more information about the Gas Sensor Calibration Equipment, see Figure 5-7.)

3. Adjust Flow Rate

Adjust the regulator to ensure that the flow rate is sufficient enough to calibrate the sensor. (For more information about adjusting the flow rate, see Figure 5-8.)

4. Enter Applied Value

Using the touch interface or keypad buttons, enter an applied value which exactly equals the concentration stamped on the CO cylinder.



IMPORTANT: The calibration range is from 100 to 5,000 ppm. An attempt to calibrate outside of this range will cause the message “Applied Value High” or “Applied Value Low” appear at the bottom of the screen.

5. Allow Reading to Stabilize

Wait until the measured reading stabilizes (approximately 3 minutes), and press Save (⌘) to calibrate the CO Measured value to that of the applied value. The message “Good Calibration” should briefly appear followed by the CALIBRATION LIST screen.



IMPORTANT: If the sensor’s output is low, but still usable, the message “Good Calibration WARNING Low Sensor” will appear. The sensor will now be marked as being “Low” in the DIAGNOSTICS screen.



IMPORTANT: If the sensor’s output is too low to be usable, the message “Bad Calibration Sensor End of Life” will appear.

6. Remove Calibration Cylinder

Turn OFF regulator and remove the 500 ppm CO cylinder.

5.7 Troubleshooting

5.7.1 Error Codes

| Message | Message Type | Description |
|----------------------------------|--------------|---|
| T-STK Disconnected | Warning | The probe thermocouple is not connected to the analyzer's T-Stack connector. Plug the probe thermocouple plug into the T-Stack connector at the bottom of the instrument. |
| Bad Sensor | Error | O ₂ sensor output is too low and cannot be calibrated in the instrument and needs replaced. |
| Low Sensor | Warning | O ₂ , CO _{LOW} , CO _{HIGH} , NO, NO ₂ or SO ₂ sensor output(s) were low but still usable. Sensor(s) may need to be replaced in the near future. Message will indicate which sensor(s) are in warning. |
| Off Bias - O2 | Warning | The O ₂ sensor has been without power for a prolonged period and has lost bias. The sensor will be disabled until it has stabilized. |
| Off Bias - NO | Warning | The NO sensor has been without power for a prolonged period and has lost bias. The sensor will be disabled until it has stabilized. |
| Applied Value High or Low | N/A | An attempt was made to calibrate a sensor outside its calibration range. |
| Warm-up Sensor Error | Error | <ul style="list-style-type: none"> CO, CO_{HIGH}, NO, NO₂, or SO₂ sensor(s) were not zeroed at warm-up because of high output. Run instrument in fresh air then restart instrument to re-zero sensor(s). If message persists, sensor(s) may need to be replaced. Message will indicate which channel(s) are in error. Stack or Air temperature channel is measuring temperature outside the range of -4 to 212° F (-20 to 100° C) at startup. Make sure that the Stack and Air Thermocouples are sampling ambient room air within the temperature range at startup. Pressure sensor is measuring pressure outside the range of ±3 inches of water column at startup. Ensure that the analyzer is sampling atmospheric pressure and restart the analyzer. The instrument was turned on with the probe sampling flue gas. Move the probe to fresh air and restart the analyzer. |

5.7.2 Error Symbols

| Symbol | Description |
|--------|---|
| --- | Three hyphens or dashes indicates that the calculated data cannot be displayed because the measured data necessary to make the calculation is out of range. For calculations to occur, the oxygen level must be below 16% and the stack temperature must be below 2,000 °F (1,093 °C). |
| *** | Three stars appear in the data field of sensors that are not installed, defective, or found to be in error during warm-up, and also in the data fields of that sensor's related calculated values. For example, if the data field of either the NO or NO ₂ sensor contains three stars, then the NO _x data field will also contain three stars. |
| XXX | Indicates sensor over range. |

5.7.3 Diagnostics & Status Screens

Device Status

Displays the analyzer's status and any errors which should be addressed (*Section 5.7.1*).

- ▶ To display Device Status: *Main Menu* → *Status (i)* → *Device Status*

Device Info

Displays the analyzer's software version, boot version and serial number.

- ▶ To display Device Info: *Main Menu* → *Status (i)* → *Device Info*

Main Diagnostics

Displays the analyzer's current sensor status.

- ▶ To display Main Diagnostics: *Main Menu* → *Status (i)* → *Main Diagnostics*

Instrument Hours

Displays total run time of the analyzer in hours of operation.

- ▶ To display Instrument Hours: *Main Menu* → *Status (i)* → *Instrument Hours*

Pump Hours

Displays the total run time of the sample and purge pumps in hours of operation.

- ▶ To display Pump Hours: *Main Menu* → *Status (i)* → *Pump Hours*

Memory Allocation

Displays the number of available records out of the analyzer's limit of 500.

- ▶ To display Memory Allocation: *Main Menu* → *Status (i)* → *Memory Allocation*

Folder Allocation

Displays the number of available folders out of the analyzer's limit of 30.

- ▶ To display Folder Allocation: *Main Menu* → *Status (i)* → *Folder Allocation*

Date and Time

Displays the date and time. Users can change the date and time by accessing the Settings Menu (*Section 4.2*).

- ▶ To display Time and Date: *Main Menu* → *Status (i)* → *Time and Date*

Bluetooth® Link

Displays the status of the analyzer's Bluetooth® communications.

- ▶ To display Bluetooth® Link: *Main Menu* → *Status (i)* → *Bluetooth Link*

Battery Status

Displays the charge remaining.

- ▶ To display Battery Status: *Main Menu* → *Status (i)* → *Battery Status*

6. Additional Information

| | | |
|-------|---|-----------|
| 6.1 | Technical Specifications | 64 |
| 6.1.1 | Instrument Details | 64 |
| 6.1.2 | Approvals | 65 |
| 6.1.3 | Measurement Range & Accuracy..... | 65 |
| 6.1.4 | Calculated Readings | 66 |
| 6.2 | PCA® Reporting Software | 67 |
| 6.2.1 | Downloaded Stored Data to a Computer..... | 67 |
| 6.2.2 | Importing Saved Data..... | 67 |
| 6.3 | PCA® 400 App | 69 |

6.1 Technical Specifications

6.1.1 Instrument Details

| Specification | Description / Part Number | |
|--------------------------------------|---|---|
| Dimensions H×W×D | 10.0" × 3.8" × 2.5" (25.40 × 9.65 × 6.35 cm) | |
| Weight | Analyzer with Battery Pack | 1.5 lb (.68 kg) |
| | Sample Line & Probe Assembly | 1.2 lb (.54 kg) |
| Operating Conditions | Temperature: | 23° to 113° F (0° to 45° C) |
| | Humidity: | 15 to 90% RH, non-condensing |
| | Air Pressure: | 1 atmosphere ±10% |
| Storage Conditions | Temperature: | -4° to 122° F (-20° to 50° C) |
| | Humidity: | 15 to 95% RH, non-condensing |
| | Air Pressure: | 1 atmosphere ±10% |
| Power Supply | Battery Pack: | Lithium-ion Battery Pack..... ≈ 12-Hours* |
| | 4 × AA Batteries: | 4 × AA Disposable Lithium Batteries ≈ 12-Hours* 4 × AA Disposable Alkaline Batteries..... ≈ 5-Hours* |
| | AC Adapter: | 100-240VAC @ 47-63 Hz..... Continuous |
| Display | 4.3" Full-color LCD Display, Resistive Touch Interface | |
| Wireless Communications | IrDA: | Printer(s) |
| | Bluetooth®: | Printer(s), Smart Device(s) |
| Sensors | O ₂ , CO-H ₂ , CO _{HIGH} , NO, NO ₂ , SO ₂ | |
| Initialization / Zeroing Time | 60-seconds | |

* The denoted battery life is representative of normal operation using the optional screen-dimming setting.

6.1.2 Approvals

| Approval | Description |
|---------------|--|
| EN 50270:2015 | EMC tested in accordance with European Directive 2014/30/EU. Electromagnetic compatibility: electrical apparatus for the detection and measurement of combustible gases, toxic gases and oxygen. |
| FCC: | FCC Part 15.225 and RSS 210 – Intentional Radiator |

6.1.3 Measurement Range & Accuracy



IMPORTANT: When the PCA® 400 is in Dilution Mode, the analyzer's accuracy will be the range stated in the following table plus an additional:

- $\pm 1.0\%$ O₂,
- $\pm 10\%$ of reading for CO, CO, NO, NO₂ and SO₂.

| Measurement | Range | Resolution | Accuracy | Response Time |
|--------------------|-----------------|------------|--|------------------|
| O ₂ | 0 to 20.9% | 0.1% | $\pm 0.3\%$ O ₂ (<i>on flue gas</i>) | T90 < 20 seconds |
| CO-H ₂ | 0 to 10,000 ppm | 1 ppm | ± 10 ppm (<i>0 to 200</i>) $\pm 5\%$ reading (<i>201 to 2,000</i>) $\pm 10\%$ reading (<i>2,001 to 10,000</i>) | T90 < 40 seconds |
| CO _{HIGH} | 0 to 40,000 ppm | 10 ppm | ± 10 ppm (<i>0 to 100</i>) $\pm 10\%$ reading (<i>101 to 40,000</i>) | T90 < 75 seconds |
| NO | 0 to 3,000 ppm | 1 ppm | ± 3 ppm (<i>0 to 50</i>) $\pm 5\%$ (<i>51 to 2000</i>) $\pm 10\%$ reading (<i>> 2000</i>) | T90 < 30 seconds |
| NO ₂ | 0 to 500 ppm | 1 ppm | ± 3 ppm (<i>0 to 50</i>) $\pm 5\%$ (<i>51 to 500</i>) | T90 < 40 seconds |
| SO ₂ | 0 to 5,000 ppm | 1 ppm | ± 10 ppm (<i>0 to 200</i>) $\pm 5\%$ reading (<i>201 to 2,000</i>) $\pm 10\%$ reading (<i>2,001 to 5,000</i>) | T90 < 30 seconds |

| Measurement | Range | Resolution | Accuracy | Response Time |
|---|-------------------------------------|-----------------------|--|------------------|
| Ambient Temperature | -20° to 537 C (-4° to 999° F) | 0.1° C (0.1° F) | ±1° C (0° to 100° C) | T90 < 70 seconds |
| Stack Temperature | -20° to 1200° C (-4° to 2192° F) | 1° C (1° F) | ±2° C (0° to 124° C) ±3° C (125° to 249° C) ±4° C (250° to 400° C) | T90 < 50 seconds |
| Differential Temperature | ±600° C (±1112° F) | 0.1° C (0.1° F) | N/A | N/A |
| Pressure / Differential Pressure | ±179 mB (±72 inwc) | 0.01 mB (0.01inwc) | ±0.03 mB (-1 to 1 mB) ±0.05 mB (-2.5 to 2.5 mB) ±3% reading (-100 to 100 mB) | N/A |
| Flow | 0 to 1 LPM | 0.05 LPM | ±0.1 LPM | N/A |

6.1.4 Calculated Readings

| Calculation | Range | Resolution | Instrument Version |
|---|----------------------------------|------------|--------------------|
| Efficiency (HHV) | 0.1 to 100% | 0.1% | North American |
| CO₂ (Dry Basis) | 0.1 to a fuel dependent max in % | 0.1% | North American |
| NO_x | 0 to 3,500 ppm | 1 ppm | North American |
| CO Referenced to O₂ | 0 to 9,999 ppm | 1 ppm | North American |
| NO Referenced to O₂ | 0 to 9,999 ppm | 1 ppm | North American |
| NO₂ Referenced to O₂ | 0 to 9,999 ppm | 1 ppm | North American |
| NO_x Referenced to O₂ | 0 to 9,999 ppm | 1 ppm | North American |
| SO₂ Referenced to O₂ | 0 to 9,999 ppm | 1 ppm | North American |
| Excess Air | 1 to 250% | 1% | North American |

6.2 PCA® Reporting Software

A PC with PCA® Reporting Software (PRS) installed can set, edit and transfer the following data:

- Live Data Reporting
- Time and Date
- Custom Fuels
- Test ID
- Username
- Logo / Graphic
- Instrument Setup
- Calibration Password
- B-Smart® Code
- Test Records
- Firmware Updates

6.2.1 Downloading Stored Data to a Computer

The combustion test data which was stored in either the analyzer's Memory Directory can be downloaded to a computer using the PRS and USB cable that are supplied with the analyzer.

The downloaded data is stored on the computer's hard drive – or removable media of the operator's choosing – as a comma-separated-value ASCII text file with a CSV extension. This type of file can be opened by most spreadsheet applications for analysis.

Minimum Computer Requirements for PCA® Reporting Software

| Category | Minimum Requirement |
|-------------------------|---|
| Operating System | Windows 7, 8, 10 |
| Access Port | USB port (USB 1.1, 2.0, or 3.0) |
| Hard Drive Space | Software: 205MB for the PCA® Reporting Software |
| | Data: 350KB for each downloaded file |

6.2.2 Importing Saved Data

Data which has been recovered and saved as an ASCII text file with a CSV extension, as described above, can be opened in most spreadsheet applications (*Microsoft Excel, Google Sheets, etc.*). If the application does not recognize the CSV file extension, then refer to the spreadsheet's documentation for information on how to manually import comma-delimited text files.

The table below contains listings and descriptions of the 32 data fields that are downloaded with each data record. Note that for sensors that are not installed, all related data fields for those sensors will be marked as “***”. For example, if the analyzer does not contain an SO₂ sensor, then “***” will appear in data fields 23 and 24.

Downloaded Data Fields

| Field | Column Name | Data Name or Value |
|-------|---------------------------------------|--|
| 1 | Date | Date of Test (MM/DD/YY) |
| 2 | Time | Time of Test (12-Hour Format) |
| 3 | Folder | Information Input by User |
| 4 | Subfolder | Information Input by User |
| 5 | Fuel | Fuel Name |
| 6 | % O ₂ | Oxygen Level |
| 7 | CO | Carbon Monoxide Level (See Field 27) |
| 8 | ppm CO (O ₂) | Carbon Monoxide Reference to a % of O ₂ (See Field 24) |
| 9 | % Efficiency | Combustion Efficiency |
| 10 | % CO ₂ | Carbon Dioxide Level |
| 11 | % EA | Excess Air |
| 12 | TStk | Stack Temperature |
| 13 | TAir | Primary / Ambient Air Temperature |
| 14 | Delta-T | Differential Temperature Value |
| 15 | TempUnit | Temperature Units |
| 16 | NO | Nitric Oxide Level (See Field 27) |
| 17 | ppm NO (O ₂) | Nitric Oxide Level Referenced to a % of O ₂ (See Field 25) |
| 18 | NO ₂ | Nitric Dioxide Level (See Field 27) |
| 19 | ppm NO ₂ (O ₂) | Nitric Dioxide Level Referenced to a % of O ₂ (See Field 25) |
| 20 | NO _x | Nitrogen Oxide (NO + NO ₂ , See Field 27) |
| 21 | ppm NO _x (O ₂) | Nitrogen Oxide Level as Referenced to a % of O ₂ (See Field 25) |
| 22 | SO ₂ | Sulfur Dioxide (See Field 27) |
| 23 | ppm SO ₂ (O ₂) | Sulfur Dioxide Level Referenced to a % of O ₂ (See Field 26) |
| 24 | CO_O ₂ Ref | % O ₂ Reference for CO |
| 25 | NO _x _O ₂ Ref | % O ₂ Reference for NO _x |
| 26 | SO ₂ _O ₂ Ref | % O ₂ Reference for SO ₂ |
| 27 | Pollution Units | Pollution Units of Measure ⁽¹⁾ |
| 28 | Pressure | Pressure (Draft) Value |
| 29 | Pressure Units | Pressure Units of Measure ⁽²⁾ |

⁽¹⁾ Pollution units as selected (Section 3.2.1).

⁽²⁾ Pressure units as selected (Section 3.3.1).

6.3 PCA® 400 App

To download the PCA® 400 App, visit [_____](#). The companion smartphone application allows users to perform a variety of functions without needing to be in front of their analyzer:

- Control the PCA® 400 (*start and stop the analyzer via Bluetooth®*)
- View real-time measurements
- Generate customizable reports (*reports may be shared via available email / cloud services*)

Minimum Computer Requirements for PCA® Reporting Software

| Category | Minimum Requirement |
|-------------------------|---|
| Operating System | Android 5.0 and later iOS 10 and later |
| Communications | Bluetooth® 4.0 or later (<i>not compatible with Bluetooth® 3.0 or Bluetooth® Classic</i>) |
| Hard Drive Space | Android: 50MB (<i>for the application only</i>) |
| | iOS: 30MB (<i>for the application only</i>) |

7. Parts & Accessories

| | | |
|-----|--------------------------------|----|
| 7.1 | Part Numbers..... | 70 |
| 7.2 | Service Center Locations | 72 |

7.1 Part Numbers

| Product | Description / Part Number | |
|--|---------------------------|--|
| Accessories | | |
| Active Sample Conditioner Kit | Description: | The Active Sample Conditioner extracts water vapor from samples, allowing the PCA® 400 to accurately read levels of NO _x or SO ₂ . |
| | P/N: | 0024-8558 |
| IrDA + Bluetooth® Printer | Description: | The IrDA + Bluetooth® Printer allows technicians to print reports directly from their analyzer without a wired connection. |
| | P/N: | 0024-1680 |
| Printer Paper <i>(contains 5 rolls of paper)</i> | P/N: | 0024-1310 |
| Tru Spot® Smoke Tester | Description: | The True Spot® Smoke Tester helps technicians quickly check smoke levels in flue gases. |
| | P/N: | 0021-7006 |
| PCA® 400 Carrying Case | P/N: | 0024-0865 |
| Flue Plugs, 5/16" <i>(contains 50 metal plugs)</i> | P/N: | 0024-8557 |
| Sample Line & Probe Assembly | | |
| Probe, 12" | P/N: | 0024-3231 |
| Probe, 24" | P/N: | 0024-3232 |
| Probe, 36" | P/N: | 0024-3233 |

| Product | | Description / Part Number |
|---|--------------|---|
| Sample Line & Probe Assembly (continued) | | |
| Buna-N Sample Line Assembly with Water Trap, 7.5' | Description: | Buna-N tubing is recommended for applications which do not require accurate NO ₂ or SO ₂ measurement. |
| | P/N: | 0024-3234 |
| Buna-N Sample Line Assembly with Water Trap, 15' | P/N: | 0024-3235 |
| Viton® Sample Line Assembly with Water Trap, 7.5' | Description: | Viton® tubing is recommended for applications which require accurate NO ₂ or SO ₂ measurement. |
| | P/N: | 0024-3236 |
| Viton® Sample Line Assembly with Water Trap, 15' | P/N: | 0024-3237 |
| Sensors | | |
| O ₂ Sensor | P/N: | 0024-1652 |
| CO Sensor (<i>B-Smart® Pre-calibrated Sensor</i>) | P/N: | 0024-1687 |
| CO Sensor (<i>Not Calibrated</i>) | P/N: | 0024-1660 |
| CO _{HIGH} Sensor (<i>B-Smart® Pre-calibrated Sensor</i>) | P/N: | 0024-1542 |
| CO _{HIGH} Sensor (<i>Not Calibrated</i>) | P/N: | 0024-0997 |
| SO ₂ Sensor (<i>B-Smart® Pre-calibrated Sensor</i>) | P/N: | 0024-1543 |
| SO ₂ Sensor (<i>Not Calibrated</i>) | P/N: | 0024-0998 |
| NO ₂ Sensor (<i>B-Smart® Pre-calibrated Sensor</i>) | P/N: | 0024-1544 |
| NO ₂ Sensor (<i>Not Calibrated</i>) | P/N: | 0024-1027 |
| NO Sensor (<i>B-Smart® Pre-calibrated Sensor</i>) | P/N: | 0024-1691 |
| NO Sensor (<i>Not Calibrated</i>) | P/N: | 0024-0881 |
| Filters / Gaskets / Caps | | |
| Water Trap Kit | P/N: | 0019-3265 |
| Water Trap Filters (<i>contains 3 filters</i>) | P/N: | 0007-1644 |
| Gasket | P/N: | 0024-1745 |
| Vinyl Cap | P/N: | 0005-4766 |

| Product | Description / Part Number | |
|--|---------------------------|-----------|
| Calibration Gases | | |
| 500 ppm CO in Air | P/N: | 0024-0492 |
| 1000 ppm CO/H ₂ in Nitrogen Balance | P/N: | 0024-0794 |
| 100 ppm NO in Nitrogen Balance | P/N: | 0024-1697 |
| 100 ppm NO ₂ in Nitrogen Balance | P/N: | 0024-1157 |
| 100 ppm SO ₂ in Nitrogen Balance | P/N: | 0024-1158 |
| Calibration Kit | P/N: | 0024-7059 |
| Power Supply | | |
| NO Bias Battery | P/N: | 0204-0020 |
| Lithium-Ion Battery Pack | P/N: | 0024-1664 |
| USB Communications / Power Cable | P/N: | 0104-4034 |
| Universal AC Power Adapter | P/N: | 0024-1681 |