



Frontier™ Centrifuge FC5513 Instruction Manual



Front and rear view of the centrifuge FC5513

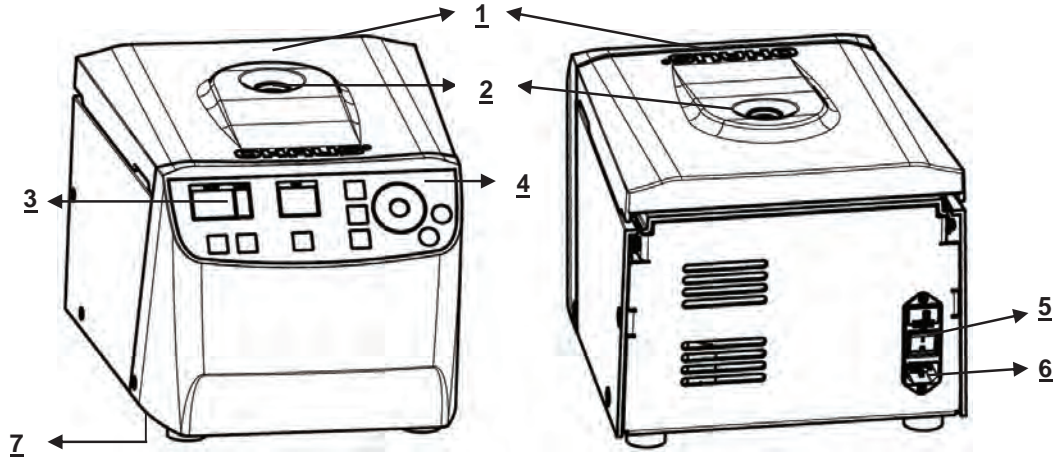

Figure.1

1 Centrifuge Lid	2 Rotor Window
3 Display	4 Function Label
5 Main Power Switch	6 Power Connection
7 Emergency Release	

Function Label

Function Label for FC5513

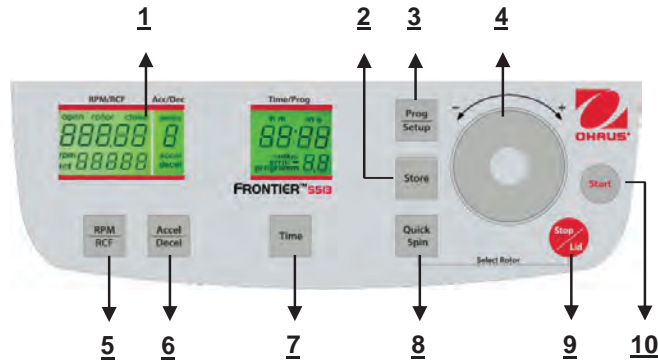

Figure.2

1. LCD Display	2. Store setup information
3. Program setup model	4. Adjusting Dial: Change the number
5. RPM/RCF model and select	6. Acceleration/Deceleration intensity model and select
7. Time setup model	8. Short/quick spin centrifugation
9. Stop centrifugation / Release lid	10. Start centrifugation

LCD Display

The following picture shows the individual elements of the LCD-display.

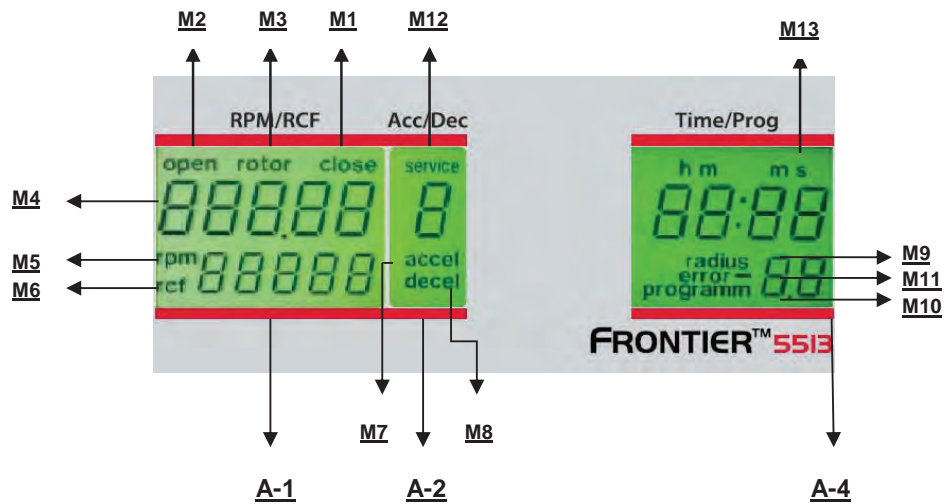

Figure.3

Display fields:

- A-1 Display fields – "RPM/RCF"
- A-2 Display fields – "Acc/Dec" "Service"
- A-3 Display fields – "Time/Prog"

Messages/logos of the display fields

M1	"close"	M2	"open"	M3	"rotor"
M4	"rotor no"	M5	"rpm"	M6	"rcf"
M7	"accel"	M8	"decel"	M9	"radius"
M10	"program"	M11	"error"	M12	"service"
M13	"h m s"				

Rotor No. Table

Rotor No. display	Order No.	Capacity	Fit model
01	30472301	24 x 1.5 ml / 2.0 ml	FC5513
02	30472302	24 x 1.5 ml / 2.0 ml sealable	FC5513
03	30472303	18x2ml Spin Column Kit	FC5513
04	30472304	24 Hematocrit	FC5513

TABLE OF CONTENTS

1. INTRODUCTION	1
1.1 Description	1
1.2 Features	1
1.3 Definition of Signal Warnings and Symbols.....	1
1.4 Safety Precautions.....	2
1.4.1 User.....	2
1.4.2 Rotor and accessories	2
1.4.3 Measures for your protection	2
1.4.4 Exclude the following environmental influences	2
1.4.5 Measures for operational safety	3
1.4.6 Danger and precautions	3
1.4.7 Abbreviations used in this manual	3
2. INSTALLATION	4
2.1 Unpacking	4
2.1.1 Delivery package for Frontier™ FC5513	4
2.2 Selecting the Location	4
2.3 Installation.....	4
2.4 Safety precautions during operation	4
3. OPERATION	5
3.1 Mounting and loading rotor	5
3.1.1 Installation of rotors.....	5
3.1.2 Loading angle rotors	6
3.1.3 Loading and overloading of rotors	6
3.1.4 Removing the rotor	6
3.2 Lid control	7
3.2.1 Lid open	7
3.2.2 Lid lock.....	8
3.3 Preselection	8
3.3.1 Preselection of speed / RCF-value	8
3.3.2 Preselection of running time	8
3.3.3 Preselection of brake intensity and acceleration	9
3.4 Radius correction	9
3.5 Program	10
3.5.1 Storage of programs	10
3.5.2 Recall of stored programs.....	11
3.5.3 Leaving program mode	11
3.6 Starting and stopping the centrifuge	12
3.6.1 Starting the centrifuge.....	12
3.6.2 The "STOP/Lid" key	12
3.7 Imbalance detection.....	12

4. SETTING	13
4.1 Basic adjustments	13
4.1.1 Change the type of rotor	13
4.1.2 Access to mode "Operating Data"	13
4.1.3 Signal turn on / off	15
4.1.4 Volume pre-selection of sound signal	15
4.1.5 Song selection for sound signal - end of run	15
4.1.6 Keyboard sound turn on / off	16
4.1.7 Sleep Mode On / Off	16
4.1.8 Call up operating data	16
5. MAINTENANCE	17
5.1 Maintenance and cleaning	17
5.1.1 General Care	17
5.1.2 Cleaning and disinfection of the unit	18
5.1.3 Cleaning and disinfection of the rotor	18
5.1.4 Disinfection of aluminum rotors	18
5.1.5 Disinfection of PP-rotors	18
5.1.6 Glass breakage	19
6. TROUBLESHOOTING	19
6.1 Error message: Cause / Solution	19
6.2 Survey of possible error messages and their solutions	19
6.2.1 Lid release during power failure (Emergency Lid Release)	19
6.2.2 Description of the error message system	20
7. RECEIPT OF CENTRIFUGES TO REPAIR	20
8. TRANSPORT AND STORAGE	20
8.1 Transport	20
8.2 Storage	20
9. TECHNICAL DATA	21
9.1 Specifications	21
9.1.1 Centrifuge FC5513	21
9.2 Drawings and dimensions	22
10. ORDER INFORMATION	23
11. COMPLIANCE	23
12. APPENDIX	24
12.1 Table 1: Permissible net weight	24
12.2 Table 2: Max. speed and RCF-values for permissible rotors	24
12.3 Table 3: Acceleration and deceleration times	24
12.4 Table 4: Error messages	25
12.5 Table 5 (part 1): Radius correction	26
12.6 Table 6: Symbols- / Abbreviations	26
12.7 Table 7: Redemption form / Decontamination certificate	27

1. INTRODUCTION

1.1 Description

Thank you for choosing this OHAUS product.

All symbols indicate safety instructions and points to potential dangerous situations. Please read the manual completely before using the Frontier™ FC5513 to avoid incorrect operation.

Frontier™ FC5513 centrifuge was designed for the separation of materials or mixtures with different density.

1.2 Features

The Frontier™ FC5513 centrifuge offers many practical features such as:

- High performance, reach up to 17,317 x g
- Rotor options for microtubes, spin column kit, and capillaries
- Remarkably small footprint to save invaluable benchtop space
- Ergonomic touch-wheel makes parameter adjustment fun
- Splash-proof front panel can endure sample spill and is easy to clean
- Distinct Intuitive control panel interface can be operated by one hand
- All key parameters are visible at all times

1.3 Definition of Signal Warnings and Symbols

Safety notes are marked with signal words and warning symbols. These show safety issues and warnings. Ignoring the safety notes may lead to personal injury, damage to the instrument, malfunctions and false results.

The degree of danger is a part of a safety note and distinguishes the possible results of non-observance from each other.

Signal Words

DANGER	Will lead to severe injuries or death if not avoided.
WARNING	For a hazardous situation with medium risk, possibly resulting in injuries or death if not avoided.
CAUTION	For a hazardous situation with low risk, resulting in damage to the device or the property or in loss of data, or injuries if not avoided.
ATTENTION	For important information about the product. May lead to equipment damage if not avoided
NOTE	For useful information about the product

Warning Symbols



General Hazard



Electrical Shock Hazard



Alternating Current



Biohazard



Explosion



Crushing

Warning and information signs on the surface of centrifuge

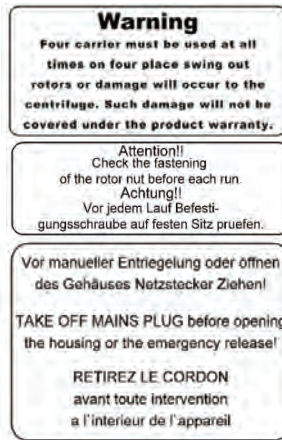

Four carrier must be used at all times on four place swing out rotors or damage will occur to the centrifuge. Such damage will not be covered under the product warranty.

Attention! Check the fastening of the rotor nut before each run.

Take off mains plug before opening the housing or the emergency release.

1.4 Safety Precautions

1.4.1 User

OHAUS centrifuges are intended exclusively for indoor use and for use by qualified personnel. This device may only be operated by trained specialist staff. They must have carefully read the operating manual and be familiar with the function of the device.

1.4.2 Rotor and accessories

Only OHAUS original rotors and accessories shall be used. Any other use or intended use is considered improper. OHAUS is not liable for damage resulting from improper use.



CAUTION:

Read all safety warnings before installing, making connections, or servicing this equipment. Failure to comply with these warnings could result in personal injury and/or property damage. Retain instructions for future reference.

1.4.3 Measures for your protection



WARNING: Never work in an environment subject to explosion hazards! The housing of the instrument is not gas tight. (Explosion hazard due to spark formation, corrosion caused by the ingress of gases)



WARNING: When using chemicals and solvents, comply with the instructions of the producer and the general lab safety rules.



WARNING: The centrifuge is not sealed. Use suitable protection measures when using the centrifuge for infectious and pathogenic samples. Follow appropriate safety precautions when handling these samples.

1.4.4 Exclude the following environmental influences

- Powerful vibrations
- Direct sunlight
- Atmospheric humidity greater than 80%
- Corrosive gases present
- Temperatures below 2 °C and above 35 °C
- Powerful electric or magnetic fields:



WARNING:

Electrical shock hazards exist within the housing. The housing should only be opened by authorized and qualified personnel. Remove all power connections to the unit before opening.

1.4.5 Measures for operational safety

- Do not unscrew the two halves of the housing
- Dry off any liquid spills immediately! The instrument is not watertight
- Verify that the equipment's input voltage range and plug type are compatible with the local power supply.
- Only connect the power cord to a properly grounded power receptacle.
- Only use a power cord with a rating that exceeds the specifications on the equipment label.
- Do not position the equipment such that it is difficult to disconnect the power cord from the power receptacle.
- Make sure that the power cord does not pose a potential obstacle or tripping hazard.
- The equipment is for indoor use only. Use the equipment only in dry locations.
- Use only approved accessories.
- Operate the equipment only under ambient conditions specified in these instructions.
- Disconnect the equipment from the power supply when cleaning.
- Do not operate the equipment in hazardous or unstable environments.
- Service should only be performed by authorized personnel.

1.4.6 Danger and precautions

To protect people and environment the following precautions should be observed:

- During centrifugation, the presences of people are prohibited within 30 cm around the centrifuge according to the regulations of EN 61010-2-020.
- FC5513 is not explosion-proof and must therefore not be operated in explosion-endangered areas or locations. Centrifugation of flammable, explosive, radioactive, or such substances, which chemically react with high energy, is strictly prohibited. The final decision on the risks associated with the use of such substances is the responsibility of the user of the centrifuge.
- Never spin toxic or pathogenic material without adequate safety precautions, i.e. centrifugation of buckets / tubes with missing or defective hermetic sealing is strictly prohibited. The user is obliged to perform appropriate disinfection procedures in case dangerous substances have contaminated the centrifuge and or its accessories. When centrifuging infectious substances, always pay attention to the general laboratory precautions. If necessary, contact your safety officer!
- It is prohibited to run the centrifuge with rotors other than listed for this unit.
- Under no circumstances open the lid of the centrifuge while the rotor is still running or rotating with a speed of > 2m/s.

1.4.7 Abbreviations used in this manual

Symbol/Abbreviations	Unit	Description
RPM	[min ⁻¹] rpm	revolutions per minute
RCF	[x g]	relative centrifugal force
PCR		PCR Polymerase chain reaction
PP	-	Polypropylene
PC	-	Polycarbonate
accel	-	acceleration
decel	-	deceleration
prog	-	program

2. INSTALLATION

2.1 Unpacking

Carefully remove your centrifuge and each of its components from the package. The included components vary depending on the centrifuge model (see table below). Save the packaging to ensure safe storage and transport. The instruction manual must always be kept with the centrifuge!

Rotor(s) / Accessories will be packed separately.

2.1.1 Delivery package for Frontier™ FC5513

Quantity	Description
1	Centrifuge FC5513
1	Power Cable
1	Warranty Card
1	Instruction Manual
1	Rotor Key

2.2 Selecting the Location



ATTENTION:

Avoid excessive vibrations, heat sources, air current, or rapid temperature changes.

- The centrifuge should be installed on an even, solid and level surface, if possible on a laboratory cabinet / table or some other solid vibration free surface.
- During centrifugation, the centrifuge must be placed in a way, that there is a minimum space of 30 cm on each side of the unit, according to the standards EN 61010-2-020.
- Do not place the centrifuge next to a window or a heater, where it could be exposed to excessive heat, as the performance of the unit is based on an ambient temperature of 23 °C.

2.3 Installation

Follow these steps:

- Check whether the power supply corresponds with the one specified on the manufacturer's rating label, which is located on the rear panel.
- The line voltage circuit breaker is max. 10 A (type K) slow release for commonly used instruments.
- In case of emergency, there must be an emergency switch off installed outside the room in order to disconnect the power supply from the unit.
- Connect the centrifuge to a grounded power receptacle.
- Turn the instrument on, by using the mains power switch.
- Open the lid by using the Stop / Lid button.
- Remove the transport securing device of the motor.

2.4 Safety precautions during operation

- Do not operate the centrifuge in case it is not installed correctly.
- Do not lean on the centrifuge during operation.
- Do not stay within the 30 cm clearance envelope longer than necessary for operational reasons.
- Do not place any potentially hazardous materials within the 30 cm clearance envelope.
- Do not operate the centrifuge when disassembled (e.g. without housing).
- Do not run the centrifuge when mechanical or electrical components have been tampered with.
- Do not use accessories such as rotors and buckets, which are not exclusively approved by OHAUS Corporation, except commercially available centrifuge tubes made of glass or plastic.
- Do not spin extremely corrosive substances, as they may damage or weaken the materials.
- Do not operate the centrifuge with rotors or buckets, which show any signs of corrosion or mechanical damage.

The manufacturer is responsible for safety and reliability of the centrifuge, only if:

- The unit is operated in accordance with this instruction manual.

- Modifications, repairs or other adjustments are performed by authorized personnel and the electrical installation complies with the relevant electrical codes.

3. OPERATION

3.1 Mounting and loading rotor

3.1.1 Installation of rotors

For FC5513 centrifuge packaged with rotor already installed, these following steps are not necessary.

Clean the drive shaft as well as the collet with a clean, grease-free piece of cloth. Place the rotor onto the drive shaft. (See figure below). Take care that the rotor is fully installed onto the motor shaft.



Motor shaft and chamber

Figure.10



Nut for Rotor

Figure. 11-1

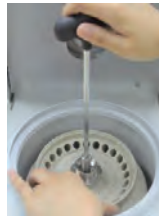

Tool for rotor

Figure. 11-2



Snap-on lid

Figure. 11-3



Screw-on lid

Figure. 11-4



Snap-on lid

Figure. 11-5



Screw-on lid

Figure 11-6

Hold the rotor with one hand and secure the rotor to the shaft by turning the fixing nut clockwise. Tighten the fixing nut with enclosed rotor key (See figures 11)

Rotor with hermetical sealed lid has to be locked with provided rotor key. Therefore hold the rotor with one hand and secure the rotor by turning the fixing nut clockwise (see Figure 11)

We will provide a tool for none-nut rotor with centrifuge, the tool for nut-rotor will be provided with rotor.



ATTENTION:

Check that the fixing screw is properly installed before each run. (See figure 9)

Do not operate the centrifuge with rotors or buckets which show any signs of corrosion or mechanical damage.

Do not operate with extremely corrosive substances, which could damage the rotor, buckets and materials.

In case of any questions, please contact the manufacturer!

3.1.2 Loading angle rotors

Rotors must be loaded symmetrically and with equal weight (See figure below). The adapter may only be loaded with the appropriate vessels. The weight differences between the filled vessels should be kept as low as possible. Therefore we recommend weighing them with a balance. This reduces the wear of the drive and the acoustic operating noise.

On each rotor, the maximum load per hole is stated.



Figure.12 WRONG



Figure.13 CORRECT (12 tubes)

3.1.3 Loading and overloading of rotors

All approved rotors are listed with their maximum speed and maximum filling weight in "**table 2 permissible net weight**" (See APPENDIX).

The maximum load permitted for a rotor, which is determined by the manufacturer, as well as the maximum speed allowed for this rotor (See label on rotor), must not be exceeded. The liquids the rotors are loaded with, should have a maximum homogeneous density of 1.2 g/ml or less when the rotor is running at maximum speed.

In order to spin liquids with a higher density, the speed has to be reduced according to the following formula:

$$\text{Reduced speed } n_{\text{red}} = \sqrt{\frac{1,2}{\text{higher density}}} \times \text{max. speed } (n_{\text{max}}) \text{ of the rotor}$$

Example:

$$n_{\text{red}} = \sqrt{\frac{1,2}{1,7}} \times 4.000 = 3.360 \text{ rpm}$$

If in case of any questions, please contact the manufacturer!

3.1.4 Removing the rotor

Untighten the rotor fixing nut completely (screw over the stiff point) and lift the rotor vertical out of the centrifuge. (See figure 8 and 9)

The power switch is located on the back side of the centrifuge (See figure 14).



Figure. 14: Power Switch

⚠ATTENTION:

After turning on the power switch, open the centrifuge lid first, before starting the centrifuge.

3.2 Lid control

3.2.1 Lid open

Before the run, when the lid of the centrifuge is closed, the word "close" (M1) appears in the display "**RPM | RCF**" (A-1). Additionally, if there is a rotor in the centrifuge, the word "rotor"(M3) appears as well as the code number of the respective rotor, which is in the centrifuge system "71" (M4). If there is no rotor in the centrifuge, the word "rotor" (M3) flashes and additionally the word "no" (M4) appears. By pressing the key "Stop/Lid" (9) you can release the lid of the centrifuge. As soon as the lid is completely released, the word "open" (M2) appears. Now you can open the lid of the centrifuge.

Please refer to figure 15 below for reference.

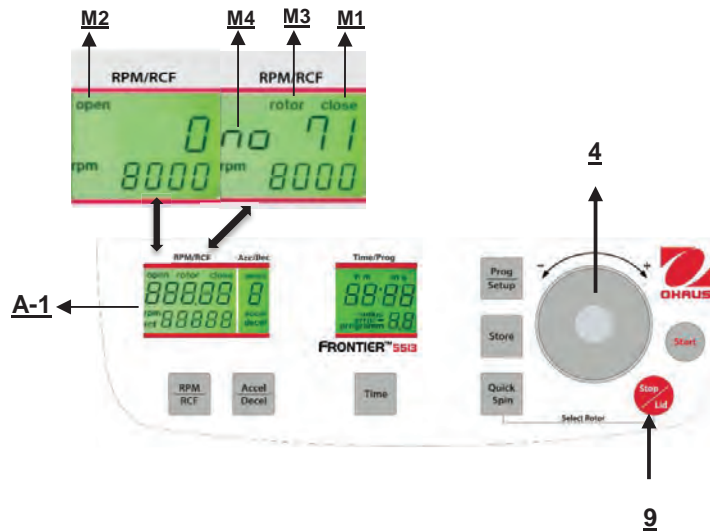

Figure. 15

During the run you can call up the rotor type at any time by pressing the key "Stop/Lid" (9).

3.2.2 Lid lock

The lid should only be put down slightly. An lid lock closes the lid, at the same time the word **"open"** (M2) disappears (refer to figure 15).

As a sign that the centrifuge is ready for starting, in the display **"RPM | RCF"** (A-1) the word **"close"** (M1) appears. Simultaneously the word **"rotor"** (M3) is displayed, as well as the code number of the rotor, which is in the centrifuge system, **"no 71"** (M4). With that, all rotor specific data, like e. g. max. speed, acceleration etc., are adopted.



ATTENTION:

Don't grip your fingers between lid and device or locking mechanism when closing the lid!
Before closing the lid, please check if the rotor is tightened.

3.3 Preselection

3.3.1 Preselection of speed / RCF-value

This pre-selection is activated through the key **"RPM/RCF"** (5) (refer to figure 16 below). By pressing the key once the word **"rpm"** (M5) flashes. By pressing the key twice the pre-selection of the centrifugal forces can be selected. Then the flashing word **"rcf"** (M6) appears. You can set the desired values with the adjusting dial (4). In the display (A-1) the regulated value is shown permanently, before, during and after the run.

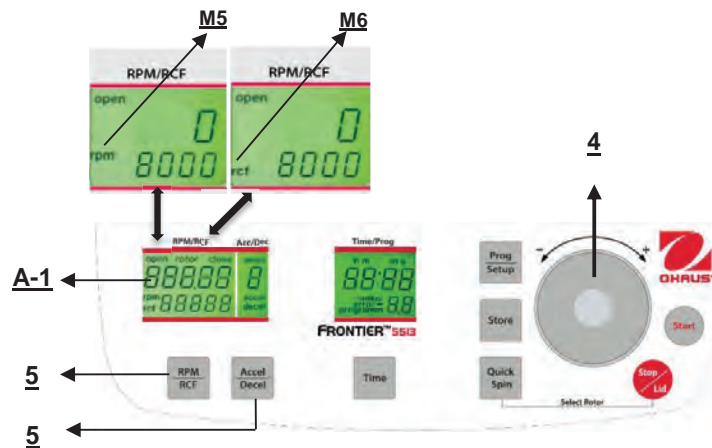

Figure. 16

As long as no rotor is inserted, the speed is adjustable between 200 rpm and maximum revolution of the centrifuge. If there is a rotor in the centrifuge the speed can only be pre-selected until the maximum permissible revolution of that rotor. It is the same with the pre-selection of the RCF-value. The setting range is between 20 x g and the maximum permissible centrifugal force of the rotor.

See **"Table 4: max. speed and RCF-values for permissible rotor"** (See APPENDIX). All important values are listed there.



ATTENTION:

Please also check the maximum permissible revolutions of your test tubes with the manufacturer.

3.3.2 Preselection of running time

The running time can be pre-selected in three different ranges from 10 seconds up to 99 hours 59 minutes.

1. Range from 10 seconds up to 59 minutes 50 seconds in steps of 10 seconds
2. Range from 1 hour up to 99 hours 59 minutes in steps of 1 minutes
3. The continuous run **"cont"**, which can be interrupted by the key **"Stop/Lid"** (9) (refer to figure 17).

The running time can be pre-selected with the lid open or closed.

To activate the setting of the running time press the key **"Time"** (7).

In the display **"Time/Prog"** (A-4) flashes the indication **"m : s"** or **"h : m"**, depending on the previous setting.

To set the desired value, use the adjusting dial (4). After exceeding 59 min 50 sec the indication changes automatically into **"h : m"**. After exceeding 99 hours 59 min the word **"cont"** appears in the display **"Time/Prog"** (A-4). That continuous run can only be interrupted by pressing the key **"Stop/Lid"** (9). The time countdown starts as soon as the set speed is reached.

The display always shows the remaining running time. (See figure 17)

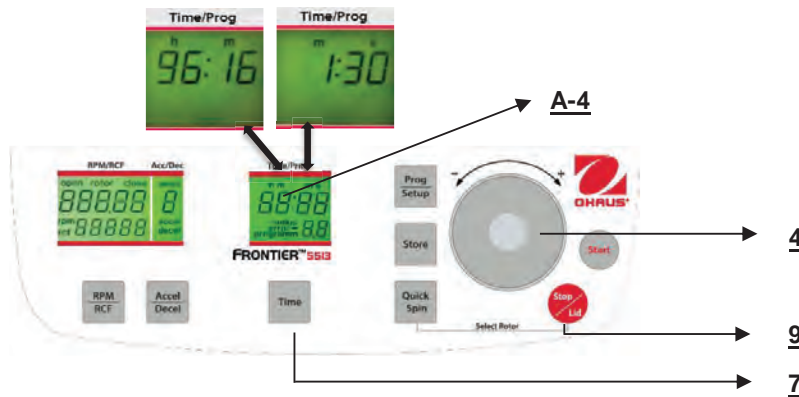

Figure. 17

3.3.3 Preselection of brake intensity and acceleration

This function is activated through the key "Accel/Decel" (6) (refer to figure18).

By pressing the key once the word "accel" (M7) flashes in the display "Acc/Dec" (A-2). The desired acceleration can be pre-selected by the adjusting dial (4). The value 0 is equivalent to the lowest and the value 9 to the highest acceleration.

By pressing the key "Accel/Decel" (6) twice, the display "Acc/Dec" (A-2) indicates the word "decel"(M8). Now the desired brake intensity can be pre-selected by the adjusting dial (4). The value 9 is equivalent to the shortest and the value 0 to longest possible brake time.

See "**table 5: acceleration and deceleration times**" (APPENDIX). There the acceleration and deceleration times for the acceleration and deceleration stages 0 to 9 for permissible rotors are shown.

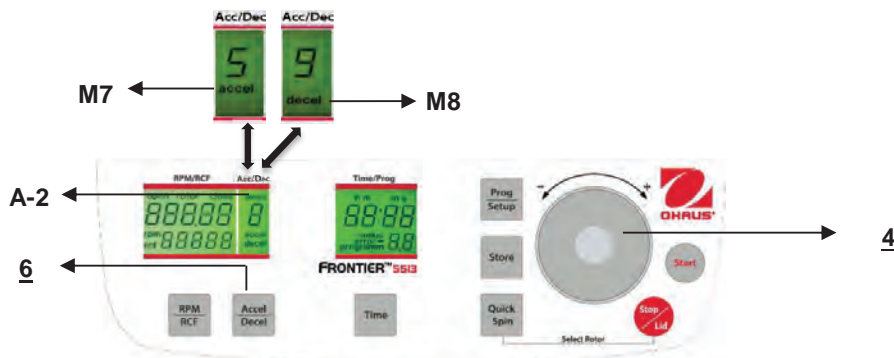

Figure. 18

3.4 Radius correction

If you use adapters or reducers it could change the centrifugal radius of the respective rotor. In that case you can correct the radius manually. Please proceed as follows:

Close the lid, then press the key "Time" (7) (refer to figure 19) and the key "Prog/Setup" (3) at the same time and hold them.

In the display "Time/Prog" (A-4) the word "radius" (M9) appears. By the adjusting dial (4) you can preselect the respective radius correction (See Table 7, APPENDIX) in steps of 0.1 cm. As soon as you have set a radius correction the word "radius" (M9) appears. This word will be visible until you put the radius correction back to 0 again.

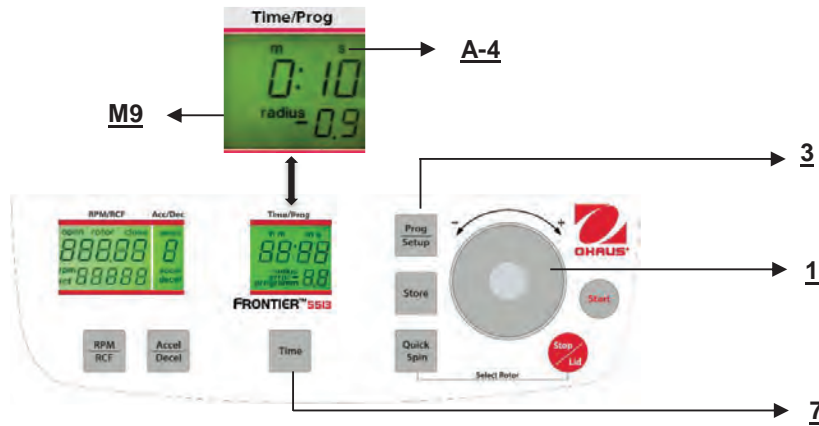

Figure. 19

3.5 Program

3.5.1 Storage of programs

You can store up to 99 runs with all relevant parameters, including the used rotors. You can use any free program number and call it up again.

Put the needed rotor into the centrifuge. By pressing the key "**Prog/Setup**" (3) in the display "**Time/Prog**" (A-4) the word "**programm**" (M10) appears. With the adjusting dial (4) you can chose the desired program number.

If a program number is already occupied, in the display "**RPM/RCF**" (A-1), the words "**rotor**" (M3) and "**xx**" (M4) will appear. In case of free program numbers, 0 appears.

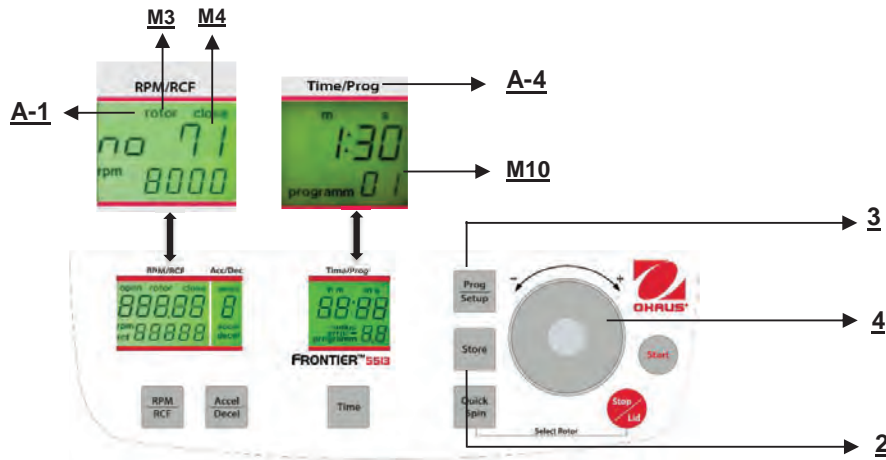

Figure. 20

Close the lid of the centrifuge. Now proceed as described previously to set all important run parameters. If the lid isn't closed when storing the program, in the display "**RPM/RCF**" (A-1), the words "**FirSt**" and "**CLOSE Lid**" (See figure 21) flashes alternately. If you want to start the run without storing the program, in the display "**RPM/RCF**" (A-1), the words "**First**" and "**PrESS StoreE**" (See figure 22) flashes alternately.

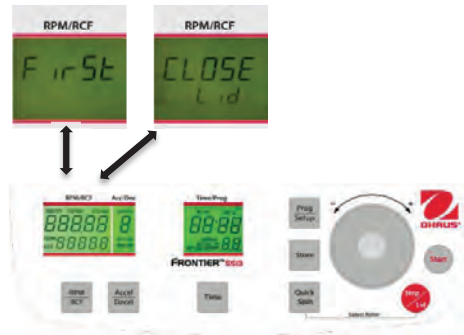

Figure. 21

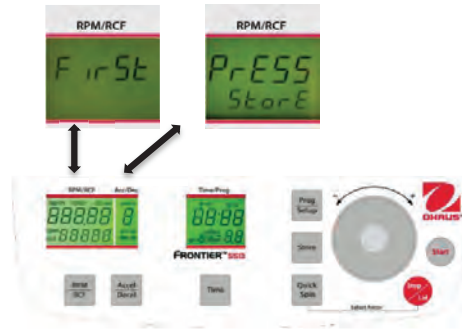

Figure. 22

For adaption of data press the key **"Store"** (2) (refer to figures 21 and 22) for approx. 1 second. If the program is stored correctly, the word **"StorE"** appears in the display **"RPM/RCF"** (A-1). As a result, the word **"programm"** (M10) disappears.

As soon as the key **"Store"** (2) is released, the word "programm xx" (M10) reappears – the (xx) stands for the chosen program location.

If all program numbers are occupied you can take an old number that is not necessary anymore and just put in the new parameters.

3.5.2 Recall of stored programs

To recall stored programs press the key **"Prog/Setup"** (3) (refer to figure 23) while the lid is already closed. Inside the display **"Time/Prog"** (A-4), **"programm -"**(M10) appears. The desired program number can be pre-selected with the adjusting dial (4).

In the respective displays the stored values for that program will appear.

If the wrong rotor is inside the centrifuge for the pre-selected program, in the display **"RPM/RCF"** (A-1), the word **"rotor"** (M3) flashes. At the same time the word **"FALSE"** and the stored rotor number **"xx"** (M4) will flashing by turns.

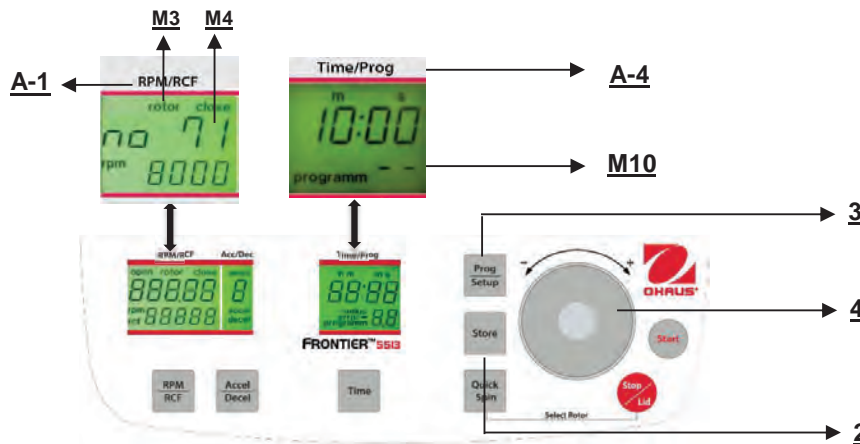

Figure. 23

3.5.3 Leaving program mode

To leave the program mode just press the key **"Prog/Setup"** (3) (refer to figure 23). Then inside the display **"Time/Prog"** (A-4) the word **"programm"**(M10) appears.

Set the display to **"programm--"** (M10) with the adjusting dial (4).

3.6 Starting and stopping the centrifuge

3.6.1 Starting the centrifuge

You can start the centrifuge either with the **"Start"** key (10) (refer to figure 24) or the **"Quick Spin"** key (8).

By the **"Start"** key (10) you can start stored runs or runs with manually pre-selected parameters.

When the respective pre-selected running time has ended the centrifuge will stop automatically.

By the **"Quick Spin"** key (8) you can start runs, which will last just a few seconds.

By pressing the **"Quick Spin"** key (8) the centrifuge accelerates up to the pre-selected revolution.

In the display **"Time/Prog"** (A-4) the passed running time is indicated from the date of pressing the **"Quick Spin"** key (8).

By releasing the **"Quick Spin"** key (8) the centrifuge stops and the running time is indicated until the opening of the lid.

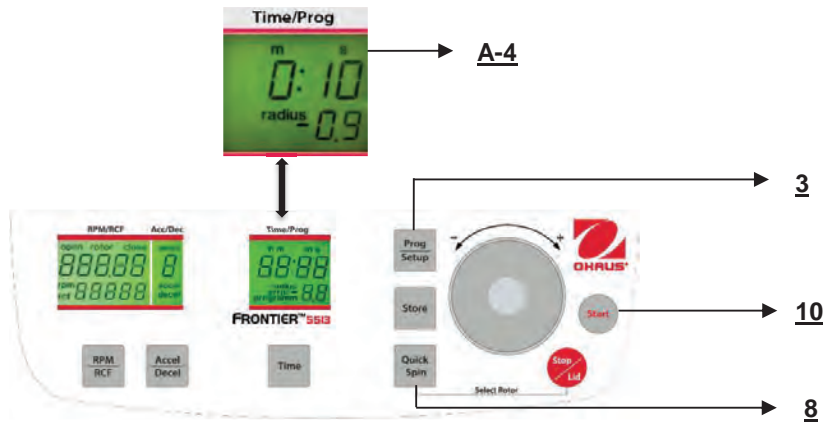

Figure. 24

3.6.2 The "STOP/Lid" key

By the **"Stop/Lid"** key (9) (See figure 25) you can interrupt the run at any time. After pressing the key the centrifuge decelerates with the respective pre-selected intensity down to stand still. After the rotor complete stopped, press the "Stop/Lid" key will open the lid.



Figure. 25

3.7 Imbalance detection

In case of the rotor not being equally loaded, the drive will turn off during acceleration. The rotor decelerates to stand still.

When in the display **"Time/Prog"** (A-4) the word **"error"** (M11) together with the number **"01"** appear, the weight difference of the samples is too large. Distribute the weight evenly.

Load the rotor as described in chapter 3.1.2 and 3.1.3.

When inside the display **"Time/Prog"** (A-4) the word **"error"** together with the number **"02"** (See figure 26) appear, it could be due to the following reason: The imbalance switch is defective.

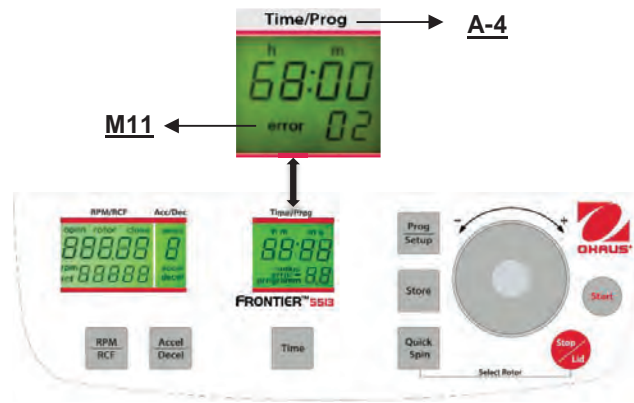

Figure. 26

4. SETTING

4.1 Basic adjustments

4.1.1 Change the type of rotor

Before the first operation and after each rotor change, you have to set the rotor type. You find each rotor type in the printed order number on the rotor.

Example:

Angle rotor order number: 30130871

Rotor Type on the display = 71

Turn on the centrifuge and open the lid. Now simultaneously press the keys "**Quick Spin**"(8) and "**Stop/Lid**"(9). In the display "**RPM/RCF**" the old rotor type no "**71**" appears. With the potentiometer you can now set the rotor type. To store the new setting please press the "**Start**" (10) key. Inside the display, "**Store**" appears as confirmation.

Now all important rotor parameters for the centrifuge are stored.



ATTENTION:

The set rotor type must always be the same as the actual rotor type used; otherwise the equipment might be damaged.

The rotor type can be checked during the run by pressing the key "**Quick Spin**"(8).

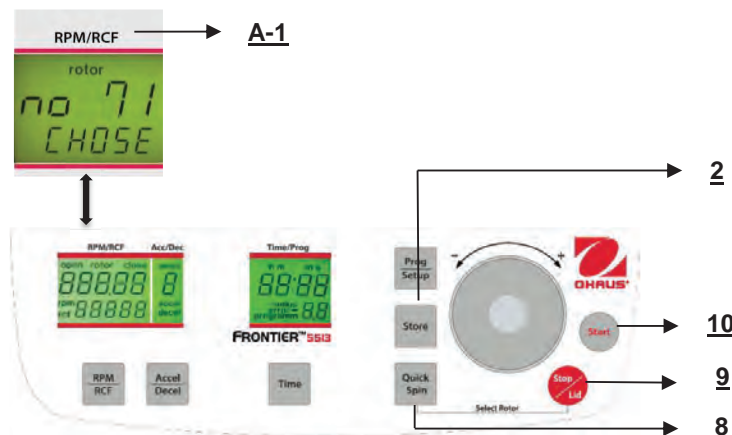

Figure. 27

4.1.2 Access to mode "Operating Data"

When using the centrifuge, the following parameters can be set:

- Acoustic signal turn on/off
- Keyboard sound turn on/off

- Volume pre-selection of sound signal
- Song selection of sound signal "**end of run**"
- Sleep Mode On / Off

The following operating data can be retrieved in this menu:

- Number of Starts
- Operating Hours of Centrifuge
- Operating Hours of Motor
- Software Version
- Error List
- Function of the Imbalance Switch
- Operation of Keyboard
- Hardware Version
- Intermediate Circuit Voltage in Volt
- Display Tests

While the centrifuge is turned off, press simultaneously the keys "**Time**"(7) and "**Stop/Lid**" (9) and turn on the main switch of the centrifuge. Now release both keys and as a result a display test is executed for approx. 5 seconds. All indicators will appear at the same time (See figure 28).

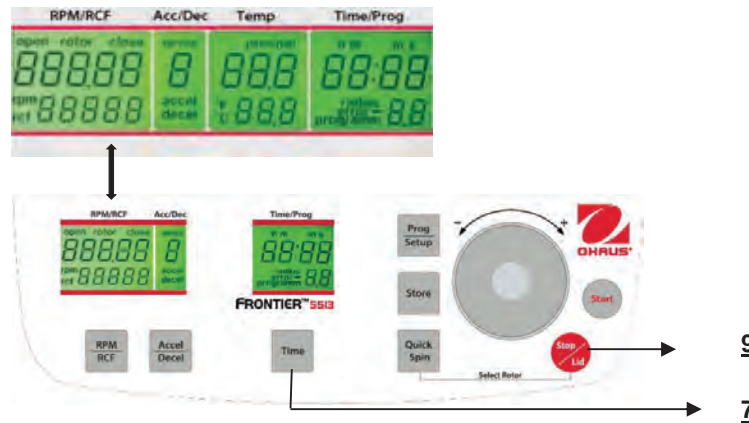

Figure. 28



ATTENTION:

Please notice that you must enter the program as described under point 4.1.2 to change the adjustments of the points 4.1.3 - 4.1.8. After you have stored the settings you can change to normal program mode again by switching off the centrifuge for a short while.

All changed settings must be confirmed by the key "**Start**"(10). The word "**Store**" appears in the display "**RPM/RCF**"(A-1) - Only then the pre-selections are valid!

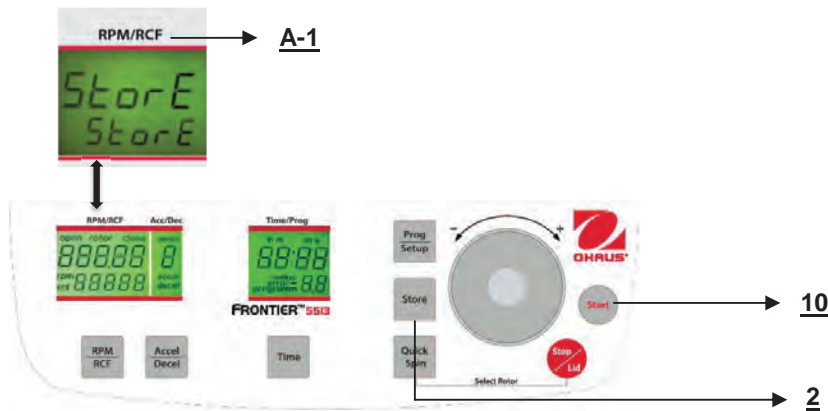

Figure. 29

4.1.3 Signal turn on / off

Proceed as described under point 4.1.2 to enter this program mode and then press the key "**Accel/Decel**" (6). In the display "**Acc/Dec**" (A-2) the word "**Service**" flashes. Now select the letter "**L**" with the adjusting dial (4). As a result, the words "**On Sound**" appears in the display "**RPM/RCF**" (A-1). If you press the key "**RPM/RCF**" (A-1) now, the word "**On**" flashes and you can switch off the sound with the adjusting dial (4) (See figure 30).

After you have stored the settings (See 4.1.2) you change back to the normal program mode again by switching off the centrifuge for a short while.

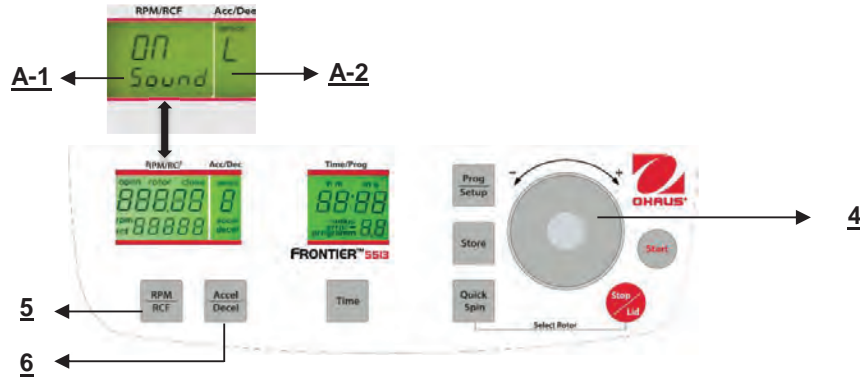

Figure. 30

4.1.4 Volume pre-selection of sound signal

Proceed as described under point 4.1.2 to enter this program mode and then press the key "**Accel/Decel**" (6). In the display "**Acc/Dec**" (A-2) the word "**Service**" flashes. Now select the letter "**U**" with the adjusting dial (4). As a result, in the display "**RPM/RCF**" (A-1) the words "**Vol=0- 9/Sound**" appear. After pressing the key "**RPM/RCF**" (5), you can adjust the desired volume between 0 (low) and 9 (loud) with the adjusting dial (4) (See figure 31).

After you have stored the settings (see 4.1.2) you can change back to the normal program mode again by switching off the centrifuge for a short period.

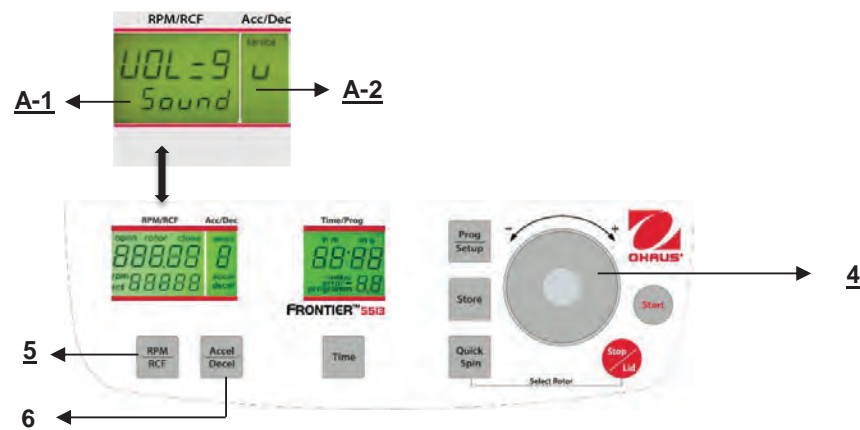

Figure. 31

4.1.5 Song selection for sound signal - end of run

Proceed as described under point 4.1.2 to enter this program mode and then press the key "**Accel/Decel**" (6). In the display "**Acc/Dec**" (A-2) the word "**Service**" flashes. Now select the letter "**G**" with the adjusting dial (4). As a result, in the display "**RPM/RCF**" (A-1), the word "**SonGo/Sound**" appears. After pressing the key "**RPM/RCF**" (5), you can select a song with the adjusting dial (4). (See figure 32).

After you have stored the settings (See 4.1.2) you can change back to the normal program mode again by switch off the centrifuge for a short while.

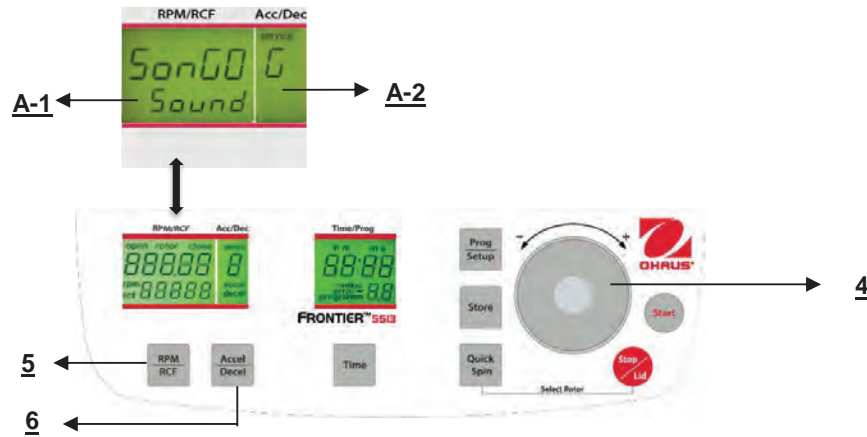

Figure. 32

4.1.6 Keyboard sound turn on / off

Proceed as described under point 4.1.2 to enter this program mode and then press the key "**Accel/Decel**" (6). In the display "**Acc/Dec**" (A-2) the word "**Service**" flashes. Now select the letter "**B**" with the adjusting dial (4). As a result, in the display "**RPM/RCF**" (A-1), the word "**ON/BEEP**" appears. After pressing the key "**RPM/RCF**" (5), you can turn the keyboard sound (On) or (Off) with the adjusting dial (4). (See figure 33).

After you have stored the settings (See 4.1.2) you can change back to the normal program mode again by switch off the centrifuge for a short while.

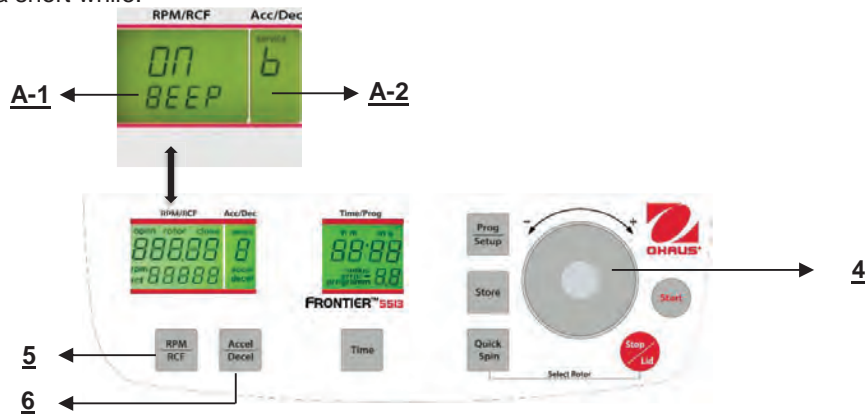

Figure. 33

4.1.7 Sleep Mode On / Off

After not using the centrifuge for 5 minutes, the display automatically switches off. By pressing any bottom, it switches on again. Proceed as illustrated, under point 1.8.2, to enter this program mode, press the key, "accel/decel" (5). In the display, "accel/decel" (A-2) flashes the word, "service". Select the letter "I" with the control field (1). As a result, appearing in the display, "rpm/rcf" (A-1), the word "SLEEP". After pressing the key, "rpm/rcf" (4), turn the sleep mode function (On) or (Off), with the rotary field (1).

After the settings have been stored by user, the normal program mode can be changed back again by switching off the centrifuge, for a short period.

4.1.8 Call up operating data



ATTENTION:

This should only be performed by advance user or service engineer.

In the mode "**Basic Adjustments**" you can call up the operating data of the centrifuge. Please proceed as described under point 4.1.2 to enter this program mode. Press the key "**Accel/Decel**" (6). In the display "**Acc/Dec**" (A-2) the word "**Service**" flashes.

With the adjusting dial (4) the different information can be accessed:

A= previous starts of the centrifuge

H= previous operating hours

S= software version

r= converter software

E= list of previous error messages

h= running time of the motor

The list of the last 99 error messages can be looked over by pressing the key "**RPM/RCF**" (5) and scroll through it by the adjusting dial (4). The respective error codes appear in the display "**RPM/RCF**" (A-1). Please refer to "**Table 6: error messages**" (See APPENDIX).

To change back to normal program mode again, switch off the centrifuge for a short period.

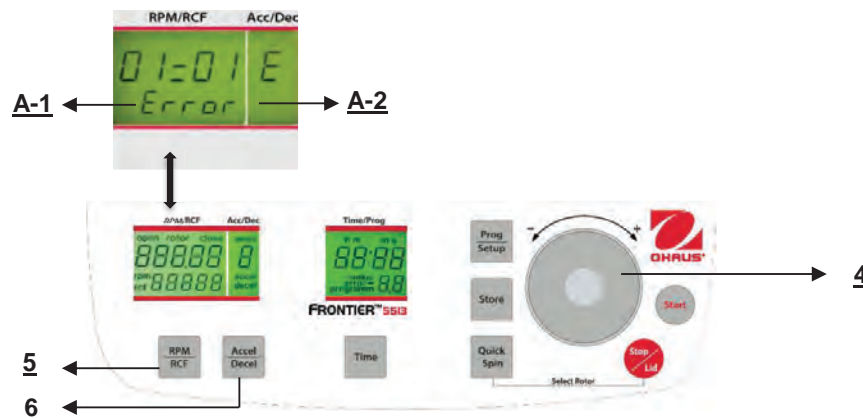

Figure. 34

5. MAINTENANCE

5.1 Maintenance and cleaning

5.1.1 General Care

Maintenance of the centrifuge is confined to keeping the rotor, the rotor chamber and the rotor accessories clean as well as to regularly lubricating the rotor insert bolts of a swing out rotor (if available). Lubricants containing molybdate and graphite are not allowed.

Please pay special attention to anodized aluminum parts. Breakage of rotors can be caused even by slight damage.

In case of rotors, buckets or tube racks getting in touch with corrosive substances the concerned spots have to be cleaned carefully.

Corrosive substances are for instance: alkalis, alkaline soap solutions, alkaline amines, concentrated acids, solutions containing heavy metals, water-free chlorinated solvents, saline solutions, e.g. salt water, phenol, halogenated hydrocarbons.



Cleaning – units, rotors, accessories

- Turn the device off and disconnect it from the power supply before you begin any cleaning or disinfecting. Do not pour liquids into the housing interior.
- Do not spray disinfectant on the device.
- Thorough cleaning not only has its purpose in hygiene but also in avoiding corrosion due to pollution.
- In order to avoid damaging anodized parts such as rotors, reduction plates etc., only pH-neutral Detergents with a pH-value of 6-8 may be used for cleaning. Alkaline cleaning agents (pH-value > 8) must not be used.

- After cleaning, please ensure all parts are dried thoroughly, either by hand or in a hot-air cabinet (max. Temperature + 50°C).
- It is necessary to coat anodized aluminum parts with anti-corrosion oil regularly in order to increase their life-spans and reduce corrosion predisposition.
- Due to humidity or not hermetically sealed samples, condensate may be formed. The condensate has to be removed from the rotor chamber with a soft cloth regularly.



The maintenance procedure has to be repeated every 10 to 15 runs, or at least once a week.

- Connect the unit to the power supply, after the equipment is completely dry.
- Do not carry out disinfection with UV-, beta- and gamma-rays or other high energy radiation.
- Metal rotors can be autoclaved.
- Rotor lid and adapters can also be autoclaved (max. 121°C, 20 min).
- The tube racks are made of PP and cannot be autoclaved at 134°C.

5.1.2 Cleaning and disinfection of the unit

1. Open the lid before you turn off the unit. Disconnect it from the power supply.
2. Open the rotor nut by turning the rotor key counter clockwise.
3. Remove the rotor.
4. For cleaning and disinfection of the unit and the rotor chamber use the above mentioned cleaner.
5. Clean all accessible areas of the device and its accessories, including the power cord with a damp cloth.
6. Wash the rubber seals and rotor chamber thoroughly with water.
7. Rub the dry rubber seals with glycerol or talc to prevent these to becoming brittle. Other components of the unit, e.g. the lid lock, motor shaft and rotor must not be greased.
8. Dry the motor shaft with a soft, dry and lint-free cloth.
9. Control the unit and accessories for damage.

Make sure that the centrifuge is turned off the unit and disconnect the unit from the power supply. Then remove adherent dust from the ventilation slots in the centrifuge by using a soft brush. Do this at least every six months.

5.1.3 Cleaning and disinfection of the rotor

1. Clean and disinfect the rotors, rotor lids and adapters with the above mentioned cleaner.
2. Use a bottle brush to clean and disinfect the rotor bores.
3. Rinse the rotors, rotor lid and adapter with clear water. Particularly the drillings of angle rotors.
4. For drying of the rotors and accessories set them on a towel. Place the angle rotors with bores down.
5. Dry the rotor cone with a soft, dry and lint-free cloth and look for damage. Do not grease the rotor cone.
6. Put the dry rotor back on the motor shaft.
7. Fix the rotor by turning the rotor nut clockwise.

5.1.4 Disinfection of aluminum rotors

In case of infectious material spilling into the centrifuge, the rotor and rotor chamber have to be disinfected directly after the run. Rotors may be autoclaved at a maximum temperature of 121°C.

5.1.5 Disinfection of PP-rotors

Autoclaving

During autoclaving, it's quite possible that plastic parts, i.g. rotor, can become deformed!
The recommended time for autoclaving: 15 – 20 min at 121°C (1 bar)



ATTENTION:

The sterilization time of 20 min. must not be exceeded. Repeated sterilization will cause reduction of the mechanical resistance of the plastic material.

Before autoclaving the PP-rotor and adapter must be thoroughly cleaned to avoid the burning in of dirty residues. You can disregard the consequences of some chemical residues to plastic materials at ambient temperatures. But at the high temperatures during autoclaving those residues may corrode and destroy the plastic. The objects must be thoroughly rinsed with distilled water after the cleaning but before the autoclaving. Residues of any cleaning liquids may cause fissures, whitening and stains.

Gas sterilization

Adapters, bottles and rotors may be gas sterilized with Ethylenoxyd. Make sure to air out the items after the sterilization and before using them again.

**ATTENTION:**

Because the temperature may rise during the sterilization, rotors, adapters and bottles must not be closed and must be totally unscrewed.

Chemical sterilization

Bottles, adapters and rotors may be treated with the usual liquid disinfectants.

**ATTENTION:**

Before applying any other cleaning or decontamination method than recommended by the manufacturer, contact the manufacturer to ensure that it will not damage the unit or the rotor.

5.1.6 Glass breakage

With high g-values, the rate of glass tube breakage increases. Glass splinters have to be removed immediately from rotor, buckets, adapters and the rotor chamber itself. Fine glass splinters will scratch and therefore damage the protective surface coating of a rotor. If glass splinters remain in the rotor chamber, fine metal dust will build up due to air circulation. This very fine, black metal dust will significantly pollute the rotor chamber, the rotor, the buckets and the samples.

If necessary, replace the adapters, tubes and accessories to avoid further damage. Check the rotor bores regularly for residues and damage.

**ATTENTION:**

Please check the relevant specifications of the tubes centrifuges with the manufacturer.

Life time of rotors, buckets, accessories

Rotors and rotor lid made of aluminum or stainless steel, have an operating time of max. 7 years from first use.

Transparent rotor lids and caps made of PC or PP as well as rotors, tube racks and adapters of PP have a maximum operating time up to 3 years from first use.

Condition for the operating time: Proper use damage-free condition, recommended care.

6. TROUBLESHOOTING

6.1 Error message: Cause / Solution

The error messages are listed to help localize possible errors faster.

The diagnosing referred to in this chapter may not always be the case, as they are only theoretically occurring errors and solutions.

Please keep us informed about any kind of error occurring, which is not listed in this chapter. Only through your information are we able to improve this operation manual.

Many thanks in advance for your support.

6.2 Survey of possible error messages and their solutions

6.2.1 Lid release during power failure (Emergency Lid Release)

In case of power failure or malfunction, the lid of the centrifuge can be opened manually in order to protect your samples.

Please proceed as follows:

1. Switch off the centrifuge and unplug the power cord, wait until the rotor has come to a standstill. (this may take several minutes)
2. On the left side of the centrifuge housing there is a plastic stopper (see figure 35). Remove this stopper. Fastened to it, is a string which is connected to the lid lock
3. Pull the string slightly and the lid will open.
4. Open the lid of the centrifuge.
5. Switch the centrifuge on again, to proceed with regular function.

**ATTENTION:**

- Don't put your hands in the rotor chamber as long as the rotor is still spinning!
- Push the plastic stopper back in the unit again, to continue working.



Figure. 35-1

Figure. 35-2

Figure. 35-3

6.2.2 Description of the error message system

The error message "error" (M11) is shown in the "Time/Prog" (A-4) display (See figure 36). Detailed information about possible error messages are in "table 6: error messages" (See APPENDIX).

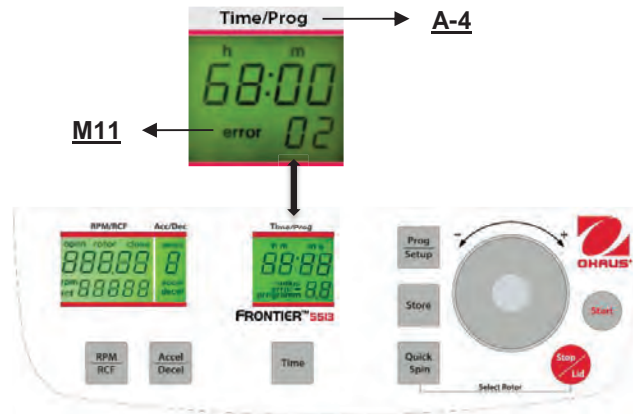

Figure. 36

7. RECEIPT OF CENTRIFUGES TO REPAIR



Health risk from contaminated equipment, rotors and accessories.

In case of returning the centrifuge for repairing to the manufacturer, please notice the following:

The centrifuge must be decontaminated and cleaned before the shipment for the protection of persons, environment and material.

Decontamination certificate at goods return delivery (See APPENDIX)

We reserve the right to not accept contaminated centrifuges.

Further on all costs occurred for the cleaning and disinfection of the units will go to the debit of the customer's account.

8. TRANSPORT AND STORAGE

8.1 Transport

Before transporting, take out the rotor.

Only transport the unit in the original packaging.

Use a transport aid for transporting over longer distances to fix the motor shaft.

	Air temperature	rel. humidity	Air pressure
General transportation	-25 to 60 °C	10 to 75 %	30 to 106 kPa

8.2 Storage

During storage of the centrifuge the following environmental conditions must be observed:

	Air temperature	rel. Humidity	Air pressure
in transport packaging	-25 to 55 °C	10 to 75 %	70 to 106 kPa

9. TECHNICAL DATA

9.1 Specifications

9.1.1 Centrifuge FC5513

Model	FC5513	
Speed Range	200 rpm -13500 rpm;10 rpm/set	
Maximum RCF	17317 x g;10 x g/set	
Maximum Capacity(Rotor)	24x1.5/2.0 ml	
Running Time	10 sec to 99 hr 99 min 59 sec or continuous	
Noise level (depending on the rotor)	≤ 60 dB(A)	
Allowable density at maximum speed	1.2 kg/dm ³	
Allowable kinetic energy	2129 Nm	
Mains power connection AC	230 V/~50-60Hz	120 V/~50-60Hz
Voltage fluctuation	± 10 %	± 10 %
Current consumption	1.05 A	1.9 A
Power consumption	170 W	170 W
Dimensions (W x D x H)	277 x 356 x 236 mm 10.9 x 14.0 x 9.3 in	
Net Weight (without rotor)	12.6 kg 27.8 lb	
Shipping Dimensions (W x D x H)	370 x 470 x 340 mm 14.6 x 18.5 x 13.4 in	
Shipping Weight (without rotor)	14.0 kg 30.9 lb	
Ambient conditions (EN/IEC 61010-1)		
Environment	for indoor use only	
Altitude	Use up to an altitude of 2000 m above MSL	
Ambient temperature	2°C up to 35°C	
Max. relative humidity	Max. relative humidity 80 % for temperatures up to 31°C, decreasing linearly to 50 % relative humidity up to 35°C.	
Overvoltage category (IEC 60364-4-443)	II	
Degree of contamination	2	
Class of protection	I	
Not suitable for use in hazardous environments.		
EMV Interference Emission, Noise Immunity	EN/IEC 61326-1 Class B emissions, Basic immunity FCC Class B emissions	

9.2 Drawings and dimensions

Dimensions for FC5513

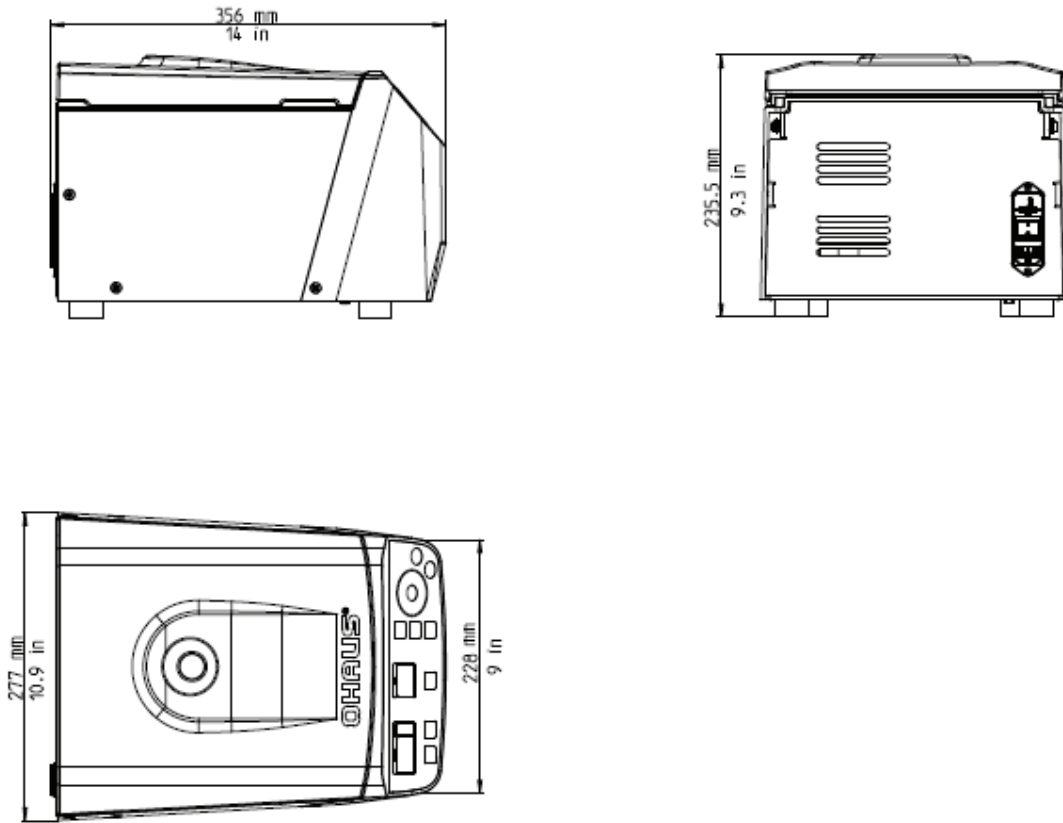

10. ORDER INFORMATION

Rotors

Rotor/Adapter	Description	Units
30472301	Rotor, Angle, 24x1.5/2.0ml, V2	1
30130885	Adapter, 1x0.5ml D8mm, 6/pk	6
30130884	Adapter, 1x0.2/0.4ml D6mm, 6/pk	6
30472302	Rotor, Angle, 24x1.5/2.0ml, Sealable, V2	1
30130885	Adapter, 1x0.5ml D8mm, 6/pk	6
30130884	Adapter, 1x0.2/0.4ml D6mm, 6/pk	6
30472303	Rotor, Angle, 18x2ml SC	1
30472304	Rotor, Hematocrit, 24xCapillaries, V2	1

Notes: Packages are country specific and might vary. Please check the item number with the local OHAUS office before you order it.

11. COMPLIANCE

Compliance to the following standards is indicated by the corresponding mark on the product.

Marking	Standard
	This product conforms to the RoHS Directive 2011/65/EU, the EMC Directive 2014/30/EU and the Low Voltage Directive 2014/35/EU. The complete Declaration of Conformity is available online at .

	<p>Disposal</p> <p>In conformance with the European Directive 2012/19/EU on Waste Electrical and Electronic Equipment (WEEE) this device may not be disposed of in domestic waste. This also applies to countries outside the EU, per their specific requirements.</p> <p>Please dispose of this product in accordance with local regulations at the collecting point specified for electrical and electronic equipment.</p> <p>If you have any questions, please contact the responsible authority or the distributor from which you purchased this device.</p> <p>Should this device be passed on to other parties (for private or professional use), the content of this regulation must also be related.</p> <p>For disposal instructions in Europe, refer to</p> <p>Thank you for your contribution to environmental protection.</p>
---	--

FCC Note

This equipment has been tested and found to comply with the limits for a Class B digital device, pursuant to Part 15 of the FCC Rules. These limits are designed to provide reasonable protection against harmful interference in a residential installation. This equipment generates, uses and can radiate radio frequency energy and, if not installed and used in accordance with the instructions, may cause harmful interference to radio communications. However, there is no guarantee that interference will not occur in a particular installation. If this equipment does cause harmful interference to radio or television reception, which can be determined by turning the equipment off and on, the user is encouraged to try to correct the interference by one or more of the following measures:

- Reorient or relocate the receiving antenna.
- Increase the separation between the equipment and receiver.
- Connect the equipment into an outlet on a circuit different from that to which the receiver is connected.
- Consult the dealer or an experienced radio/TV technician for help.

12. APPENDIX

TABLE 1: PERMISSIBLE NET WEIGHT

TABLE 2: MAX. SPEED AND RCF-VALUES FOR PERMISSIBLE ROTORS

TABLE 3: ACCELERATION AND DECELERATION TIMES

TABLE 4: ERROR MESSAGES

TABLE 5: (PART 1): RADIUS CORRECTION

TABLE 6: SYMBOLS- / ABBREVIATIONS

TABLE 7: REDEMPTION FORM / DECONTAMINATION CERTIFICATE

12.1 Table 1: Permissible net weight

Rotor	Description	Max. speed	Permissible net weight
30472301	Rotor, Angle, 24x1.5/2.0ml, V2	13500 min ⁻¹	82 g
30472302	Rotor, Angle, 24x1.5/2.0ml, Sealable, V2	13500 min ⁻¹	82 g
30472303	Rotor, Angle, 18x2ml SC	13500 min ⁻¹	68 g
30472304	Rotor, Hematocrit, 24xCapillaries, V2	13000 min ⁻¹	4.8 g

12.2 Table 2: Max. speed and RCF-values for permissible rotors

Rotor	Description	Max. speed	RCF value
30472301	Rotor, Angle, 24x1.5/2.0ml, V2	13500 min ⁻¹	17317 xg
30472302	Rotor, Angle, 24x1.5/2.0ml, Sealable, V2	13500 min ⁻¹	17317 xg
30472303	Rotor, Angle, 18x2ml SC	13500 min ⁻¹	15484 xg
30472304	Rotor, Hematocrit, 24xCapillaries, V2	13000 min ⁻¹	16058 xg

12.3 Table 3: Acceleration and deceleration times

Rotor	Acceleration		Deceleration	
	Stage 0	Stage 9	Stage 0	Stage 9
30472301	110	15	118	14
30472302	110	15	118	14
30472303	109	13	121	14
30472304	156	20	160	22
in seconds				
		Acceleration time		Deceleration time
		from 0 min ⁻¹ -> V _{max}		from V _{max} -> 0 min ⁻¹

12.4 Table 4: Error messages

Error-No.:	Description
1	Imbalance arose
2	Imbalance sensor is defective
4	Imbalance switch has been activated for longer than 5 seconds
8	Transponder in the rotor is defective
14	Leap of speed is too big between two measurements
CLOSE lid	
15	Standstill monitoring defective
16	Wrong direction of rotation of the motor
33	Open lid while motor is running
34	Lid contact defective
38	Lid motor is blocked
40	Communication with frequency converter disturbed during start
41	Communication with frequency converter disturbed during stop
42	Short circuit in the frequency converter
43	Undervoltage frequency converter
44	Overvoltage frequency converter
46	Over temperature motor
47	Over current frequency converter
48	Timeout between control unit and frequency converter
49	Other error frequency converter
55	Overspeed
70	Timeout between controller and RS232 interface
80	Memory Error internal EEPROM
99	Rotor is not allowed in this centrifuge
FALSE	Inserted rotor does not exist in the program
rotor no	Rotor is not detected

12.5 Table 5 (part 1): Radius correction

Rotor	Description	Adapter	Radius (cm)	Correction (cm)
30472301	Rotor, Angle, 24x1.5/2.0ml, V2	None	8.5	0
		30130890	8.2	-0.3
		30130886	7.4	-1.1
30472302	Rotor, Angle, 24x1.5/2.0ml, Sealable, V2	None	8.5	0
		30130890	8.2	-0.3
		30130886	7.4	-1.1

12.6 Table 6: Symbols- / Abbreviations

Symbol /	Unit	Description
n (=rpm)	[min ⁻¹]	revolutions per minute
RZB(=rcf)	[x g]	relative centrifugal force
PP	-	Polypropylen
PC	-	Polycarbonat
accel	-	acceleration
decel	-	deceleration
prog	-	program

12.7 Table 7: Redemption form / Decontamination certificate

Enclose this form with all returns of equipment and assemblies!

The completed declaration about the decontamination is a prerequisite for the assumption and further processing of the return. If no corresponding explanation is enclosed, we carry out decontamination with costs at your expense.

Surname; last name: _____

Organization / company: _____

Street: _____

ZIP CODE: _____ Place: _____

Telephone: _____ Fax: _____

E-Mail: _____

Please fill out in block capitals!

Pos.	Crowd	Decontaminated object	Serial number	Description / Comment
1				
2				
3				
4				

Are the parts listed above in contact with the following substances?

- Health endangering watery solutions, buffers, acids, alkalis: _____ Yes No
- ... Potentially infectious agents: _____ Yes No
- ... Organic reagents and solvent: _____ Yes No
- ... Radioactive substances: _____ α.. β.. γ _____ Yes No
- ... Health endangering proteins: _____ Yes No
- ... DNA: _____ Yes No
- ... These substances have reached the equipment/assembly? _____ Yes No
- ...

Which one, if yes:

Description of the measures for the decontamination of the listed parts:

I confirm the proper decontamination:

Company/Dept. _____ Place and Date: _____

Signature of the authorized person n: _____

For Europe

WARRANTY REGISTRATION
BON D'ENREGISTREMENT DE LA GARANTIE
GARANTIE-REGISTRIRUNG
REGISTRO DE GARANTIA
REGISTRAZIONE DELLA GARANZIA
REJESTRACJA GWARANCJI
REGISTRAZIONE DELLA

Protect your investment –Register your product online at _____

Please contact your local OHAUS dealer for product service and warranty support.

Veuillez contacter votre revendeur OHAUS local pour l'entretien et la réparation des produits et le soutien de la garantie.

Wenden Sie sich bitte an Ihren örtlichen OHAUS-Händler, wenn Sie Produktservice und Garantie-Support benötigen.

Comuníquese con su distribuidor OHAUS más cercano para servicio del producto y asistencia de garantía.

Contattare il rappresentate OHAUS locale per il supporto ai prodotti e l'assistenza in garanzia.

Retain this section for your records

**Partie a conserver au titre de la garantie
Bewahren Sie diesen Abschnitt in Ihren Unterlagen auf
Conserve esta seccion para sus archivos
Conservate Questa Parte**

Odcinek dla uzytkownika

Model No.; Ref. du Modèle; Modell; Modelo; Modello

Serial No; No de Série; Serien-Nr; Num de Serie; Numero di Serie; Numer Seryjny

Purchase Date; Date d'Achat; Bestelldatum; Fecha de Compra; Data d'Acquisto; Data Zakupu

Purchased from; Acheté à; Lieferant; Compania Comprado a

Acquistata da;Zakupione od

For US & Canada

Retain this card for your records

Protect your investment –Register your product online at

To activate the product warranty, you must register your product in the support section on within 30 days from date of purchase. No other express or implied warranty is given by OHAUS Corporation. OHAUS Corporation shall not be liable for any consequential damages.

Model NO.: _____ Serial No. (if applicable): _____

Purchase Date: _____ Purchased From: _____

Notes: _____

For Asia Pacific

Retain this card for your records

Protect your investment –Register your product online at

Please contact your local OHAUS dealer for product service and warranty support. To activate the product warranty you must register your product at . No other express or implied warranty is given by OHAUS Corporation. OHAUS Corporation shall not be liable for any consequential damages.

Model NO.: _____ Serial No. (if applicable): _____

Purchase Date: _____ Purchase From: _____

Notes: _____