

# High-Resolution Digimatic Measuring Unit LITEMATIC VL-50-B/50S-B

Bulletin No.2066



Low and constant measuring force of 0.01N, 0.15N, or 1N

# Mitutoyo

Providing low and constant measuring force for high-accuracy inspection of delicate workpieces

# LITEMATIC VL-50-B/50S-B

## FEATURES

## VL-50-B/50S-B

- Patent registered (Japan), Patent pending (Japan)

### Ideal for measuring the thickness or height of a workpiece that can be easily affected by the measuring force

- With a measuring force of only 0.01N, the Litematic is ideal for measuring easily deformed workpieces or high-accuracy components.
- For workpieces for which 0.01N is insufficient, either the 0.15N or 1N model is recommended.
- The spindle is motor-driven and stops when the contact point touches the workpiece. From then on, the maximum, minimum, or difference value can be measured using a constant measuring force.

### High-accuracy measurement

- High resolution down to 0.01 $\mu$ m and a wide 50mm measurement range. The use of a low thermal-expansion material for the spindle and ceramic for the measuring table minimizes the effect of temperature variation during use. The unit is rust-free, simplifying maintenance and management.



### Separate type VL-50S-B

Because the measuring unit and the display unit are separate, they can be integrated into the user's measurement system. An optional dedicated stand is also available.



\*The stand (No.957460) is sold as an option.

### Constant measuring force principle

**An unbalanced, parallel-link structure enables the Litematic to offer a low and constant measuring force.**

The Litematic's measuring force is not provided by a spring but comes from a structure resembling a balance scale. We call this a "parallel linkage." A motorized slider carrying the linked spindle moves down its guideway while the linkage is supported on a stop, as shown in Fig. 1. When the spindle contacts the workpiece (Fig. 2) it moves the linkage up off the stop and the motor is halted. At this point the linkage is now supported by the workpiece, and thus a constant measuring force is applied.

Fig. 1. The spindle moves downwards towards the workpiece.

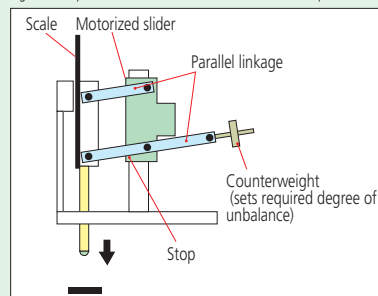
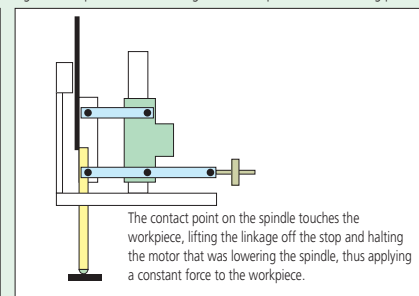

Fig. 2. The spindle lifts the linkage off the stop into the measuring position.



Mitutoyo

Find Quality Products Online at:

[www.GlobalTestSupply.com](http://www.GlobalTestSupply.com)

[sales@GlobalTestSupply.com](mailto:sales@GlobalTestSupply.com)

## Measurement Applications

### Rubber and plastic

If the workpiece is soft the risk of indentation may be reduced by replacing the standard contact point with one of larger radius, such as an optional carbide-ball type.

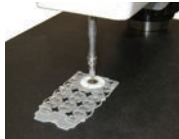

- ▶ Plastic
- ▶ Rubber
- ▶ Keypad



### Glass

For this type of workpiece the smallest measuring force available is recommended.



- ▶ Blue plate glass
- ▶ Lenses
- ▶ Contact lenses



### Film and sheet

If the workpiece flexes, making accurate measurement impossible, using a type with a larger measuring force or adding a weight to the spindle may be effective.

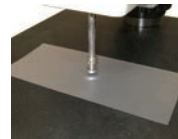

- ▶ Film
- ▶ Flexible substrates
- ▶ Various types of sheet



### Precision components

The Litematic can be used as a high-precision displacement gage.

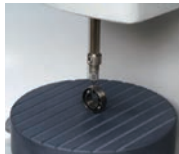

- ▶ Bearing
- ▶ Shaft

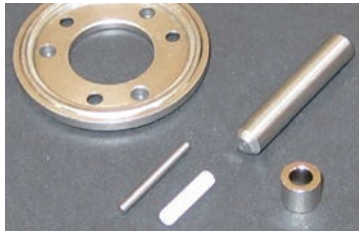

### Thin sheet metal

Because the measuring force is small, deformation of the workpiece can be minimized.

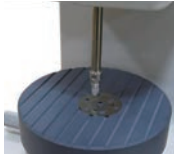

- ▶ Chassis
- ▶ Shimming materials
- ▶ Blade springs
- ▶ Beverage can materials

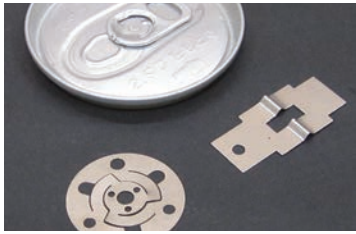

### Media discs

For this type of workpiece the smallest measuring force available is recommended.

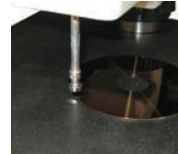

- ▶ Media tape
- ▶ Hard disks
- ▶ Various types of disks



### Medical and pharmaceutical products

If the workpiece is soft the risk of indentation may be reduced by replacing the standard contact point with one of larger radius, such as an optional carbide-ball type.

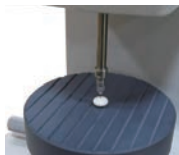

- ▶ Injection needles
- ▶ Pills
- ▶ Patches and ointments



### Semiconductors

If the workpiece flexes, making accurate measurement impossible, using a type with a larger measuring force or adding a weight to the spindle may be effective.

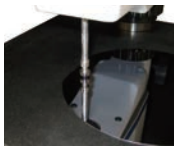

- ▶ Chips
- ▶ Wafers
- ▶ Lead frames

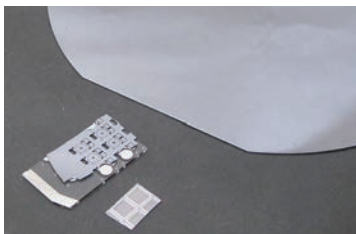

### Electronic components

For this type of workpiece the smallest measuring force available is recommended.



- ▶ Printed circuit boards
- ▶ Connectors
- ▶ Battery components

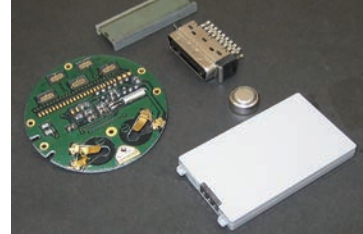

# LITEMATIC VL-50-B/50S-B

## FUNCTIONS

## VL-50-B/50S-B

### • Control panel/Display Unit

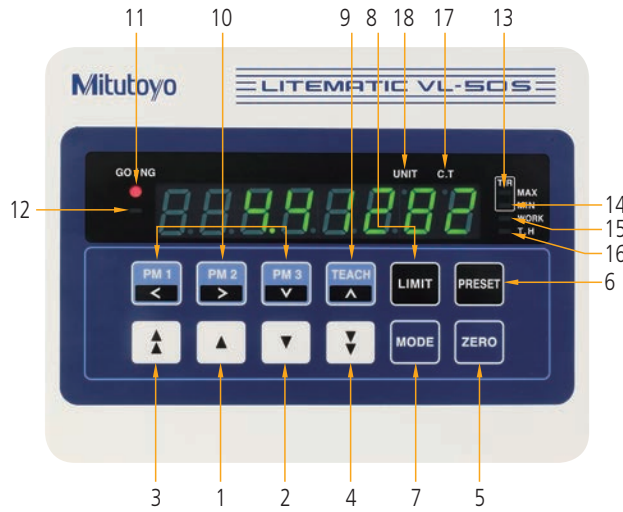

Key	Function
1) Up	Moves the spindle up only while the key is pressed.
2) Down	Moves the spindle down only while the key is pressed. Used to touch the contact point on a workpiece to make a measurement.
3) Rapid Up	Moves the spindle up quickly only while the key is pressed.
4) Rapid Down	Moves the spindle down quickly only while the key is pressed.
5) ZERO	Sets the origin at any position of the spindle. Also, it zero-sets all display values for difference measurements. This key can be used to clear an error.
6) PRESET	Allows the currently displayed value to be set from the keyboard, irrespective of spindle position. Often used in conjunction with gauge blocks.
7) MODE	Selects and sets one of various measurement modes such as MAXMIN measurement.
8) LIMIT	Enters tolerance limits for tolerance judgment.
9) TEACH	Sets up the position memory.
10) PM1 to Pm3	Moves the spindle to a previously stored position with a single keystroke.

Indicator (LED)	Function	
11) GO/NG	Displays the result of a GO/NG judgment.	
12) Sign	Lights to display a minus value.	
13) MAX	Lights in the maximum value mode.	Both light when the measurement is the difference type (MAX - MIN).
14) MIN	Lights in the minimum value mode.	
15) WORK	Lights while a workpiece is being measured.	
16) T.H.	Lights when a measurement value is held after measurement has been completed.	
17) C.T.	Lights when the user compensation is set to ON. (Lights while the position memory is active.)	
18) UNIT	Lights while the unit of display values is inch. (Lights in the external HOLD mode.)	

### • Rear panel (switches and connectors)

VL-50-B

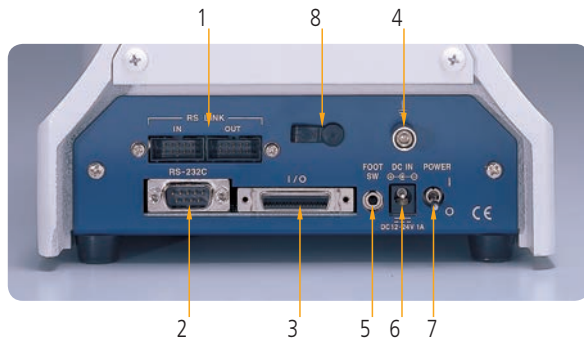

VL-50S-B

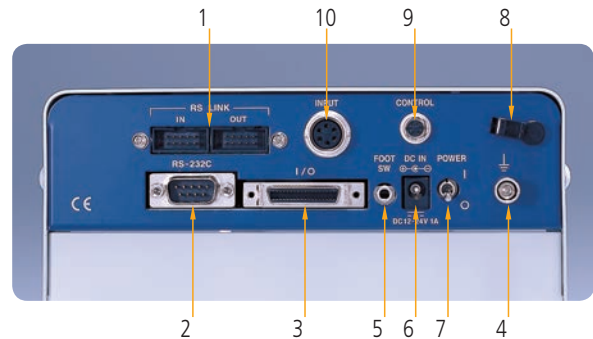

1) Measurement data output connector (OUT)	Outputs measurement data to a Digimatic mini-processor, etc.
RS-LINK connector (IN/OUT)	Connects multiple devices and can output measurement data from one RS-232 port.
2) RS-232C connector	For communication with a PC, etc.
3) External control connector	Used to connect this instrument to an external device for remote control.
4) GND terminal	—
5) Foot switch	Foot switch (optional) for controlling measurement operation is connected here.
6) DC IN	Input connector to receive power from the AC mains adapter.
7) Power switch	—
8) AC adapter cord clamp	Prevents AC adapter cord from pulling out.
9) CONTROL connector: for VL-50S-B only	Gage head connector.
10) INPUT connector: for VL-50S-B only	Gage head connector.

## SPECIFICATIONS

# VL-50-B/50S-B

Order No.	318-221A	318-222A	318-223A	318-226A	318-227A	318-228A
Model	VL-50-B	VL-50-15-B	VL-50-100-B	VL-50S-B	VL-50S-15-B	VL-50S-100-B
Measuring Range <sup>*1</sup>	0-50mm (0 - 2")					
Resolution (selectable)	0.01/0.1/1.0μm (.000005"/.000005"/.00005")					
Display unit	Character height 14mm (.6")/8 digits (excluding "minus" sign)					
Scale type	4/4 Photoelectric reflection linear encoder					
Stroke	51.5mm (2") With standard contact point					
Accuracy at 20°C <sup>*1</sup>	(0.5+L/100)μm L = Measured length (mm)					
Accuracy guarantee temperature <sup>*2</sup>	20 ± 1°C					
Repeatability <sup>*1</sup>	σ = 0.05 μm					
Measuring force <sup>*1</sup>	0.01N (approx. 1gf)	0.15N (approx. 15.3gf)	1N (approx. 102gf)	0.01N (approx. 1gf)	0.15N (approx. 15.3gf)	1N (approx. 102gf)
Spindle feed speed	Measuring	Approx. 2mm/s (.08"/s) or 4mm/s (.16"/s) (selectable by parameter)				
	Quick feed	Approx. 8mm/s (.3"/s)				
Standard contact point	ø3mm carbide ball					
Worktable	ø100 (Ceramic, grooved, replaceable)					
Input	Data can be input with the foot switch					
Output	SPC output RS-232C output (switching by parameter)					
Power supply	85V to 264VAC (connected to AC adapter)					
Power consumption	Maximum 12W (12V, 1A)					
Main unit mass	19kg (35.2lbs)			6kg (11lbs)		
Standard accessories	• AC adapter: No.357651 • Power cord • Grounding wire: No.934626 • Allen wrench (for replacing the interchangeable contact point)					
Optional accessories	Foot switch: 937179T					
				Dedicated stand: 957460		
	Output connector (with cover): 02ADB440 (for external control)					
	RS-LINK/Digimatic connecting cable (1m): 936937 RS-LINK/Digimatic connecting cable (2m): 965014					
	Recommended interchangeable contact points: the following dial indicator interchangeable contact points are mountable.					
	Part No.: 101118			Measuring force*: Approx 0.02N		
	Part No.: 120059			Measuring force*: Approx 0.03N		
	Part No.: 120060			Measuring force*: Approx 0.06N		
	Part No.: 120066			Measuring force*: Approx 0.01N		
	Note: When another contact point that has a flat measuring face is mounted, the contact point requires parallelism adjustment with respect to the table surface. Mounting this contact point should be custom-ordered from Mitutoyo.					
02AZE375			Measuring force*: Approx 0.01N to 0.96N			
Note: The above VL weight parts are dedicated weight parts for VL-50-B and VL-50S-B. Be careful when setting a measuring force of 1N or greater as this may cause equipment failure.						

\* Additional measuring force that is applied when non-standard contact points or VL weights are used.

\*1 Using the standard contact point.

\*2 Temperature variation must be gradual. The instrument must not be exposed directly to hot or cold drafts.

# LITEMATIC VL-50-B/50S-B

## DIMENSIONS

(Unit: mm)

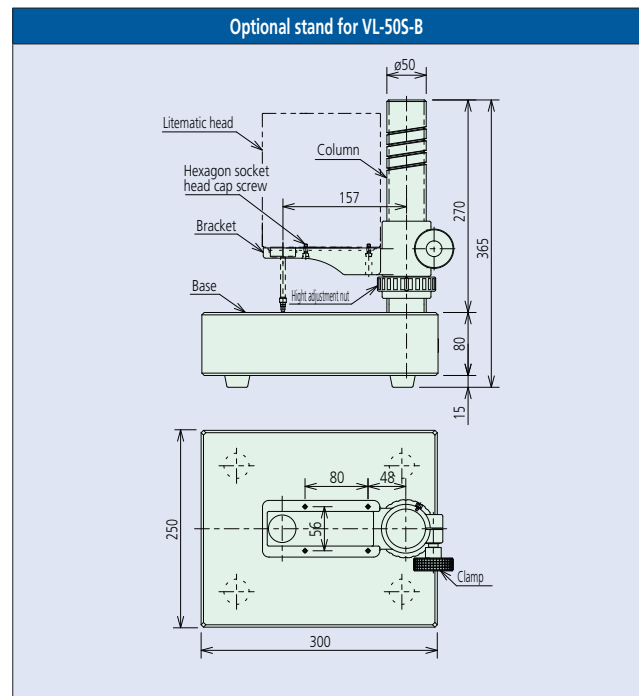
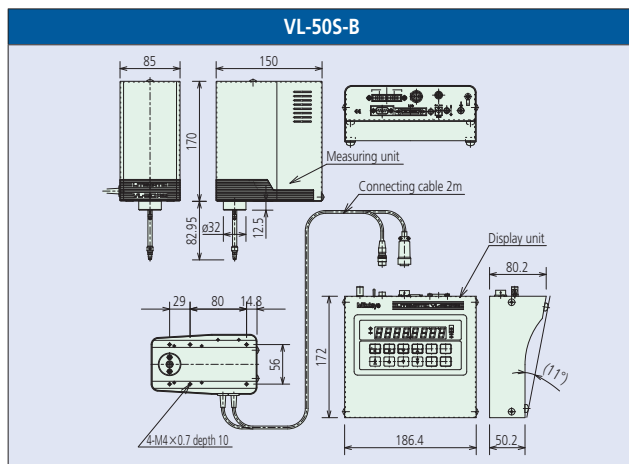
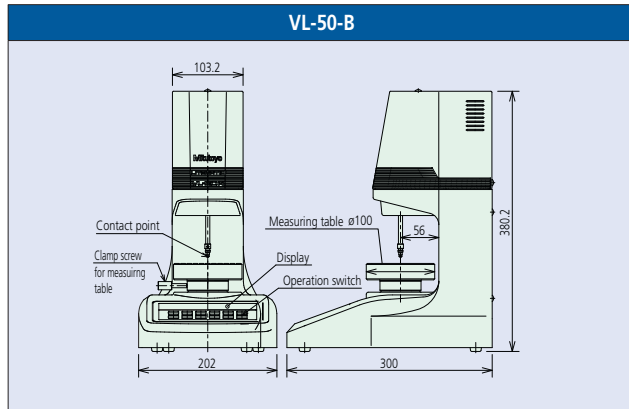

## Interchangeable contact points

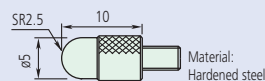

Order No.	Measuring force
101118	0.02N

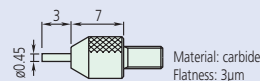

Order No.	Measuring force
120066	0.01N

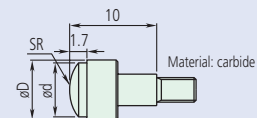

Order No.	Measuring force	D	d	SR
120059	0.03N	ø7.5	ø6.5	7
120060	0.06N	ø10.5	ø9.5	10

Note: When a contact point having a flat measuring surface, other than those described above, is installed, the measuring surface must be adjusted for parallelism with the table surface. This requires a special order.

## • Optional weights for the Litematic (No. 02AZE375)

One of the notable characteristics of the Litematic is its small measuring force (0.01N or 0.15N models). However, depending on the characteristics of the workpiece, it may not be possible to transmit a sufficient measuring force and the contact point may appear suspended. To solve such a problem, optional weights are available that attach to the spindle to achieve the appropriate measuring force without damaging the workpiece.

\*Cannot be used with VL-50AH, VL-50-100-B, or VL-50S-100-B

Spindle with an optional weight installed



External appearance of optional weights

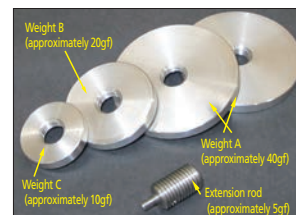

Measuring forces generated by weight combinations for 0.01/0.15N models

Measuring force (N)		Extension rod	A	B	C
VL-50-B/50S-B	VL-50-15-B/50S-15-B				
0.01	0.15				
0.06	0.21	1			
0.16	0.31	1			1
0.26	0.41	1		1	
0.36	0.51	1	1	1	1
0.46	0.61	1	1		
0.56	0.71	1	1	1	1
0.66	0.81	1	1	1	1
0.76	0.91	1	1	1	1
0.86	—	1	2		
0.96	—	1	2	1	

## • Connector terminal Function

### 1) Applicable plugNo.02ADB440

No.02ADB440 (with cover) Optional accessory

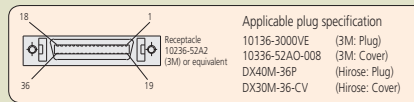

### 2) Pin assignment

Pin No.	Signal name	Input/Output	Description (purpose)																			
1	COM	—	Common terminal to input and output circuits (internally connected to GND)																			
2	COM	—																				
3	L1	OUT	Tolerance judgment output terminal A related judgment terminal only outputs "L" At error occurrence L1, L5 = Outputs "L" L2, L3, L4 = Outputs "H"																			
4	L2	OUT																				
5	L3	OUT																				
6	L4	OUT																				
7	L5	OUT																				
10	NOM	OUT	Outputs "L" in the count mode.																			
21	ULIMIT	OUT	Outputs "L" at the top dead point of the spindle.																			
22	WORK	OUT	Outputs "L" upon detection of a workpiece.																			
25	SET1	IN	Specifies peak selection/motor speed in combination with SET.																			
26	SET2	IN																				
28	MODE	IN	Peak selection: In combination with SET																			
			<table border="1"> <thead> <tr> <th>Peak mode</th> <th>SET2</th> <th>SET1</th> </tr> </thead> <tbody> <tr> <td>Current value</td> <td>H</td> <td>H</td> </tr> <tr> <td>MAX</td> <td>H</td> <td>L</td> </tr> <tr> <td>MIN</td> <td>L</td> <td>H</td> </tr> <tr> <td>TIR</td> <td>L</td> <td>L</td> </tr> </tbody> </table>	Peak mode	SET2	SET1	Current value	H	H	MAX	H	L	MIN	L	H	TIR	L	L				
			Peak mode	SET2	SET1																	
			Current value	H	H																	
			MAX	H	L																	
MIN	L	H																				
TIR	L	L																				
Motor control: Specifies a spindle ascent speed along with SET.																						
<table border="1"> <thead> <tr> <th>Speed</th> <th>SET2</th> <th>SET1</th> </tr> </thead> <tbody> <tr> <td>VL-50B/50-SB</td> <td></td> <td></td> </tr> <tr> <td>8mm/s</td> <td>H</td> <td>H</td> </tr> <tr> <td>4mm/s</td> <td>H</td> <td>L</td> </tr> <tr> <td>2mm/s</td> <td>L</td> <td>H</td> </tr> <tr> <td>1mm/s</td> <td>L</td> <td>L</td> </tr> </tbody> </table>	Speed	SET2	SET1	VL-50B/50-SB			8mm/s	H	H	4mm/s	H	L	2mm/s	L	H	1mm/s	L	L	When changing the spindle speed, stops the spindle once and allows 50ms or more before change.			
Speed	SET2	SET1																				
VL-50B/50-SB																						
8mm/s	H	H																				
4mm/s	H	L																				
2mm/s	L	H																				
1mm/s	L	L																				
Motor control: Specifies a spindle ascent speed along with SET.																						
31	DN	IN	Motor control: Specifies a spindle ascent speed along with SET.																			
			<table border="1"> <thead> <tr> <th>Speed</th> <th>SET2</th> <th>SET1</th> </tr> </thead> <tbody> <tr> <td>VL-50B/50-SB</td> <td></td> <td></td> </tr> <tr> <td>8mm/s</td> <td>H</td> <td>H</td> </tr> <tr> <td>4mm/s</td> <td>H</td> <td>L</td> </tr> <tr> <td>2mm/s</td> <td>L</td> <td>H</td> </tr> <tr> <td>1mm/s</td> <td>L</td> <td>L</td> </tr> </tbody> </table>	Speed	SET2	SET1	VL-50B/50-SB			8mm/s	H	H	4mm/s	H	L	2mm/s	L	H	1mm/s	L	L	When changing the spindle speed, stops the spindle once and allows 50ms or more before change.
			Speed	SET2	SET1																	
			VL-50B/50-SB																			
			8mm/s	H	H																	
4mm/s	H	L																				
2mm/s	L	H																				
1mm/s	L	L																				
Motor control: Same function as that of foot switch.																						
32	FSW	IN	Motor control: Same function as that of foot switch.																			
34	HOLD	IN	The display value is held during input. At error occurrence the error is cleared at the leading edge of this signal.																			
35	P.SET	IN	Executes presetting. Peak clear: The peak value is cleared upon input of the signal during the HOLD signal input in the Peak mode.																			
			Unconnected terminals (8, 9, 11-20, 23, 24, 27, 29, 33 and 36 pin terminals)																			

### (3) Input/output circuit

1. Output circuit: When the signal goes to "Low," the transistor turns on. (Open collector output)

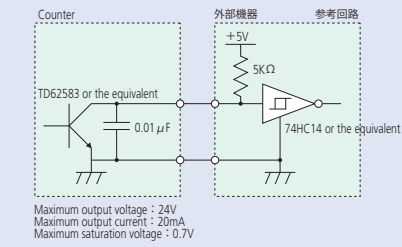

2. Input circuit: When the signal goes to "Low," the input is enabled.

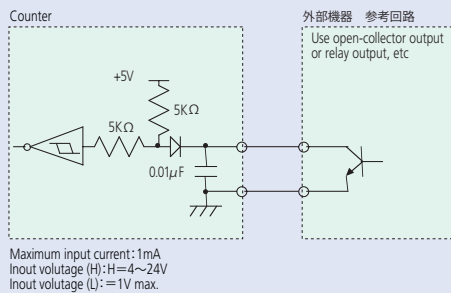

### (4) Timing Chart

#### 1. Power On characteristics

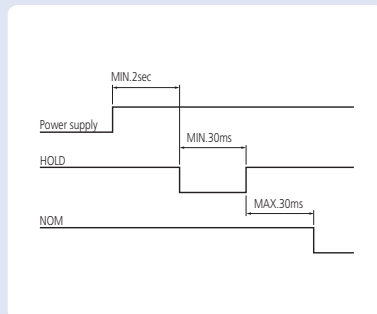

#### 2. External presetting

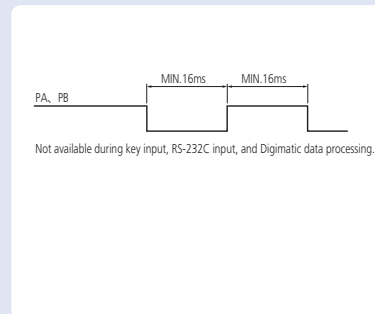

#### 3. Tolerance judgment result output timing

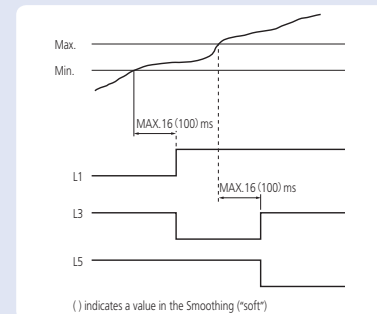

#### 4. Mode/Up/DN timing

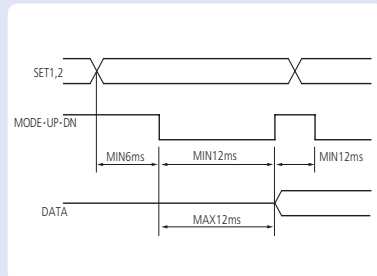

#### 5. HOLD, Error clear

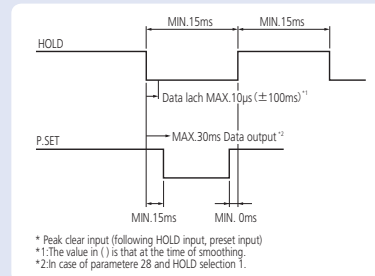

#### 6. RS-232C command input and response output

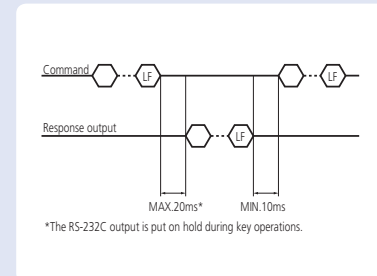

#### RS-232C data output time

The maximum output time when the all-data-output command (GA00CRLF) is used can be calculated using the following formula:

$$\text{Maximum output time [ms]} = \text{counter connection count} \times 20 + \text{connected channel} \times 17 (8.5) + 6 (3)$$

\*At a transfer speed of 9,600 bps; figures inside ( ) indicate values [in ms] when the speed is 19,200 bps.

(Calculation example) 1 VL unit = MAX43 (31.5) ms (Note: The processing time by the personal computer is not included.)

# • RS-232C Communication Function

## (1) List of commands

Command format	Response output	Operation content
GA ** CRLF	G # ** , +01234.567CRLF	A display value is output via RS-232C. "***" indicates gage channel numbers 01 to 99 (all channel number to 01 "0" indicates the type of data (N: current value, X: maximum value, M: minimum value, and W: TIR)CRLF stands for carriage return (CR) and line feed (LF).
CN ** CRLF	CH ** CRLF	The display is switched to the current value.
CX ** CRLF	CH ** CRLF	The display is switched to the maximum value.
CM ** CRLF	CH ** CRLF	The display is switched to the minimum value.
CW ** CRLF	CH ** CRLF	The display is switched to the TIR value.
CR ** CRLF	CH ** CRLF	The display is zero-set.
CL ** CRLF	CH ** CRLF	The peak value is cleared.
CP ** ,+01234567CRLF	CH ** CRLF	The preset value is input. Input a preset value and a tolerance limit with a sign and a numeric value of 8 digits without appending a decimal point.
CD ** ,+01234567CRLF	CH ** CRLF	Input tolerance limit S1. Perform tolerance setup in the order of CD and CG for 3-step tolerance judgment, and in the order of CD, CE, CF, and CG for 5-step tolerance judgment. An error message is output if there is a difference in tolerance limit order, or in the number of steps between the setting and data to be sent, or if incorrect data exists. If this is the case, repeat setup from the beginning of the CD command.
CE ** ,+01234567CRLF	CH ** CRLF	Input tolerance limit S2.
CF ** ,+01234567CRLF	CH ** CRLF	Input tolerance limit S3.
CG ** ,+01234567CRLF	CH ** CRLF	Input tolerance limit S4.
CS ** CRLF	CH ** CRLF	An error is canceled.
VS ** ,+ \$ CRLF	CH ** CRLF	Spindle control Sign +: Moves up the spindle., -: Moves down the spindle. \$: Speed specification 0: Stop 1: 2mm/s 2: 4mm 3: 8mm/s approx.
VT ** ,+ \$ CRLF	CH ** #CRLF	Status of spindle condition In place of #, 0: Normal 1: Upper dead point limit 2: WORK ON Channel number 00 cannot be used.

## (2) Pin assignment

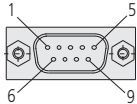

- Receptacle specification: D-sub 9-pin (male), inch thread spec.
- Applicable plug specification: D-sub 9-pin (female), inch thread spec.
- Commercial cable examples:  
For DOS/V: KRS-403XF1K (1.5m), Sanwa Supply Corp.  
For PC-98 series: KRS-423XF1K (1.5m), Sanwa Supply Corp.

Pin No.	Signal name	Input/Output	Definition
2	RXD	IN	Receive data
3	TXD	OUT	Transmit data
4	DTR	OUT	Data terminal ready
5	GND	—	Ground
6	DSR	IN	Data set ready
7	RTS	OUT	Request to send
8	CTS	IN	Clear to send
1, 9	N.C.	—	Unconnected

## Digimatic output function

\* The number of significant digits in the Digimatic output is 6.

### Data transmission to the PC

#### Input Tool IT-012U No. 264-012-10

Converts the Digimatic output from Litematic into keyboard signals and transfers to the PC.

Connecting cable (No.936937)



### Printer

#### Digimatic mini processor DP-1VR No. 264-504-5A

Prints the Digimatic output from Litematic.

Connecting cable (No.936937)



## (3) Communication protocol (EIA RS-232C compatible)

Home position	DTE (terminal) and cross cable are to be used.
Communication method	half-duplex, non-procedural
Baud rate	4800, 9600, 19200bps
Bit configuration	Start bit: 1 Data bits: (7 or 8) ASCII, uppercase Parity bit: None, even or odd Stop bits: 2
Communication condition setup	Set with parameters. See "3.3 List of Parameters".

Coordinate Measuring Machines

Vision Measuring Systems

Form Measurement

Optical Measuring

Sensor Systems

Testing Equipment and  
Seismometer

Digital Scale and DRO Systems

Small Tool Instruments and  
Data Management

Mitutoyo America Corporation

**Note:** All information regarding our products, and in particular the illustrations, drawings, dimensional and performance data contained in this printed matter as well as other technical data are to be regarded as approximate average values. We therefore reserve the right to make changes to the corresponding designs. The stated standards, similar technical regulations, descriptions and illustrations of the products were valid at the time of printing. In addition, the latest applicable version of our General Trading Conditions will apply. Only quotations submitted by ourselves may be regarded as definitive. Specifications are subject to change without notice.

Mitutoyo products are subject to US Export Administration Regulations (EAR). Re-export or relocation of our products may require prior approval by an appropriate governing authority.

### Trademarks and Registrations

Designations used by companies to distinguish their products are often claimed as trademarks. In all instances where Mitutoyo America Corporation is aware of a claim, the product names appear in initial capital or all capital letters. The appropriate companies should be contacted for more complete trademark and registration information.