User Guide

DuraChill Air- and Water-Cooled 1.5 HP Chillers



110-392
07 February 2020

Table of Contents

Introduction	3
General Safety Information	3
Safety Recommendations	3
Regulatory and Compliance Testing	5
Contents.....	5
Controls and Components	6
Control Panel.....	6
Front	6
Rear -- 230V, 240V, and 208-230V Units	7
Rear -- 380V and 460V Units	7
Quick Start	8
Installation and Startup	9
Site Requirements.....	9
Ambient Temperature and Relative Humidity	9
Location	9
Clearance	9
External Piping.....	10
General Considerations.....	10
Process Fluid Connections.....	11
Facility Water Connections.....	11
Reservoir Drain.....	11
Reservoir Vent.....	11
Process Coolant.....	12
Electrical Power	13
Phase Requirements (if applicable)	13
Optional Signal Inputs/Outputs	13
Ambient / External Temperature Probe.....	13
RS-232/RS-485 Serial Output	13
Remote On / Off Port.....	13
4-20mA Set Point Control.....	13
Startup.....	14
Facility Water Flow (water-cooled units only).....	14
Filling the Reservoir.....	14
Starting Process Fluid Flow.....	14
Normal Operation	15
Selecting the Temperature Unit	15
Displaying and Adjusting the Set Point.....	15
Selecting the Internal / External Temperature Display	15
Displaying and Adjusting the Ambient Tracking Offset.....	16
Displaying and Adjusting the Remote Control Temperature	16
Selecting the Pressure / Flow Rate Display and Units	16
Setting Operational Parameters / Limits	17
Display, Alarm and Error Messages	20
Adjusting the High Pressure Bypass Setting	22
Enabling / Disabling the Local Lockout	22
Over-Temperature Protection	23
Routine Maintenance	24
Routine Maintenance	24
Condenser, Air Vents and Reusable Filter	24
Inline Strainer	24







Fluid Level	24
Cleaning	24
Temperature Calibration	25
Internal Calibration Offset (c1)	25
External Calibration Offset (c2)	25
Flow Rate Calibration (Fc)	26
Fuse Bits (Fb).....	26
Troubleshooting	27
Diagnostic Mode	28
Technical Information	29
Controller Specifications	29
Performance Specifications	29
Electrical Specifications	30
Pump Performance	31
RS-232 / RS-485 Communications	32
Certificate of Compliance	33
Equipment Disposal (WEEE Directive).....	33
Service and Technical Support	33
Replacement Parts	34
Pumps	36
Warranty	37
Appendix	38
Flow Schematic - All Models.....	38
Electrical Diagrams	39
Options.....	49
General Options Wiring	49
RS-485 Communications Wiring	50
DI Control Wiring	51
H2 & H3 Option Wiring	51
4-20 mA Set Point Control.....	52

Introduction

DuraChill Chillers provide cooling power for demanding applications and serve as an economical alternative to tap water cooling systems. All models feature a microprocessor-based controller, digital Temperature Display (°C or °F), one-touch set point display, and digital Pressure/Flow Rate Display (PSI, kPa, GPM, LPM) with push-Button selection. To optimize cooling efficiency and performance, these sophisticated Chillers also feature a modulated refrigeration system. As a result, temperature stability is greatly enhanced and compressor life extended.

General Safety Information

When installed, operated, and maintained according to the directions in this manual and common safety procedures, your Chiller should provide safe and reliable temperature control. Please ensure that all individuals involved in the installation, operation, or maintenance of this Chiller read this manual thoroughly prior to working with the unit.









	This symbol alerts you to a wide range of potential dangers. When attached to the unit, consult the operator's manual.
	This symbol advises danger from electricity or electric shock.
	This symbol indicates that a hot surface may be present.
	This symbol marks information that is particularly important.
	This symbol indicates alternating current.
	These symbols on the Power Switch / Circuit Breaker indicate that they place the main power supply ON / OFF.
	This symbol on the Power Key (if present) indicates that it places the unit in a standby mode. It DOES NOT fully disconnect the unit from the power supply.

**Read all instructions pertaining to safety, set-up, and operation.
Proper operation and maintenance is the user's responsibility**

Safety Recommendations

It is the user's responsibility to read and understand all instructions and safety precautions included in this manual prior to installing or operating this equipment. Contact our Customer Service Department with any questions regarding the operation of this Chiller or the information contained in this manual.

	WARNING: Installation, operation, or maintenance of this equipment should be performed in strict accordance with the instructions outlined in this manual. Failure to follow those instructions may increase the risk of personal injury, damage the equipment, and/or void the warranty.
---	--

	WARNING: Always operate the unit within the stated temperature and pressure design specifications.
	WARNING: All warning labels should be carefully observed. Never remove or obstruct a warning label.
	WARNING: Units which use cooling fluid must be properly filled before use and properly drained before moving or service. Allow reservoir fluid to return to ambient temperature before draining. Be sure to follow your organization's procedures and practices regarding the safe lifting and relocation of heavy objects. For items weighing 18 kg or more, safe practice lifting should be performed by at least two people.
	WARNING: Service should only be performed by fully qualified personnel. Extreme caution is required as hazards are present when servicing this equipment.
	WARNING: Do not attempt to operate leaking or damaged equipment.
	CAUTION: Be sure to follow all appropriate safety and environmental guidelines when collecting and disposing of spent coolant.
	WARNING: Do not plug unit into the electrical outlet until it is ready for startup. Always connect the power cord on this unit to a grounded power outlet. Make certain that the outlet is the same voltage and frequency as your unit (see identification label). Never operate the unit with a damaged power cord. Always turn the unit OFF and disconnect mains power before performing any maintenance or service as hazardous voltages exist within chassis components.
	WARNING: Make sure the equipment's main power switch is in the OFF position before connecting or disconnecting electrical power from the unit. Follow all applicable electrical and safety codes and procedures when connecting power to the unit. Electrical connections should be made by an authorized electrical installer.
	WARNING: Disconnect electrical power before moving the unit. Keep unit upright when moving. Follow your company's procedures and practices regarding the safe lifting and relocation of heavy objects. For items weighing 18 kg or more, safe practice lifting should be performed by at least two people.

Regulatory and Compliance Testing

Canada USA (60Hz) units

CAN/CSA C22.2 No. 61010-1-12 – Safety Requirements for Electrical Equipment for Measurement, Control and Laboratory Use, Part I: General Requirements.

CAN/CSA C22.2 No. 61010-2-010-04 (R2014) – Safety Requirements for Electrical Equipment for Measurement, Control and Laboratory Use – Part 2-010: Particular Requirements for Laboratory Equipment for the Heating of Materials.

UL Std No. 61010-1 (2012) – Safety Requirements for Electrical Equipment for Measurement, Control and Laboratory Use – Part 1: General Requirements.

UL Std No. 61010-2-010 (2015) – Safety Requirements for Electrical Equipment for Measurement, Control and Laboratory Use – Part 2-010: Particular Requirements for Laboratory Equipment for the Heating of Materials.

CE (50Hz units)

Machinery Directive 2006/42/EC

EC Electromagnetic Compatibility Directive 2014/30/EU

IEC 61010-1 / EN 61010-1:2010

IEC 61010-2-010 / EN 61010-2-010:2014

IEC 61326:2012 / EN 61326:2013

RoHS Directive 2011/65/EU

Australia/New Zealand (50 Hz)

ACMA – Radiocommunications (Electromagnetic Compatibility) Standard 2008 EN 61326-1:2013

EAC Customs Union (50 Hz)

TP TC 010/2011 On Safety of Machinery and Equipment

TP TC 004/2011 On Safety of Low Voltage Equipment

TP TC/020/2011 Electromagnetic Compatibility of Technical Equipment

Highly Accelerated Life Test (HALT) and Vibration Tests per ASTM D4169-8 (All units)

Contents

The following items have been included with your Chiller:

- Operator's Manual
- Two sets of Inlet/Outlet Adapters: ½ inch male NPT x ½ inch hose barb and ½ inch male NPT x 5/8 inch hose barb (select models)

Controls and Components

Control Panel

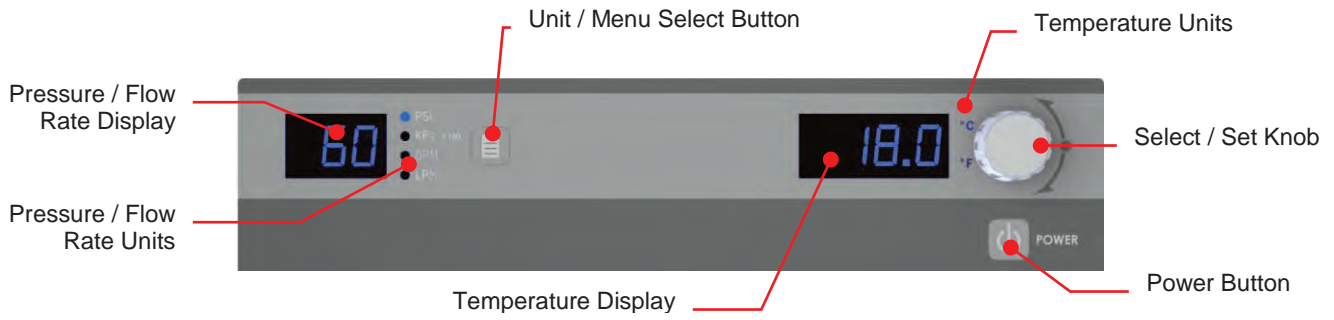

Front



Rear – 230V, 240V, and 208-230V Units

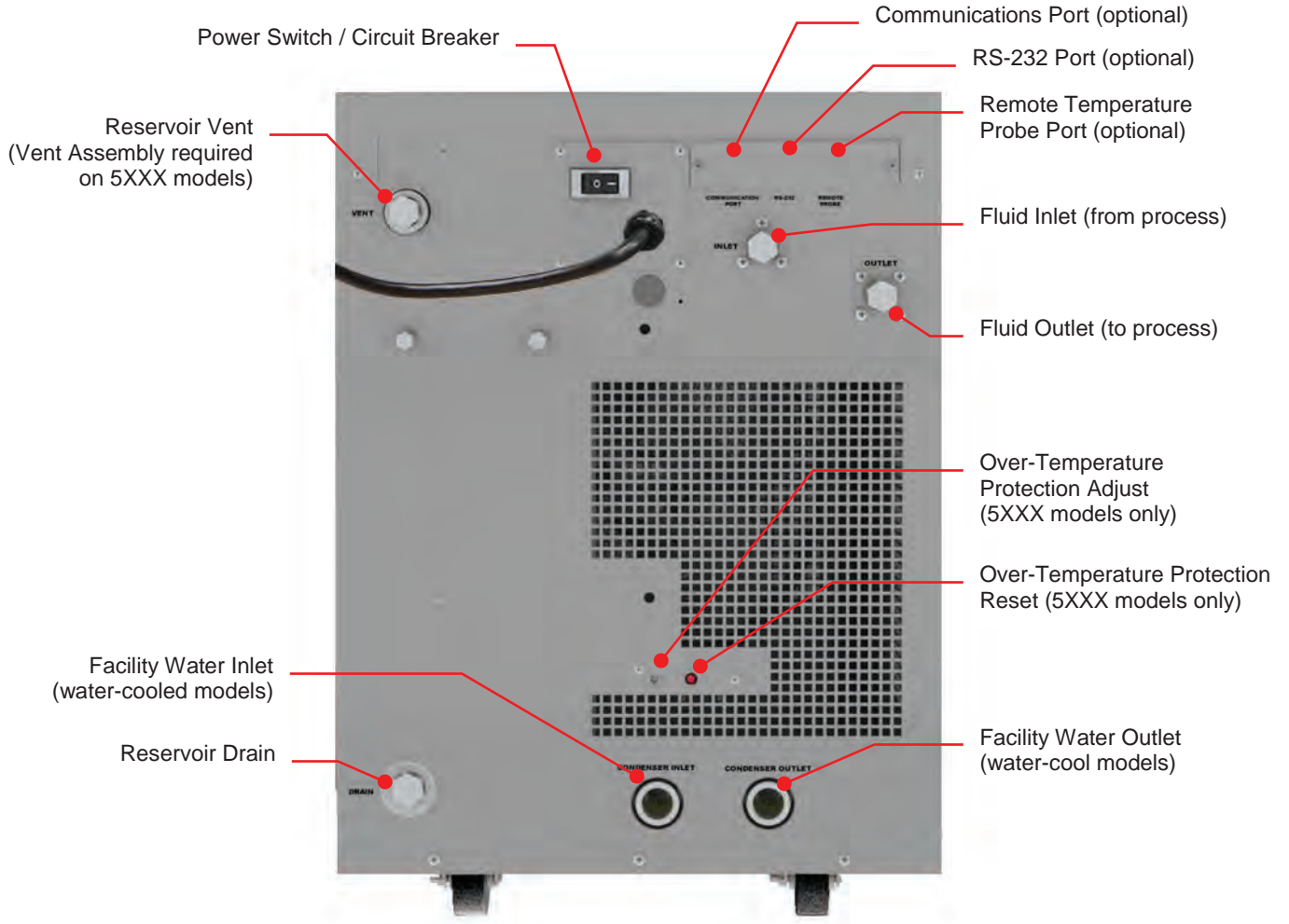

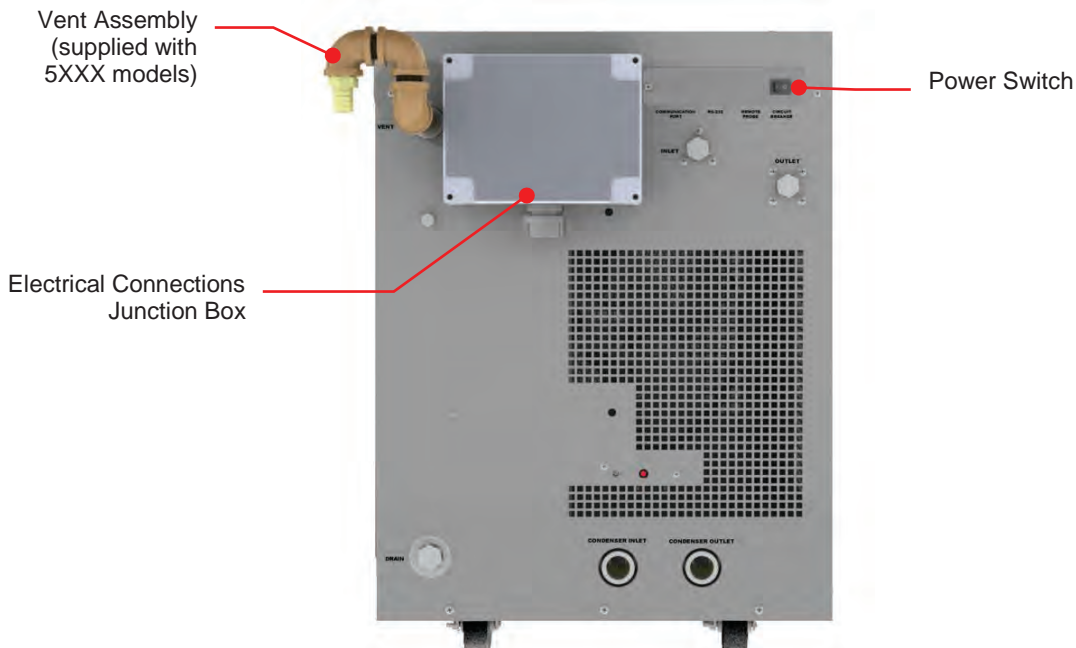

Rear – 380V and 460V Units

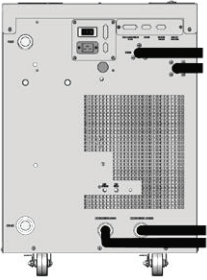
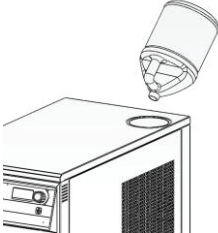
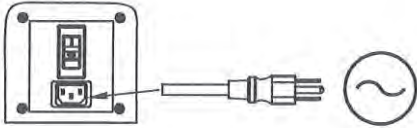
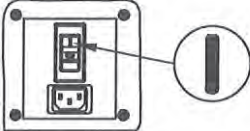
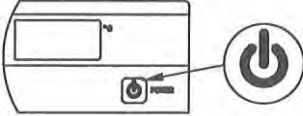
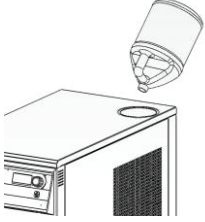

Quick Start

See Installation & Startup for additional information.

<p>1</p>	<p>All units: Connect process lines</p> <p>Water-cooled units: A. Connect process lines B. Connect facility water lines C. Turn facility water ON</p>	
<p>2</p>	<p>Fill reservoir with coolant</p>	
<p>3</p>	<p>Connect electrical power to Mains</p>	
<p>4</p>	<p>Turn Power Switch / Circuit Breaker ON</p>	
<p>5</p>	<p>Turn Controller ON</p>	
<p>6</p>	<p>Add coolant to reservoir as process lines fill</p>	
<p>7</p>	<p>Enter temperature set point</p>	

Installation and Startup

Site Requirements

Ambient Temperature and Relative Humidity

The Chiller is designed for indoor installation in ambient temperatures between 16° and 35°C (60° and 95°F); relative humidity should not exceed 80% (non-condensing).

Location

Install the Chiller on a strong, level surface as close to possible to the process requiring cooling. It should not be installed closer than 4 feet (1.4 meters) to a heat-generating source. If possible, the unit should be located near a suitable drain to prevent flooding in the event of leaks. Do not place it where corrosive fumes, excessive moisture, excessive dust, or high room temperatures are present.

Position the Chiller as close as possible to the power distribution panel. Avoid voltage drops by using a properly grounded power source wired to meet electrical data plate requirements. The use of an extension cord is not recommended.



NOTE: The unit may be located at a level below that of the equipment being cooled. As long as the process remains closed, overflow will not occur when adding cooling fluid to the unit's reservoir.

Clearance

Allow adequate clearance on the front, sides, and rear of the Chiller for access to connections and components. The front and rear vents of the Chiller must be a minimum of 24 inches (61 cm) away from walls or vertical surfaces so air flow is not restricted.

External Piping

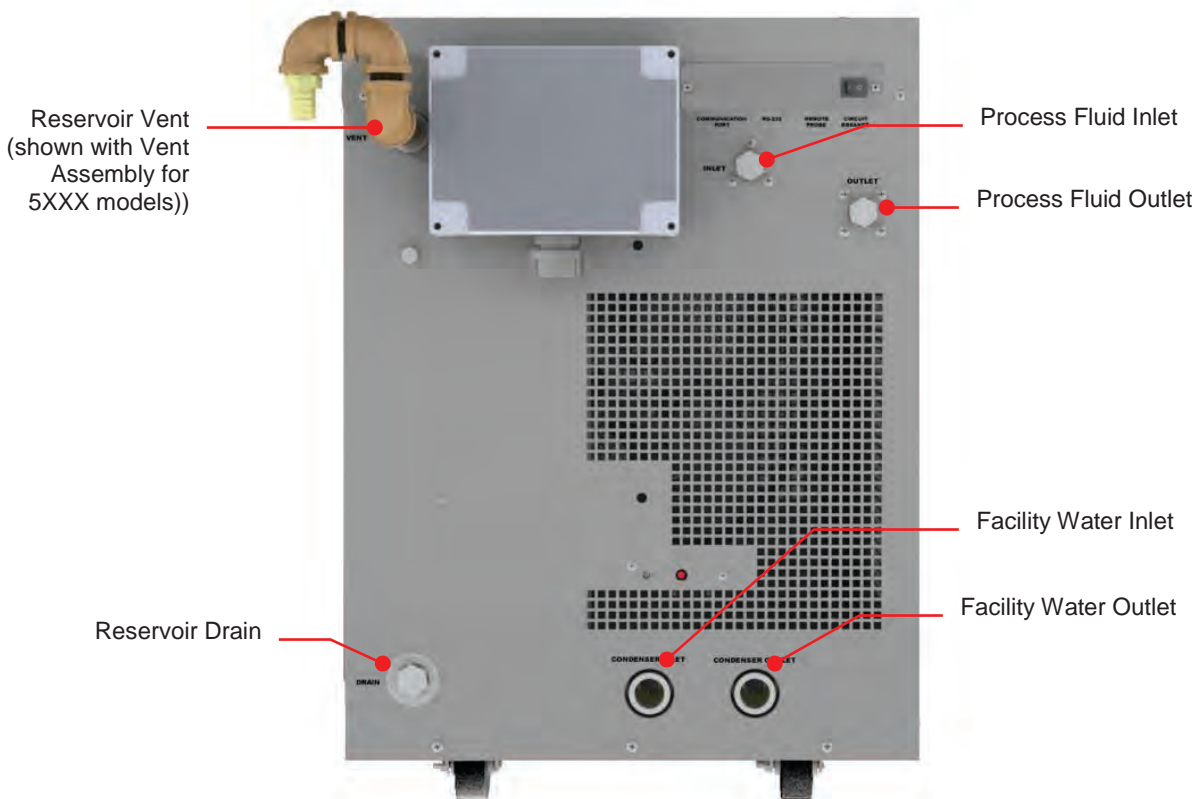

General Considerations

It is the user's responsibility to ensure that the tubing and fittings connected to the Chiller are compatible with the fluid, temperature, and pressure being used.

- All external piping, tubing, or hoses should be run full size to limit the potential for external pressure drops. The use of quick-connect fittings is not recommended, as they can cause substantial pressure drops.
- Materials of construction should be compatible with the fluid being used as well as the temperature and pressure at which the unit will operate.
- Where applicable, always use a back-up wrench when making piping connections to the Chiller.
- Pressure Ratings – Hoses should be able to withstand the highest pressure that they will encounter (100 psi / 6.9 bar).
- Flexible Tubing – Avoid tubing that will expand and increase fluid volume when operating at the desired pressure.
- Hose Diameter – The fittings on the Chiller's process fluid lines are female 0.5 in NPT. The facility water fluid inlets and outlets on water-cooled models are female 0.75 inch NPT.
- Facility Water (water-cooled models only) – Should be clean and well maintained. Ideally, the facility water should be tested monthly to ensure a pH level between 7.2 and 7.8. Add algacide if algae growth is present.

Process Fluid Connections

The Chiller has two internally threaded fittings on the rear of the instrument housing for the process water connections. Two sets of adapters are supplied with the unit for connecting these fittings to the process piping.

The direction of the flow through the system can be controlled by the way the connections are made. Fluid is drawn into the Chiller through the “Inlet” connection; fluid is pumped out of the Chiller through the “Outlet” connection.



NOTE: When Chillers with the standard magnetic drive centrifugal pump are connected to an external apparatus with a built-in shutoff, an external bypass loop assembly (Part No. 510-147) may be needed if operating below 20°C (68°F). This bypass assembly continues flow circulation to and from the pump even though the main flow to the external apparatus has been blocked.

Facility Water Connections



WARNING: On units requiring facility water, those connections must be made by a licensed plumber.



CAUTION: The incoming cooling water pressure should be 20 psi / 1.4 bar minimum and 150 psi / 10.3 bar maximum.

Water-cooled Chillers have two internally threaded fittings on the rear of the instrument housing for the facility water connections. The cooling water supply should be connected to the facility water inlet on the Chiller. The facility water outlet on the Chiller should be connected to the appropriate return or drain, as required.

The cooling water supply may be from city tap water or a cooling tower. The incoming water pressure should be between 20 and 150 psi / 1.4 and 10.3 bar.

Reservoir Drain

A connection is provided for the reservoir’s gravity drain.

Reservoir Vent

A reservoir vent assembly is provided with Chillers equipped with the heater option to relieve pressure within the reservoir as coolant heats and expands. A connection is provided on the rear of the Chiller for the vent assembly.

Process Coolant

Suitable Fluids

	<p>WARNING: For units that use cooling fluids. Use only fluids that comply with safety, health, and equipment compatibility requirements. Read the safety data sheet for the fluid being used carefully before use.</p> <p>CAUTION: DO NOT USE</p> <ul style="list-style-type: none">Caustic, corrosive, or flammable liquidsAutomotive anti-freeze*Hard tap water*Deionized water with a specific resistance >1 meg ohmConcentrations of acids or basesSolutions with halides: chlorides, fluorides, bromides, iodides, or sulfurChlorine bleachGlycerineSyltherm fluids <p>* At temperatures above 40°C, additives or mineral deposits can adhere to the heater. If deposits are allowed to build up, the heater may overheat and fail. Higher temperatures and higher concentrations of additives will hasten mineral deposits</p>
---	--

The Chiller can accommodate a variety of coolant fluids (water, glycol mixtures, etc). For most applications above 20°C (68°F), distilled water is satisfactory. For operation below 20°C (68°F), the Chiller must be protected with an antifreeze solution. Ethylene glycol (laboratory grade) and water in a 50/50 mixture is satisfactory from +20° to -15°C (68° to 5°F). Select a fluid that is compatible with the Chiller's wetted parts (brass, bronze, stainless steel, EPDM rubber, nylon, PVC).

	<p>WARNING: Operation below 20°C (68°F) requires antifreeze in the circulation fluid. Do not use automotive antifreeze as the additives may be harmful to the Chiller's wetted parts.</p>
---	--

Electrical Power

	<p>WARNING:</p> <p>Do not plug unit into the electrical outlet until it is ready for startup.</p> <p>Always connect the power cord on this unit to a grounded power outlet. Make certain that the outlet is the same voltage and frequency as your unit (see identification label). Never operate the unit with a damaged power cord.</p> <p>Always turn the unit OFF and disconnect mains power before performing any maintenance or service as hazardous voltages exist within chassis components.</p>
---	---

	<p>WARNING: Make sure the equipment's main power switch is in the OFF position before connecting or disconnecting electrical power from the unit. Follow all applicable electrical and safety codes and procedures when connecting power to the unit. Electrical connections should be made by an authorized electrical installer.</p>
---	---

	<p>WARNING: DO NOT apply power until the unit is ready for Startup.</p>
---	--

Connect the power cord (if) supplied with the Chiller to an appropriate electrical outlet.

Phase Requirements (if applicable)

For 3-phase units, be sure to connect in proper sequence, ie.: L1, L2, and L3. These Chillers are designed with a junction box on the rear of the unit to which you can connect the electrical power supply conduit. Be sure to provide suitable conduit strain relief and grounding.

3-phase units are equipped with a phase monitor that prevents startup if phase sequence is incorrect. The Chiller will turn OFF in the event of a loss of one phase and/or prevent operation if there is a voltage mismatch between any two phases greater than 8%.

Optional Signal Inputs/Outputs

Ambient / External Temperature Probe

Allows control of the cooling fluid temperature using an external temperature measurement (ambient room/machine temperature or process temperature). A 9-pin connector is provided for connecting the ambient/external tracking probe.

	<p>NOTE: In order for the Chiller to properly recognize the presence of the external temperature probe, the probe must be connected to the unit before power is applied..</p>
---	--

RS-232 / RS-485 Serial Output

Allows remote control the Chiller and/or the output of temperature readings to an external auxiliary device. The maximum communications distance for Chillers equipped with the RS232 option is 50 feet (15 meters). The maximum distance for units equipped with the RS485 option is 4000 feet (1200 meters). A 9-pin D-connector is provided for this connection.

Remote On / Off Port

Allows the connection of a remote On/Off switch or other remote control device to the Chiller. A 15-pin D-connector is provided on the rear of the instrument enclosure for this connection.

4-20mA Set Point Control

Allows set point changes using a customer supplied current value. A 15-pin D-connector or 8-pin circular connector is provided for this connection.

Startup

Facility Water Flow (water-cooled units only)

1. Open the valves to the facility water supply and return.
2. Check for leaks.

Filling the Reservoir

1. Remove the reservoir cap located on the top of the Chiller and, using a funnel, add fluid until it is approximately 2 inches (5.1 cm) below top of reservoir.
2. Once the fluid level is about 2 inches (5.1 cm) below the top of the reservoir, remove the funnel but do not replace the cap at this time.

Starting Process Fluid Flow

1. Place the circuit breaker located on the rear panel of the Chiller to the ON position. The display on the front panel will respond by showing standby (....). If there is no response, check that the unit is connected to working electrical power and that circuit breaker on the rear of the Chiller is in the ON position.
2. Press the Power Button on the front panel. The system startup sequence will begin and proceed as follows:
 - The pump will turn on and fluid will begin circulating through the system.
 - The set point temperature will appear briefly on the Temperature Display; after a few seconds, it will be replaced by the actual fluid temperature.
 - 15 to 20 seconds after power up, the compressor will begin operating.



NOTE: When adding fluid to the unit for the first time, prime the pump by pressing the Power Button to turn power ON, letting the Chiller run for 3 seconds, and the pressing the Power Button again to turn power OFF. Repeat this ON and OFF procedure three times.

3. Check for leaks.
4. With the pump running, the reservoir's fluid level will drop as the process and/or process cooling lines fill with fluid. Slowly add fluid to the reservoir until the liquid level remains stable.
5. Replace the reservoir cap.

Normal Operation



NOTE: The Chiller incorporates a special "lockout" feature that can be enabled to prevent unauthorized or accidental set point and other operational changes. This feature is described in detail under "*Enabling and Disabling the Local Lockout.*" It should not be enabled until all operational parameters have been set.

Selecting the Temperature Unit (°C or °F)

The LEDs adjacent to the Temperature Display indicate the unit (°C or °F) used for Temperature Displays. To change from °C to °F or vice versa, proceed as follows:

To change to °F — Place the Circuit Breaker/Power Switch on the rear of the instrument in the OFF position. Press and hold the Units/Menu Select Button while returning the Circuit Breaker/Power Switch to the ON position.

To change to °C — Place the Circuit Breaker/Power Switch on the rear of the instrument in the OFF position. Press and hold the Power Button on the front panel while returning the Circuit Breaker/Power Switch to the ON position.



IMPORTANT: All user settings, except baud rate and calibration offset, return to the original factory defaults when the temperature unit is changed. The Chiller's temperature set point and various alarm settings should be reset to desired values.

Displaying and Adjusting the Set Point

Press the Select/Set Knob on the front panel. The current set point temperature will be displayed, and the decimal point at the bottom right of the display will flash, indicating that the temperature can be changed.

Rotate the Select/Set Knob until the desired set point temperature is displayed. The setting is accepted after the Select/Set Knob is pressed a second time or automatically after a few seconds of inactivity.



NOTE: Temperature set point cannot be changed when the local lockout is enabled or remote temperature control is installed and enabled. It allows the user to check or continuously display either the Chiller's internal outlet fluid temperature or the external ambient/process temperature.

Selecting the Internal / External Temperature Display



NOTE: This section applies only when the ambient tracking probe or remote temperature control is installed and enabled. It allows the user to check or continuously display either the Chiller's internal outlet fluid temperature or the external ambient/process temperature.

When the ambient tracking probe is selected (AtC), the Chiller normally displays the internal outlet fluid temperature. To display the external ambient temperature, press and release the Units/Menu Select Button until P2 appears on the Pressure/Flow Rate Display.

When the remote temperature control probe is selected (rPC), the Chiller normally displays the external process temperature. To display the internal outlet fluid temperature, press and release the Units/Menu Select Button until P1 appears on the Pressure/Flow Rate Display.



NOTE: P1 or P2 will remain on the pressure/flow rate display until the Units/Menu Select button is pressed and released. The displayed temperature will revert to the default condition (internal temperature for the ambient probe, external temperature for the remote temperature control probe).

Displaying and Adjusting the Ambient Tracking Offset



NOTE: Ambient tracking is an optional function that may or may not be available on your Chiller. It permits you to control fluid temperature based on room or machine temperature plus or minus a user-adjustable offset temperature.

When the optional ambient tracking probe is installed and enabled (AtC), the ambient tracking offset rather than the set point temperature is displayed when the Select/Set Knob on the front panel is pressed.

To change the displayed offset value, rotate the Select/Set Knob until the desired offset value is displayed. An offset value from -5.0°C to $+5.0^{\circ}\text{C}$ (-9.0° to $+9.0^{\circ}\text{F}$) may be entered. The setting is accepted after the Select/Set Knob is pressed a second time or automatically after a few seconds of inactivity.

Displaying and Adjusting the Remote Control Temperature



NOTE: Remote temperature control is an optional function that may or may not be available on your Chiller. It permits you to control cooling based on the temperature of the external process.

When the optional remote control external probe is installed and enabled (rP), the external temperature set point is displayed when the Select/Set Knob on the front panel is pressed.

To change the external temperature set point, press and then rotate the Select/Set Knob until the desired set point temperature is displayed. The setting is accepted after the Select/Set Knob is pressed a second time or automatically after a few seconds of inactivity.

Selecting the Pressure / Flow Rate Display and Units

The Chiller can set to display either fluid pressure (in PSI or kPa) or flow rate (in GPM or LPM). Pressing the Units/Menu Select Button briefly toggles through the available selections.



NOTE: Metric pressure reading output is displayed in kPa and must be multiplied by 100 for Pa.



NOTE: The flow rate readout is intended as a reference only. If accurate flow readings are required, an external flow meter is recommended.

Setting Operational Parameters / Limits

Various operational parameters are user-adjustable. They are accessed by pressing and holding the Units/Menu Button until HL appears on the Pressure/Flow Rate Display. Pressing and releasing the Units/Menu Button once HL appears allows you to scroll through the various parameters; rotating the Select/Set Knob allows you to change the displayed setting. You can accept the displayed value by either pressing the Select/Set Knob or allowing the display to timeout.

Operational parameter limit alarms will shut down the compressor, fan, pump and heaters. Some temperature values are only displayed and settable in °C



NOTE: Some parameters listed may not be included in your version of software.



NOTE: The ranges and default settings shown are for standard models. Ranges and default settings for your unit may differ depending on the options selected.

Menu Item	Description	Choices / Ranges	Default Setting
HL	<p>High Temperature Limit — Limits the maximum allowable set point temperature. Audio and visual alarm indicators are activated when the measured fluid temperature reaches the HL temperature setting.</p> <p>NOTE: EHL will appear on the display if the High Limit value is set below the current set point.</p>	<p>Units without heater option (6xxx) = +20 to 40 °C (68 to 104°F)</p> <p>Units with heater option (5xxxx) = +20 to 95 °C (68 to 203°F)</p>	<p>6xxx = 40 °C 5xxx = 95 °C</p>
LL	<p>Low Temperature Limit — Limits the minimum allowable set point temperature. Audio and visual alarm indicators are activated when the measured fluid temperature reaches the LL temperature setting.</p> <p>NOTE: ELL will appear on the display if the Low Limit value is set above the current set point.</p>	<p>0.0 to +15 °C (32 to 59 °F)</p>	<p>5.0°C</p>
HA	<p>High Ambient Temperature Limit — Maximum ambient temperature limit. Displayed and settable only in °C. Should the ambient temperature rise above the HA value, the audio and visual alarms will activate and the compressor, heater, fan, and pump will turn OFF.</p> <p>NOTE: Chiller's rated cooling capacity is dependent on an ambient temperature of 20°C (68°F). Performance will decrease as the ambient temperature rises. Continuous operation at ambient temperatures above 40°C (104°F) is not recommended.</p>	<p>+30 to 50°C</p>	<p>40 °C</p>

Menu Item	Description	Choices / Ranges	Default Setting
FP	<p>Maximum Fluid Pressure — Maximum allowable fluid pressure; settable in either PSI or kPa. Should the fluid pressure rise above the maximum fluid pressure value, the audio and visual alarms will activate and the compressor, heater, fan, and pump will turn OFF.</p> <p>NOTE: The Chiller also incorporates a built in pressure regulated bypass valve. It will maintain a maximum outlet pressure by diverting flow of the process fluid to the reservoir. The bypass valve may be adjusted by the customer.</p> <p>CAUTION: Maximum operating pressure for the Chiller is 100 PSI / 6.9 bar. Different pumps have different maximum operating pressures.</p>	<p>20 to 100 PSI 13 to 680 kPa (display value x 100)</p>	<p>80 PSI 5.5 x 100 = 550 kPa</p>
FL	<p>Minimum Flow Rate — Minimum allowable flow rate; settable in either GPM or LPM. Should the fluid flow rate drop below the minimum value, the audio and visual alarms will activate, and the compressor, heater, fan, and pump will turn OFF.</p>	<p>0 and 1.5 to 3 GPM 0 and 6 to 11 LPM</p>	<p>1.5 GPM 6.0 LPM</p>
AF	<p>Auto-Refrigeration Set Point — The upper temperature at which the refrigeration system will activate; displayed and settable in °C only. There will be no refrigeration or cooling at set points above the AF setting.</p>	<p>+20° to 40°C</p>	<p>35°C</p>
Sd	<p>Maximum External / Internal Temperature Differential (optional) — Establishes the cooling/heating rate when the remote temperature control probe is installed and enabled.</p>	<p>4° to 20°C</p>	<p>5°C</p>
rP	<p>Ambient Tracking / Remote Probe (optional)</p> <p>AtC — Ambient tracking probe enabled. Chiller controls fluid temperature based on room or machine temperature (wherever the ambient tracking probe is located) plus or minus a user-set offset ($\pm 5.0^{\circ}\text{C}$ / $\pm 9.0^{\circ}\text{F}$).</p> <p>rPC — Remote probe enabled. Chiller controls fluid temperature based on the process fluid temperature at an external location.</p> <p>nO — Ambient tracking / remote probe disabled.</p> <p>nRP — Ambient tracking probe not installed.</p>	<p>Dependent on option and software installed.</p>	<p>nAP</p>
C1 / C2	<p>Calibration Offset — Allows adjustment of the displayed temperature to match that of an independent traceable standard; displayed and settable in °C only.</p> <p>C1 — Internal calibration offset</p> <p>C2 — External calibration offset</p>	<p>$\pm 2.9^{\circ}\text{C}$</p>	<p>0.0°C</p>
Fc	<p>Flow Rate Calibration — Allows adjustment of the displayed flow rate to match that of a known standard.</p>	<p>Note value here for reference/replacement of PCB or flow sensor</p>	<p>Varies</p>

Menu Item	Description	Choices / Ranges	Default Setting
CC	Current Control (optional) — Allows setting of the set point temperature via a 4-20 mA analog signal. yES — Enables current control. NO — Disables current control.	Yes or No	No
PC	Communications Baud Rate — Selects the baud rate for serial (RS232/RS485) communication.	24 (2400), 48 (4800), 96 (9600) or 192 (19200)	9600

The current Fuse Bits (Fb) setting appears after the PC setting and can be viewed, but not changed. To change Fuse Bits (Fb) operational parameters, electrical power must be turned OFF and a special key stroke combination entered. See *Fuse Bits (Fb)* for detailed instructions.

Fb Fuse Bits	Input	Logic State	h00	h01	h02	h04	h05	h06
	Remote ON / OFF dry contact	Closed		Off	On	N/A	Off	On
Open			On	Off	On		Off	
24 VDC Remote Control Voltage	24 VDC		Off	Off	On	Off	N/A	On
	0 VDC		On	On	Off	On		Off
Water Level Float Switch	Open		OK	OK	OK	Low	Low	Low
	Closed		Low	Low	Low	OK	OK	OK

Display, Alarm and Error Messages

When certain conditions are detected, a message code flashes on the display and the local audio alarm sounds. Depending on the nature of the condition, power to various systems components is removed. When the condition is rectified, push the front panel Power Button or turn the circuit breaker OFF then ON to clear the fault or error.

Message Code	Description	Action Required
EFL	<p>Low fluid level warning — units with fluid level float switch.</p> <p>Fluid flow too low warning — units with flow switch (PO - no pump – no reservoir option).</p>	<p>Warning / Alarm — Fluid level or flow switch is open. Alarm will sound once every 8 seconds for 5 occurrences. If problem has not been corrected after 40 seconds, Fault 05 occurs.</p> <p>Add fluid to the reservoir.</p>
EHA	High ambient temperature warning	<p>Warning / Alarm - The ambient temperature (as measured on the Control PCB) is higher than the set ambient limit. The display alternates between EHA and the fluid temperature; the unit continues normal operation. If the ambient temperature stays over 5°C above the high ambient limit for more than 5 seconds, Fault 16 occurs.</p> <p>Lower ambient temperature or raise high ambient temperature limit.</p>
EHL	High limit temperature alarm	<p>Warning / Alarm — The temperature set point is higher than the high temperature limit value. The display alternates between EHL and the fluid temperature; the unit continues normal operation. If the fluid temperature stays above the HL value for more than 25 seconds, Fault 03 occurs.</p> <p>Lower temperature set point or increase high limit value.</p>
ELL	Low temperature limit alarm	<p>Warning / Alarm — The temperature set point is lower than the low temperature limit value. The display alternates between ELL and the fluid temperature; the unit continues normal operation. If the fluid temperature stays below the LL value for 25 seconds, Fault 02 occurs.</p> <p>Increase temperature set point or decrease low limit value.</p>
LO-H2O	No fluid flow and no fluid pressure	<p>Warning / Alarm — LO is displayed alternately with H2O and fluid temperature if there is no fluid pressure and the fluid flow is less than the low flow limit. If both conditions last for 3-4 minutes, Fault 07 alarm will occur and the compressor, heater, fan, and pump are turned OFF.</p>
LLO	Local Lockout	<p>Normal — Indicates that Local Lockout feature (see <i>Enabling / Disabling the Local Lockout</i>) is enabled. Appears momentarily when Select/Set Knob is pressed to view/change set point value.</p>
CAn	Cancel Local Lockout	<p>Normal — Indicates the Local Lockout feature (see <i>Enabling / Disabling the Local Lockout</i>) has been disabled. Appears momentarily when Local Lockout status is changed from enabled (LLO) to disabled.</p>
EC	External remote control active	<p>Normal — Chiller is in Standby mode until remotely activated (optional).</p>
EF2	Fluid level in reservoir low	<p>Warning / Alarm — <i>Units with Dual Float Option only.</i> Indicates that the fluid level has fallen below the lower float. When the EF2 warning/alarm appears, there will be a short delay and then the Chiller will turn OFF.</p>

If a fault should occur, the left display will show Ft, and the right display will show one of the fault codes shown below.

Fault Code	Description	Action Required
02	Low limit temperature alarm	Alarm — Process fluid temperature is below the low temperature limit value for more than 25 seconds. Compressor, heater, and fan are turned OFF; pump remains ON. To clear the fault, turn the unit off then on using the front panel Power Button, and decrease the LL value.
03	High limit temperature alarm	Alarm — Process fluid temperature is above the high temperature limit value for more than 25 seconds. Compressor, heater, and fan are turned OFF; pump remains ON. To clear the fault, turn the unit off then on using the front panel Power Button, and increase the HL value.
04	Over-temperature alarm	Alarm — Process fluid temperature is above Chiller's factory set high temperature safety cutoff. Heater, compressor, and fan turned OFF; pump remains ON. Lower process temperature.
05	Low liquid level alarm (select models only)	Delayed Alarm — Activated when the liquid level in the reservoir falls below an acceptable level for over 40 seconds. Compressor, heater, fan, and pump are turned OFF. Add fluid to reservoir.
07	Low flow alarm	Alarm — Flow rate has dropped below minimum flow rate setting for more than 10 seconds. Compressor, heater, fan, and pump are turned OFF. Note: Disabled during first 2 minutes of operation. Correct cause of low flow rate or decrease minimum flow rate setting.
08	High pressure alarm	Alarm — Fluid outlet pressure has exceeded high-pressure limit value for over 10 seconds. Compressor, heater, fan, and pump are turned OFF. Decrease outlet pressure by removing blockage or increase high-pressure limit value.
09	Internal software fault	Fault — One or more settings are out of range. Compressor, heater, fan, and pump are turned OFF. Default unit to °C or °F; if fault persists, contact service representative.
10	Electronic power component fault (Triac)	Fault — Heater triac has failed for more than 10 seconds. Compressor, heater, fan, and pump are turned OFF. Contact service representative.
11	Internal probe fault	Fault — Main temperature control probe has failed for more than 4 seconds. Compressor, heater, fan, and pump are turned OFF. Contact service representative.
12	External temperature probe fault (select models only)	Fault — External temperature control probe has failed for more than 4 seconds. Compressor, heater, fan, and pump are turned OFF. Replace ambient tracking probe or operate instrument using internal temperature probe. Contact service representative if fault persists.
18	Input – Out of Range	4-20 mA Option — Input for temperature set point too high or too low. Correct input or switch to standard control.

Adjusting the High Pressure Bypass Setting

Chillers with a positive displacement or turbine pump incorporate an automatic safety to maintain outlet pressure below a valve-regulated pressure. This valve is adjustable and is located inside the Chiller housing.



WARNING: Service should only be performed by fully qualified personnel. Extreme caution is required as hazards are present when servicing this equipment.

To access the high-pressure bypass valve, remove the access panel on the top of the unit (rear left).

The high-pressure bypass is adjusted as follows:

1. Set the low flow rate alarm value to zero (see *Setting Operational Parameters, Minimum Flow Rate*). This will prevent the unit from activating the flow alarm while you are adjusting the maximum pressure setting.
2. Completely block the Chiller's outlet flow. This should cause the outlet pressure to rise.
3. Set the Pressure/Flow Rate Display to read either PSI or kPa.
4. Rotate the handle on the pressure valve until the desired maximum pressure setting is shown on the Pressure/Flow Rate Display.
5. Secure the Locknut.
6. Reset the flow alarm value to the previous setting.
7. Return the Pressure/Flow Rate Display to the previous setting.
8. Replace the access panel.

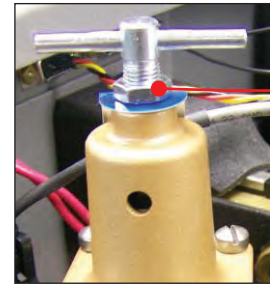

Enabling / Disabling the Local Lockout

This feature is used to prevent unauthorized or accidental changes to set point and other operational values. When enabled, the values for the following functions can be displayed, but not changed:

- Temperature unit
- Temperature set point
- Ambient tracking offset
- Pressure / flow rate units

To enable the local lockout, press and hold the Select/Set Knob until LLO is displayed. Once enabled, LLO will appear momentarily when the Select/Set Knob is pressed to display the set point.

To disable the local lockout, press and hold the Select/Set Knob until CAn appears momentarily as local lockout status changes from enabled (LLO) to disabled.



IMPORTANT: The Local Lockout feature does not prevent set point changes entered via the RS232 interface or 4-20 mA inputs.

Over-Temperature Protection

6XXX Chillers — The OTP for 6XXX model Chillers is fixed at a cutout temperature of 60°C. The OTP will auto-reset once the fluid temperature drops below the cutout temperature.

5XXX Chillers — The OTP for 5XXX model Chillers with the heater option is adjustable and disconnects power to the heater at a factory-set temperature of 95°C. The OTP is reset by pressing the red button located on the rear panel of the Chiller. If required, the cutout temperature may be adjusted using the OTP cutout temperature adjustment screw located to the left of the red reset button. To change the OTP cutout temperature, rotate the adjustment screw clockwise until it stops, bring the fluid temperature to the desired cutout temperature, and then rotate the adjustment screw counterclockwise until the OTP opens. 95°C is the maximum cutout temperature.

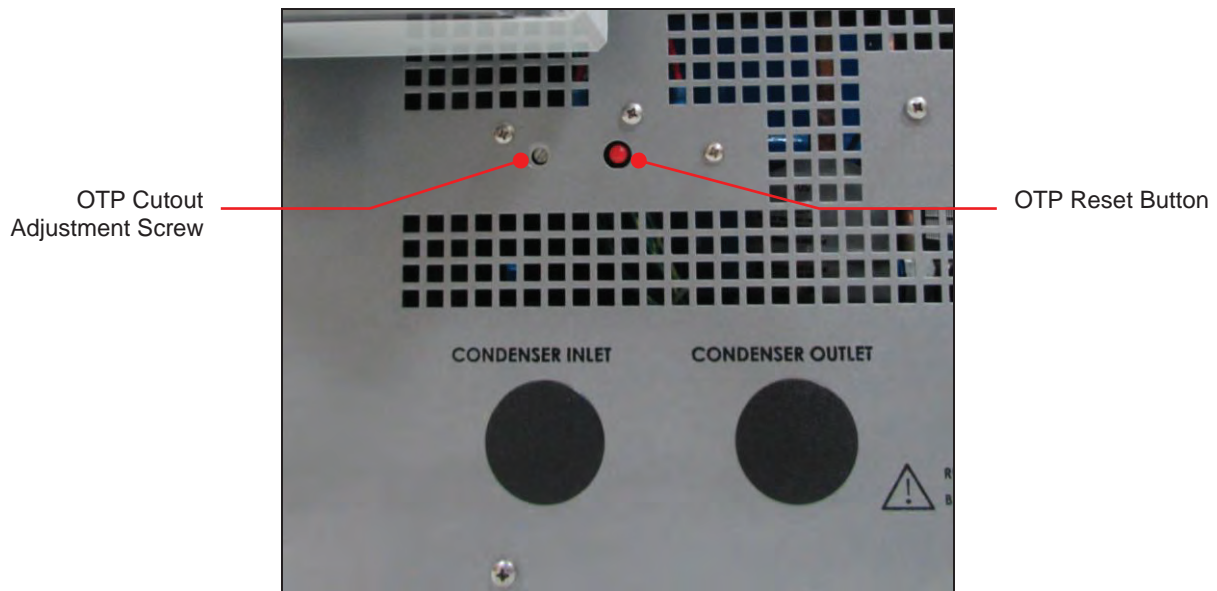

OTP Adjustment Screw and Reset — 5XXX Chillers only



IMPORTANT: The range of the OTP cutout on 5XXX model Chillers is approximately 60° to 110°C. However, the OTP cutout should never be set above the factory-set temperature of 95°C.

Routine Maintenance

Routine Maintenance

The Chiller is designed to require a minimum of periodic maintenance.

Condenser, Air Vents and Reusable Filter

The condenser, the air vents, and reusable filter should be kept free of dust and dirt. They should be checked on a regular basis and cleaned as required.

The reusable filter is accessed from either the left or right side of the unit. Use a mild detergent and water solution to wash off any accumulated dust and dirt. Rinse and dry thoroughly before reinstalling.

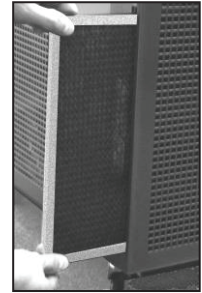

Inline Strainer

An inline strainer with 20 mesh stainless steel screen is located on the inlet to the heat exchanger. To access, remove the Chiller's top cover (attached at the rear of the unit with two screws). Remove the threaded cap, pull the screen out of the fitting, rinse off any particulate material, and reinstall. Be sure to check for leaks after reinstalling.

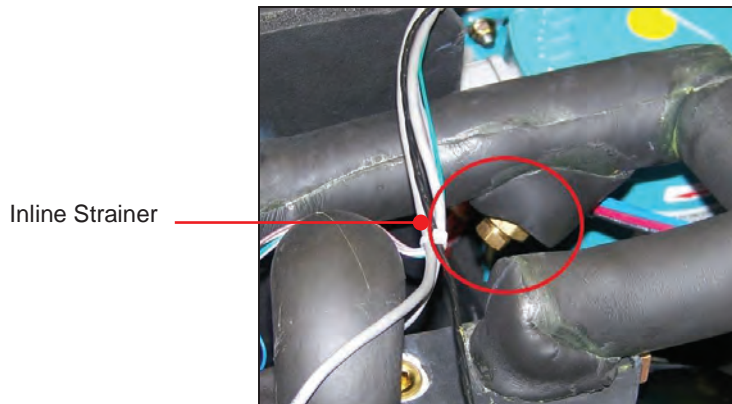

Fluid Level

The fluid level should be periodically checked to determine if the fluid level needs to be topped off. Generally, fluid should be added whenever the level in the reservoir is 2 inches (5.1 cm) below the top of the reservoir.



NOTE: On units equipped with the heater option, check fluid level when operating at maximum temperature and allow for fluid expansion. Use of a venting assembly (see "Controls and Components") is recommended.

Cleaning

Only mild detergents and water or an approved cleaner should be used on the painted and stainless steel surfaces of the Chiller. Do not allow cleaning liquids or sprays to enter the Controller vents.

Temperature Calibration

At times, there may be a minor temperature difference between the Chiller's displayed temperature and the actual temperature as determined by a certified temperature measurement device. There may also be situations where you want the displayed temperature to match a particular value to have standardization between different instruments. These adjustments can be performed using the Chiller's internal and/or external temperature calibration offset functions.

Internal Calibration Offset (°C1)

	IMPORTANT: To prevent the operator from accidentally changing the calibration offset, a special keystroke sequence is required to access this function.
---	--

This menu item allows you to adjust the Chiller's internal temperature reading to match that of a traceable standard. It allows you to offset the displayed temperature value by as much as $\pm 2.9^{\circ}\text{C}$.

	NOTE: Calibration offset values are always set and displayed in $^{\circ}\text{C}$.
---	---

1. Press and hold the Units/Menu Button until HL appears on the display.
2. Press and release the Units/Menu Button until rP appears on the display.
3. Press and hold the Units/Menu Button.
4. While holding the Units/Menu Button, press and release the Select/Set Knob.
5. When CL1 appears on the Temperature Readout, release the Units/Menu Button. The current calibration offset value will appear on the Temperature Readout and alternate with the fluid temperature reading (enabling you to simultaneously adjust the offset and see the effect on the temperature).
6. Rotate the Select/Set Knob until the desired calibration offset is displayed. Press the Select/Set Knob or simply allow the display to time out to accept the displayed value.

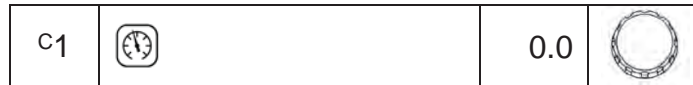

External Calibration Offset (°C2)

	IMPORTANT: To prevent the operator from accidentally changing the calibration offset, a special keystroke sequence is required to access this function.
---	--

This menu item allows you to adjust the Chiller's external temperature reading to match that of a traceable standard. It allows you to offset the displayed temperature value by as much as $\pm 2.9^{\circ}\text{C}$. It appears only if the external temperature probe is installed.

	NOTE: Calibration offset values are always set and displayed in $^{\circ}\text{C}$.
---	---

1. Press and hold the Units/Menu Button until HL appears on the display.
2. Press and release the Units/Menu Button until °C1 appears on the display.
3. Press and hold the Units/Menu Button.
4. While holding the Units/Menu Button, press and release the Select/Set Knob.
5. When CL2 appears on the Temperature Readout, release the Units/Menu Button. The current calibration offset value will appear on the Temperature Readout and alternate with the fluid temperature reading (enabling you to simultaneously adjust the offset and see the effect on the temperature).

- Rotate the Select/Set Knob until the desired calibration offset is displayed. Press the Select/Set Knob or simply allow the display to time out to accept the displayed value.

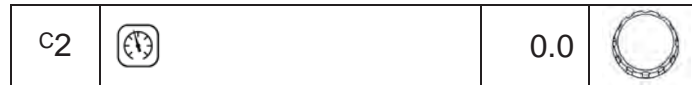

Flow Rate Calibration (Fc)



NOTE: Your Chiller's flow rate is calibrated at the factory at the nominal flow rate for the installed pump. Further adjustment is not necessary.

This menu item allows you to adjust the flow rate display to match that of a known standard.

- Press and hold the Units/Menu Button until HL appears on the display.
- Press and release the Units/Menu Button until the second FL appears (LPM LED will be lit – Fc will be the next parameter).
- Press and hold the Units/Menu Button.
- While holding the Units/Menu Button, press and release the Select/Set Knob.
- When CAL appears on the Temperature Readout, release the Units/Menu Button.
- Rotate the Select/Set Knob until the desired offset is displayed. Press the Select/Set Knob or simply allow the display to time out to accept the displayed value.

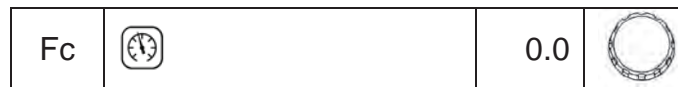

Fuse Bits (Fb)

This menu item allows you to select the logic settings for remote control and the water level float switch. To set fuse bits, proceed as follows:

- Turn electrical power OFF at the rear of the unit.
- Press and hold the Select/Set Knob and Power Button simultaneously.
- While holding the Select/Set Knob and Power Button, turn electrical power ON at the rear of the unit.
- Fb will appear on the Pressure/Flow Rate Display; h followed by two digits will appear on the Temperature Display.
- Rotate the Select/Set Knob to the desired setting (h00, h01, h02, h04, h05, or h06).
- Press and release the Select/Set Knob or simply allow the display to time out to accept the displayed setting.



Troubleshooting

	<p>Many problems can be resolved by restoring the factory defaults. If this solves the problem, be careful when restoring your operational settings in order not to repeat the problem.</p> <p>To restore the factory default settings:</p> <ol style="list-style-type: none"> 1. Place the Power Switch / Circuit Breaker on the rear of the unit in the OFF position. 2. Press and hold the Power Button on the front panel while returning the Power Switch / Circuit Breaker to the ON position.
---	--

	<p>WARNING: Service should only be performed by fully qualified personnel. Extreme caution is required as hazards are present when servicing this equipment.</p>
---	---

Problem	Possible Causes	Corrective Action
Unit does not run (digital displays blank)	No power to unit	Check that the electrical cord or wiring is secure and connected to an operating electrical source. Check that Power Switch / Circuit Breaker on rear of unit is ON.
Unit does not run (three decimal points appear on Temperature Display, two decimal points on Pressure/Flow Rate Display)	Unit in Standby mode	Press Power Button on front panel.
No fluid circulation	Insufficient fluid in reservoir Blockage in circulating system Pump is not operating	Add fluid to reservoir. Remove blockage. Replace pump.
Insufficient circulation	Fluid viscosity too high External tubing diameter too small Restrictions in fluid lines Low line voltage	Replace with lower viscosity fluid. Replace with larger diameter tubing. Check and correct as required. Check and correct as required.
Unit does not cool or cooling is insufficient	Dust build up on air filter or condenser Blocked air ventilation screens Excessive heat load Ambient air temperature too high Low or high line voltage Faulty temperature sensor	Clean air filter and/or condenser as required. Remove blockages as required. Check that heat load does not exceed capacity of Chiller; correct as required. Decrease ambient air temperature. Check and correct as required. Check the compressor upper, evaporator inlet and evaporator outlet temperature sensor readings (see "Diagnostic Mode"). If any of these temperature readings is -50°C, the sensor needs to be replaced.
Unit does not heat	OTP has tripped due to Insufficient fluid in reservoir	Add fluid to reservoir and reset OTP.
Fault code 10 on display	Extreme electrical line interference Triac failure	Plug unit into another power source. If problem persists, triac has failed. Replace triac or triac driver as required.

Problem	Possible Causes	Corrective Action
Fault code 11 on display	Internal probe failure	Contact service representative.
Fault code 12 on display	Loose external probe connection Faulty external temperature probe	Check and correct as required. Replace as required. NOTE: Chiller may be operated using internal probe until problem is corrected.

Diagnostic Mode

	NOTE: The Chiller must be set to display temperature in °C in order to access the diagnostic mode.
---	---

The Chiller incorporates a Diagnostic mode, which displays important operational information that can aid in troubleshooting. To access the Diagnostic mode, place the Circuit Breaker/Power Switch in the OFF position and then return it to the ON position while pressing and holding the Select/Set Knob. The diagnostic menu appears on the Pressure/Flow Rate Display; the current value for the diagnostic item appears on the Temperature Readout.

	NOTE: Diagnostic items are display values only; they cannot be changed.
---	--

Menu Item	Description
At	Ambient temperature at front panel
EC	External control
Li	Percent of Line voltage
Ct	Chiller type (model)
Fb	Fuse bits (remote control voltage, contact closures, etc.)
EP	External probe temperature and “---”, displayed when external probe is not installed
03 (variable numeric value)	Fluid flow rate or pressure; Temperature Display shows current fluid temperature

Technical Information

Controller Specifications

Temperature Set Point Resolution	±0.1°C
Temperature Stability	±0.5°C (±0.9°F)
Temperature Units	°C or °F
Pressure Units	PSI or kPa
Pressure Display Resolution	1 PSI / 0.1 kPa
Flow Rate Units	GPM or LPM
Flow Rate Display Resolution	0.1 GPM / 1 LPM

Performance Specifications

Model		Air-Cooled 58XX & 68SS Series	Water-Cooled 59XX & 69XX Series
Compressor	Nominal HP	1.5	
Temperature Range (without heater option)	°F °C	41° to 95°F 5° to 35°C	
Temperature Range (with heater option)	°F °C	41° to 194°F 5° to 90°C	
Temperature Stability	°F °C	±0.9°F ±0.5°C	
Cooling Capacity ¹	Tons Watts BTU/hour	1.48 5200 17,732	1.8 6328 21,600
Nominal Evaporator Flow ²	US GPM	3.72	4.3
Refrigerant		R134A	
Pressure ³	PSIG	60	
Pump ³	HP	1/3	
Fan(s)	HP	1/6	N/A
Condenser Discharge Air Flow	CFM	1070	N/A
Water Condenser Flow – Tower Water	US GPM	N/A	5.4
Water Condenser Connections	Inches	N/A	0.75
Process Connections (inlet / outlet)	Inches	0.5	
Reservoir Tank Capacity	US Gallons (liters)	3.5 (13.25)	
Dimensions (L x W x H)	Inches cm	30.5 x 19 x 26" 78 x 48 x 66 cm	
Shipping Weight	Pounds kg	340 154	

1. Capacity of air-cooled units based on 68°F (20°C) entering air and 68°F (20°C) leaving water; capacity of water-cooled units based on 85°F (29°C) entering water.

2. Chiller flow rate based on 2.4 US GPM ton (0.54m³/hr/ton).
 Environmental Conditions Indoor use only
 Maximum Altitude: 2000 meters
 Operating Ambient: 5° to 35°C
 Relative Humidity: 80% for temperatures to 30°C
 Installation Category: II
 Pollution Degree: 2

Electrical Specifications

MAXIMUM OPERATING CURRENT CAN BE FOUND ON THE UNITS ELECTRICAL NAMEPLATE ON THE REAR PANEL OF THE CHILLER	"P0" No pump		"P4" "P6" "P9" POSITIVE DISPLACEMENT PUMPS		"M5" "M6" MAGNETIC DRIVE PUMPS*		"T2" "T3" 1/3 HP TURBINE PUMPS		"T5" "T6" "T7" "T8" 3/4 HP TURBINE PUMPS		"T9" "T0" "T1" 1 HP TURBINE PUMPS	
	MAX. OPERATING CURRENT	FUSE / CIRCUIT BREAKER SIZE	MAX. OPERATING CURRENT	FUSE / CIRCUIT BREAKER SIZE	MAX. OPERATING CURRENT	FUSE / CIRCUIT BREAKER SIZE	MAX. OPERATING CURRENT	FUSE / CIRCUIT BREAKER SIZE	MAX. OPERATING CURRENT	FUSE / CIRCUIT BREAKER SIZE	MAX. OPERATING CURRENT	FUSE / CIRCUIT BREAKER SIZE
AIR-COOLED WITH HEATERS												
585x3 - 240V / 1PH / 50HZ / 3KW HEATER	26.3	40	29.5	40	27	40	30.2	40	33.9	45	NA	
585x9 - 240V / 1PH / 50HZ / 9KW HEATER	51.3	65	54.3	70	52	65	55.2	70	58.9	70	NA	
586x3 - 208-230V / 1PH / 60HZ / 3KW HEATER	26.6	40	29.4	40	27.3	40	29.5	40	31.4	40	35.1	50
586x9 - 208-230V / 1PH / 60HZ / 9KW HEATER	51.6	65	54.4	70	52.3	70	54.5	70	58.4	70	60.1	70
587x3 - 208-230V / 3PH / 50-60HZ / 3KW HEATER	16.7	25	19.9	30	17.4	25	18.5	25	19.26	25	20.7	30
587x7 - 208-230V / 3PH / 50-60HZ / 7.5KW HEATER	27.5	35	30.7	40	28.2	35	29.3	40	30.06	40	31.5	40
587x9 - 208-230V / 3PH / 50-60HZ / 9KW HEATER	31.2	40	34.4	45	31.9	40	33	45	33.76	45	35.2	45
588x3 - 460V / 3PH / 60HZ / 3KW HEATER	8.85	12	11.05	15	NA		9.75	15	10.13	15	10.45	15
588x9 - 460V / 3PH / 60HZ / 9KW HEATER	16.05	20	18.25	25			16.95	20	17.33	25	17.65	25
589x3 - 380V / 3PH / 50HZ / 3KW HEATER	7.55	13	NA		NA		8.45	12	8.84	15	9.55	15
589x9 - 380V / 3PH / 50HZ / 9KW HEATER	12.05	15					12.95	20	13.34	20	14.05	20
WATER-COOLED WITH HEATERS												
595x3 - 240V / 1PH / 50HZ / 3KW HEATER	25.2	40	28	40	25.9	40	29.1	40	32.8	45	NA	
595x9 - 240V / 1PH / 50HZ / 9KW HEATER	50.2	60	53	65	50.9	65	54.1	65	57.8	70	NA	
596x3 - 208-230V / 1PH / 60HZ / 3KW HEATER	25.5	40	28.3	40	26.2	40	28.4	40	30.3	40	34	45
596x9 - 208-230V / 1PH / 60HZ / 9KW HEATER	50.5	60	53.3	65	51.2	60	53.4	65	55.3	70	59	70
597x3 - 208-230V / 3PH / 50-60HZ / 3KW HEATER	15.6	25	18.4	25	16.3	25	17.4	25	18.16	25	19.6	25
597x7 - 208-230V / 3PH / 50-60HZ / 7.5KW HEATER	26.4	35	29.2	40	27.1	35	28.2	40	29.96	40	30.4	40
597x9 - 208-230V / 3PH / 50-60HZ / 9KW HEATER	30.1	40	32.9	40	30.8	40	31.9	40	32.66	40	34.1	45
598x3 - 460V / 3PH / 60HZ / 3KW HEATER	8.3	12	10.5	15	NA		9.2	15	9.58	15	9.9	15
598x9 - 460V / 3PH / 60HZ / 9KW HEATER	15.5	20	17.7	25			16.4	25	16.78	25	17.1	25
599x3 - 380V / 3PH / 50HZ / 3KW HEATER	7	10	NA		NA		7.9	12	8.29	12	9	15
599x9 - 380V / 3PH / 50HZ / 9KW HEATER	11.5	15					12.4	20	12.79	20	13.5	20
AIR-COOLED												
685x - 240V / 1PH / 50HZ	18	25	20.8	30	18.7	30	21.9	30	25.8	40	NA	
686x - 208-230V / 1PH / 60HZ	18.3	25	21.1	30	18	30	21.2	30	23.1	35	26.8	40
687x - 208-230V / 3PH / 50-60HZ	13.7	20	16.5	25	14.4	25	15.5	25	16.26	25	17.7	25
688x - 460V / 3PH / 60HZ	6.45	10	8.66	12	NA		7.36	12	7.73	12	8.05	12
689x - 380V / 3PH / 50HZ	6.05	10	NA				8.95	12	7.34	12	8.05	12
WATER-COOLED												
695x - 240V / 1PH / 50HZ	16.9	25	19.7	30	17.6	25	20.8	30	24.5	25	NA	
696x - 208-230V / 1PH / 60HZ	17.2	25	20	30	17.9	25	20.1	30	22	30	25.7	35
697x - 208-230V / 3PH / 50-60HZ	12.1	20	14.9	25	12.8	20	13.9	20	14.66	25	16.1	25
698x - 460V / 3PH / 60HZ	5.9	10	8.1	12	NA		6.8	10	7.18	12	7.5	12
699x - 380V / 3PH / 50HZ	5.5	10	NA				8.4	10	6.78	10	7.5	12

Pump for 1-1/2 HP Chillers

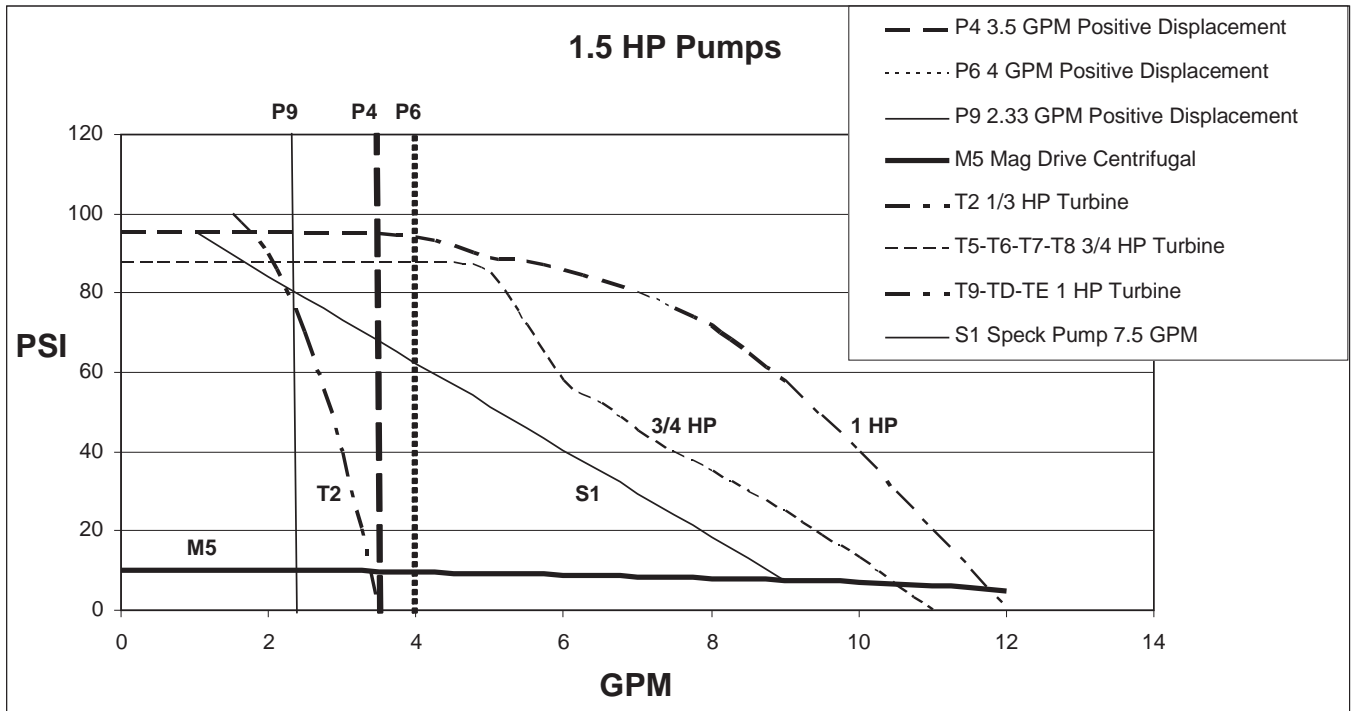

Specifications subject to change without notice.

RS-232 / RS-485 Communications

Serial Connector — A 9-pin D-connector (optional) is provided on the back panel of the Chiller for RS232 / RS485 data communication. A serial cable that uses only the following pins should be used to connect the Chiller to the computer:

RS-232	
Pin # 2	Transmit (Tx)
Pin # 3	Receive (Rx)
Pin # 5	signal ground

RS-485	
Pin # 3	DAT (+) on "B"
Pin # 5	signal ground
Pin # 9	DAT (-) on "A"

RS-232 / RS-485 Protocol — The controller uses the following RS-232 / RS-485 protocol:

- Data bits — 8
- Parity — none
- Stop bits — 1
- Flow control — none
- Baud rate — selectable (Chiller and PC baud rates must match).

Communications Commands — Commands must be entered in the exact format shown. Do not send a [LF] (line feed) after the [CR] (carriage return). Be sure to follow character case exactly. A question mark (?) indicates that the Chiller could not execute the command (either because it was in an improper format or the values were outside the allowable range). A response followed by an exclamation point (!) indicates that a command was executed correctly. A response must be received from the Chiller before another command can be sent. All responses are terminated with a single [CR].

Command Description	Command Format	Values	Return Message
Set command echo	SEi[CR]	Echo: i = 1 No Echo: i = 0	![CR]
Set On / Off	SOi[CR]	On: i = 1 Off: i = 0	![CR]
Set set point	SSxxx[CR]	x = ASCII digit	![CR]
Read set point temperature	RS[CR]		![CR]
Read temperature	RT[CR]		![CR]
Read temperature units	RU[CR]	C or F	C[CR] or F[CR]
Read status	RW[CR]	1 = Run 0 = Standby	1[CR] or 0[CR]
Read pressure in PSI	RP[CR]		![CR]
Read pressure in kPa	RK[CR]		![CR]
Read flow in GPM	RG[CR]		![CR]
Read flow in LPM	RL[CR]		![CR]
Read remote control voltage	RC[CR]		![CR]
Read remote temperature probe	RR[CR]		![CR]
Read ambient temperature on PCB	RA[CR]		![CR]
Read fault status	RF[CR]		![CR]
Read line voltage	RV[CR]		![CR]
Read internal temperature	R1[CR]		![CR]
Read external temperature	R2[CR]		![CR]

Certificate of Compliance

All Chillers are tested after assembly to ensure that the product meets or exceeds published mechanical and safety specifications as well as your satisfaction. The Certificate of Compliance is included with the Chiller. The following graph explains the steps involved in a typical test.

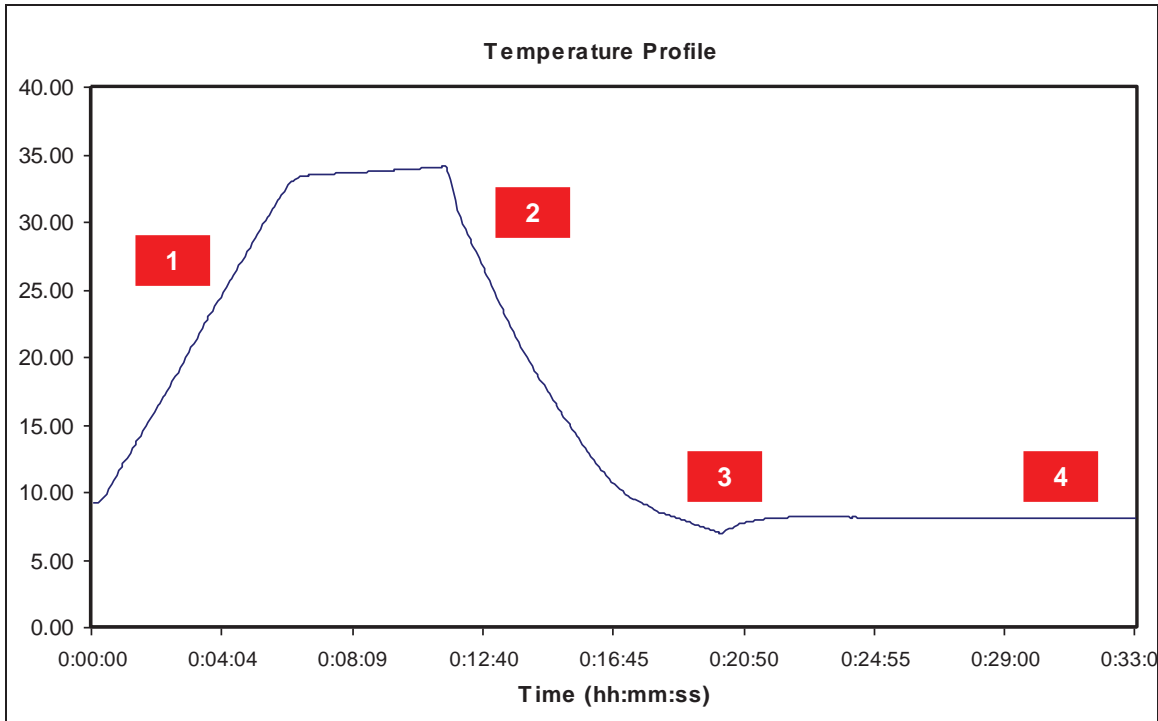

1. Raise fluid temperature.
2. Measure cooling performance.
3. Apply heat load to Chiller to simulate real application conditions. The heat load applied is based on the Chiller's cooling capacity.
4. Measure temperature stability.

Equipment Disposal (WEEE Directive)

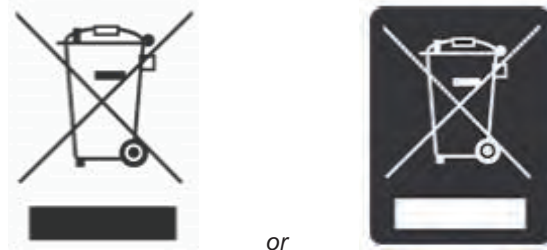

This equipment is marked with the crossed out wheeled bin symbol to indicate it is covered by the Waste Electrical and Electronic Equipment (WEEE) Directive and is not to be disposed of as unsorted municipal waste. **Any products marked with this symbol must be collected separately, according to the regulatory guidelines in your area.**

Service and Technical Support

If your unit fails to operate properly, contact the supplier from whom the unit was purchased. Have the model, serial number, and voltage information from the back panel label along with a summary of the problem available.

Replacement Parts

Description	Part Number
Controller PCB NOTE: When replacing the Controller PCB, it is important to note the software version. You can obtain the software version by pressing and holding the Power Button on the controller while the unit is in "Standby". For our standard software the left display will read "T3" and the right display will read "003" or software version T3-003. If you are unable to obtain the software version, your model number and serial number will be required.	Varies with software options
RTD Temperature Sensor	200-430-KIT
Remote / Ambient Tracking Probe, 10' cable, DB9 Female Plug	060101
Remote / Ambient Tracking Probe, 25' cable, DB9 Female Plug	060105
Remote / Ambient Tracking Probe, 50' cable, DB9 Female Plug	060110
Fluid Pressure Sensor, Standard	750-381-KIT
Fluid Pressure Sensor, SS, DI units	750-384-KIT
VLV, BR, BYP, ½, 45-100#, Insulated	750-175-KIT
KIT Rotor, 6 Pole Flow Indicator	330-571-KIT
Switch, Circuit Breaker, 30 Amp, 1PH	215-818
Flow Sensor, Hall Effect, Honeywell	330-087
Float Switch, Water Level, Single Float @ 7.0"	235-061
Float Switch, Water Level, Dual Float, @ 6.8/8.0"	235-064
Float Switch, Water level, Dual Float, @ 4.6/9.3" (NC contacts)	235-055
Compressor, 1.5HP, COP #CS18K6E-PFV-255	750-876
Compressor, 2.0HP, COP #CS18K6E-PFJ-255	750-877
Compressor, 2.0HP, COP#CS18K6E-TFD-255	750-878
Compressor, 1.5HP, COP #CS18K6E-TF5-255	750-883
Motor, Fan, 230V, Emerson # 050-0265-00	215-519
Motor, Fan, 380-460V, Emerson # 950-0265-01	215-629
Heater Cartridge, 240V, 1000W (6xxx units)	215-459
Heater Cartridge, 240V, 1000W (5xxx units)	215-903
Heater Cartridge, 240V, 2500W	215-564
Heater Cartridge, 480V, 1000W	215-654
Heater Cartridge, 480V, 3000W	215-644
Solid State Relay, 50 Amp, Crydom HA6050-10 (for Heaters)	200-343
Solid State Relay, 25 Amp, 48-600V, 3-32CV (Compressor)	200-580
Contactor, ABB A9-30-10-36	215-468
Contactor, ABB A26-30-10-36	215-674
Contactor, ABB DP60C2P-2	215-802
Capacitor, Start, Compressor, 145-174MFD, 250V, COP#914-000-607	750-336

Description	Part Number
Capacitor, Run, Compressor, 35MFD,370V, COP#914-0037-11 (60HZ)	750-337
Capacitor, Run, Compressor, 45MFD,370V, COP#914-0037-18 (50HZ)	750-414
Relay, Compressor, COP#040-0166-15, COP#040-0166-15	750-338
PCB, 4-20mA Set Point Control	500-342
High Pressure Control, Penn#P100CC-9C, 275/175	215-473
Compressor Pressure Regulator Valve, SP#CRO-T-6-30/110-5/8ODF	750-766
Valve, Solenoid, Refrigeration, Liquid and Hot Gas Bypass, PK#DS1100,240VAC	750-179
Filter Dryer, SP#C-053-S, 3/8ODF	750-075
Air Filter, Condenser	750-387
ORLY,ABB, TF42-1.3, 1.0-1.3A	200-566
ORLY,ABB, TF42-1.7, 1.3-1.7A	200-567
ORLY,ABB, TF42-2.3, 1.7-2.3A	200-568
ORLY,ABB, TF42-3.1, 2.3-3.1A	200-569
ORLY,ABB, TF42-4.2, 3.1-4.2A	200-570
ORLY,ABB, TF42-5.7, 4.2-5.7A	200-571
ORLY,ABB, TF42-7.6, 5.7-7.6A	200-572
ORLY,ABB, TF42-10, 7.6-10.0A	200-573
ORLY,ABB, TF42-1.0, 0.74-1.0	200-574
CNTOR,ABB,AF09-30-10-13	215-905
CNTOR,ABB,AF12-30-10-13	215-906
CNTOR,ABB,AF16-30-10-13	215-907
CNTOR,ABB,AF26-30-00-13	215-908
CNTOR,ABB,AF40-30-00-13	215-909
CNTOR,ABB,AF09Z-30-10-21	215-914
CNTOR,ABB,AF16Z-30-10-21	215-921
RELAY, 50A/600V CRYDOM HA6050-10	200-343
PHASE MONITOR,208-480V,50-60HZ	215-851
CNTOR,ABB,AF09Z-30-10-21	215-914
SUPPRESSOR,TRANSIENT, RK#RCS3G-6V	215-919
SUPPRESSOR,TRANSIENT, RK#RCS2G-6	215-653
PCB ASM, 1.5HP, 230V, BLUE LIGHT, HEAVY	500-451-D
ORLY,ABB, TF42-1.3, 1.0-1.3A	200-566
ORLY,ABB, TF42-1.7, 1.3-1.7A	200-567
ORLY,ABB, TF42-2.3, 1.7-2.3A	200-568
Operator's Manual (on CD 110-925)	110-392

Pumps

Description	Part Number
P4 – Positive Displacement, Rotary Vane, Bronze, 3.5 GPM, 240V/1PH/50-60HZ	Pump – 215-106 Motor – 215-217
P6 – Positive Displacement, Rotary Vane, Stainless Steel 4 GPM, 240V/1PH/50-60HZ	Pump – 215-280 Motor – 215-217
P9 – Positive Displacement, Rotary Vane, Bronze, 2.33 GPM,240V/1PH/50-60HZ	Pump – 215-218 Motor – 215-217
M5 – Mag-Drive Centrifugal Pump, 240V/1PH/50-60HZ (6xxx)	525-552
M6 – Mag-Drive Centrifugal Pump, 240V/1PH/50-60Hz (5xxx)	525-332
S1 – Speck Centrifugal, Stainless Steel, 7.5 GPM, 240V/1PH/50-60HZ	215-306
S3 – Speck Centrifugal, Stainless Steel, 7.5 GPM, 240V/480V/3PH/50-60Hz	215-884
T2 – 1/3HP Turbine, Bronze 3.5 GPM, 240V/1PH/50-60HZ	215-305
T5 – 3/4HP Turbine, Bronze, 240V/1PH/50-60HZ	215-499
T6 – 3/4HP Turbine, Stainless Steel, 240V/1PH/50-60HZ	215-474
T7 – 3/4HP Turbine, Stainless Steel, 208-230V/3PH/50-60HZ	215-475
T8 – 3/4HP Turbine, Bronze, 208-230V/3PH/50-60HZ	215-487
T9 – 1HP Turbine, Stainless Steel, 208-230V/3PH/50-60HZ	215-568
TD – 1HP Turbine, Bronze, 208-230V/3PH/50-60HZ	215-651
TE – 1HP Turbine, Bronze, 240V/1PH/50-60HZ	215-655
TF – 1HP Turbine, Bronze, 380/3/60Hz	215-873
TH – 2HP Turbine, Bronze, 208/230/1/60Hz	215-336

Pump assemblies include motor unless listed separately.

Warranty



NOTE: The warranty applies only to the original end user and cannot be transferred or sold to another end user without written consent from the manufacturer.

The manufacturer's warranty is one year for parts and labor and two years for parts. Please contact your supplier for additional warranty details and service contract information.

The manufacturer agrees to correct for the original user of this product, either by repair, or at the manufacturer's election, by replacement, any defect that develops after delivery of this product for the warranty period(s) stated above. In the event of replacement, the replacement unit will be warranted for 90 days or warranted for the remainder of the original unit's parts or labor warranty period, whichever is longer. If a replacement unit is sent, the defective unit must be returned to the manufacturer within 30 days of receipt of the replacement unit. If the defective unit is not received within 30 days, the manufacturer reserves the right to bill for the replacement unit.

If this product requires service, contact the manufacturer/supplier's office for instructions. If return of the product is necessary, a return authorization number will be assigned and the product should be shipped, (transportation charges pre-paid), to the indicated service center. To insure prompt handling, the return authorization number should be placed on the outside of the package and a detailed explanation of the defect enclosed with the item.

This warranty shall not apply if the defect or malfunction was caused by accident, neglect, unreasonable use, improper service, or other causes not arising out of defects in material or workmanship. There are no warranties, expressed or implied, including, but not limited to, those of merchantability or fitness for a particular purpose which extends beyond the description and period set forth herein.

The manufacturer's sole obligation under this warranty is limited to the repair or replacement of a defective product and shall not, in any event, be liable for any incidental or consequential damages of any kind resulting from use or possession of this product. Some states do not allow: (A) limitations on how long an implied warranty lasts; or (B) the exclusion or limitation of incidental or consequential damages, so the above limitations or exclusions may not apply to you. This warranty gives you specific legal rights. You may have other rights that vary from state to state.

Appendix

Flow Schematic - All Models

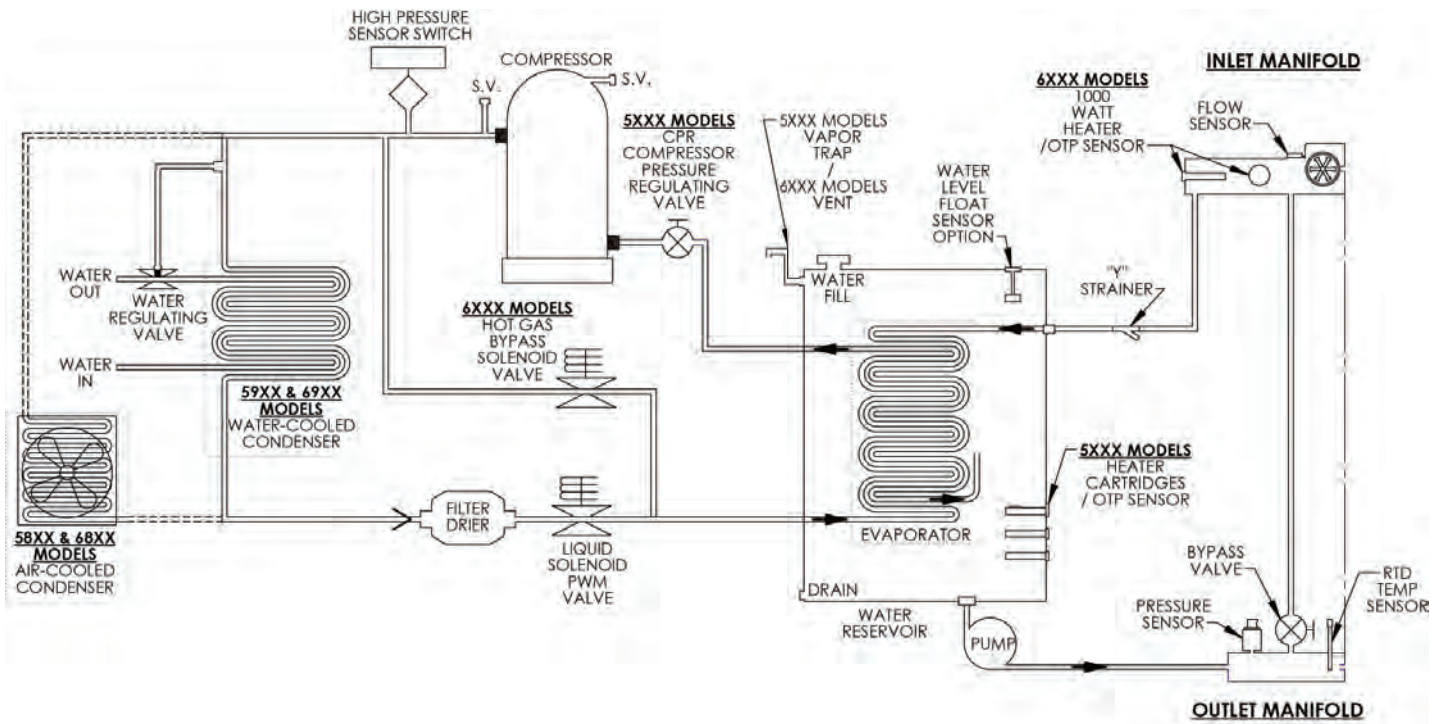

DWG 100-252

Electrical Diagram - 208-230V / 1PH / 50-60Hz Models without heater option

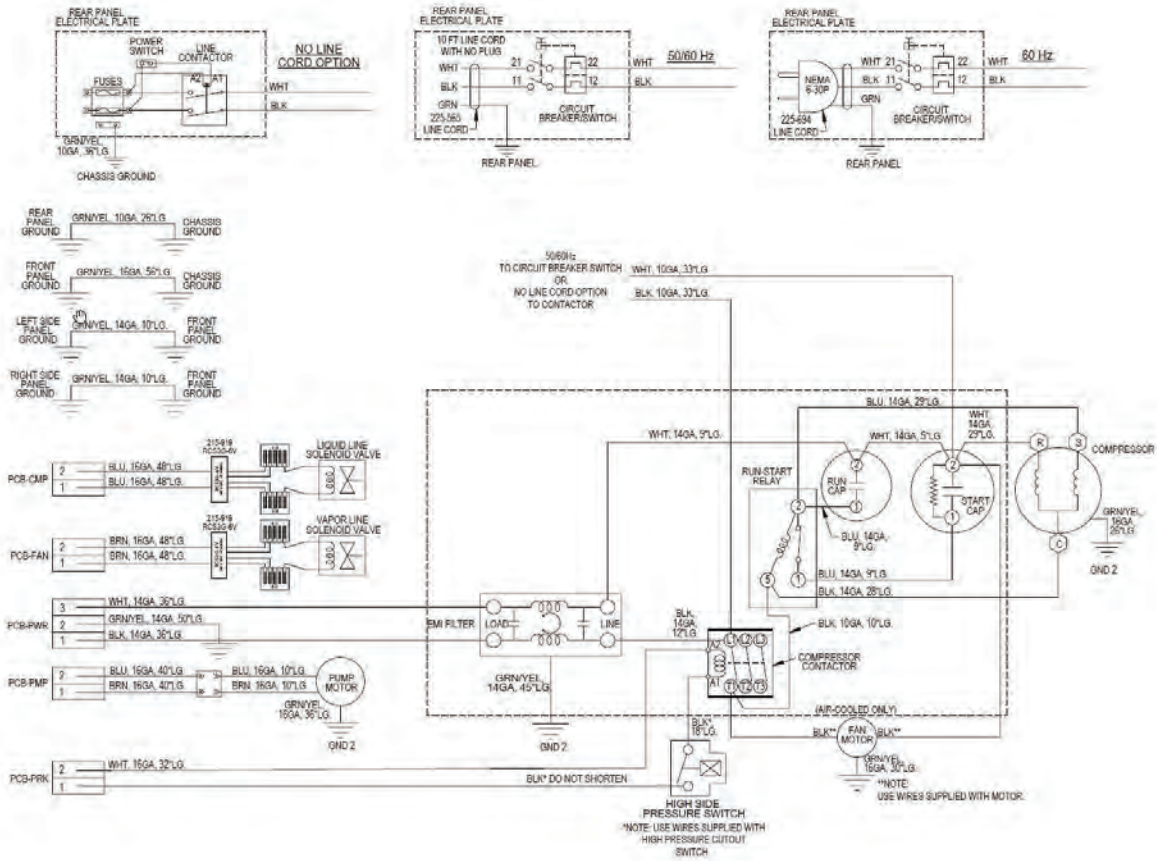

Electrical Diagram - 208-230V / 1PH / 50-60Hz Models with heater option

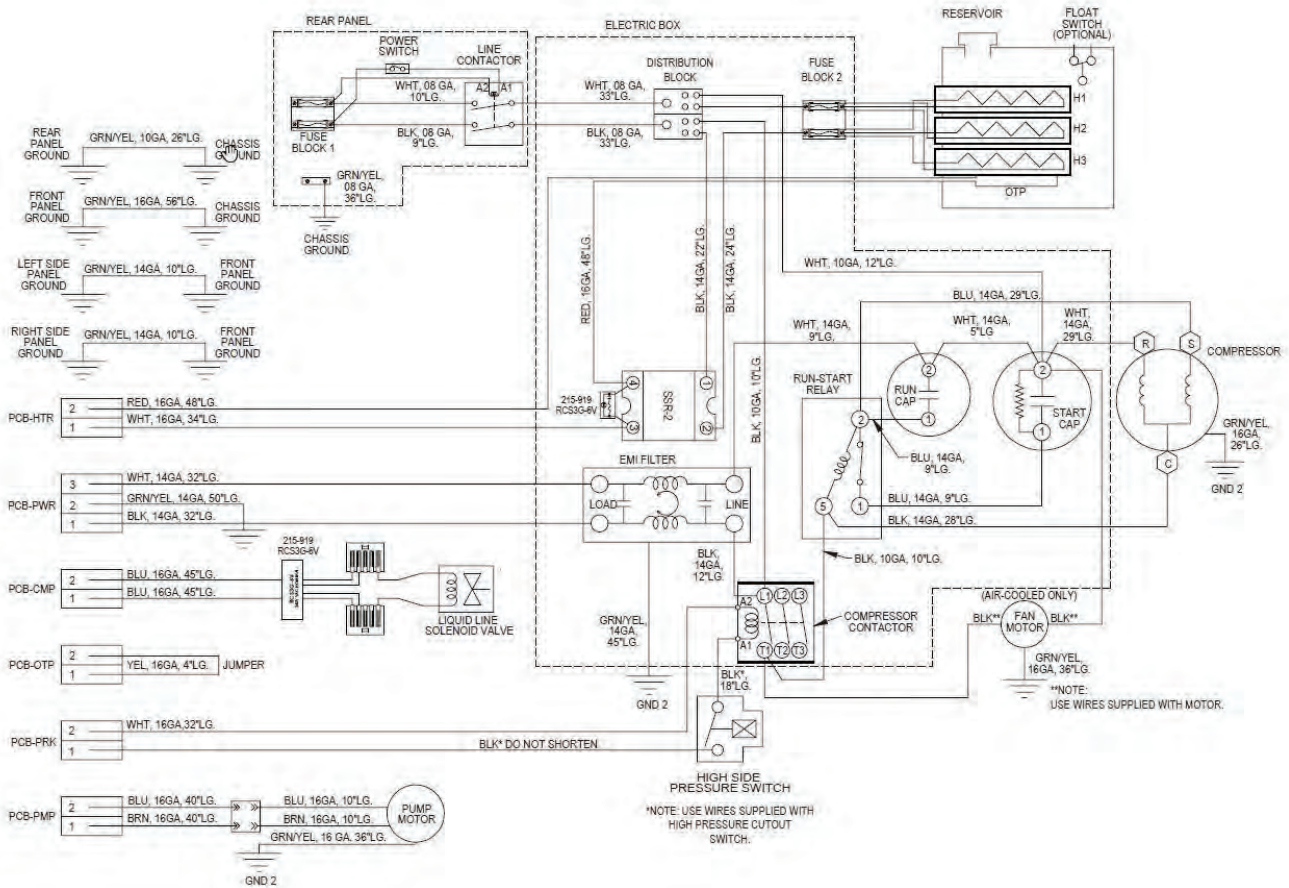

Electrical Diagram – 208-230V / 3PH / 50-60Hz Models without heater option

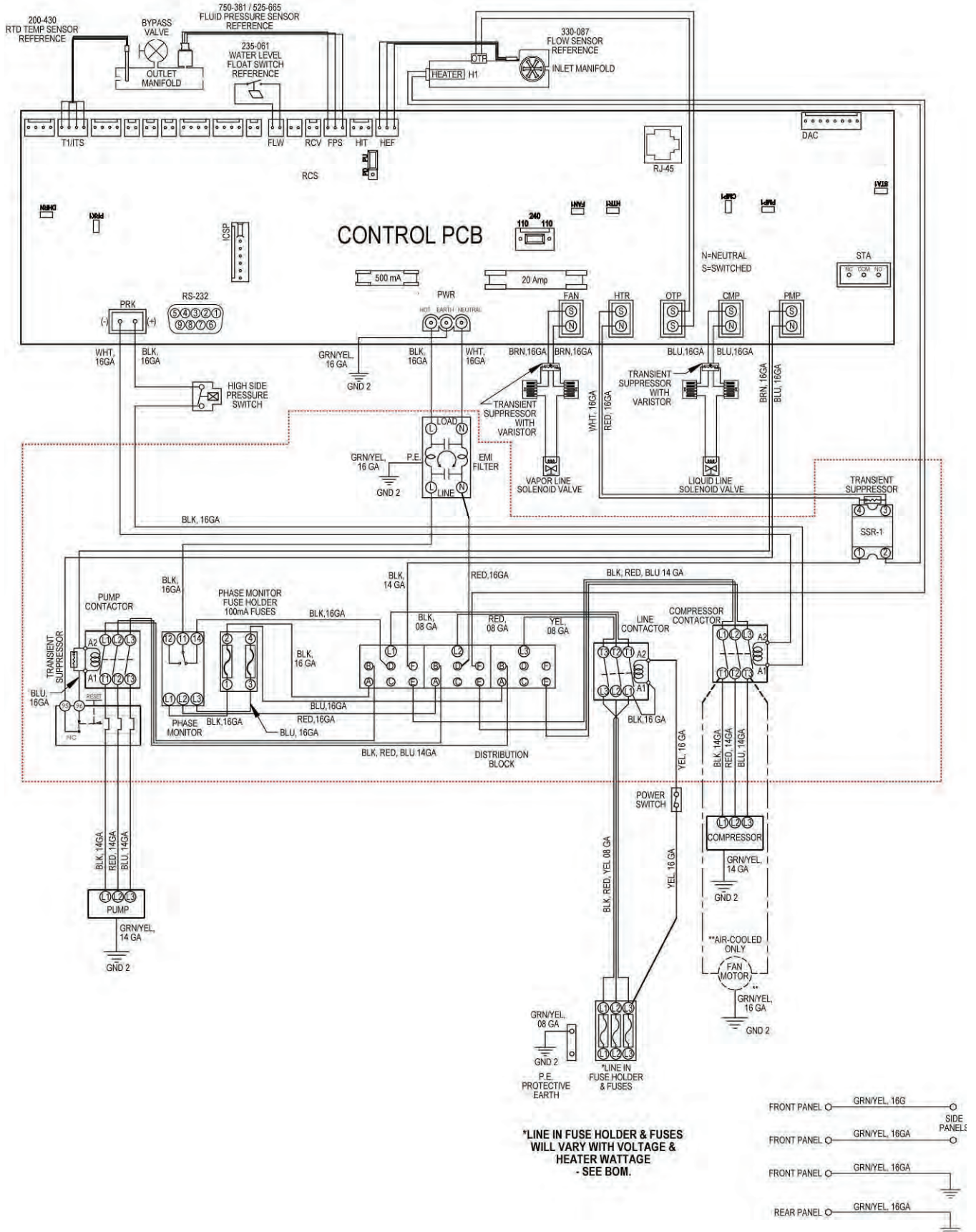

Electrical Diagram – 208-230V / 3PH / 50-60Hz Models with heater option

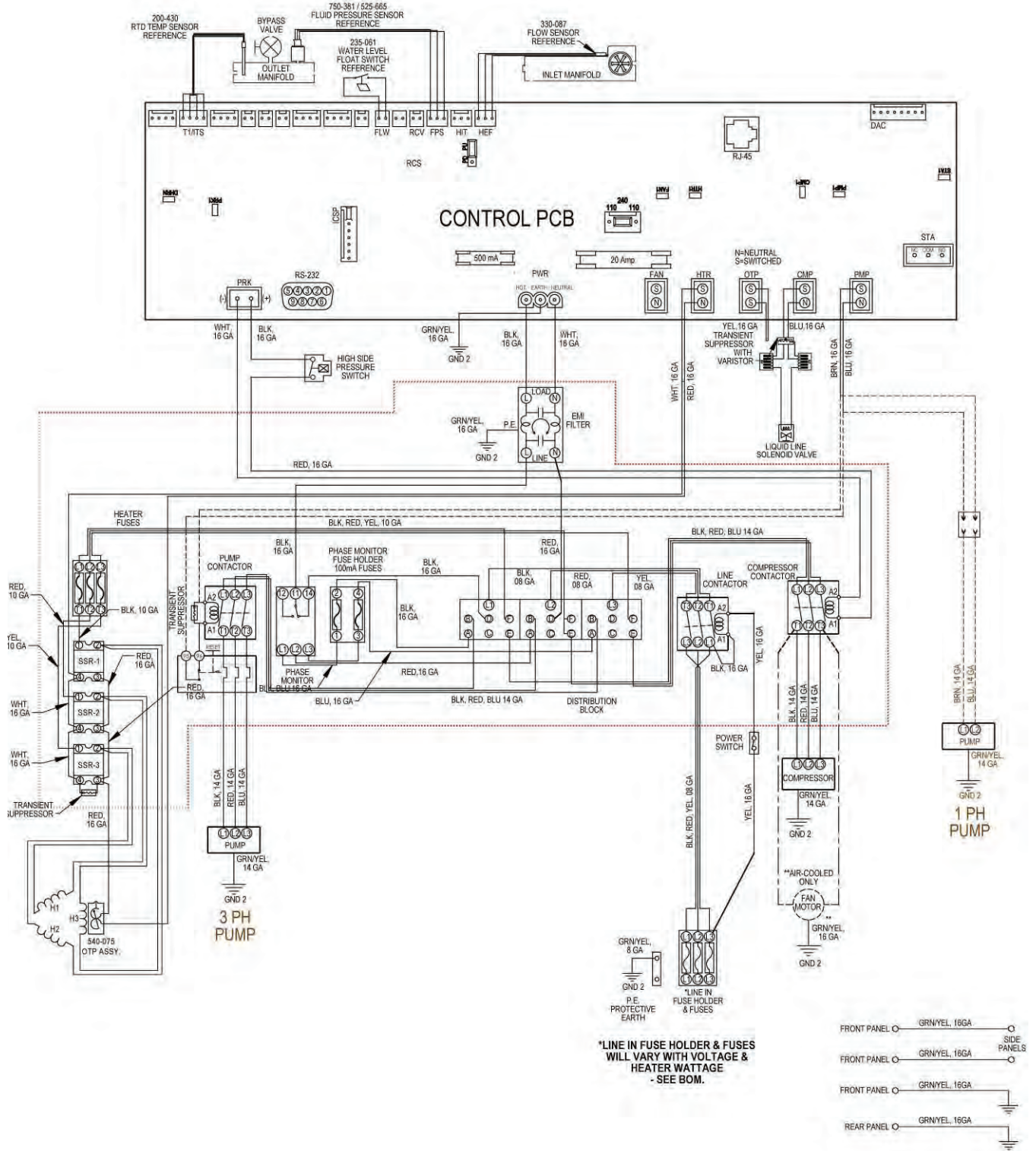

Electrical Diagram – 208-230V / 3PH / 50-60Hz Models with heater option and 4-20ma set point option

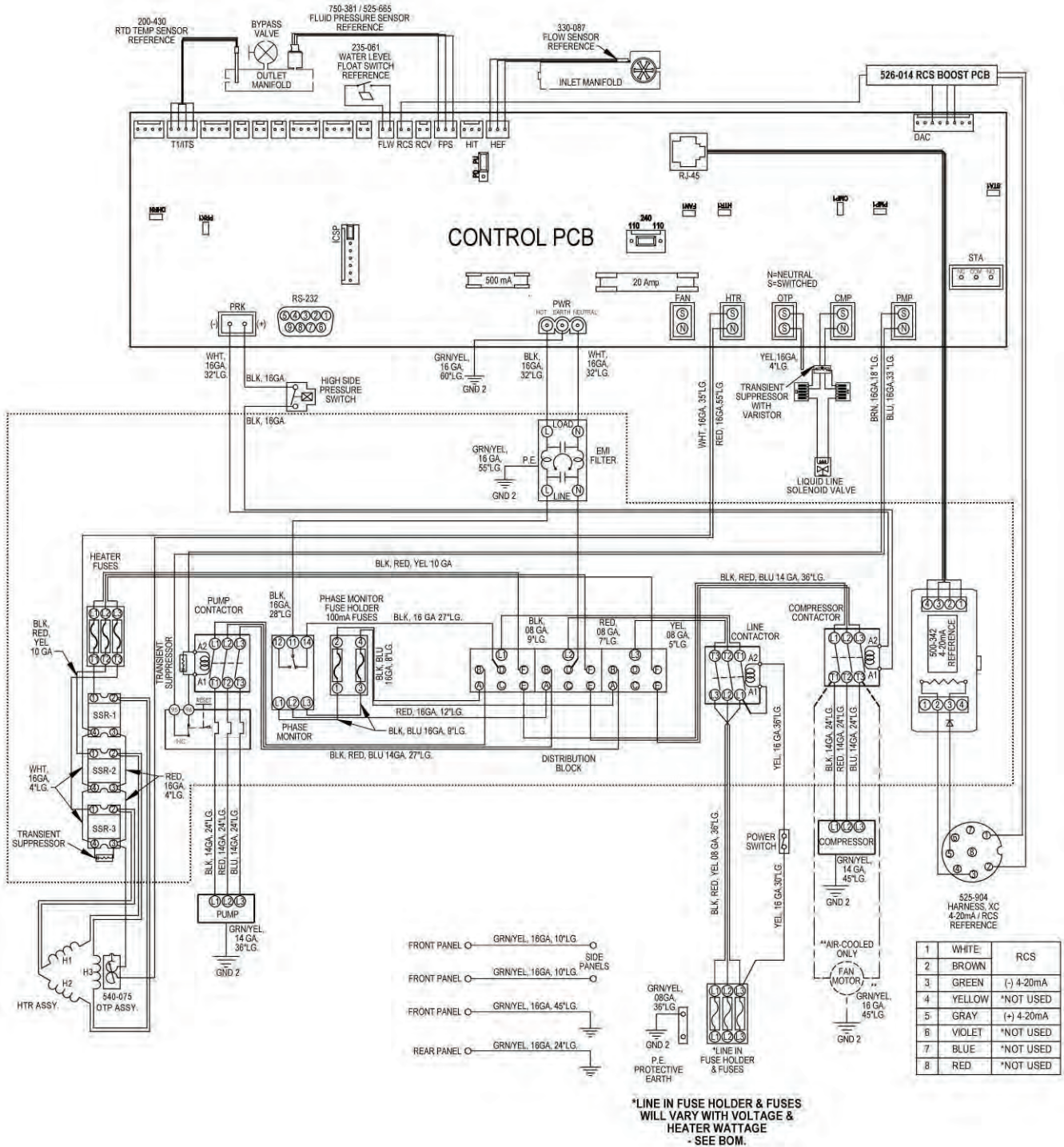

Electrical Diagram – 380V / 3PH / 60Hz Models without heater option

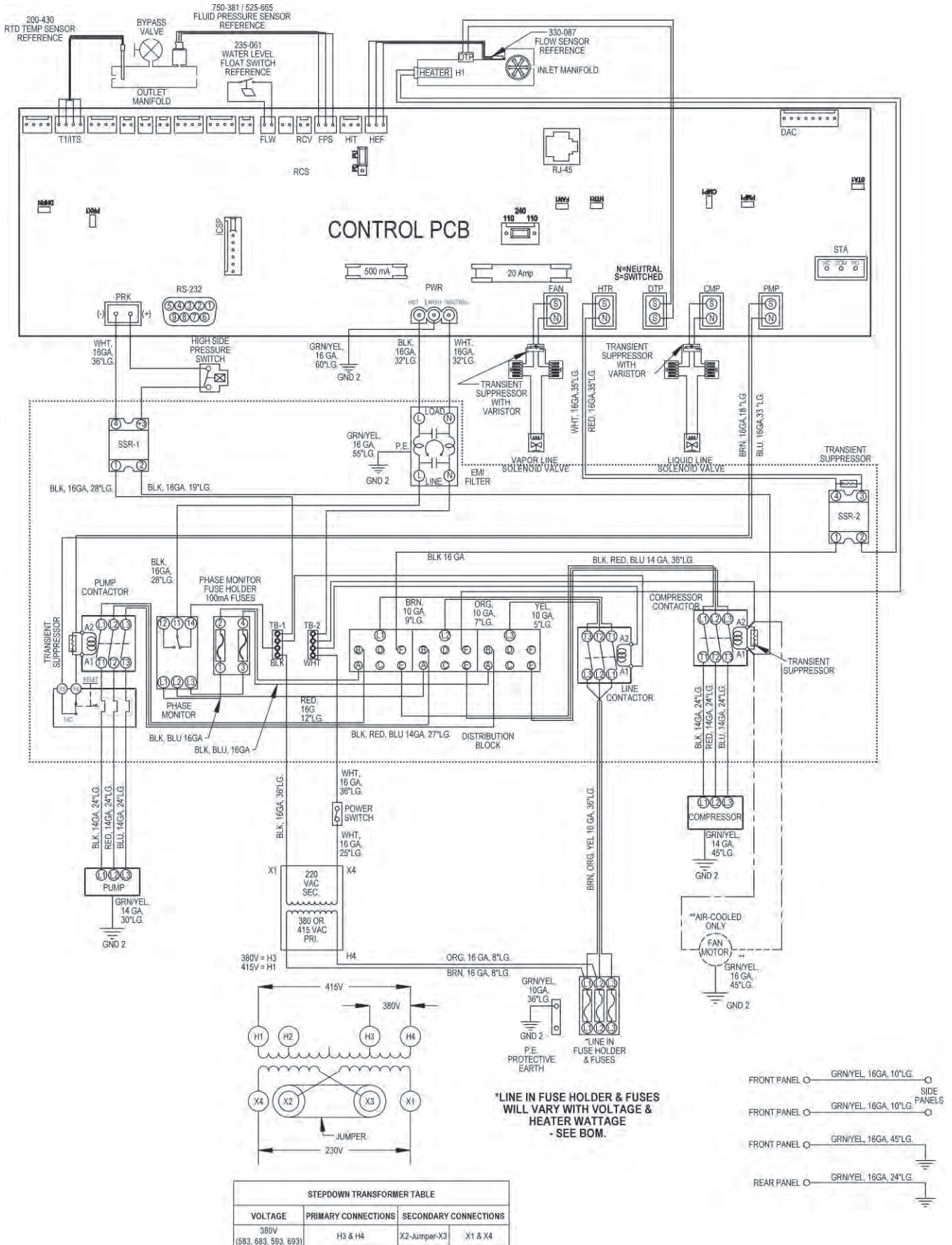

Electrical Diagram – 380V / 3PH / 60Hz Models with heater option and 4-20ma set point option

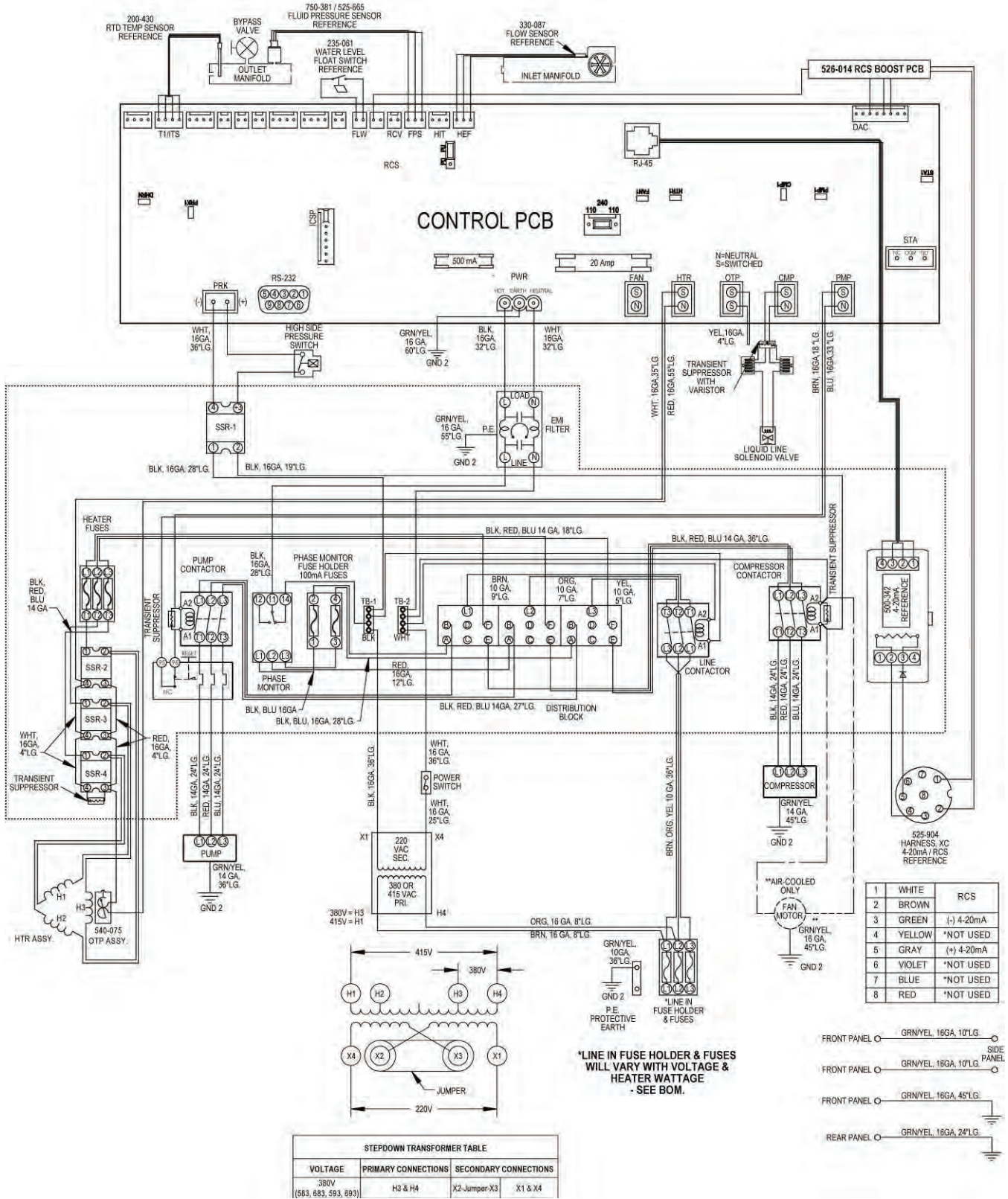

Electrical Diagram – 380-460V / 3PH / 50-60Hz Models without heater option

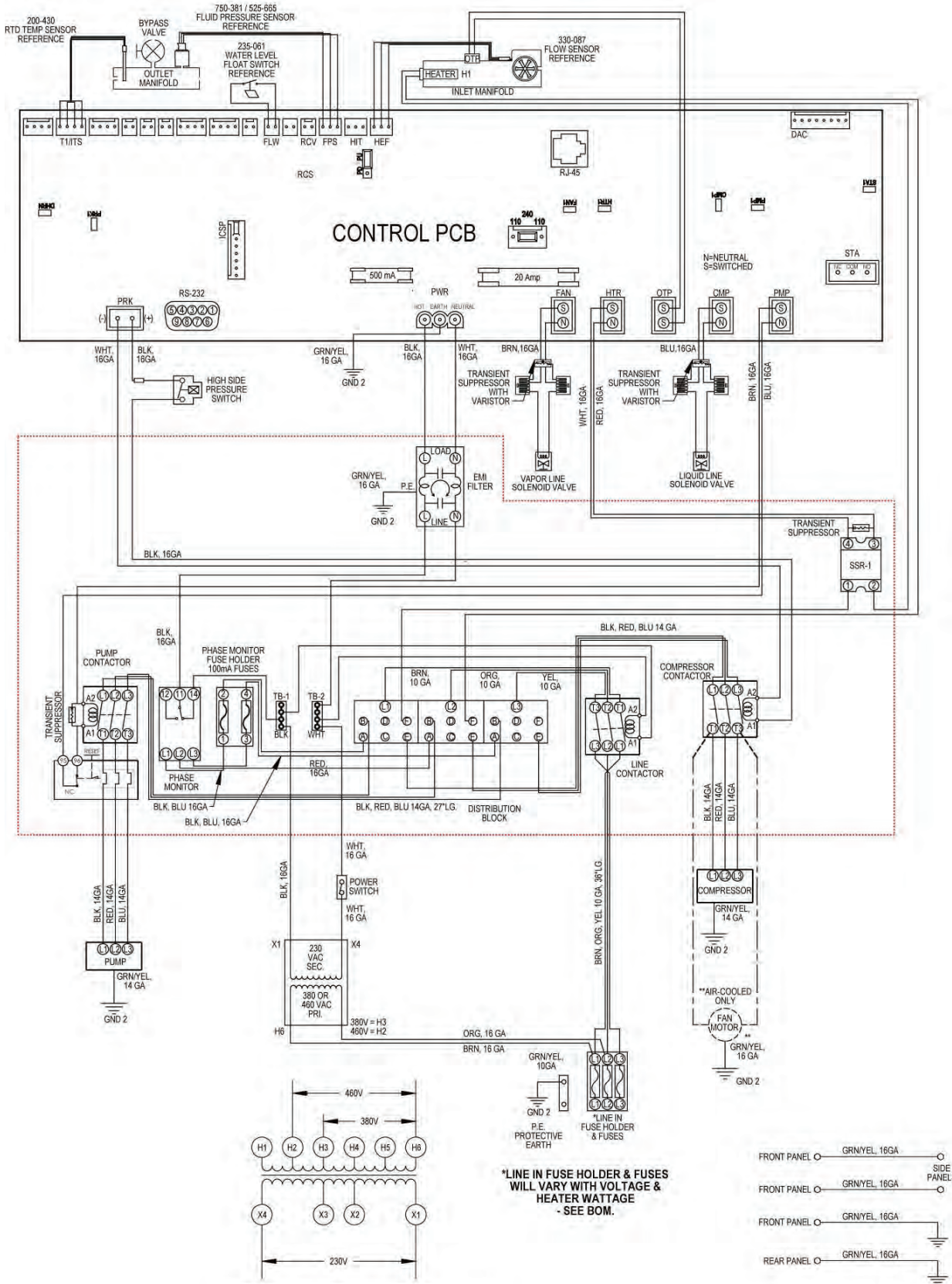

*LINE IN FUSE HOLDER & FUSES WILL VARY WITH VOLTAGE & HEATER WATTAGE - SEE BOM.

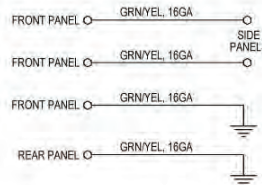

STEPDOWN TRANSFORMER TABLE		
VOLTAGE	PRIMARY CONNECTIONS	SECONDARY CONNECTIONS
380V (883, 689, 693, 699)	H6 & H3	X1 & X4
460V (688, 698)	H6 & H2	

Electrical Diagram – 380-460V / 3PH / 50-60Hz Models with heater option and 4-20ma set point option

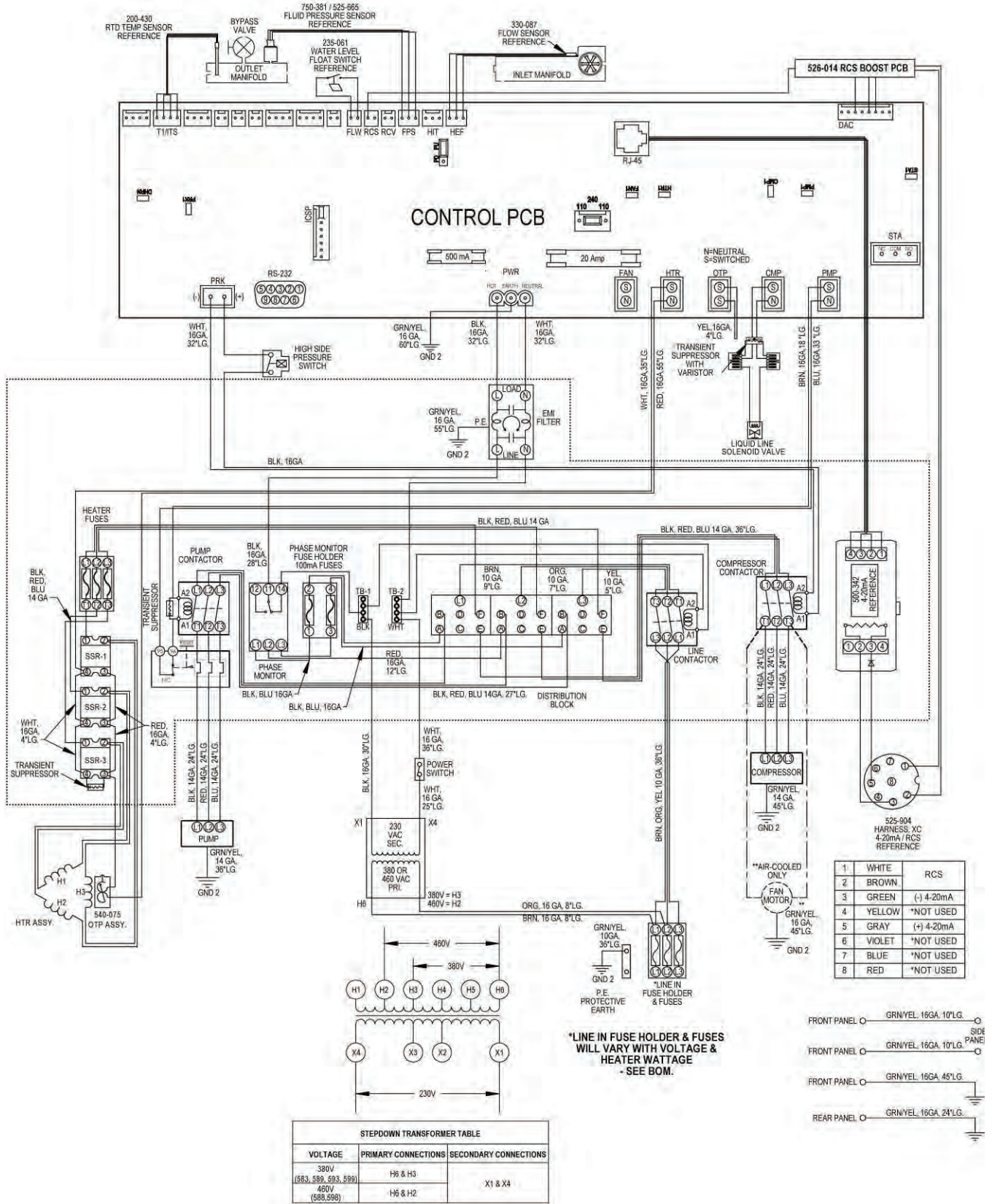

Electrical Diagram – 380-460V / 3PH / 50-60Hz Models with heater option

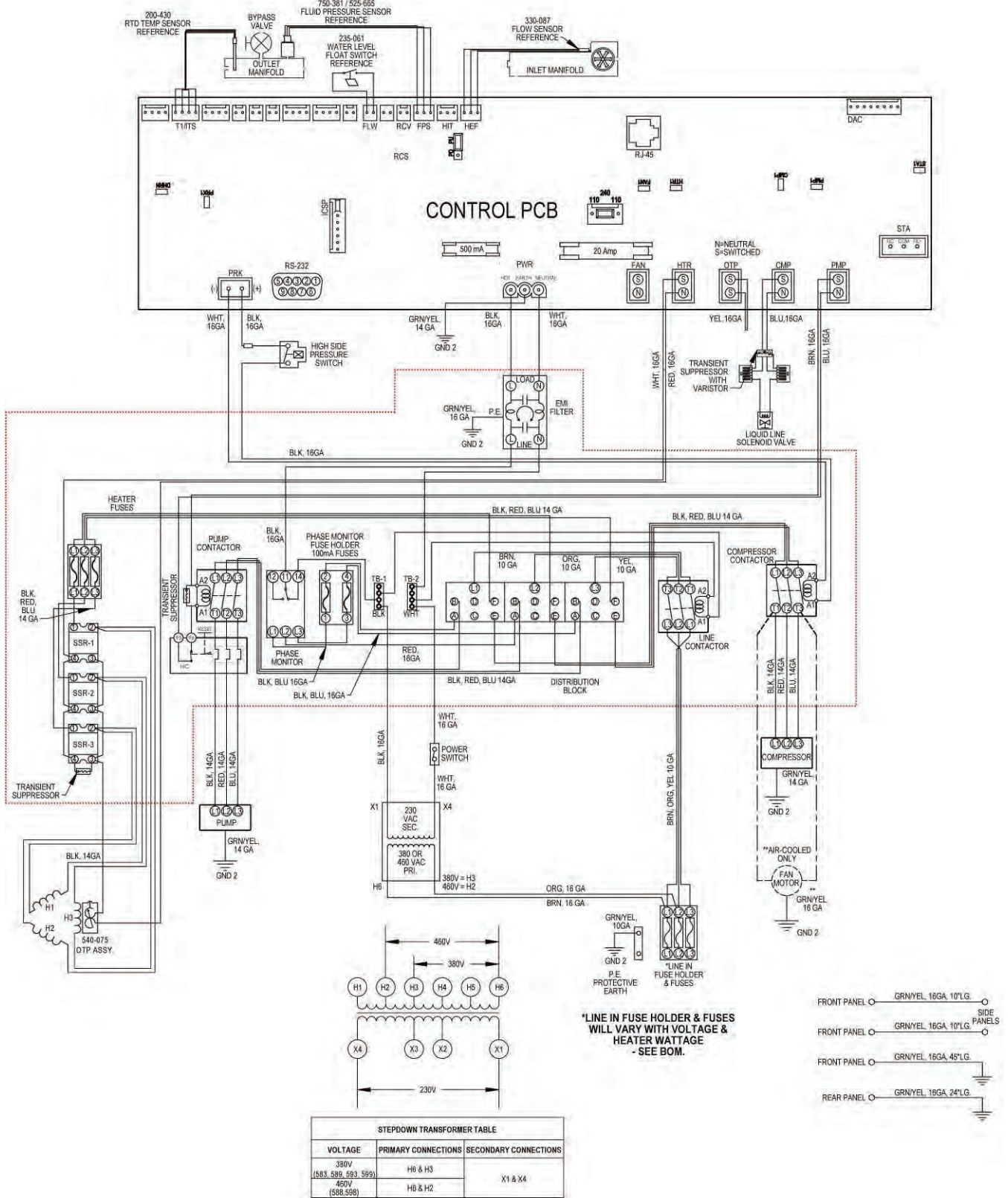

Options

General Options Wiring

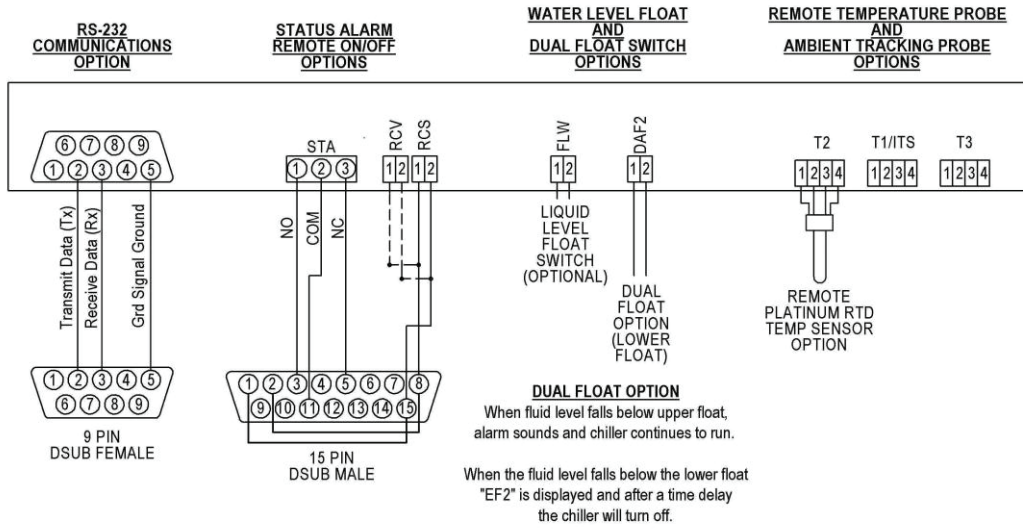

	Pin 3 to Pin 11	Pin 5 to Pin 11
Power Off		X
Standby		X
Alarm		X
Running	X	

Status Alarm (STA): Relay is energized when Chiller is running normally. Relay is de-energized when a fault condition is detected, the unit is placed in Standby, or the unit's power is off.

Remote ON/OFF: RCV = Chiller turns OFF when 12-24V AC or DC signal is applied.
 RCS = Chillers turns OFF when contacts are closed.

RS-485 Communications Wiring

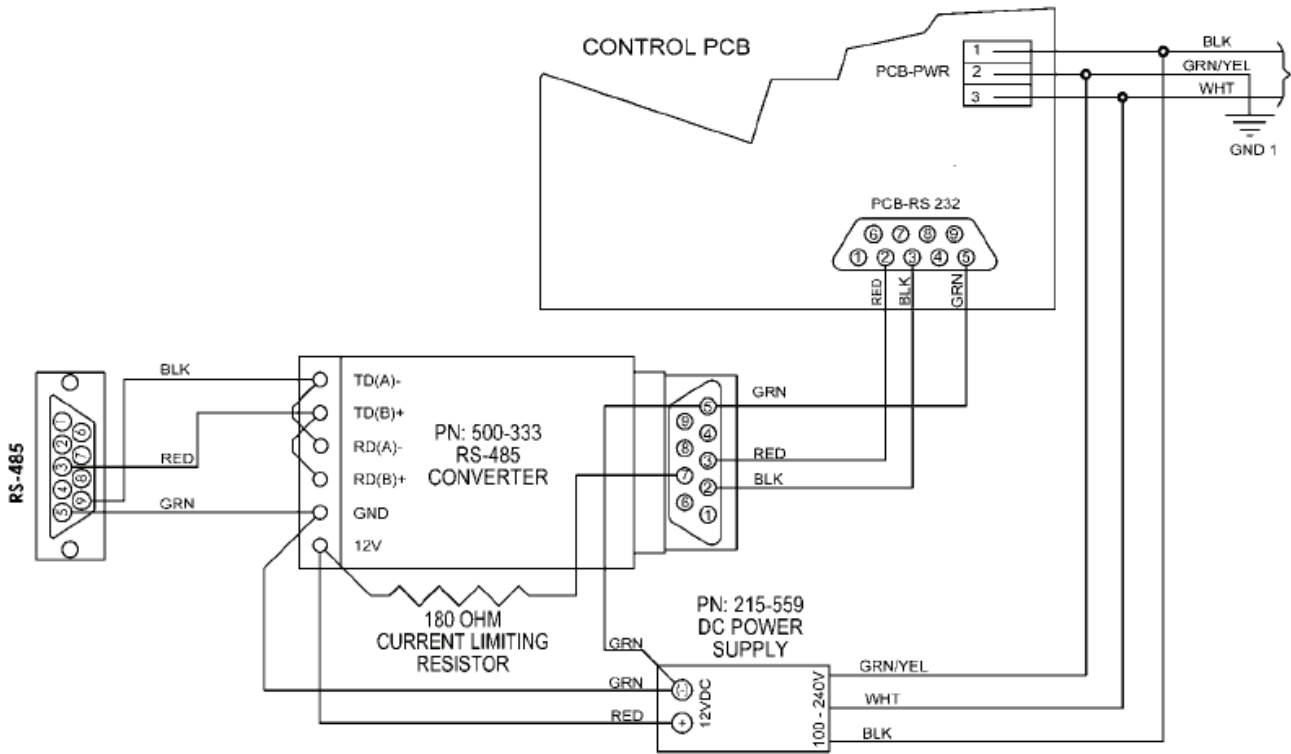

DI Control Wiring

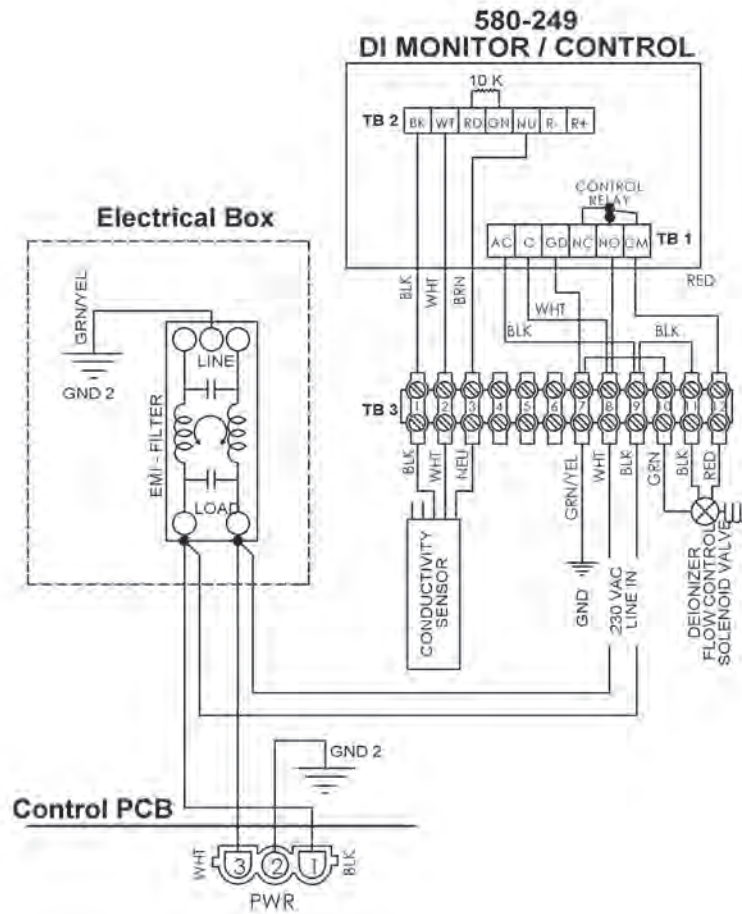

H2 & H3 Option Wiring

H2 = 24 VDC
H3 = 12 VDC

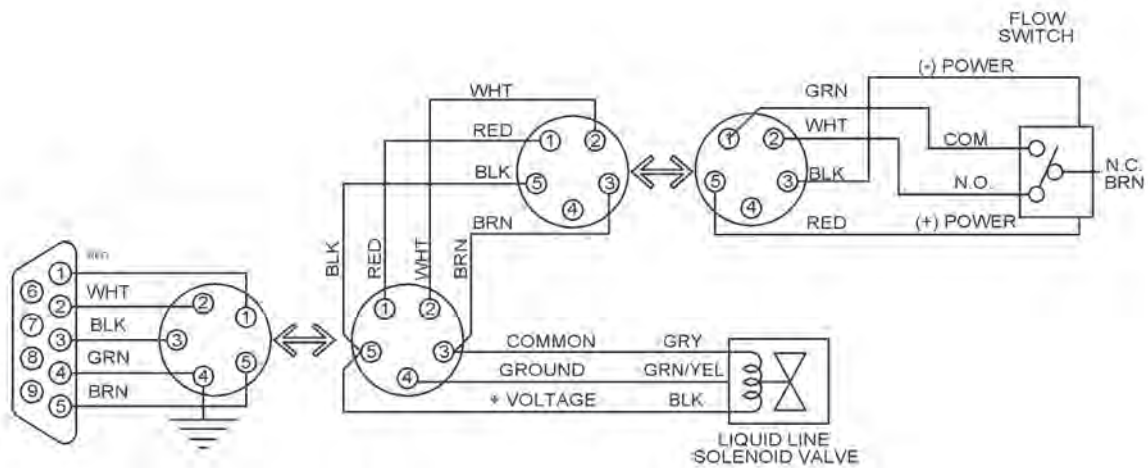

4-20 mA Set Point Control

This feature is optional and may not appear in your version of the software.



NOTE: Two versions are available. If the model number of your Chiller contains an **N** in the 11th digit (e.g., 6860T56A26**N**D), it provides 4-20mA set point control over a temperature range of 5° to 90°C; if the 11th digit is an **K**, the 4-20mA control range is 4° to 40°C

Go to menu item "CC" and set to "YES".

If current input is outside of the range of the 4–20 mA, "Ft 18" will be displayed.

Go to menu item "CC" and set to "YES".
If current input is outside of the range of 4-20ma then "Ft 18" will be displayed.

(-) 10°C to (+) 40°C		14°F to 104°F	
C	mA	F	mA
-10	4.000	14	4.000
-5	5.600	23	5.600
0	7.200	32	7.200
5	8.800	41	8.800
10	10.400	50	10.400
15	12.000	59	12.000
20	13.600	68	13.600
25	15.200	77	15.200
30	16.800	86	16.800
35	18.400	95	18.400
40	20.000	104	20.000

.32mA per °C
.1778mA per °F

(-) 10°C to (+) 90°C		14°F to 194°F	
C	ma	F	ma
-10	4	14	4
-5	4.8	23	4.8
0	5.6	32	5.6
5	6.4	41	6.4
10	7.2	50	7.2
15	8	59	8
20	8.8	68	8.8
25	9.6	77	9.6
30	10.4	86	10.4
35	11.2	95	11.2
40	12	104	12
45	12.8	113	12.8
50	13.6	122	13.6
55	14.4	131	14.4
60	15.2	140	15.2
65	16	149	16
70	16.8	158	16.8
75	17.6	167	17.6
80	18.4	176	18.4
85	19.2	185	19.2
90	20	194	20

.16mA per °C
.08889mA per °F

4-20mA SET POINT CONTROL 15 Pin "D Sub" connector

