

FLUKE®

789/787B

ProcessMeter™

Users Manual

August 2002, Rev. 4, 1/17

© 2002-2017 Fluke Corporation. All rights reserved. Specifications are subject to change without notice.
All product names are trademarks of their respective companies.

LIMITED WARRANTY AND LIMITATION OF LIABILITY

This Fluke product will be free from defects in material and workmanship for three years from the date of purchase. This warranty does not cover fuses, disposable batteries, or damage from accident, neglect, misuse, alteration, contamination, or abnormal conditions of operation or handling. Resellers are not authorized to extend any other warranty on Fluke's behalf. To obtain service during the warranty period, contact your nearest Fluke authorized service center to obtain return authorization information, then send the product to that Service Center with a description of the problem.

THIS WARRANTY IS YOUR ONLY REMEDY. NO OTHER WARRANTIES, SUCH AS FITNESS FOR A PARTICULAR PURPOSE, ARE EXPRESSED OR IMPLIED. FLUKE IS NOT LIABLE FOR ANY SPECIAL, INDIRECT, INCIDENTAL OR CONSEQUENTIAL DAMAGES OR LOSSES, ARISING FROM ANY CAUSE OR THEORY. Since some states or countries do not allow the exclusion or limitation of an implied warranty or of incidental or consequential damages, this limitation of liability may not apply to you.

Fluke Corporation
P.O. Box 9090
Everett, WA 98206-9090
U.S.A.

Fluke Europe B.V.
P.O. Box 1186
5602 BD Eindhoven
The Netherlands

11/99

Table of Contents

Title	Page
Introduction	1
How to Contact Fluke	2
Safety Information	2
How to Get Started	6
Getting Acquainted with the Meter	7
Measuring Electrical Parameters.....	18
Input Impedance.....	18
Ranges	18
Testing Diodes.....	18
Displaying Minimum, Maximum, and Average.....	19
Using AutoHold.....	19
Compensating for Test Lead Resistance.....	20
Using the Current Output Functions	20
Source Mode	20
Simulate Mode.....	22
Producing a Steady mA Output	24
Manually Stepping the mA Output	25
Auto Ramping the mA Output.....	26

Power-Up Options	26
Loop Power Supply Mode (789 only)	28
Battery Life.....	30
Maintenance	30
Calibration.....	31
Replacing the Batteries.....	31
Replacing a Fuse	33
If the Meter does not Work.....	34
Replacement Parts and Accessories	34
Specifications.....	38

ProcessMeter™

Introduction

⚠ Warning

Read “Safety Information” before using the meter.

The Fluke 789/787B ProcessMeter™ (the Meter or Product) is a handheld, battery-operated tool for measuring electrical parameters and supplying steady or ramping current to test process instruments. All illustrations in this manual show the 789 model.

The 789 adds a 24 V loop power supply. It has all the features of a digital multimeter, plus current output capability.

If the meter is damaged or something is missing, contact the place of purchase immediately. Contact a Fluke distributor for information about DMM (digital multimeter) accessories. To order replacement parts or spares, see Table 13 near the end of this manual.

Safety Information

A **Warning** identifies conditions and procedures that are dangerous to the user. A **Caution** identifies conditions and procedures that can cause damage to the Product or the equipment under test.

International symbols used on the meter and in this manual are explained in Table 1.

Warning

To prevent possible electrical shock, fire, or personal injury:

- **Read all safety information before you use the Product.**
- **Carefully read all instructions.**
- **Do not alter the Product and use only as specified, or the protection supplied by the Product can be compromised.**
- **Remove the batteries if the Product is not used for an extended period of time, or if stored in temperatures above 50 °C. If the batteries are not removed, battery leakage can damage the Product.**















- The battery door must be closed and locked before you operate the Product.
- Replace the batteries when the low battery indicator shows to prevent incorrect measurements.
- Comply with local and national safety codes. Use personal protective equipment (approved rubber gloves, face protection, and flame-resistant clothes) to prevent shock and arc blast injury where hazardous live conductors are exposed.
- Do not apply more than the rated voltage, between the terminals or between each terminal and earth ground.
- Do not work alone.
- Limit operation to the specified measurement category, voltage, or amperage ratings.
- Use Product-approved measurement category (CAT), voltage, and amperage rated accessories (probes, test leads, and adapters) for all measurements.
- Measure a known voltage first to make sure that the Product operates correctly.
- Use the correct terminals, function, and range for measurements.
- Do not touch voltages > 30 V ac rms, 42 V ac peak, or 60 V dc.
- Do not use the Product around explosive gas, vapor, or in damp or wet environments.
- Do not use the Product if it operates incorrectly.
- Examine the case before you use the Product. Look for cracks or missing plastic. Carefully look at the insulation around the terminals.
- Do not use test leads if they are damaged. Examine the test leads for damaged insulation, exposed metal, or if the wear indicator shows. Check test lead continuity.

789/787B

Users Manual

- **Keep fingers behind the finger guards on the probes.**
- **Only use probes, test leads, and accessories that have the same measurement category, voltage, and amperage ratings as the Product.**
- **Remove all probes, test leads, and accessories before the battery door is opened.**
- **Remove all probes, test leads, and accessories that are not necessary for the measurement.**
- **Do not exceed the Measurement Category (CAT) rating of the lowest rated individual component of a Product, probe, or accessory.**
- **Do not use test leads if they are damaged. Examine the test leads for damaged insulation and measure a known voltage.**
- **Do not use a current measurement as an indication that a circuit is safe to touch. A voltage measurement is necessary to know if a circuit is hazardous.**
- **Do not use the Product if it is altered or damaged.**
- **Do not use in CAT III or CAT IV environments without the protective cap installed on test probe. The protective cap decreases the exposed probe metal to <4 mm. This decreases the possibility of arc flash from short circuits.**

Table 1. International Symbols

Symbol	Description	Symbol	Description
	WARNING. RISK OF DANGER.		WARNING. HAZARDOUS VOLTAGE. Risk of electric shock.
	Consult user documentation.		Conforms to relevant South Korean EMC Standards
	Conforms to European Union directives	IR	Minimum fuse interrupt rating.
	Certified by CSA Group to North American safety standards.		Conforms to relevant Australian Safety and EMC standards.
	AC (Alternating Current)		Earth
	DC (Direct Current)		Fuse
	Battery		Double Insulated
CAT II	Measurement Category II is applicable to test and measuring circuits connected directly to utilization points (socket outlets and similar points) of the low-voltage MAINS installation.		
CAT III	Measurement Category III is applicable to test and measuring circuits connected to the distribution part of the building's low-voltage MAINS installation.		
CAT IV	Measurement Category IV is applicable to test and measuring circuits connected at the source of the building's low-voltage MAINS installation.		
	This product complies with the WEEE Directive marking requirements. The affixed label indicates that you must not discard this electrical/electronic product in domestic household waste. Product Category: With reference to the equipment types in the WEEE Directive Annex I, this product is classed as category 9 "Monitoring and Control Instrumentation" product. Do not dispose of this product as unsorted municipal waste.		

How to Get Started

Warning

To prevent possible electrical shock, fire, or personal injury:

- **Disconnect power and discharge all high-voltage capacitors before you measure resistance, continuity, capacitance, or a diode junction.**
- **Remove circuit power before you connect the Product in the circuit when you measure current. Connect the Product in series with the circuit.**
- **Do not use the HOLD function to measure unknown potentials. When HOLD is turned on, the display does not change when a different potential is measured.**

If familiar with the Fluke 80 Series DMM, read “Using the Current Output Functions,” review the tables and figures in “Getting Acquainted with the Meter,” and begin using the meter.

If unfamiliar with Fluke 80 Series DMMs, or DMMs in general, read “Measuring Electrical Parameters” in addition to the sections referenced in the previous paragraph.

The sections following “Using the Current Output Functions” contain information about the power-up options, and battery and fuse replacement instructions.

See Table 2 for an overview of the meter.

Table 3. Input/Output Jacks

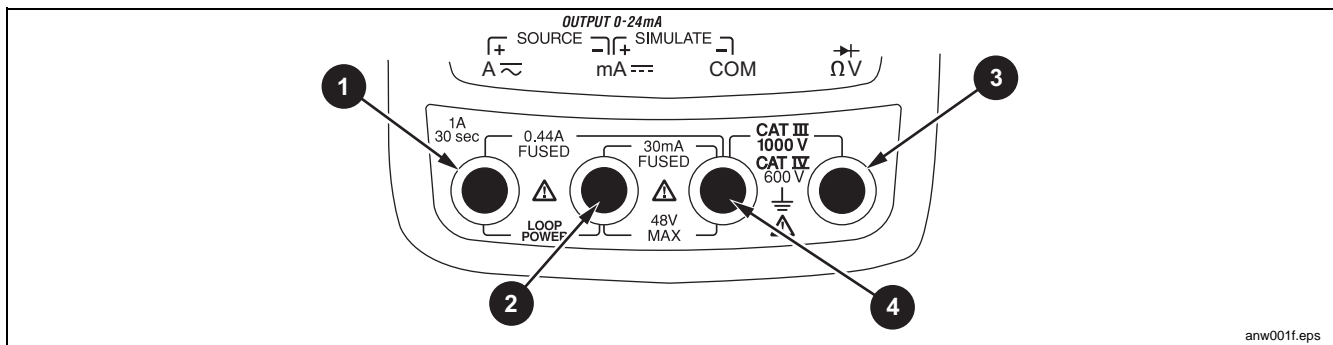

anw001f.eps

Item	Jack	Measurement Functions	Source Current Function	Simulate Transmitter Function
1	A ~	Input for current to 440 mA continuous. (1 A for up to 30 seconds.) Fused with a 440 mA fuse.	Output for dc current to 24 mA. Output for loop power supply (789 only).	
2	mA ---	Input for current to 30 mA. Fused with a 440 mA fuse.	Common for dc current output to 24 mA. Common for loop power supply.	Output for transmitter simulation to 24 mA. (Use in series with an external loop supply.)
3	Ω V	Input for voltage to 1000 V, Ω, continuity, and diode test.		
4	COM	Common for all measurements.		Common for transmitter simulation to 24 mA. (Use in series with an external loop supply.)

Table 4. Rotary Function Switch Positions for Measurements

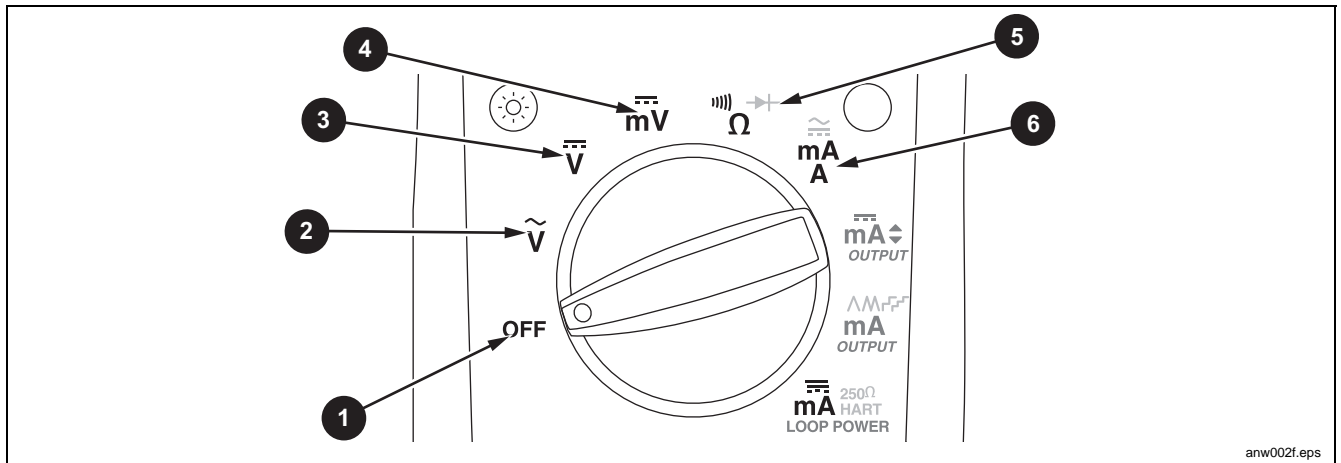

anw002f.eps

No.	Position	Function(s)	Pushbutton Actions
1	OFF	Meter off	
2	\tilde{V}	Default: Measure ac V <input type="text" value="Hz"/> Frequency counter	<input type="button" value="MIN MAX"/> Selects a MIN, MAX, or AVG action <input type="button" value="RANGE"/> Selects a fixed range (hold 1 second for auto range) <input type="button" value="HOLD"/> Toggles AutoHold <input type="button" value="REL Δ"/> Toggles relative reading (sets a relative zero point)

Table 4. Rotary Function Switch Positions for Measurements (cont.)









No.	Position	Function(s)	Pushbutton Actions
3		Default: Measure dc V  Frequency counter	Same as above
4		Default: Measure dc mV  Frequency counter	Same as above (mV has only one range)
5		Default: Measure Ω  for continuity <input type="radio"/> (Blue)  test	Same as above (diode test has only one range)
6		<i>High test lead in \sim A:</i> Measure A dc <input type="radio"/> (Blue) selects ac <i>High test lead in \equiv mA:</i> Measure mA dc	Same as above (only one range for each input jack position, 30 mA or 1 A)

Table 5. Rotary Function Switch Positions for mA Output



anw008f.eps

No.	Position	Default Function	Pushbutton Actions
1	<i>OUTPUT</i> \bar{mA} ↕	<i>Test leads in</i> SOURCE: Source 0 % mA <i>Test leads in</i> SIMULATE: Sink 0 % mA	% STEP ▲ or ▼: Adjusts output up or down to the next 25 % step COARSE ▲ or ▼: Adjusts output up or down 0.1 mA FINE ▲ or ▼: Adjusts output up or down 0.001 mA <div style="display: flex; justify-content: space-around; margin-top: 5px;"> <input type="button" value="0%"/> sets output to 0 % <input type="button" value="100%"/> sets output to 100 % </div>

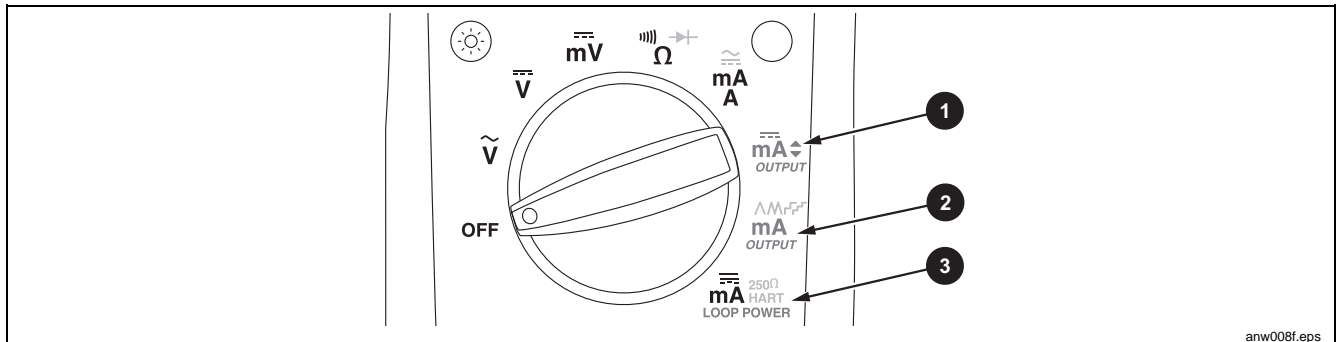
Table 5. Rotary Function Switch Positions for mA Output (cont.)



No.	Position	Default Function	Pushbutton Actions
2	<p>OUTPUT mA </p>	<p>Test leads in SOURCE: Source repeating 0 % -100 %-0 % slow ramp (\wedge) Test leads in SIMULATE: Sink repeating 0 % -100 %-0 % slow ramp (\wedge)</p>	<p><input type="radio"/> (Blue) cycles through:</p> <ul style="list-style-type: none"> • Fast repeating 0 % -100 % - 0 % ramp (\mathcal{M} on display) • Slow repeating 0 % -100 % - 0 % ramp in 25 % steps (\square on display) • Fast repeating 0 % -100 % - 0 % ramp in 25 % steps (\square on display) • Slow repeating 0 % -100 % - 0 % ramp (\wedge on display)
3	<p> (789 only)</p>	<p>Test leads in SOURCE: Supply 24 V loop power, measure mA</p>	<p><input type="radio"/> (Blue) cycles through:</p> <ul style="list-style-type: none"> • 250 Ω series resistor for HART communication switched in • 250 Ω series resistor switched out

Table 6. Pushbuttons







	No.	Pushbutton	Function
 <p>The diagram shows a control panel with several buttons and indicators. Callout 1 points to a backlight icon. Callout 2 points to a 'Span Check' button with a '0%' display. Callout 3 points to a '100%' button. Callout 4 points to a 'MIN MAX' button with a '% STEP' display. Callout 5 points to a 'RANGE' button with a 'COARSE' display. Callout 6 points to a 'HOLD' button with a 'FINE' display. Callout 7 points to a 'REL Δ' button. Callout 8 points to a 'Hz' button. Callout 9 points to a circular button. Callout 10 points to a button with a '% STEP' display.</p>	1		Set the backlight to low, high, and off
	2	Span Check 	<i>mA Output:</i> Adjusts mA output to 0 % value (4 mA or 0 mA)
	3	 Span Check	<i>mA Output:</i> Sets mA output to 100 % value (20 mA)
	4	▲  % STEP	<i>Measuring:</i> Selects a MIN, MAX, or AVG action <i>mA Output:</i> Adjusts mA output up to the next higher 25 % step
	5	▲  COARSE	<i>Measuring:</i> Selects a fixed range (hold for 1 second for auto range) <i>mA Output:</i> Adjusts output up 0.1 mA

Table 6. Pushbuttons (cont.)

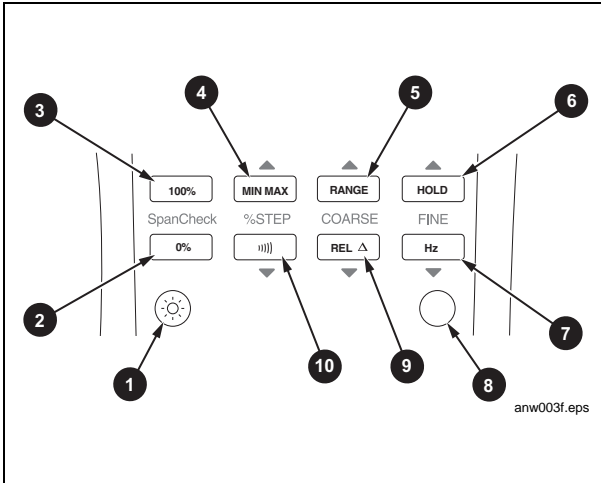



No.	Pushbutton	Function
6		<i>Measuring:</i> Toggles AutoHold, or in MIN MAX recording, suspends recording <i>mA Output:</i> Adjusts output up 0.001 mA
7		<i>Measuring:</i> Toggles between frequency counter and voltage measurement functions <i>mA Output:</i> Adjusts output down 0.001 mA
8		Rotary function switch in $\frac{\approx}{mA}$ position and test lead plugged into A \approx jack: Toggles between ac and dc ampere measure Rotary function switch in $\frac{\approx}{\Omega}$ position: Toggles diode test function ($\rightarrow +$) Rotary function switch in <i>OUTPUT mA</i> \wedge \mathcal{M} μ μ position: cycles through <ul style="list-style-type: none"> • Slow repeating 0 % -100 % - 0 % ramp (\wedge on display) • Fast repeating 0 % -100 % - 0 % ramp (\mathcal{M} on display) • Slow repeating 0 % -100 % - 0 % ramp in 25 % steps (μ on display) • Fast repeating 0 % - 100 % - 0 % ramp in 25 % steps (μ on display) Rotary function switch in loop supply position (789 only) <ul style="list-style-type: none"> • Switch in/out 250 Ω series resistor
9		<i>Measuring:</i> Toggles relative reading (sets a relative zero point) <i>mA Output:</i> Adjusts output down 0.1 mA
10		<i>Measuring:</i> Toggles between Ω measure and continuity functions <i>mA Output:</i> Adjusts mA output down to the next lower 25 % step

Table 7. Display



anw004f.eps

No.	Element	Meaning
1	% (Percentage display)	Shows the mA measured value or output level in %, in a 0-20 mA or 4-20 mA scale (change scales with power-up option)
2	OUTPUT	Lights when mA output (source or simulate) is active
3)))	Lights in continuity function

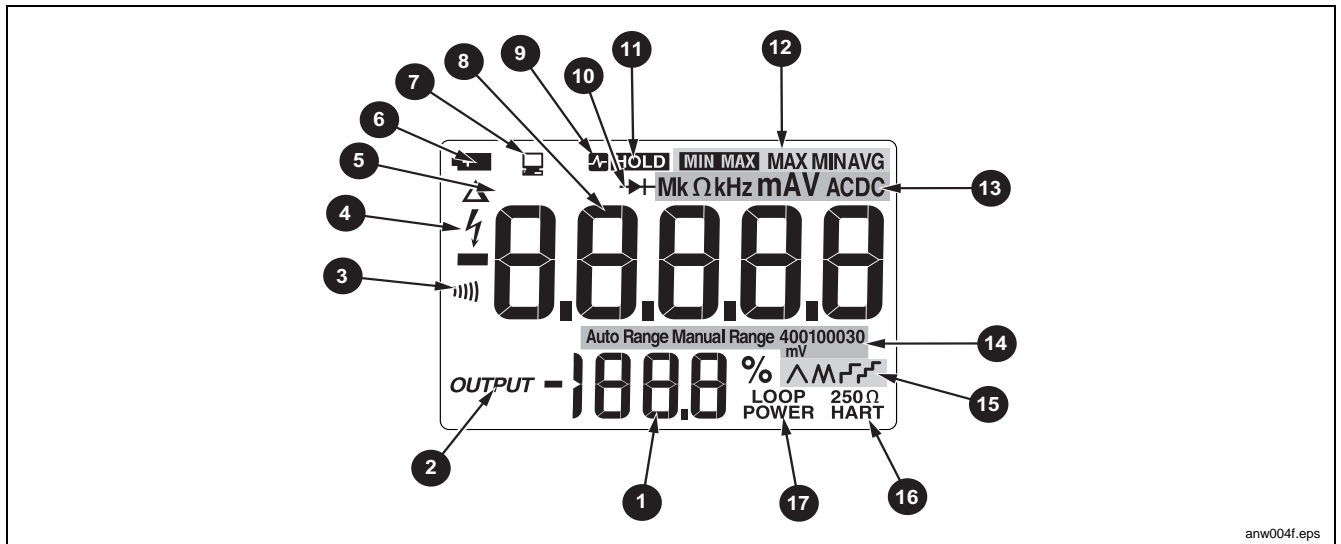
Table 7. Display (cont.)











No.	Element	Meaning
4		Lights when dangerous voltage is detected
5		Lights when relative reading is on
6		Lights when the battery is low
7		Lights when the meter is transmitting or receiving over the IR port
8	Numerals	Show the input or output value
9 11		Lights when AutoHold is on
10		Lights in diode test function
11		Lights when MIN MAX recording is held
12		MIN MAX recording status indicators:  - MIN MAX recording is on MAX - the display is showing the maximum-recorded value MIN - the display is showing the minimum-recorded value AVG - the display is showing the average value
13		Show the input or output units and multipliers associated with the numerals

Table 7. Display (cont.)

No.	Element	Meaning
14	Auto Range Manual Range	Range status indicators: Auto Range - autoranging is on Manual Range - the range is fixed
	400100030 mV	The number plus the unit and multiplier indicate the active range.
15	^ M r r	One of these lights in mA ramping or step output (rotary function switch position mA ^ M r r): ^ - slow continuous 0 % - 100 % - 0 % ramping (40 seconds) M - fast continuous 0 % - 100 % - 0 % ramping (15 seconds) r - slow ramp in 25 % steps (15 seconds/step) r - fast ramp in 25 % steps (5 seconds/step)
16	250 Ω HART	Lights when 250 Ω series resistance is switched in (789 only)
17	Loop Power	Lights when in loop supply mode (789 only)

Measuring Electrical Parameters

The proper sequence for taking measurements is:

1. Plug the test leads into the appropriate jacks.
2. Set the rotary function switch to the desired function.
3. Touch the probes to the test points.
4. View the results on the LCD display.

Input Impedance

For the voltage measurement functions, input impedance is 10 M Ω . See "Specifications" for more information.

Ranges

A measurement range determines the highest value and resolution at which the meter can measure. Most meter measurement functions have more than one range (see "Specifications").

Make sure the correct range is selected:

- If the range is too low, the display shows **OL** (overload).
- If the range is too high, the meter will not be displaying its most precise measurement.

The meter normally selects the lowest range that will measure the applied input signal (Auto Range showing on the display). Press **RANGE** to lock the range. Each time **RANGE** is pressed, the meter selects the next higher range. At the highest range, it returns to the lowest range.

If the range is locked, the meter resumes auto ranging when it is changed to another measurement function or when **RANGE** is pressed and held for 1 second.

Testing Diodes

To test a single diode:

1. Insert the red test lead into the $V\Omega\rightarrow|$ jack and black test lead into the COM jack.
2. Set the rotary function switch to $\Omega\rightarrow|$.
3. Press **○** (Blue) so that the $\rightarrow|$ symbol is on the display.
4. Touch the red probe to the anode and the black probe to the cathode (side with band or bands). The meter should indicate the appropriate diode voltage drop.
5. Reverse the probes. The meter displays OL, indicating high impedance.

The diode is good if it passes the tests in steps 4 and 5.

Displaying Minimum, Maximum, and Average

MIN MAX recording stores the lowest and highest measurements, and maintains the average of all measurements.

Press **MIN MAX** to turn on MIN MAX recording. Readings are stored until the meter is turned off, switched to another measurement or source function, or MIN MAX is turned off. The beeper sounds when a new maximum or minimum is recorded. Auto power-off is disabled and auto ranging is turned off during MIN MAX recording.

Press **MIN MAX** again to cycle through the MAX, MIN, and AVG displays. Press and hold **MIN MAX** for 1 second to erase stored measurements and exit.

In MIN MAX recording, press **HOLD** to suspend recording; press **HOLD** again to resume recording.

Using AutoHold

Note

MIN MAX recording must be off to use AutoHold.

⚠ Warning

To avoid possible electric shock, do not use AutoHold to determine if dangerous voltage is present. AutoHold will not capture unstable or noisy readings.

Activate AutoHold to freeze the meter's display on each new stable reading (except in the frequency counter mode). Press **HOLD** to activate AutoHold. This feature allows measurements to be taken in situations in which it is difficult to look at the display. The meter beeps and updates the display with each new stable reading.

Compensating for Test Lead Resistance

Use the relative reading feature (Δ on the display) to set the present measurement as a relative zero. A common use for this feature is to compensate for test lead resistance when measuring ohms.

Select the Ω measure function, touch the test leads together, and then press **REL Δ** . Until **REL Δ** is pressed again, or the meter is switched to another measurement or source function, the readings on the display will subtract the lead resistance.

Using the Current Output Functions

The meter provides steady, stepped, and ramped current output for testing 0-20 mA and 4-20 mA current loops. Choose source mode, in which the meter supplies the current, simulate mode, in which the meter regulates

current in an externally powered current loop, or loop supply mode, where the meter powers an external device and measures the loop current.

Source Mode

Source mode is selected automatically by inserting the test leads into the SOURCE + and – jacks as shown in Figure 1. The arrows show the conventional current flow. Use source mode whenever it is necessary to supply current into a passive circuit such as a current loop with no loop supply. Source mode depletes the battery faster than simulate mode, so use simulate mode whenever possible.

The display looks the same in source and simulate modes. The way to tell which mode is in use is to see which pair of output jacks is in use.

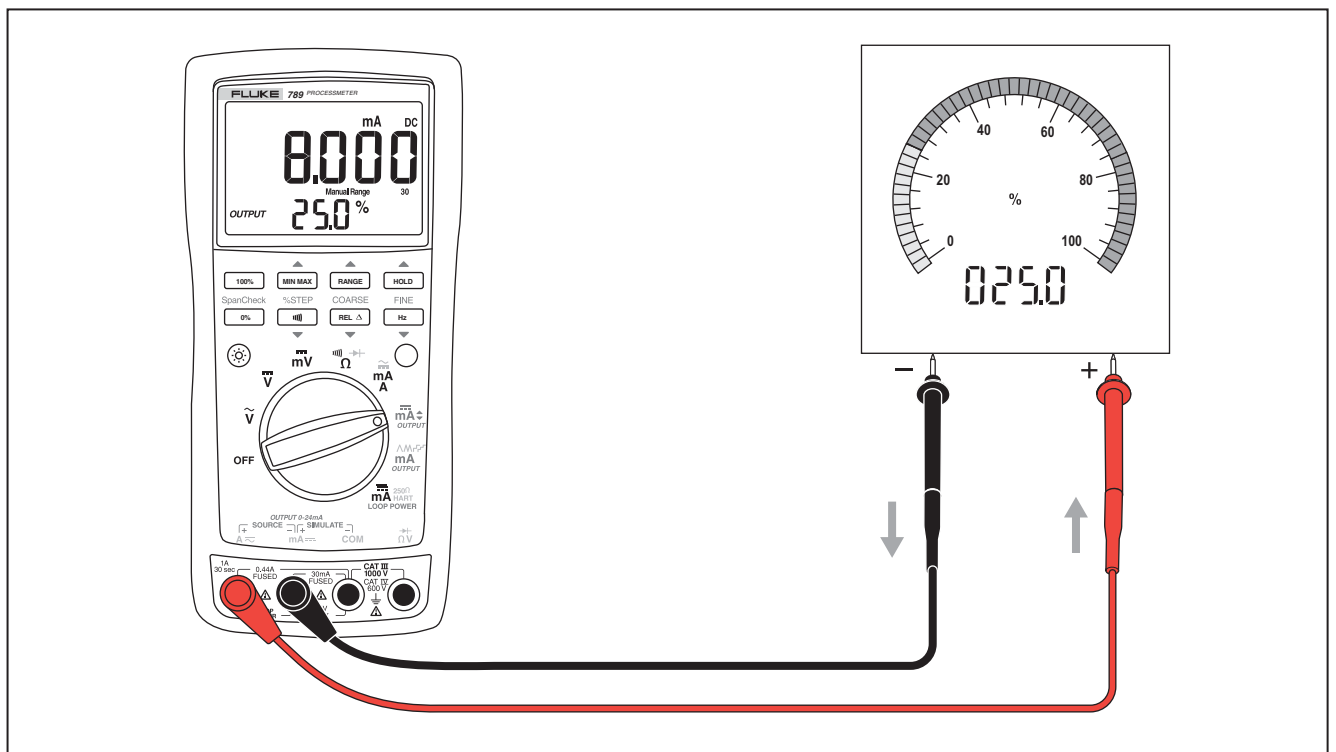

Figure 1. Sourcing Current

anw010f.eps

Simulate Mode

Simulate mode is so named because the meter simulates a current loop transmitter. Use simulate mode when an external dc voltage of 15 to 48 V is in series with the current loop under test.

⚠ Caution

Set the rotary function switch to one of the mA output settings BEFORE connecting the test leads to a current loop. Otherwise, a low impedance from the other rotary function switch positions could be presented to the loop, causing up to 35 mA to flow in the loop.

Simulate mode is selected automatically by inserting the test leads into the SIMULATE + and – jacks as shown in Figure 2. The arrows show the conventional current flow. Simulate mode conserves battery life, so use it instead of source mode whenever possible.

The display looks the same in source and simulate modes. The way to tell which mode is in use is to see which pair of output jacks is in use.

Changing the Current Span

The meter's current output span has two settings (with overrange to 24 mA):

- 4 mA = 0 %, 20 mA = 100 % (factory default)
- 0 mA = 0 %, 20 mA = 100 %

To find out which span is selected, turn the rotary function switch to OUTPUT mA , short the OUTPUT SOURCE + and – jacks, and observe the 0 % output level.

To toggle and save the current output span in nonvolatile memory (retained when the power is turned off):

1. Turn off the meter.
2. Hold down **RANGE** while turning the meter on.
3. Wait at least 2 seconds until the new range shows as 0-20 or 4-20 and then release **RANGE**.

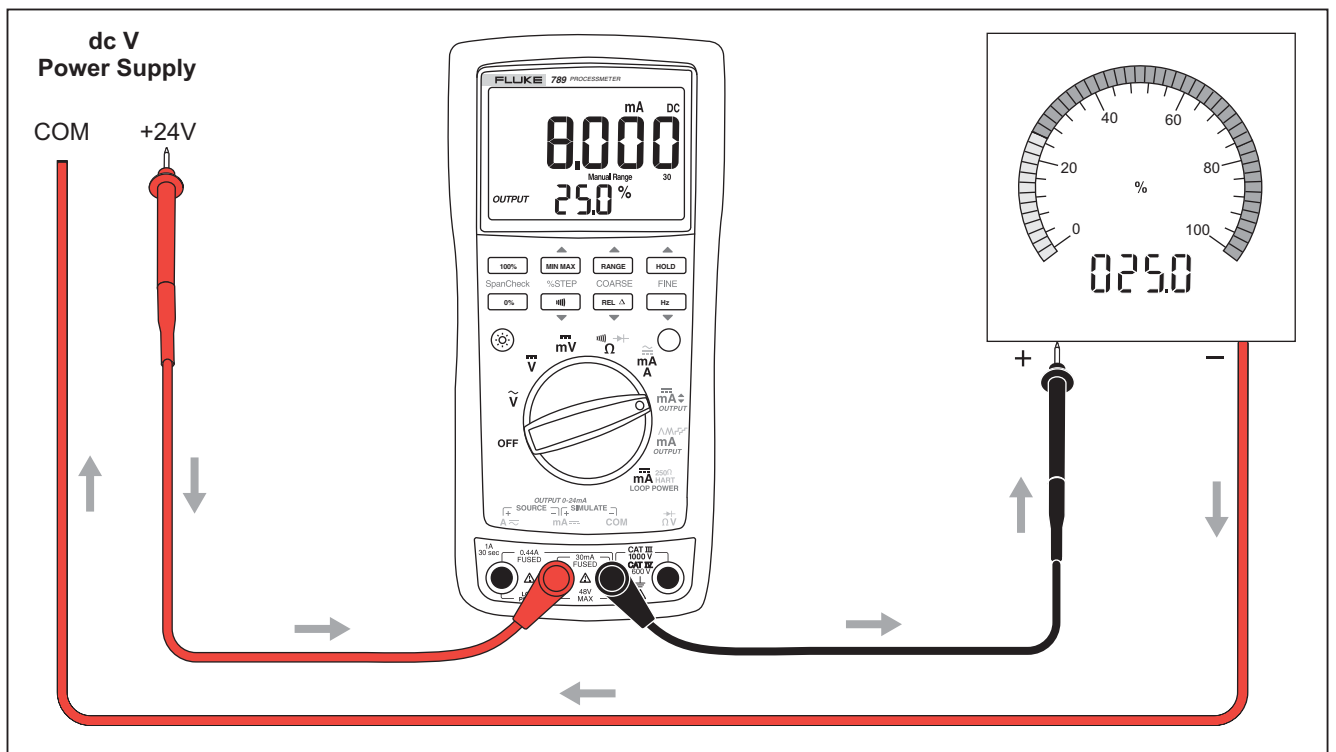

Figure 2. Simulating a Transmitter

anw011f.eps

Producing a Steady mA Output

When the rotary function switch is in the OUTPUT mA \blacklozenge position, and the OUTPUT jacks are connected to an appropriate load, the meter produces a steady mA dc output. The meter begins sourcing or simulating 0 %. Use the pushbuttons to adjust the current as shown in Table 8.

Select either sourcing or simulating by choosing the SOURCE or SIMULATE output jacks.

If the meter cannot deliver the programmed current because the load resistance is too high or the loop supply voltage is too low, dashes (-----) appear on the numeric display. When the impedance between the SOURCE jacks is low enough, the meter will resume sourcing.

Note

The STEP pushbuttons described Table 9 are available when the meter is producing a steady mA output. The STEP pushbuttons go to the next multiple of 25 %.

Table 8. mA Output Adjust Pushbuttons

Pushbutton	Adjustment
▲ RANGE COARSE	Adjusts up 0.1 mA
▲ MIN MAX FINE	Adjusts up 0.001 mA
FINE Hz ▼	Adjusts down 0.001 mA
COARSE REL Δ ▼	Adjusts down 0.1 mA

Manually Stepping the mA Output

When the rotary function switch is in the OUTPUT mA \blacklozenge position, and the OUTPUT jacks are connected to an appropriate load, the meter produces a steady mA dc output. The meter begins sourcing or simulating 0 %. Use the pushbuttons to step the current up and down in 25 % increments as shown in Table 9. See Table 10 for mA values at each 25 % step.

Select either sourcing or simulating by choosing the SOURCE or SIMULATE output jacks.

If the meter cannot deliver the programmed current because the load resistance is too high or the loop supply voltage is too low, dashes (----) appear on the numeric display. When the impedance between the SOURCE jacks is low enough, the meter will resume sourcing.

Note

The COARSE and FINE adjustment pushbuttons described in Table 8 are available when manually stepping the mA output.

Table 9. mA Stepping Pushbuttons





Pushbutton	Adjustment
	Adjusts up to the next higher 25 % step
	Adjusts down to the next lower 25 % step
 Span Check	Sets to 100 % value
 Span Check	Sets to 0 % value





Table 10. mA Step Values

Step	Value (for each span setting)	
	4 to 20 mA	0 to 20 mA
0 %	4.000 mA	0.000 mA
25 %	8.000 mA	5.000 mA
50 %	12.000 mA	10.000 mA
75 %	16.000 mA	15.000 mA
100 %	20.000 mA	20.000 mA
120 %		24.000 mA
125 %	24.000 mA	

Auto Ramping the mA Output

Auto ramping gives the ability to continuously apply a varying current stimulus from the meter to a transmitter, while hands remain free to test the response of the transmitter. Select either sourcing or simulating by choosing the SOURCE or SIMULATE jacks.

When the rotary function switch is in the OUTPUT **mA**  position, and the output jacks are connected to an appropriate load, the meter produces a continuously repeating 0 % - 100 % - 0 % ramp in a choice of four ramp waveforms:

-  0 % - 100 % - 0 % 40-second smooth ramp (default)
-  0 % - 100 % - 0 % 15-second smooth ramp
-  0 % - 100 % - 0 % Stair-step ramp in 25 % steps, pausing 15 seconds at each step. Steps listed in Table 10.
-  0 % - 100 % - 0 % Stair-step ramp in 25 % steps, pausing 5 seconds at each step. Steps are listed in Table 10.

The ramp times are not adjustable. Press  (Blue) to cycle through the four waveforms.

Note

At any time during auto ramping, the ramp can be frozen simply by moving the rotary function switch to the mA  position. Then the COARSE, FINE, and % STEP adjust pushbuttons can be used to make adjustments.









Power-Up Options

To select a power-up option:

1. Push and hold the pushbutton shown in Table 11.
2. Turn the rotary function switch from OFF to the position listed in Table 11.
3. Wait 2 seconds before you release the pushbutton after powering up the Meter.

The setting for current span, backlight, and beeper is retained when the power is turned off. You must repeat the other options for each operating session.

Table 11. Power-Up Options

Option	Button	Switch Position	Default	Display	Action Taken
Current Span		All	Retains setting	0 - 20 or 4 - 20	Toggles between 0-20 mA and 4-20 mA range
Backlight Timeout		All	Retains setting	L on / L off	Enables/Disables the auto-off on backlight after 2 minutes
Beeper		All	Retains setting	b on / b off	Enables/Disables beeper
Auto Power-Off <i>Note: Auto power-off is always disabled when MIN MAX recording is on.</i>	 (Blue)	All	Enabled	PoFF	Disables the feature that turns off the power after 30 minutes of inactivity.
LCD segments		VAC, mA, Source, Ramp, Loop	Disabled	All segments	Display HOLD (as long as button pushed)
Firmware version		VDC	Disabled	ex: 2.0.1	Display firmware version (as long as button is pushed)
Model number		mVDC	Disabled	ex: 789	Display model number (as long as button is pushed)
Go to Calibration mode		Ω	Disabled	[CAL	Calibration mode starts

Loop Power Supply Mode (789 only)

The Loop Power Supply Mode can be used for powering up a process instrument (transmitter). While in Loop Power Mode, the meter acts like a battery. The process instrument regulates the current. At the same time, the meter measures the current that the process instrument is drawing.

The meter supplies loop power at a nominal 24 V dc. An internal series resistance of 250 Ω can be switched in for communication with HART and other smart devices by pressing \odot (Blue). See Figure 3. Pressing \odot (Blue) again switches out this internal resistance.

When loop power is enabled, the meter is configured to measure mA and >24 V dc is sourced between the mA and A jacks. The mA jack is the common and the A jack is at >24 V dc. Connect the meter in series with the instrument current loop. See Figure 4.

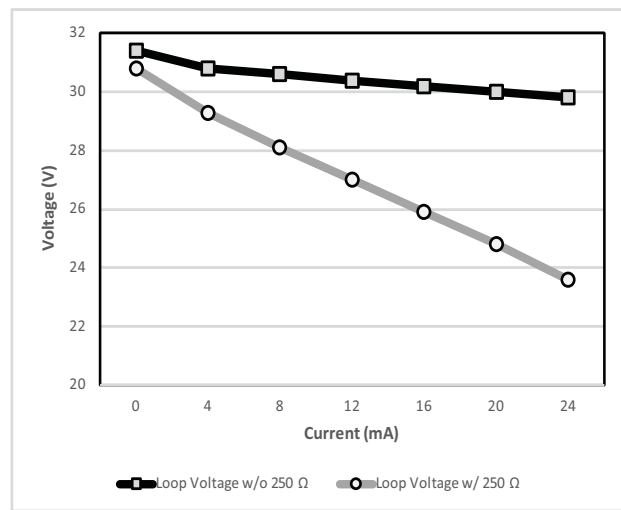

Figure 3. Loop Power Voltage vs. Current

anw020f.eps

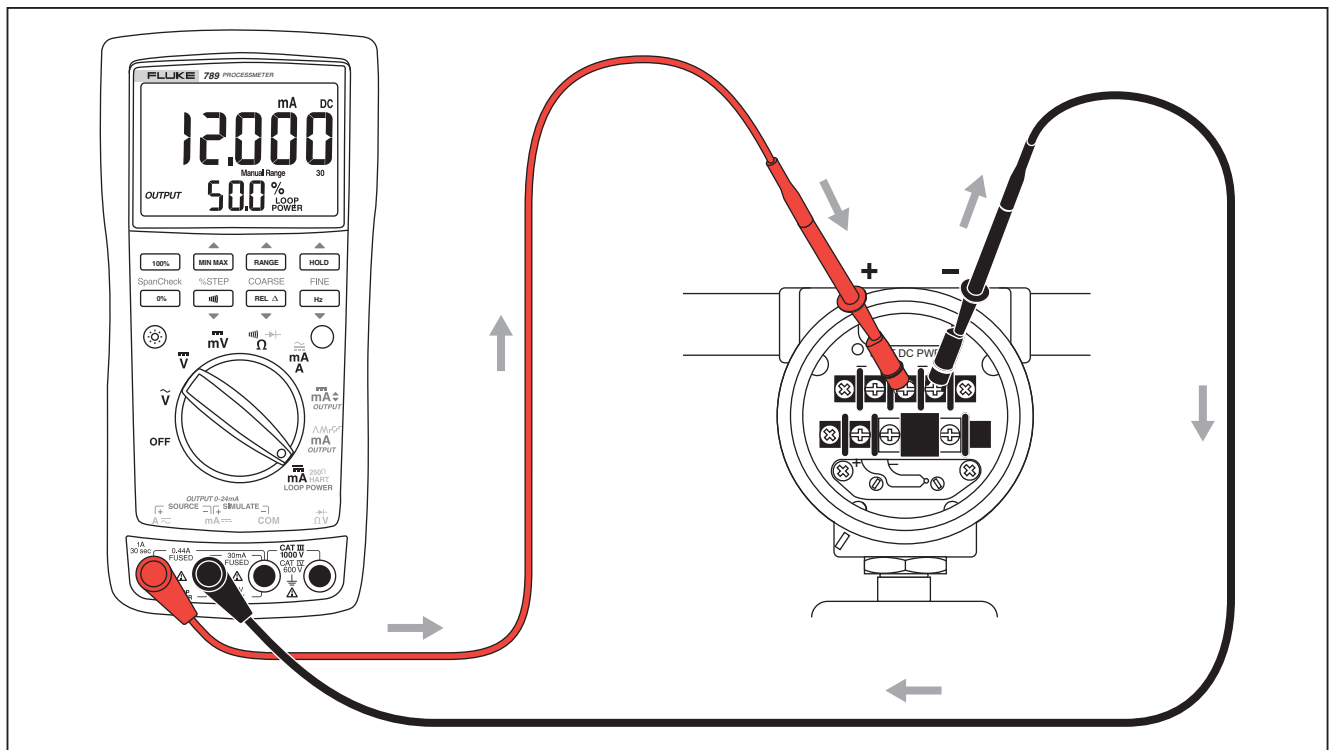

Figure 4. Connections for Supplying Loop Power

anw009f.eps

Battery Life

Warning

To avoid false readings, which could lead to possible electric shock or personal injury, replace the battery as soon as the battery indicator () appears.

Table 12 shows typical alkaline battery life. To preserve battery life:

- Use current simulation instead of sourcing when possible.
- Avoid using the backlight.
- Do not disable the automatic power-off feature.
- Turn the meter off when not in use.

Table 12. Typical Alkaline Battery Life

Meter Operation	Hours
Measuring any parameter	140
Simulating Current	140
Sourcing 12 mA into 500 Ω	10

Maintenance

This section provides some basic maintenance procedures. Repair, calibration, and servicing not covered in this manual must be performed by qualified personnel. For maintenance procedures not described in this manual, contact a Fluke Service Center.

Periodically wipe the case with a damp cloth and detergent; do not use abrasives or solvents.

Warning

To prevent possible electrical shock, fire, or personal injury:

- Do not put battery cells and battery packs near heat or fire. Do not put in sunlight.
- Replace a blown fuse with exact replacement only for continued protection against arc flash.
- Do not operate the Product with covers removed or the case open. Hazardous voltage exposure is possible.
- Use only specified replacement parts.
- Use only specified replacement fuses.
- Have an approved technician repair the Product.

Calibration

Calibrate the meter once a year to ensure that it performs according to its specifications. Contact a Fluke Service Center for instructions.

Replacing the Batteries

⚠ Warning

For safe operation and maintenance, repair the Product before use if the battery leaks.

To replace the batteries:

1. Remove the test leads and turn the Meter OFF. See Figure 5.
2. With a standard blade hand screwdriver, turn each battery door screw counterclockwise so that the slot is parallel with the screw picture molded into the case.
3. Lift off the battery door.
4. Remove the meter's batteries.
5. Replace with four new AA alkaline batteries.
6. Reinstall the battery door and tighten screws.

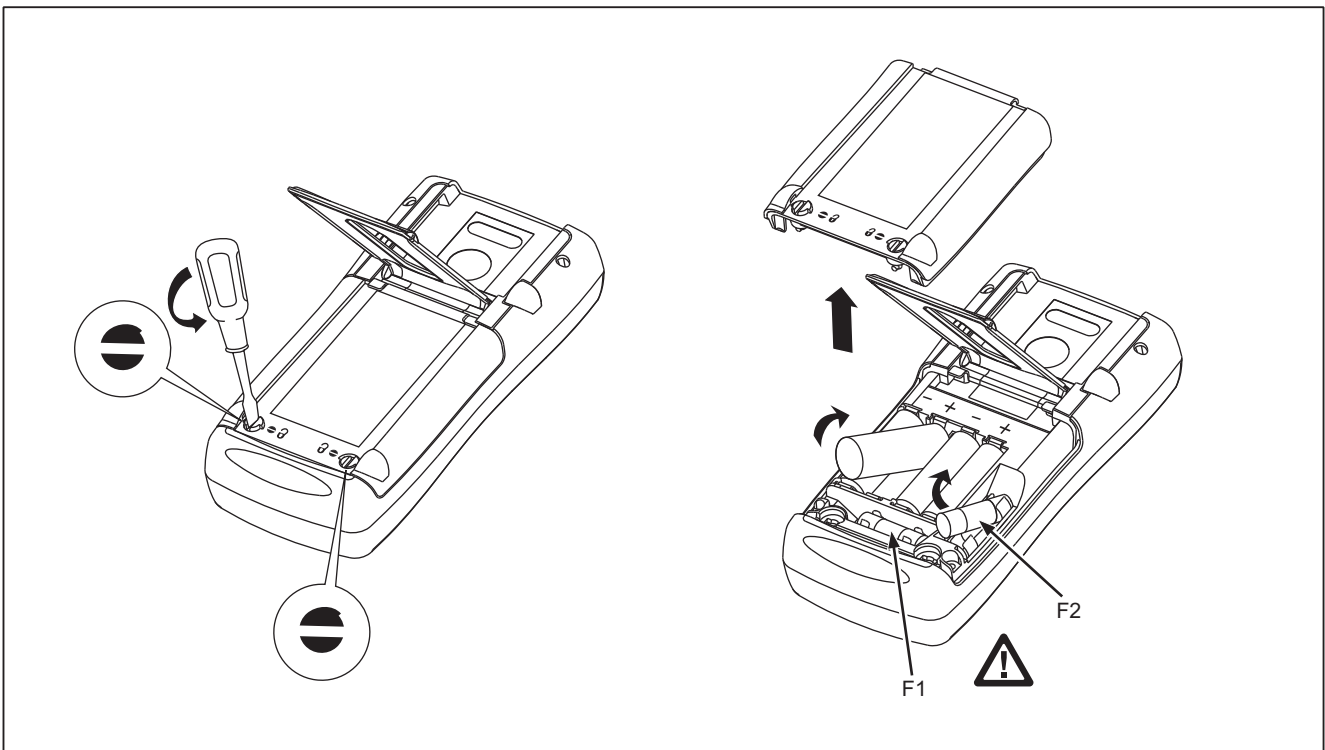

anw037.eps

Figure 5. Replacing the Batteries and Fuses

Replacing a Fuse

Warning

To avoid personal injury or damage to the meter, use only the specified replacement fuse, 440 mA 1000 V fast-blow, Fluke PN 943121.

Both current input jacks are fused with separate 440 mA fuses. To determine if a fuse is blown:

1. Turn the rotary function switch to $\frac{mA}{A}$.
2. Plug the black test lead into COM, and the red test lead into the $A \sim$ input.
3. Using an ohmmeter, check the resistance between the meter test leads. If the resistance is about 1 Ω , the fuse is good. An open reading means that fuse F2 is blown.
4. Move red test lead to mA .
5. Using an ohmmeter, check the resistance between the meter test leads. If the resistance is about 14 Ω , the fuse is good. An open means that fuse F1 is blown.

If a fuse is blown, replace it as follows. Refer to Figure 6 as necessary:

1. Remove the test leads from the meter and turn the meter OFF.
2. With a standard blade hand screwdriver, turn each battery door screw counterclockwise so that the slot is parallel with the screw picture molded into the case.
3. Remove either fuse by gently prying one end loose, then sliding the fuse out of its bracket.
4. Replace the blown fuse(s).
5. Replace the battery access door. Secure the door by turning the screws one-quarter turn clockwise.

If the Meter does not Work

- Examine the case for physical damage. If there is damage, make no further attempt to use the meter, and contact a Fluke Service Center.
- Check the battery, fuses, and test leads.
- Review this manual to make sure you are using the correct jacks and rotary function switch position.

If the meter still does not work, contact a Fluke Service Center. If the meter is under warranty, it will be repaired or replaced (at Fluke's option) and returned at no charge. See the Warranty on the back of the title page for terms. If the warranty has lapsed, the meter will be repaired and returned for a fixed fee. Contact a Fluke Service Center for information and price.

Replacement Parts and Accessories

⚠ Warning

To avoid personal injury or damage to the meter, use only the specified replacement fuse, 440 mA 1000 V fast-blow, Fluke PN 943121.

Note

When servicing the meter, use only the replacement parts specified here.

Replacement parts and some accessories are shown in Figure 6 and listed in Table 13. Many more DMM accessories are available from Fluke. For a catalog, contact the nearest Fluke distributor.

To find out how to order parts or accessories use the telephone numbers or addresses in *How to Contact Fluke*.

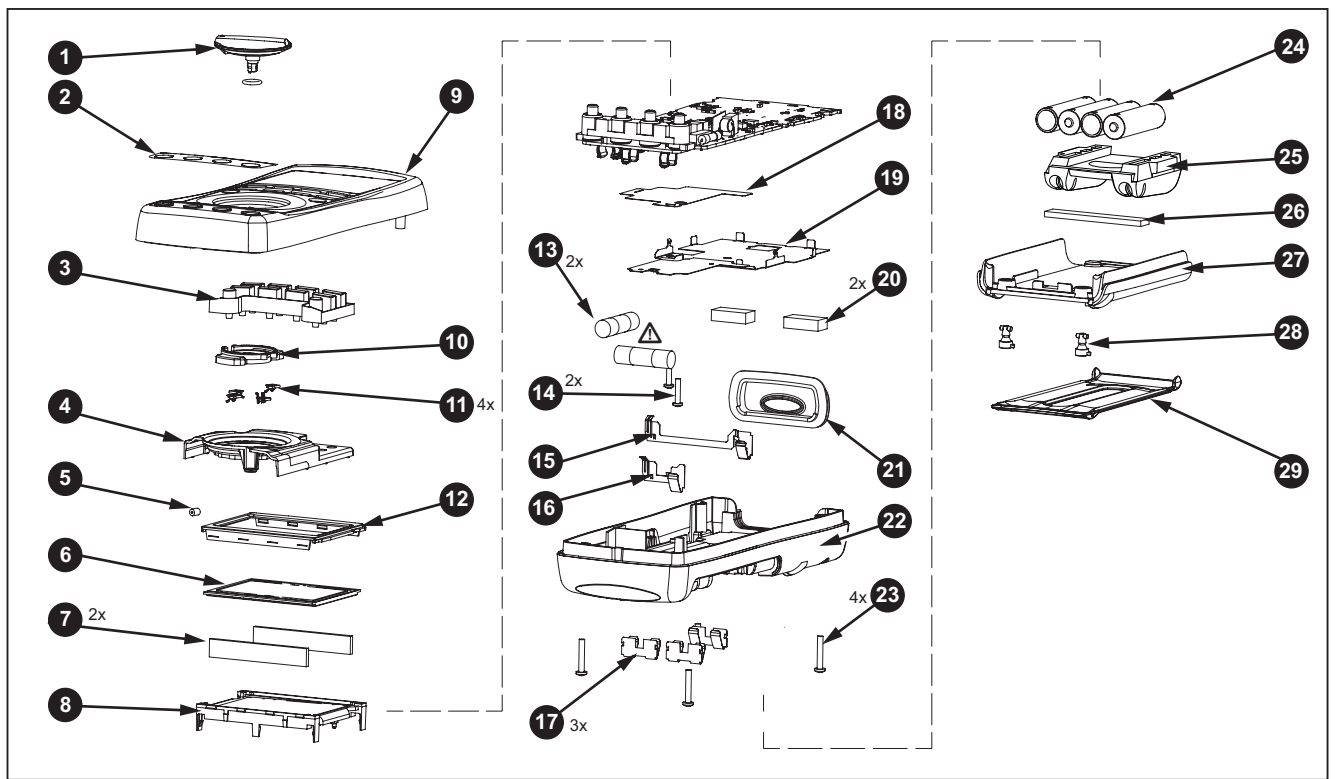

Figure 6. Replacement Parts

anw038.eps

Table 13. Replacement Parts

Item Number	Description	Fluke PN for 789	Fluke PN for 787B	Quantity
1	Knob Assembly with o-ring	658440	4772670	1
2	Decal, Top Case	1623923	4772201	1
3	Keypad	1622951		1
4	Top Shield	4772681		1
5	Top Shield Contact	674853		1
6	LCD Display	1883431		1
7	LCD Connectors, Elastomeric	1641965		2
8	Backlight/Bracket	4756199		1
9	Top Case with Lens Protector	1622855	4772197	1
10	Contact Housing	1622913		1
11	RSOB Contact	1567683		4
12	Mask	1622881	4772655	1
13	 Fuse, 440 mA, 1000 V fast-blow	943121		2
14	PCB Screw	832220		2
15	Battery Contact, Negative	658382		1
16	Battery Contact, Positive	666438		1
17	Battery Contacts Dual	666435		3

Table 13. Replacement Parts (cont.)

Item Number	Description	Fluke PN for 789	Fluke PN for 787B	Quantity
18	Bottom Insulator	4811256		1
19	Bottom Shield	1675171		1
20	Shock Absorber	878983		1
21	IR Lens	658697		1
22	Bottom Case	659042	4772662	1
23	Case Screws	1558745		4
24	Battery, 1.5 V, 0-15 mA, AA Alkaline	376756		4
25	Accessory Mount with Probe Holders	658424		1
26	Shock Absorber	674850		1
27	Access Door, Battery/Fuse	1622870		1
28	Fasteners, Battery/Fuse Access Door	948609		2
29	Tilt-Stand	659026		1
-	Test Leads	variable ^[1]		1 (set of 2)
-	Alligator Clips	variable ^[1]		1 (set of 2)

Specifications

All specifications apply from +18 °C to +28 °C unless stated otherwise.

All specifications assume a 5-minute warm-up period.

The standard specification interval is 1 year.

Note

“Counts” refers to the number of increments or decrements of the least significant digit.

DC Volts Measurement

Range (V dc)	Resolution	Accuracy, ±(% of Reading + Counts)
4.000	0.001 V	0.1 % + 1
40.00	0.01 V	0.1 % + 1
400.0	0.1 V	0.1 % + 1
1000	1 V	0.1 % + 1

Input impedance: 10 MΩ (nominal), < 100 pF
Normal mode rejection ratio: > 60 dB at 50 Hz or 60 Hz
Common mode rejection ratio: > 120 dB at dc, 50 Hz, or 60 Hz
Overvoltage protection: 1000 V

DC Millivolts Measurement

Range (mV dc)	Resolution	Accuracy, ±(% of Reading + Counts)
400.0	0.1 mV	0.1 % + 2

AC Volts Measurement

Range (ac)	Resolution	Accuracy, ±(% of Reading + Counts)		
		50 Hz to 60 Hz	45 Hz to 200 Hz	200 Hz to 500 Hz
400.0 mV	0.1 mV	0.7 % + 4	1.2 % + 4	7.0 % + 4
4.000 V	0.001 V	0.7 % + 2	1.2 % + 4	7.0 % + 4
40.00 V	0.01 V	0.7 % + 2	1.2 % + 4	7.0 % + 4
400.0 V	0.1 V	0.7 % + 2	1.2 % + 4	7.0 % + 4
1000 V	1 V	0.7 % + 2	1.2 % + 4	7.0 % + 4

Specifications are valid from 5 % to 100 % of amplitude range.
 AC conversion: true rms
 Maximum crest factor: 3 (between 50 and 60 Hz)
 For non-sinusoidal waveforms, add ±(2 % reading + 2 % f.s.) typical
 Input impedance: 10 MΩ (nominal), < 100 pF, ac-coupled
 Common mode rejection ratio: > 60 dB at dc, 50 Hz, or 60 Hz

789/787B*Users Manual***AC Current Measurement**

Range 45 Hz to 2 kHz	Resolution	Accuracy, \pm (% of Reading + Counts)	Typical Burden Voltage
1.000 A (Note)	0.001 A	1 % + 2	1.5 V/A
<i>Note: 440 mA continuous, 1 A 30 seconds maximum</i>			
<i>Specifications are valid from 5 % to 100 % of amplitude range.</i>			
<i>AC conversion: true rms</i>			
<i>Maximum crest factor: 3 (between 50 and 60 Hz)</i>			
<i>For non-sinusoidal waveforms, add \pm(2 % reading + 2 % f.s.) typical</i>			
<i>Overload protection 440 mA, 1000 V fast-blow fuse</i>			

DC Current Measurement

Range	Resolution	Accuracy, \pm (% of Reading + Counts)	Typical Burden Voltage
30.000 mA	0.001 mA	0.05 % + 2	14 mV/mA
1.000 A (Note)	0.001 A	0.2 % + 2	1.5 V/A
<i>Note: 440 mA continuous, 1 A 30 seconds maximum</i>			
<i>Overload protection: 440 mA, 1000 V fast-blow fuse</i>			

Ohms Measurement

Range	Resolution	Measurement Current	Accuracy, ±(% of Reading + Counts)
400.0 Ω	0.1 Ω	310 μA	0.2 % + 2
4.000 kΩ	0.001 kΩ	31 μA	0.2 % + 1
40.00 kΩ	0.01 kΩ	2.5 μA	0.2 % + 1
400.0 kΩ	0.1 kΩ	250 nA	0.2 % + 1
4.000 MΩ	0.001 MΩ	250 nA	0.35 % + 3
40.00 MΩ	0.01 MΩ	125 nA	2.5 % + 3
<i>Overload protection: 1000 V</i> <i>Open circuit voltage: <3.9 V</i>			

Frequency Counter Accuracy

Range	Resolution	Accuracy, \pm (% of Reading + Counts)
199.99 Hz	0.01 Hz	0.005 % + 1
1999.9 Hz	0.1 Hz	0.005 % + 1
19.999 kHz	0.001 kHz	0.005 % + 1

Display updates 3 times/second at > 10 Hz

Frequency Counter Sensitivity

Input Range	Minimum Sensitivity (rms Sinewave) 5 Hz to 5 kHz*	
	AC	DC (approximate trigger level 5 % of full scale)
400 mV	150 mV (50 Hz to 5 kHz)	150 mV
4 V	1 V	1 V
40 V	4 V	4 V
400 V	40 V	40 V
1000 V	400 V	400 V

**Usable 0.5 Hz to 20 kHz with reduced sensitivity.
10⁶ VHz max*

Diode Test and Continuity Test

Diode test indicationDisplays voltage drop across device, 2.0 V full scale. Nominal test current 0.3 mA at 0.6 V. Accuracy $\pm(2\% + 1 \text{ count})$.

Continuity test indicationContinuous audible tone for test resistance $<100 \Omega$

Open circuit voltage.....2.9 V

Short circuit current310 μA typical

Overload protection.....1000 V rms

Loop Power Supply Voltage24 V, Short Circuit protected

DC Current Output

Source mode

Span0 mA or 4 mA to 20 mA, with overrange to 24 mA

Accuracy.....0.05 % of span

Compliance voltage.....28 V with battery voltage $>\sim 4.5 \text{ V}$

Simulate Mode

Span0 mA or 4 mA to 20 mA, with overrange to 24 mA

Accuracy.....0.05 % of span

Loop voltage.....24 V nominal, 48 V maximum, 15 V minimum

Compliance voltage.....21 V for 24 V supply

Burden voltage $<3 \text{ V}$

789/787B
Users Manual

General Specifications

Maximum Voltage between any Terminal and Earth Ground	1000 V
Fuse Protection for mA inputs	0.44 A, 1000 V, IR 10 kA
Power	
Battery Type.....	IEC LR6 (AA Alkaline)
Quantity.....	4
Temperature	
Operating	-20 °C to +55 °C
Storage.....	-40 °C to +60 °C
Altitude	
Operating	≤2000 m
Storage.....	≤12 000 m
Frequency Overload Protection	10 ⁶ V Hz max
Temperature coefficient	
Measurements	0.05 x specified accuracy per °C for temperatures <18 °C or >28 °C
Source.....	0.1 x specified accuracy per °C for temperatures <18 °C or >28 °C
Relative humidity	95 % up to 30 °C, 75 % up to 40 °C, 45 % up to 50 °C, and 35 % up to 55 °C
Size	10.0 cm X 20.3 cm X 5.0 cm (3.94 in X 8.00 in X 1.97 in)
Weight	610 g (1.6 lb)
Safety	
General	IEC 61010-1: Pollution Degree 2
Measurement	IEC 61010-2-033: CAT IV 600 V / CAT III 1000 V

Electromagnetic Compatibility (EMC)	Accuracy for all ProcessMeter functions is not specified in RF field >3 V/m
International.....	IEC 61326-1: Portable Electromagnetic Environment; IEC 61326-2-2 CISPR 11: Group 1, Class A <i>Group 1: Equipment has intentionally generated and/or uses conductively-coupled radio frequency energy that is necessary for the internal function of the equipment itself.</i> <i>Class A: Equipment is suitable for use in all establishments other than domestic and those directly connected to a low-voltage power supply network that supplies buildings used for domestic purposes. There may be potential difficulties in ensuring electromagnetic compatibility in other environments due to conducted and radiated disturbances.</i> <i>Caution: This equipment is not intended for use in residential environments and may not provide adequate protection to radio reception in such environments.</i> <i>Emissions that exceed the levels required by CISPR 11 can occur when the equipment is connected to a test object.</i>
Korea (KCC).....	Class A Equipment (Industrial Broadcasting & Communication Equipment) <i>Class A: Equipment meets requirements for industrial electromagnetic wave equipment and the seller or user should take notice of it. This equipment is intended for use in business environments and not to be used in homes.</i>
USA (FCC)	47 CFR 15 subpart B. This product is considered an exempt device per clause 15.103.

772/773

Milliamp Process Clamp Meter

Calibration Manual

LIMITED WARRANTY AND LIMITATION OF LIABILITY

This Fluke product will be free from defects in material and workmanship for 3 years (one year for cable and clamp) from the date of purchase. Parts, product repairs, and services are warranted for 90 days. This warranty extends only to the original buyer or end-user customer of a Fluke authorized reseller, and does not apply to fuses, disposable batteries, or to any product which, in Fluke's opinion, has been misused, altered, neglected, contaminated, or damaged by accident or abnormal conditions of operation or handling. Fluke warrants that software will operate substantially in accordance with its functional specifications for 90 days and that it has been properly recorded on non-defective media. Fluke does not warrant that software will be error free or operate without interruption.

Fluke authorized resellers shall extend this warranty on new and unused products to end-user customers only but have no authority to extend a greater or different warranty on behalf of Fluke. Warranty support is available only if product is purchased through a Fluke authorized sales outlet or Buyer has paid the applicable international price. Fluke reserves the right to invoice Buyer for importation costs of repair/replacement parts when product purchased in one country is submitted for repair in another country.

Fluke's warranty obligation is limited, at Fluke's option, to refund of the purchase price, free of charge repair, or replacement of a defective product which is returned to a Fluke authorized service center within the warranty period.

To obtain warranty service, contact your nearest Fluke authorized service center to obtain return authorization information, then send the product to that service center, with a description of the difficulty, postage and insurance prepaid (FOB Destination). Fluke assumes no risk for damage in transit. Following warranty repair, the product will be returned to Buyer, transportation prepaid (FOB Destination). If Fluke determines that failure was caused by neglect, misuse, contamination, alteration, accident, or abnormal condition of operation or handling, including overvoltage failures caused by use outside the product's specified rating, or normal wear and tear of mechanical components, Fluke will provide an estimate of repair costs and obtain authorization before commencing the work. Following repair, the product will be returned to the Buyer transportation prepaid and the Buyer will be billed for the repair and return transportation charges (FOB Shipping Point).

THIS WARRANTY IS BUYER'S SOLE AND EXCLUSIVE REMEDY AND IS IN LIEU OF ALL OTHER WARRANTIES, EXPRESS OR IMPLIED, INCLUDING BUT NOT LIMITED TO ANY IMPLIED WARRANTY OF MERCHANTABILITY OR FITNESS FOR A PARTICULAR PURPOSE. FLUKE SHALL NOT BE LIABLE FOR ANY SPECIAL, INDIRECT, INCIDENTAL OR CONSEQUENTIAL DAMAGES OR LOSSES, INCLUDING LOSS OF DATA, ARISING FROM ANY CAUSE OR THEORY.

Since some countries or states do not allow limitation of the term of an implied warranty, or exclusion or limitation of incidental or consequential damages, the limitations and exclusions of this warranty may not apply to every buyer. If any provision of this Warranty is held invalid or unenforceable by a court or other decision-maker of competent jurisdiction, such holding will not affect the validity or enforceability of any other provision.

Fluke Corporation
P.O. Box 9090
Everett, WA 98206-9090
U.S.A.

Fluke Europe B.V.
P.O. Box 1186
5602 BD Eindhoven
The Netherlands

ООО «Флюк СИИЭС»
125167, г. Москва, Ленинградский
проспект дом 37,
корпус 9, подъезд 4, 1 этаж

11/99

Table of Contents

Title	Page
Introduction	1
How to Contact Fluke.....	2
Safety Information	2
Symbols	5
Specifications	6
Electrical Specifications	6
Mechanical Specifications	7
Environmental Specifications	7
Miscellaneous Specifications.....	7
Basic Maintenance.....	9
How to Clean the Meter.....	9
Battery Replacement	9
Performance Tests.....	10
Required Equipment.....	10
How to Test the Batteries	11
How to Test the Display.....	11
Display Hold Test.....	11
Backlight Test	11
Measurement Spotlight LED Test.....	11
Accuracy Tests.....	12
mA DC Clamp Measure Accuracy Tests	12
mA DC Measure Accuracy Tests	12
Volts DC Measure Accuracy Tests	13
mA DC Source Accuracy Tests	13
Volts DC Source Accuracy Tests	13
Calibration Adjustment	14
Calibration Error Messages	15
mA DC Clamp Measure Adjustment Procedure.....	16
mA DC Measure Adjustment Procedure	16
Volts DC Measure Adjustment Procedure.....	16
mA DC Source Adjust Procedure	17
Volts DC Source Adjust Procedure (773 Only).....	17
Replaceable Parts.....	18

Introduction

Warning

To prevent electrical shock or personal injury, do not do the calibration verification tests or calibration procedures in this manual unless you are qualified.

The data in this manual is for qualified personnel only.

This manual tells you about verification and adjustment procedures for the 772/773 Milliamp Process Clamp Meter (referred to in this manual as the Meter or Product). The Meter features closed-case calibration to use with reference sources. It measures the reference signals, calculates the correction factors, and keeps them in memory. Calibration adjustment is required after a repair, or if the Meter fails a performance test.

This manual explains:

- Precautions and Safety Information
- Specifications
- Basic Maintenance
- Calibration/Verification Procedure
- Replaceable Parts and Accessories

For complete use instructions, refer to the *772/773 Instruction Sheet*.

Safety Information

A **Warning** identifies conditions and procedures that are dangerous to the user. A **Caution** identifies conditions and procedures that can cause damage to the Product or the equipment under test.

Warning

To prevent possible electrical shock, fire, or personal injury:

- Carefully read all instructions.
- Do not alter the Product and use only as specified, or the protection supplied by the Product can be compromised.
- Read all safety information before you use the Product.
- Do not use in CAT III or CAT IV environments without the protective cap installed on test probe. The protective cap decreases the exposed probe metal to <4 mm. This decreases the possibility of arc flash from short circuits.
- Comply with local and national safety codes. Use personal protective equipment (approved rubber gloves, face protection, and flame-resistant clothes) to prevent shock and arc blast injury where hazardous live conductors are exposed.
- Do not touch voltages >30 V ac rms, 42 V ac peak, or 60 V dc.
- Remove the batteries if the Product is not used for an extended period of time, or if stored in temperatures above 50 °C. If the batteries are not removed, battery leakage may result.

- The battery door must be closed and locked before you operate the Product.
- Replace the batteries when the low battery indicator shows to prevent incorrect measurements.
- Do not apply more than the rated voltage, between the terminals or between each terminal and earth ground.
- Measure a known voltage first to make sure that the Product operates correctly.
- Use the Clamp only on insulated conductors. Use caution around bare conductors or bus bars. To prevent electrical shock, do not touch the conductor.
- Do not use test leads if they are damaged. Examine the test leads for damaged insulation, exposed metal, or if the wear indicator shows. Check test lead continuity.
- Hold the Product behind the tactile barrier. See Figure 1.
- Keep fingers behind the finger guards on the probes.
- Remove all probes, test leads, and accessories before the battery door is opened.
- Remove all probes, test leads, and accessories that are not necessary for the measurement.
- Do not exceed the Measurement Category (CAT) rating of the lowest rated individual component of a Product, probe, or accessory.
- Do not use the Product if it operates incorrectly.
- Disable the Product if it is damaged.
- Do not make connections on hazardous live conductors in damp or wet environments.

⚠ Caution

To prevent damage to the Meter, do not open it. Do not use a solvent to clean the Meter, and do not put the Meter in water.

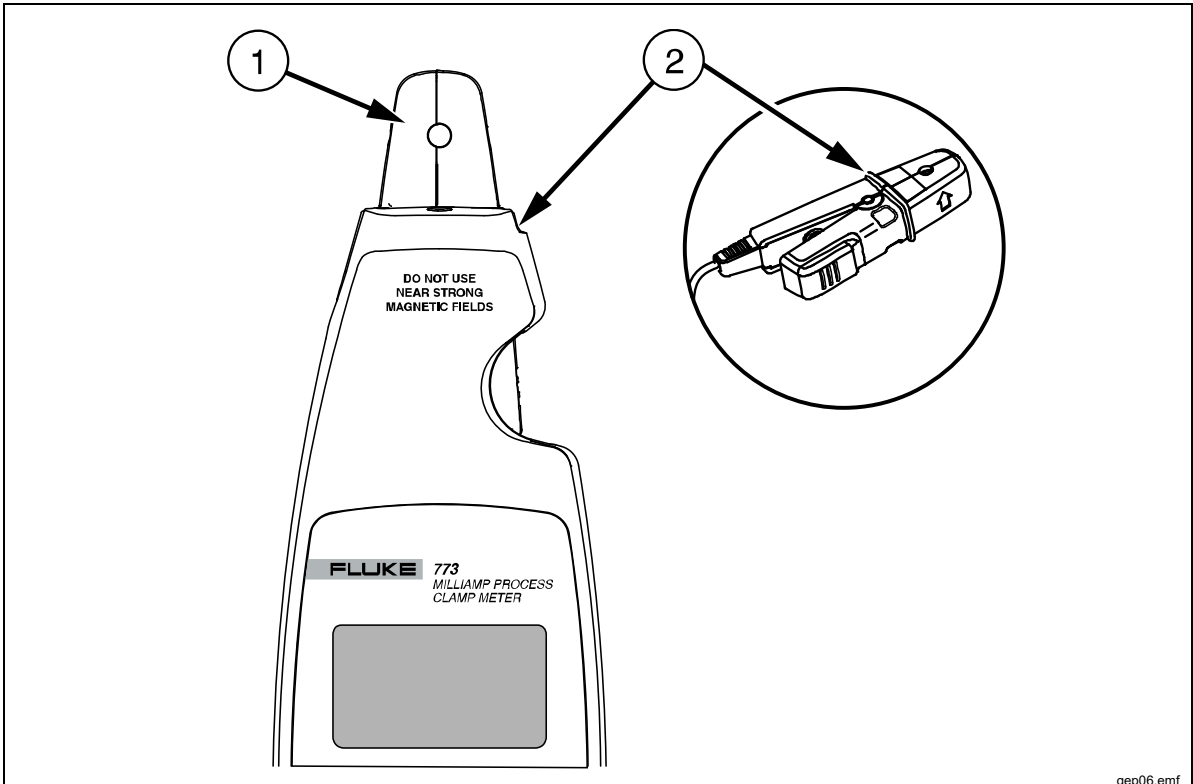

gep06.emf













Number	Description
①	Detachable clamp
②	Tactile Barrier docked and un-docked.

Figure 1. Tactile Barrier

Symbols

Table 1 is a list of the symbols that are on the Meter or in this manual.

Table 1. Symbols

Symbol	Explanation
	Consult user documentation.
	WARNING. RISK OF DANGER.
	WARNING. HAZARDOUS VOLTAGE. Risk of electric shock.
	Power on/off
	Do not apply around or remove from uninsulated hazardous live conductors without taking additional protective measures.
	Double Insulated
	DC (Direct Current)
	Earth Ground
	Battery
	Conforms to European Union directives.
	Conforms to relevant Australian Safety and EMC standards.
	Certified by CSA Group to North American safety standards.
CAT II	Measurement Category II is applicable to test and measuring circuits connected directly to utilization points (socket outlets and similar points) of the low-voltage MAINS installation.
CAT III	Measurement Category III is applicable to test and measuring circuits connected to the distribution part of the building's low-voltage MAINS installation.
CAT IV	Measurement Category IV is applicable to test and measuring circuits connected at the source of the building's low-voltage MAINS installation.
	This product complies with the WEEE Directive marking requirements. The affixed label indicates that you must not discard this electrical/electronic product in domestic household waste. Product Category: With reference to the equipment types in the WEEE Directive Annex I, this product is classed as category 9 "Monitoring and Control Instrumentation" product. Do not dispose of this product as unsorted municipal waste.

Specifications

Electrical Specifications

DC Current Measurement

With Jaw

Ranges 0 mA to 20.99 mA, 21 mA to 100 mA
Resolution 0.01 mA, 0.1 mA
Accuracy..... 0.2 % + 5 counts, 1 % + 5 counts

In Circuit

Range 0 mA to 24 mA
Resolution 0.01 mA
Accuracy..... 0.2 % + 2 counts

Current Source

Range 0 mA to 24 mA
Resolution 0.01 mA
Accuracy..... 0.2 % + 2 counts
mA Drive..... 24 mA into 1000 Ω

Current Simulate

Range 0 mA to 24 mA
Resolution 0.01 mA
Accuracy..... 0.2 % + 2 counts
Maximum Voltage 50 V

DC Voltage Measurement (773)

Range 0-30 V
Resolution..... 0.01 V
Accuracy..... 0.2 % + 2 counts

DC Voltage Source (773)

Range 0 V to 30 V
Resolution 0.01 V
Accuracy..... 0.2 % + 2 counts
mA Drive..... 2 mA maximum all conditions

mA DC IN/OUT (773)

Sourcing range 0 mA to 24 mA
Sourcing resolution 0.01 mA
Sourcing accuracy 0.2 % + 2 counts
Measurement range 0 mA to 24 mA
Measurement resolution 0.01 mA
Measurement accuracy 1 % FS

Scaled mA DC Current Output to mA Current Input from the Jaw (773)

Range 0 mA to 24 mA
Resolution 0.01 mA
Accuracy..... 1 % FS
Response speed..... 2x/second
DC Loop Power 24 V
Influence of Earth's Field <0.20 mA
Batteries 4 1.5 V, Alkaline, IEC LR6
Working hours 12 hours @ 12 mA sourced into 500 Ω



Static Awareness



Semiconductors and integrated circuits can be damaged by electrostatic discharge during handling. This notice explains how to minimize damage to these components.

1. Understand the problem.
2. Learn the guidelines for proper handling.
3. Use the proper procedures, packaging, and bench techniques.

Follow these practices to minimize damage to static sensitive parts.

Warning

To prevent electric shock or personal injury. De-energize the product and all active circuits before opening a product enclosure, touching or handling any PCBs or components.



- Minimize handling.
- Handle static-sensitive parts by non-conductive edges.
- Do not slide static-sensitive components over any surface.
- When removing plug-in assemblies, handle only by non-conductive edges.
- Never touch open-edge connectors except at a static-free work station.

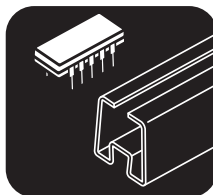

- Keep parts in the original containers until ready for use.
- Use static shielding containers for handling and transport.
- Avoid plastic, vinyl, and Styrofoam® in the work area.



- Handle static-sensitive parts only at a static-free work station.
- Put shorting strips on the edge of the connector to help protect installed static-sensitive parts.
- Use anti-static type solder extraction tools only.
- Use grounded-tip soldering irons only.

Basic Maintenance

Warning

To prevent possible electric shock, fire, or personal injury:

- Remove the input signals before you clean the Product.
- Repairs or servicing not covered in this manual should be performed only by qualified personnel.
- Replace all batteries with fresh batteries of the same manufacturer and type to prevent battery leakage.

How to Clean the Meter

Caution

To prevent damage to the Meter, do not use aromatic hydrocarbons or chlorinated solvents when you clean the Meter. These solutions react with the plastics used in the Meter.

Clean the instrument case with a damp cloth and mild detergent.

Battery Replacement

Warning

To prevent possible electric shock, fire, or personal injury:

- To avoid false readings, that could lead to possible electrical shock or personal injury, replace the batteries as soon as the battery indicator () appears.
- Remove test leads before changing the batteries.

To replace the batteries, see Figure 2:

1. Turn the Meter off.
2. Use a flat-head screwdriver to loosen the battery compartment door screws and remove the door from the case bottom.
3. Remove the batteries.
4. Replace the batteries with four new AA batteries.
5. Reattach the battery compartment door to the case bottom and tighten the screws.

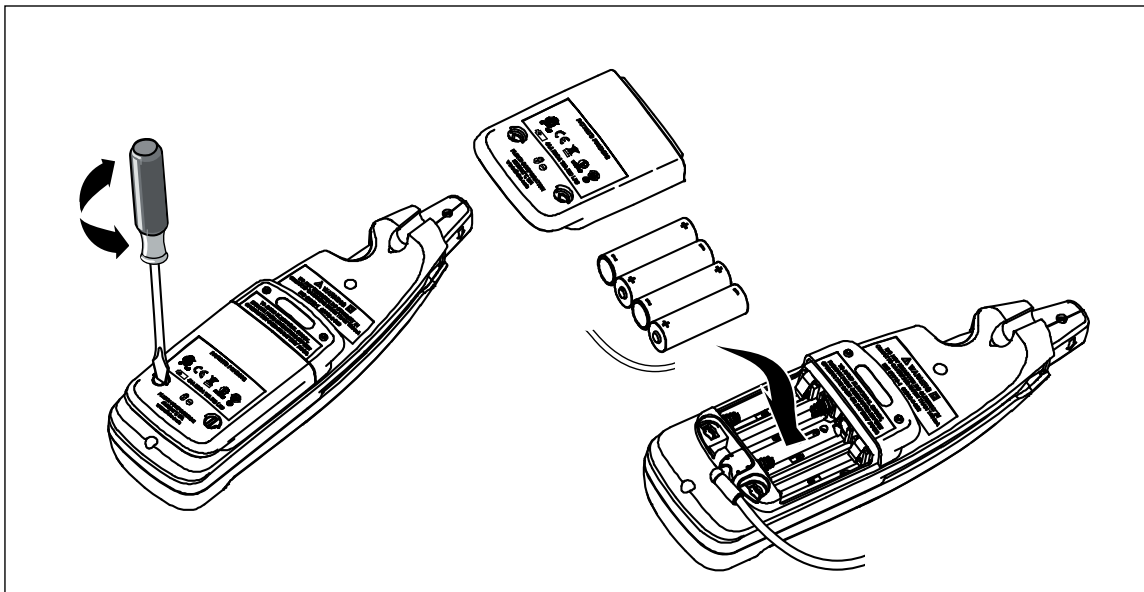

Figure 2. Battery Replacement

gep02.emf

Performance Tests

⚠️ Warning

To prevent electrical shock, personal injury, or fire:

- Repairs or Meter servicing must be done only by qualified personnel.
- Do not do the verification tests or calibration adjustment in this manual unless qualified.

The tests that follow verify the functions of the Meter. If the Meter fails the verification tests, repair is necessary. For Meter servicing, see *How to Contact Fluke*.

Required Equipment

Required equipment for the performance tests is in Table 2. If the recommended models are not available, equipment with equivalent specifications can be used.

Table 2. Required Equipment

Equipment	Minimum Required Characteristics	Recommended Model
Calibrator	DC milliamps: 0-24.00 mA = ± 0.073 % 24.0-100.0 mA = ± 0.375 % DC Volts: 0-30.00 V = ± 0.267 %	Fluke 55xxA
DMM	DC Current: 0-24.00 mA = ± 0.375 % DC Volts: 0-10 V = ± 0.1 %	Fluke 88xxA
Lab Supply	6 Vdc ± 0.5 V	-

How to Test the Batteries

Prior to performing the following tests, check the batteries with a multimeter and replace as necessary. See *Battery Replacement*.

How to Test the Display

1. Push and hold **HOLD** while powering on the Meter.
2. Compare the Meter display to Figure 3.
3. Examine all display segments for clarity and contrast.

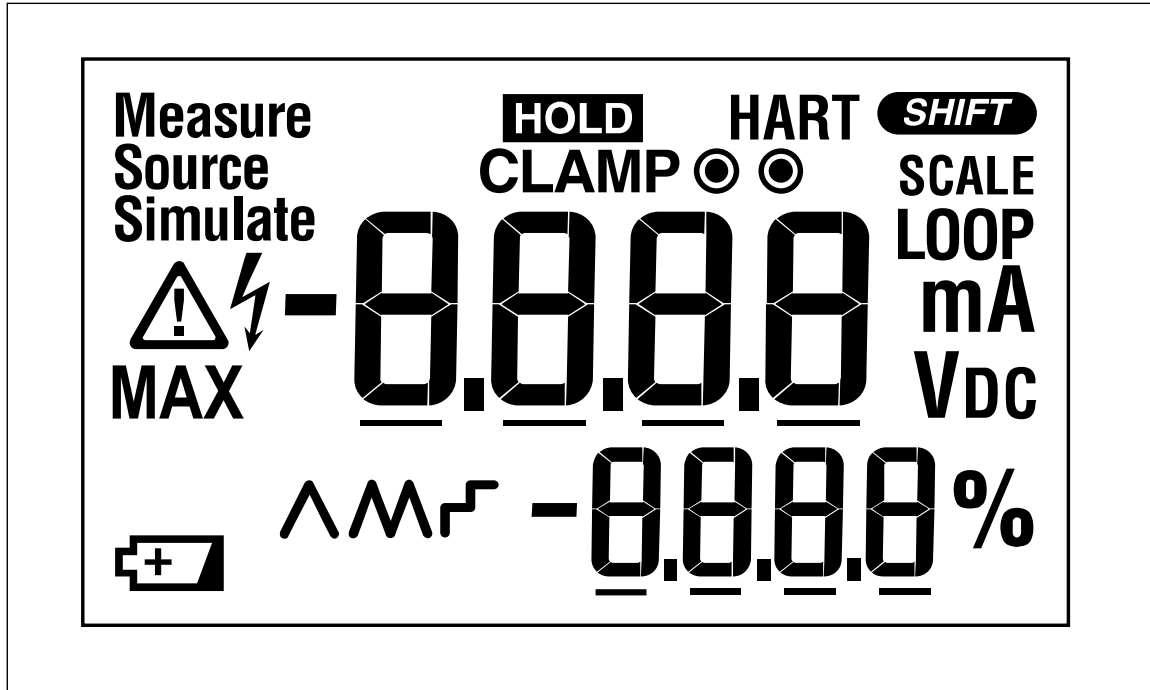

Figure 3. Display Test

gep07.emf

Display Hold Test

Warning

To prevent possible electrical shock, fire, or personal injury:

- Be aware of the measurement being taken when using Display HOLD. When Display HOLD is activated, the display will not change when different currents are applied.
- Do not use the HOLD function to measure unknown potentials. When HOLD is turned on, the display does not change when a different potential is measured.

Push **HOLD** to activate Display Hold mode. The display shows **HOLD** and the display freezes. Push **HOLD** a second time to exit and resume normal operation.

Backlight Test

Push  to turn the backlight on and off. To extend battery life, the backlight automatically stops after 2 minutes.

Measurement Spotlight LED Test

Push  to activate the Measurement Spotlight LED. To extend battery life, the light automatically stops after 2 minutes.

Accuracy Tests

Accuracy specifications are valid for 1 year after calibration adjustment when measured at an operation temperature of 18 °C to 28 °C. Allow the Meter to stabilize at room temperature prior to performing the accuracy tests.

The following tables list the required performance test points for verifying Meter accuracy. Zero the Meter prior to completing each measurement point.

mA DC Clamp Measure Accuracy Tests

Step	Calibrator Output	UUT Meter Reading Limit	
		Low	High
1	4.00 mA	3.94 mA	4.06 mA
2	-4.00 mA	-4.06 mA	-3.94 mA
3	12.00 mA	11.03 mA	12.07 mA
4	-12.00 mA	-12.07 mA	-11.03 mA
5	20.00 mA	19.01 mA	20.09 mA
6	-20.00 mA	-20.09 mA	-19.01 mA
7	100.0 mA	98.5 mA	101.5 mA
8	-100.0 mA	-101.5 mA	-98.5 mA

mA DC Measure Accuracy Tests

Step	Calibrator Output	UUT Meter reading limit	
		Low	High
1	0.00 mA	-0.02 mA	0.02 mA
2	4.00 mA	3.97 mA	4.03 mA
3	-4.00 mA	-4.03 mA	-3.97 mA
4	8.00 mA	7.96 mA	8.04 mA
5	-8.00 mA	-8.04 mA	-7.96 mA
6	12.00 mA	11.96 mA	12.04 mA
7	-12.00 mA	-12.04 mA	-11.96 mA
8	20.00 mA	19.94 mA	20.06 mA
9	-20.00 mA	-20.06 mA	-19.94 mA
10	24.00 mA	23.93 mA	24.07 mA
11	-24.00 mA	-24.07 mA	-23.93 mA

Volts DC Measure Accuracy Tests

Step	Calibrator Output	UUT Meter Reading Limit	
		Low	High
1	0.00 V	-0.02 V	0.02 V
2	10.00 V	9.96 V	10.04 V
3	-10.00 V	-10.04 V	-9.96 V
4	20.00 V	19.94 V	20.06 V
5	-20.00 V	-20.06 V	-19.94 V
6	30.00 V	29.92 V	30.08 V
7	-30.00 V	-30.08 V	-29.92 V

mA DC Source Accuracy Tests

Step	UUT Meter Output	DMM Reading Limit	
		Low	High
1	0.00 mA	-0.02 mA	0.02 mA
2	4.00 mA	3.97 mA	4.03 mA
3	8.00 mA	7.96 mA	8.04 mA
4	12.00 mA	11.96 mA	12.04 mA
5	20.00 mA	19.94 mA	20.06 mA
6	24.00 mA	23.93 mA	24.07 mA

Volts DC Source Accuracy Tests

Step	UUT Meter Output	DMM Reading Limit	
		Low	High
1	0.00 V	-0.02 V	0.02 V
2	2.50 V	2.47 V	2.53 V
3	5.00 V	4.97 V	5.03 V
4	7.50 V	7.46 V	7.54 V
5	10.00 V	9.96 V	10.04 V

Calibration Adjustment

The Meter features closed-case calibration adjustment with a known reference source. The Meter measures the applied reference source, calculates correction factors, and keeps the correction factors in nonvolatile memory.

Before you start calibration adjustment, let the Meter stabilize to room temperature.

To turn on Calibration mode:

1. Remove the batteries and substitute with a lab supply set to 6 V dc.
2. Open the battery door. The calibration button is usually hidden by the factory calibration seal.
3. Use a small probe and push the calibration button longer than 2 seconds. See Figure 4.

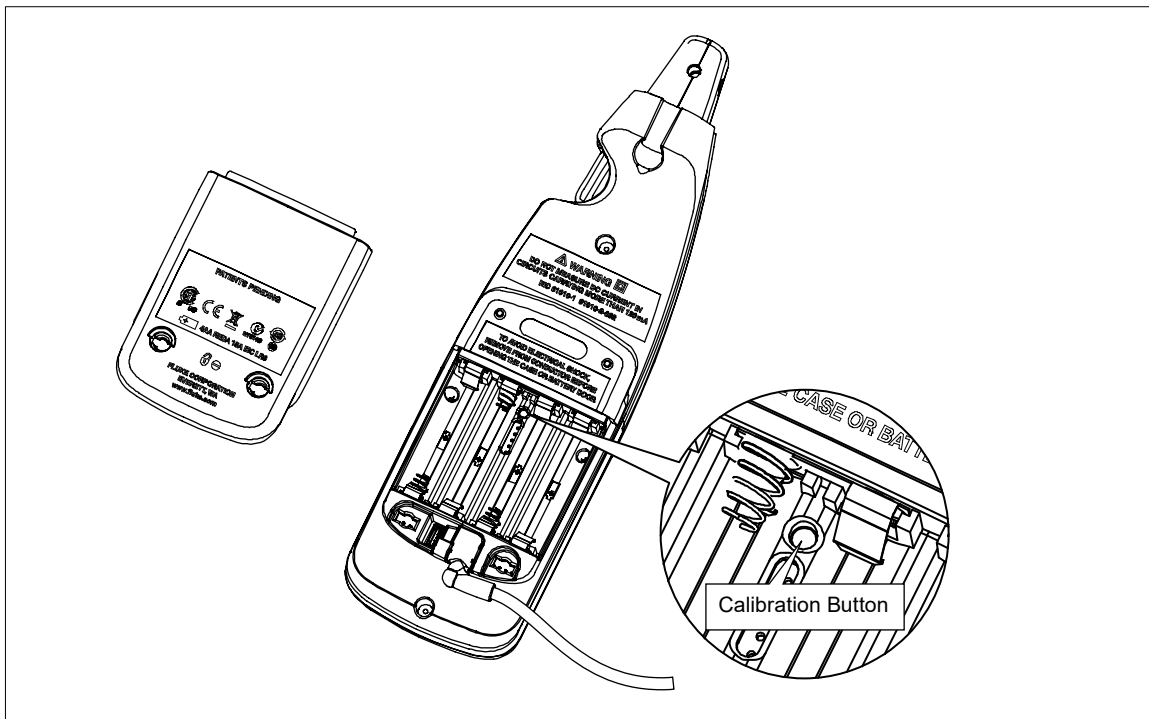

Figure 4. Accessing the Calibration Button

gep01.emf

There are five Meter functions to adjust:

1. Clamp measure
2. mA measure
3. Volt measure (773 only)
4. mA source
5. Volt source (773 only)

Table 3 shows the Meter buttons you use to select a function to be calibrated.

Table 3. Calibration Functions











Button	Calibration Function Description
	Engages mA function
	Identifies V dc function
	Identifies Clamp function
	Toggles between measure and source modes

Table 4 shows the Meter buttons you use to adjust the Meters calibration.

Table 4. Calibration Adjustments

Button	Calibration Adjustment Description
	A short button push (1 second) changes the Meter to the first calibration step A long button push exits the Meters calibration mode
 	Adjust source output in large steps
 	Adjust source output in small steps
	Forward to subsequent calibration step

The Meter display shows the value in each adjustment step.

- In Measure mode, the shown value is the calibrator input.
- In Source mode, the shown value is the Meter output.

To exit Calibration mode:

Push the calibration button a second time to keep new calibration constants and exit calibration mode.

Calibration Error Messages

The calibration error messages that the Meter can show are in Table 5. Steps to remove the messages are also shown in the table.

Table 5. Error Messages

Error Message	Cause of Error	Removal Steps
Cal	Meter not calibrated, use default parameter	Do all adjustments
Err	Code area checksum error	Meter repair is necessary

mA DC Clamp Measure Adjustment Procedure

To adjust the Clamp Measure function, use the Calibrator to apply the necessary Meter input and do the steps in Table 6.

Table 6. Clamp Measure Adjustment Procedure

Step	Meter Display	Calibrator Output	Procedure
1	0.00 mA	0.00 mA	Stop for 10 seconds, push HOLD
2	-20.00mA	-20.00 mA	Push HOLD
3	0.00mA	0.00 mA	Stop for 10 seconds, push HOLD
4	20.00mA	20.00 mA	Push HOLD
5	0.00 mA	0.00 mA	Stop for 10 seconds, push HOLD
6	-100.00mA	-100.00 mA	Push HOLD
7	0.00mA	0.00 mA	Stop for 10 seconds, push HOLD
8	10.00mA	100.00 mA	Push HOLD
9	Save	--	Push HOLD

mA DC Measure Adjustment Procedure

To adjust the mA Measure function, use the Calibrator to apply the necessary Meter input and do the steps in Table 7.

Table 7. mA Measure Adjustment Procedure

Step	Meter Display	Calibrator Output	Procedure
1	-20.00 mA	-20.00 mA	Push HOLD
2	0.00 mA	0.00 mA	Push HOLD
3	20.00 mA	20.00 mA	Push HOLD
4	Save	--	Push HOLD

Volts DC Measure Adjustment Procedure

To adjust the Volt Measure function, use the Calibrator to apply the necessary Meter input and do the steps in Table 8.

Table 8. Volt Measure Adjustment Procedure

Step	Meter Display	Calibrator Output	Procedure
1	-30.00V	-30.00 V	Push HOLD
2	0.00V	0.00 V	Push HOLD
3	30.00V	30.00 V	Push HOLD
4	Save	--	Push HOLD

mA DC Source Adjust Procedure

To adjust the mA Source function, use the Calibrator to apply the necessary Meter input and do the steps in Table 9.

Table 9. mA Source Adjustment Procedure

Step	Meter LCD display	Action
1	4.00 mA	Adjust until Meter output is 4.00 mA, push HOLD
2	20.00 mA	Adjust until Meter output is 20.00 mA, push HOLD
4	Save	Push HOLD

Volts DC Source Adjust Procedure (773 Only)

To adjust the Volt Source function, use the Calibrator to apply the necessary Meter input and do the steps in Table 10.

Table 10. Volt Source Adjustment Procedure

Step	Meter LCD display	Action
1	0.00 V	Adjust until Meter output is 0.00 V, push HOLD
2	10.00 V	Adjust until Meter output is 10.00 V, push HOLD
4	Save	Push HOLD

Replaceable Parts

Table 11 is a list of replaceable parts.

Table 11. Replaceable Parts

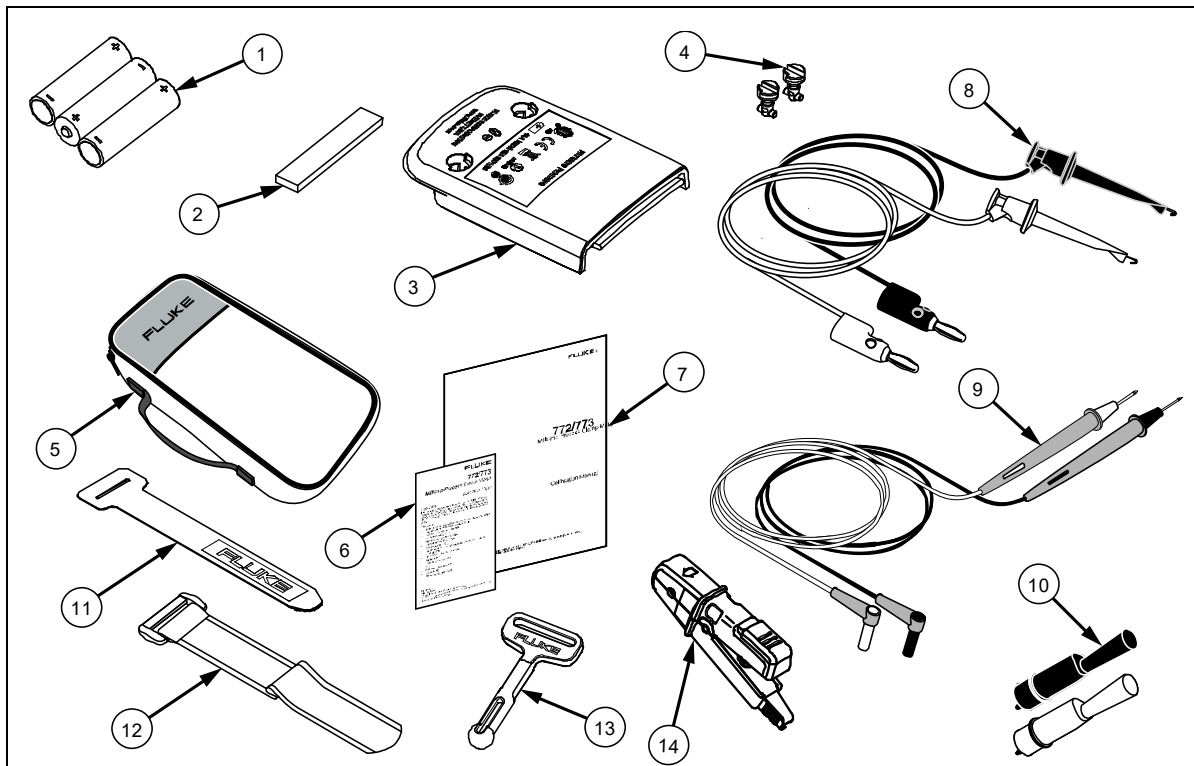



Item	Description	Quantity	Part or Model Number
①	AA Batteries, 1.5 V	4	376756
②	Absorber	1	3369914
③	Battery Door	1	3350978
④	Fastener	2	948609
⑤	Soft Carrying Case	1	3351060
⑥	Instruction Sheet	1	
⑦	Calibration Manual	1	
⑧	TL940 Mini Hook with Test Lead	1 Set	1616705
⑨	TL75- Test Leads	1 Set	855742
⑩	AC175 Alligator Clips	1 Set	4101772
⑪	Hook and Loop Strip	1	3031302
⑫	TPAK, Strap 17 inches	1	669967
⑬	Hanger	1	3375746
⑭	*Jaw Assembly	1 Set	3350957

*Re-calibration is required after jaw assembly is replaced.

FLUKE®

ir3000 FC BLE-IR Adapter

Quick Reference Guide

Symbol	Definition
CE	Conforms to European Union directives
	Conforms to relevant Australian EMC requirements
	This product complies with the WEEE Directive (2002/96/EC) marking requirements. The affixed label indicates that you must not discard this electrical/electronic product in domestic household waste. Product Category: With reference to the equipment types in the WEEE Directive Annex I, this product is classed as category 9 "Monitoring and Control Instrumentation" product. Do not dispose of this product as unsorted municipal waste. Go to Fluke's website for recycling information.

LIMITED WARRANTY AND LIMITATION OF LIABILITY

This Fluke product will be free from defects in material and workmanship for three years from the date of purchase. This warranty does not cover fuses, disposable batteries, or damage from accident, neglect, misuse, alteration, contamination, or abnormal conditions of operation or handling. Resellers are not authorized to extend any other warranty on Fluke's behalf. To obtain service during the warranty period, contact your nearest Fluke authorized service center to obtain return authorization information, then send the product to that Service Center with a description of the problem.

THIS WARRANTY IS YOUR ONLY REMEDY. NO OTHER WARRANTIES, SUCH AS FITNESS FOR A PARTICULAR PURPOSE, ARE EXPRESSED OR IMPLIED. FLUKE IS NOT LIABLE FOR ANY SPECIAL, INDIRECT, INCIDENTAL OR CONSEQUENTIAL DAMAGES OR LOSSES, ARISING FROM ANY CAUSE OR THEORY. Since some states or countries do not allow the exclusion or limitation of an implied warranty or of incidental or consequential damages, this limitation of liability may not apply to you.

Fluke Corporation
P.O. Box 9090
Everett, WA 98206-9090
U.S.A.

Fluke Europe B.V.
P.O. Box 1186
5602 BD Eindhoven
The Netherlands

11/99

ON / OFF



>2 s Off
Green - On
Red - Battery Low

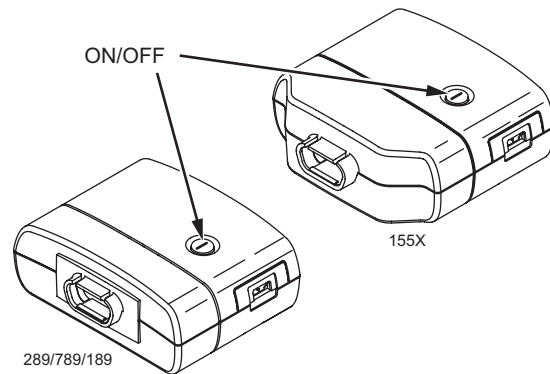

PN 4484206 May 2014
© 2014 Fluke Corporation. All rights reserved.

155X

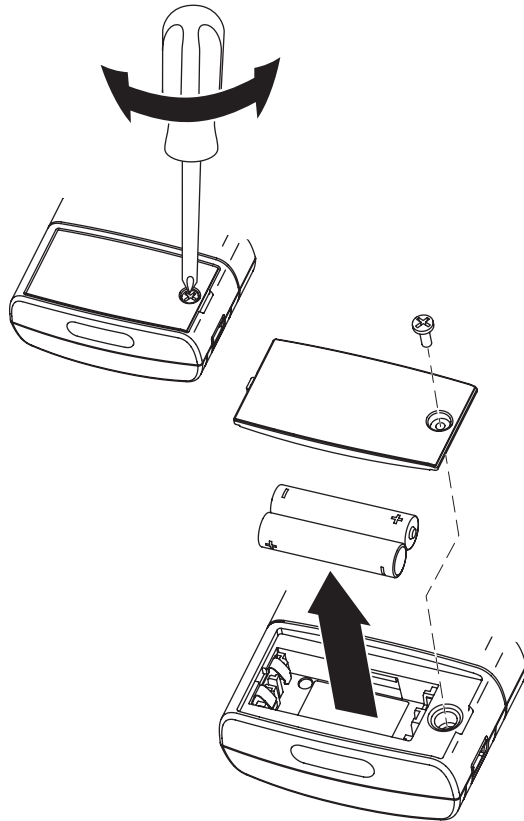
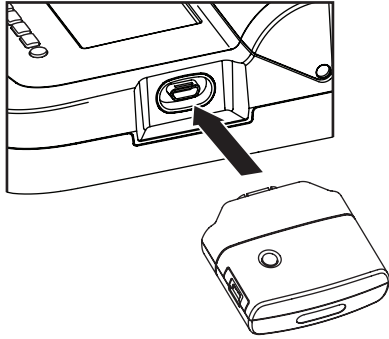

289

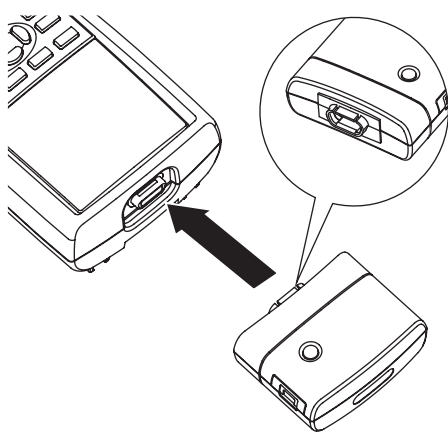

789/189

