

# Laser Shaft Alignment

**831**

- On-board Help (Users Manual)

## **Legal notices**

© 2022 Fluke. All rights reserved

Information in this document is subject to change without notice. The software described in this document is distributed under a license agreement. The software may be copied only in accordance with the terms contained in this agreement. This document or parts thereof may not be reprinted or reproduced in any form without written permission of Fluke.

Fluke products are the subject of patents granted and pending throughout the world. Contents are subject to change without further notice, particularly in the interest of further technical development. Reproduction, in any form whatsoever, only upon express written consent of Fluke

# Contents

---

<b>Contents</b> .....	<b>3</b>
<b>Introduction</b> .....	<b>7</b>
How to use the on-board help .....	7
Documentation .....	8
<b>Components</b> .....	<b>9</b>
Rugged device .....	9
Device interface .....	11
How to charge the battery .....	12
<b>sensALIGN 3 sensor and reflector</b> .....	<b>13</b>
sensALIGN 3 sensor .....	13
Sensor LEDs .....	14
Charging the sensor .....	14
Reflector .....	15
Sensor and reflector labelling .....	16
<b>Home screen</b> .....	<b>17</b>
<b>Configuration</b> .....	<b>18</b>
<b>Built-in camera</b> .....	<b>22</b>
Gallery .....	22
<b>RFID</b> .....	<b>24</b>
Assign a saved asset to an RFID tag .....	24
Open an asset measurement assigned to an RFID tag .....	25
<b>Cloud drive</b> .....	<b>27</b>
Transfer an asset to the Cloud drive .....	27
Download an asset from Cloud drive .....	27
<b>Mount components</b> .....	<b>28</b>
Mount brackets .....	28
Mount sensor and reflector .....	29
Mount sensor .....	29

Mount reflector .....	29
<b>Dimensions .....</b>	<b>32</b>
Train setup and fixation .....	33
<b>Machine properties .....</b>	<b>35</b>
Toggle .....	35
Machine color .....	35
Thermal growth .....	36
Thermal growth calculator .....	37
Multiple feet .....	39
<b>Coupling properties .....</b>	<b>41</b>
Targets .....	41
<b>Tolerances .....</b>	<b>43</b>
Available tolerance tables .....	43
ANSI standard specification tolerances .....	44
User defined tolerances .....	44
Asymmetric and symmetric tolerances .....	45
Tolerance table based on coupling format .....	45
Suggested consolidated shaft alignment tolerances .....	46
<b>Laser beam adjustment (sensALIGN 3) .....</b>	<b>49</b>
Adjust sensor and reflector until the laser beam status LED blinks green .....	49
<b>Laser beam adjustment .....</b>	<b>51</b>
Laser adjustment wizard .....	51
<b>XY View .....</b>	<b>53</b>
<b>Initialize sensor .....</b>	<b>55</b>
<b>Measurement .....</b>	<b>56</b>
Averaging .....	56
<b>Measurement modes .....</b>	<b>58</b>
<b>Active Clock measurement .....</b>	<b>59</b>
Taking measurement points automatically .....	61



<b>Static measurement</b> .....	<b>63</b>
<b>Extend measurement range manually</b> .....	<b>65</b>
<b>Measurement table</b> .....	<b>67</b>
Measurement quality .....	68
<b>Edit measurement data</b> .....	<b>70</b>
Broken ellipse .....	70
What is the effect of deactivating individual points? .....	71
<b>Results</b> .....	<b>72</b>
Results options .....	74
Sign convention .....	74
<b>Multiple feet results</b> .....	<b>76</b>
Foot corrections .....	76
<b>Live Move screen</b> .....	<b>78</b>
<b>Save asset measurements</b> .....	<b>82</b>
Save an asset .....	82
Asset list options .....	83
Default template .....	87
<b>Generate reports</b> .....	<b>89</b>
Generate measurement reports .....	89
Report logo .....	90
<b>Save report to USB drive</b> .....	<b>92</b>
<b>What is soft foot</b> .....	<b>94</b>
Parallel soft foot .....	94
Angular soft foot .....	94
Checking and correcting soft foot conditions .....	95
<b>Soft foot</b> .....	<b>96</b>
Sensor measurement .....	96
Manual entry .....	98

<b>Vertical flanged machines</b> .....	<b>99</b>
Mark measurement positions .....	99
Set-up .....	101
<b>Vertical flanged machines – Static clock</b> .....	<b>103</b>
Use Static measurement mode .....	103
<b>Vertical results</b> .....	<b>105</b>
Shimming modes .....	105
Sign convention .....	105
<b>Live Move – Vertical machines</b> .....	<b>107</b>
Correct angularity .....	107
Correct offset .....	107
<b>sensALIGN 3 sensor firmware update</b> .....	<b>111</b>
Update sensor firmware to a newer version .....	111
Notification on sensor calibration .....	113
<b>Best practice</b> .....	<b>116</b>
Mounting sensor and reflector .....	116
Entering dimensions .....	116
Initializing sensor .....	116
Causes that may influence measurement .....	117
Results and Live Move .....	117
<b>Appendix</b> .....	<b>118</b>
Update Fluke 831 to a newer firmware version .....	118
Documentation .....	120
<b>Technical data – Rugged touch device</b> .....	<b>121</b>
<b>Technical data – sensALIGN 3 sensor</b> .....	<b>122</b>
<b>Technical data – Reflector (prism)</b> .....	<b>123</b>
<b>Index</b> .....	<b>124</b>

## Introduction





This on-board help provides information to support users of Fluke 831.

### How to use the on-board help

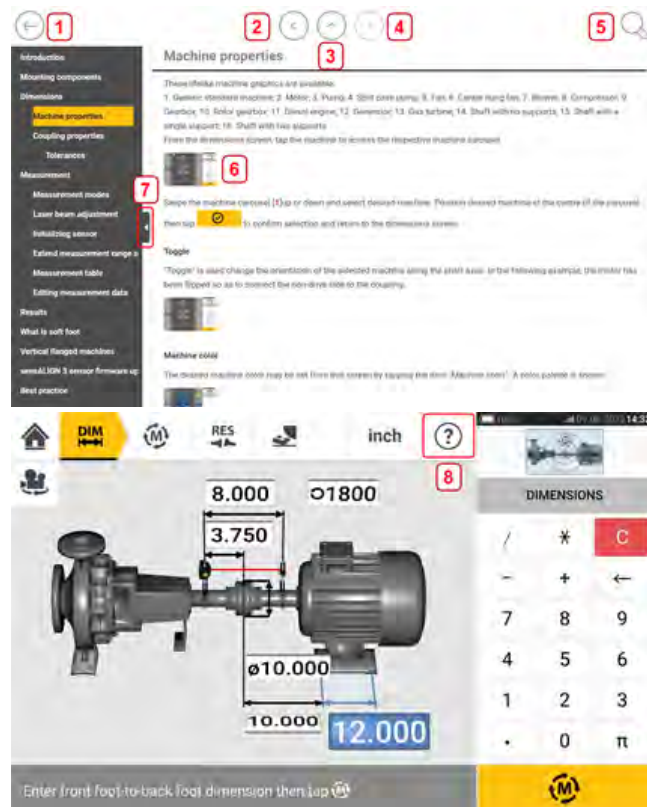
The on-board help is accessed through the home screen. Tap  the "Home" icon then the question mark icon  to access the on-board help.

Context sensitive help can be accessed from specific screens. Tap the question mark icon  provided on the specific screen.



- **(1)** Tap  to return to the start screen.
- **(2)** Tap  to go back.
- **(3)** Tap  to go to this on-board help start page.
- **(4)** Tap  to go forward.
- **(5)** Tap  to search for text in the on-board help. A search field together with an onscreen keyboard appears.
- **(6)** Throughout this on-board help, image thumbnails have been used. Tap the image thumbnail to enlarge the image.  
To zoom out and proceed, tap the enlarged image.
- **(7)** The navigation pane hide arrow is used to hide the navigation menu items. Tap the

arrow to hide or show the navigation menu items.

- **(8)** This screen-specific help icon is used to access the context sensitive help.



**Note**

It is recommended to scroll to the bottom of the page to be able to access other related topics which are frequently used throughout the on-board help.

## Documentation



**Note**

This on-board help and other relevant and related customer documents are saved as PDF files in the folder "Manuals" within the rugged device. To access this folder, the rugged device is connected to a Windows PC. Allow the Windows PC to access the rugged device and then double-click "Tablet" to access the required folder.

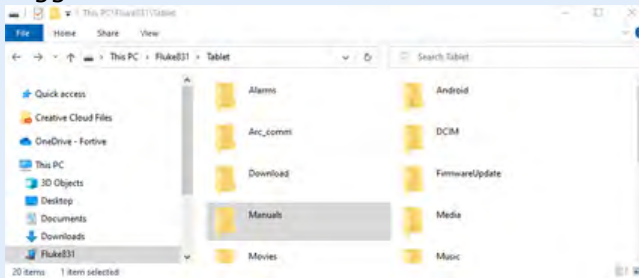



## Components

The main components used to measure shaft alignment are the rugged device, the sensor and the reflector.

### Rugged device





- **(1)** Power key – used to switch the rugged device on. Press and hold down the power key until the device turns on.
- **(2)** Front camera
- **(3)** Ambient light sensor
- **(4)** Volume down button (refer to **Note** below)
- **(5)** Strap (on either side of the device)
- **(6)** Rear camera
- **(7)** LED flash
- **(8)** Foldable stand – used to hang device from a railing or lay it down in perfect viewing position
- **(9)** Location of Near Field Communication (NFC) antenna
- **(10)** Protective bumper
- **(11)** USB type C multipurpose connector – used to charge the rugged device or connect the tablet to auxiliary equipment such as a PC
- **(12)** Magnetic strap – used to hang device on any magnetic surfaces



**Note**

The only application that runs on this rugged device is Shaft Alignment. The application runs in only landscape mode. Additional apps cannot be installed in this dedicated device.

To capture screenshots on the device, press keys **1** and **4** simultaneously.

If the device freezes or is unresponsive, press and hold keys **1** and **4** simultaneously for more than 7 seconds to restart device.

To turn the rugged device, press and hold down the power key [**1**]. To operate the device, tap and swipe the touchscreen.

To turn the device off, press and hold down the power key [**1**]. Two hints appear on the display.

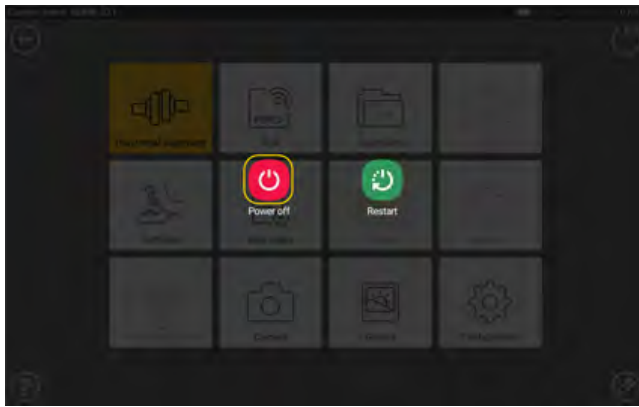

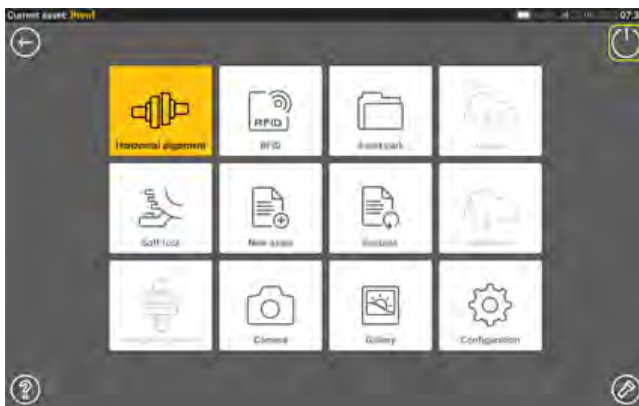

Tap the "Power off" icon to switch the rugged device off.

To stop the Shaft application and switch the device to sleep mode, tap the power-off icon [  ] shown on the home screen.

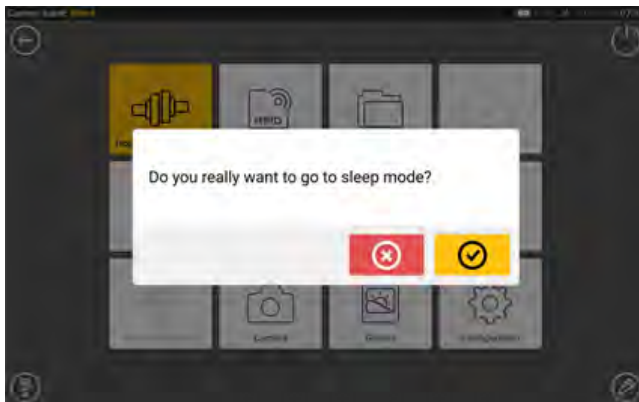

A hint that requires confirmation to go to sleep mode appears on the display.



Tap  to confirm selection.

## Device interface



The multipurpose connector [ **11** ] is used to charge the device and for connection to a PC. When connected to a PC, data can be transferred from the device or firmware update can be performed.

## How to charge the battery

Charge the battery before the rugged device is used for the first time or when the device has not been used for extended periods.  
Use only the supplied charger and the related USB C to USB A cable.



- Connect the standard USB A end ( **1** ) to the supplied USB charger.
- Plug the USB C end ( **2** ) to the rugged device's multipurpose connector.
- Connect the USB charger to mains supply.
- After fully charged, disconnect the charger from the rugged device, and then unplug the charger from the mains supply.

The charge capacity is shown by the power icon ( **1** ) on the top right corner of the display.

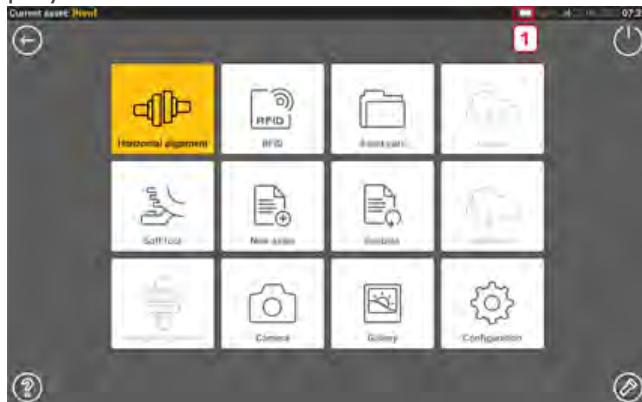

## sensALIGN 3 sensor and reflector

### sensALIGN 3 sensor

The sensor has an integrated Bluetooth, and contains a position detector, which measures the position of the laser beam as the shafts are rotated. The sensor also contains an electronic inclinometer for shaft rotation measurements. The semiconductor laser diode within the sensor emits a ray of red light (wavelength 630 – 680 nm) which is visible at the point it strikes a surface. The Class 2 laser beam is emitted with a diameter of approx. 5 mm (3/16”).



The sensor has two indicator LEDs on its front side. When facing the sensor, the left LED shows both the laser beam adjustment and charging statuses. The LED lights red, orange or green depending on current function. The LED on the right shows the Bluetooth communication status and lights blue when scanning and when communication is established.

The sensor is water and dust resistant (IP 65). The internal optics and electronics are internally sealed, preventing possible contamination.

The sensor is powered using its internal 3.7 V 5 Wh Lithium-ion rechargeable battery.

The sensor is turned on by pressing its On/Off switch. The red LED lights when sensor is switched on.

The sensor is turned off by pressing and holding briefly its On/Off switch until both LEDs are off.



#### WARNING

When the sensor is switched on, the laser beam is emitted. DO NOT stare into the laser beam!

The following illustrations shows both the front and back sides of the sensor.

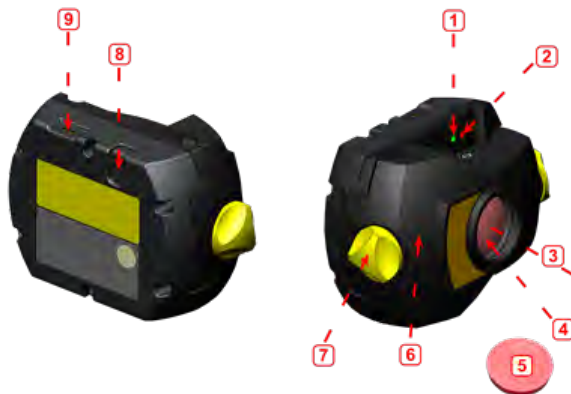

**1:** Laser beam status and charging LED; **2:** Laser on/Bluetooth communication LED; **3:** Laser beam; **4:** Scratch resistant lens; **5:** Sensor dust cap; **6:** IP 65 housing; **7:** Locking knob; **8:** On/Off switch; **9:** Micro USB port



#### CAUTION

Under no circumstances may the six housing torx head screws be removed, as that would void all warranty coverage.

## Sensor LEDs

Activity	Laser beam status and charging LED	Laser on / Bluetooth communication LED
Switch on	Lights up red for 1 second, then red or green (depending on the battery capacity) for another second, then continues to blink red	Lights up blue for 1 second then continues to blink red (indicating laser emission)
Laser beam status	Blinks red when laser is OFF Blinks orange when laser is in END position Blinks green when laser centered or in 'laser OK' position	When Bluetooth communication is established blinks blue once then red three times (indicating laser emission). This sequence repeats itself
Charging	Blinks fast green during fast charge (0% - 90%) Blinks slowly green when charge is > 90% Lights steady green when charge is 100%	

## Charging the sensor

The sensor may be charged using mains supply or a PC.



### Note

Charging the sensor using mains supply is faster than when charging through a PC.

The supplied micro USB is used to connect the charging source to the sensor.



## Reflector

The reflector is always mounted on the shaft or solid coupling of the machine to be moved. It reflects the laser beam back into the position detector as the shafts are rotated. The locking lever flips into the horizontal position, facing forward, to hold the reflector in place on the bracket posts. The reflector is adjusted by changing its vertical position and its horizontal angle (using the thumbscrews) so that the beam is reflected directly back into the sensALIGN 3 sensor.

The reflector must be kept clean. Use the provided lens cleaning cloth or a fine dusting brush such as that normally used to clean other optical devices.

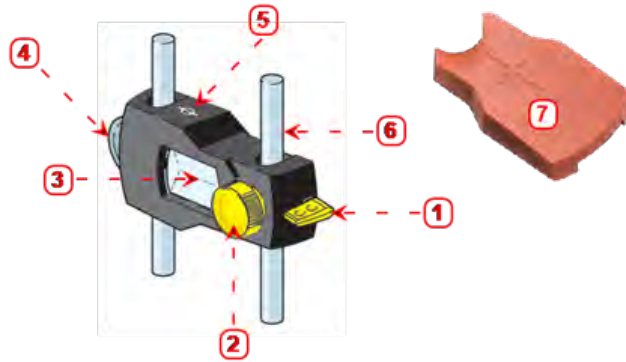

**1:** Quick release lever; **2:** Horizontal angle adjustment knob; **3:** 90° roof prism; **4:** Vertical position adjustment thumbwheel; **5:** Measure mark = center of posts; **6:** Support post (not part of reflector); **7:** Reflector dust cap



**CAUTION**  
 Avoid vigorous polishing to preserve the anti-reflective coating. Keep the dust cap on the reflector when it is not in use.

### Sensor and reflector labelling

Labels used in communicating laser safety and other general information are to be found affixed to the housing of the system components.

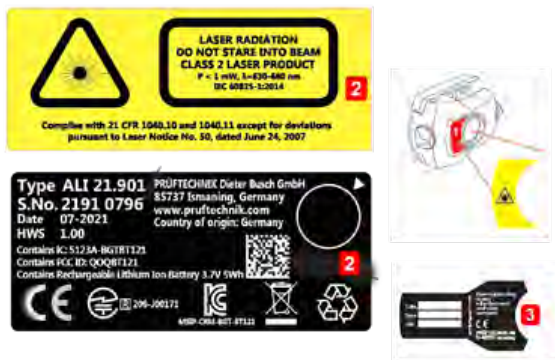

- **(1)** The laser safety warning symbol label is affixed on the front of the sensor.
- **(2)** On the back of the sensALIGN 3 sensor is an amalgamation of three labels. The top label shows the laser safety warning. The lower label contains the sensor identification, related certification, and disposal information. The round calibration check label shows the calibration check due date; the black arrow points to the month when the calibration check is due. The year appears in center of the label.
- **(3)** The label affixed on the back of the reflector



## Home screen

The home screen is displayed when the device is switched on. Within the application, tap the "Home" icon to open the home screen. 



Tap the respective icon to start the related function:

- **(1)** The "Horizontal alignment" icon is used to start the horizontal alignment application.
- **(2)** The "Soft foot" icon is used to start soft foot measurement.
- **(3)** The "Vertical alignment" icon is used to start the vertical alignment application. If this icon is inactive, tap the "New asset" icon **(5)** to activate the vertical alignment icon.
- **(4)** The "RFID" icon is used to open assets assigned to related RFID tags.
- **(5)** The "New asset" icon is used to start a new asset (this may be a pump-motor combination).



### Note

For any opened asset, different applications that may include shaft alignment and soft foot measurement, can be performed.

- **(6)** The "Camera" icon is used to access the built-in camera.
- **(7)** The "Asset park" icon is used to display all saved assets and templates.
- **(8)** The "Resume" icon is used to resume last asset opened (provided it was saved) when the device is switched on.
- **(9)** The "Gallery" icon is used to display all images taken within the Shaft application.
- **(10)** The "Upload" icon is used to save asset measurements in the Cloud drive.
- **(11)** The "Download" icon is used to open asset measurements from the Cloud drive.
- **(12)** The "Configuration" icon is used to configure the Shaft application settings (which include language, date, time, default settings), and access its built-in mobile connectivity. Mobile connectivity enables the device to access the Cloud functionality that allows wireless file sharing.
- **(13)** The "Back" icon is used to return to previous screen.
- **(14)** The "Power-off" icon is used to send the rugged device into sleep mode.
- **(15)** The "Flashlight" icon is used to turn the rugged device's LED flash on/off.
- **(16)** The "Help" icon is used to access the on-board help file.

## Configuration

From the home screen, tap  the configuration icon to access these configuration items:

- "System settings" sets these items:

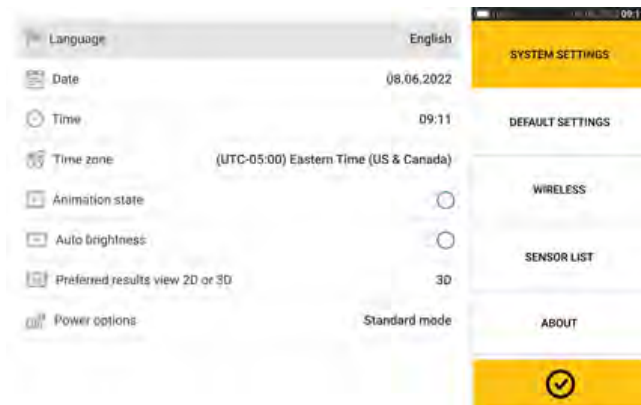

> Language (system language); > Date; > Time; > Time zone;

> Animation state — regulates the transition between the dimension, measure and results screens. Options available: fast and standard. If "Animation state" is on, the transition between screens is set to standard and therefore noticeable. If off, the transition is fast.

> Auto brightness — adjusts the display brightness of the touch device. If "Auto brightness" is on, the display brightness adjusts automatically. If off, then the display brightness is adjusted manually. Drag the brightness slider to the left (decreases brightness) or right (increases brightness).

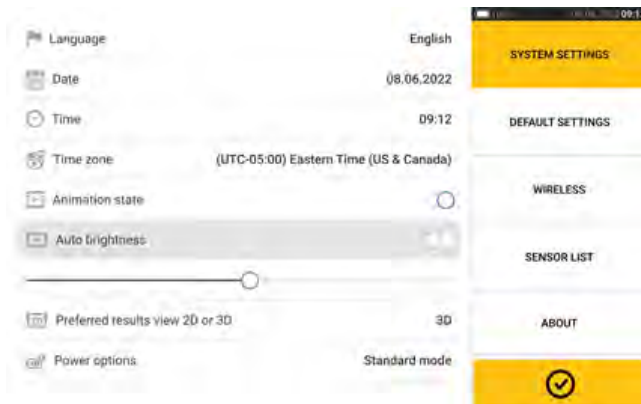

> Preferred results view 2D or 3D

> Power options — used to manage the power usage in the touch device. The power modes available are: "Standard" (the display dims after 10 minutes and goes to sleep mode after 20 minutes), "Maximum" (no dim and no sleep mode), "Presentation" (the display dims after 1 hour, but never enters the sleep mode) and "Minimum" (the display dims after 3 minutes and goes to sleep mode after 5 minutes). To get out of the sleep mode, press the power key.

- "Default settings" is used to set units of length, angle and temperature; the default diameter is set here. The item is also used to set the number of Active Clock measurement points required to obtain results. 3 – 5 points may be set. Although a minimum of 3 measurement points are required for results, it is recommended to take the maximum number of points available.

Other items set under "Default settings" include: To take points automatically after

stabilization and default tolerance type.

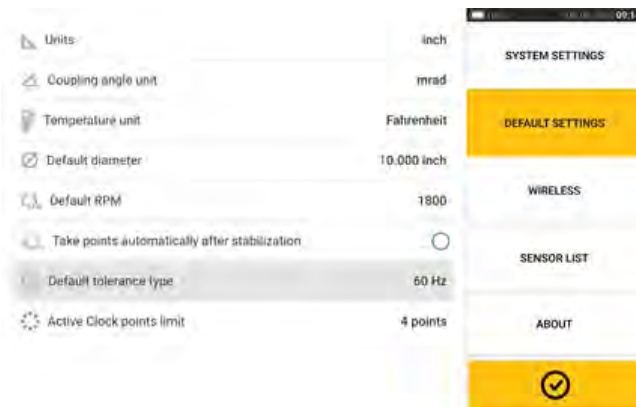

### Note

When metric units are used, the resolution of physical quantities used within the device can be set to two (0.01 mm) or three (0.001 mm) decimal places. This measurement precision is available in "Measurement", "Results" and "Live Move" screens. The "Dimensions" screen uses only positive integers.

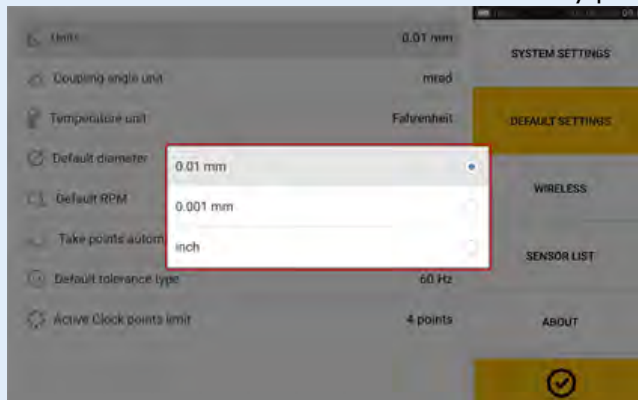

The set time zone is connected to the default RPM unless the default RPM is edited independently. When the time zone is set to say "Central America" the default RPM is 1800. When the "London" time zone is set, the default RPM is 1500.

- When activated, "Wireless connection" is used to connect the rugged device to available WiFi networks.

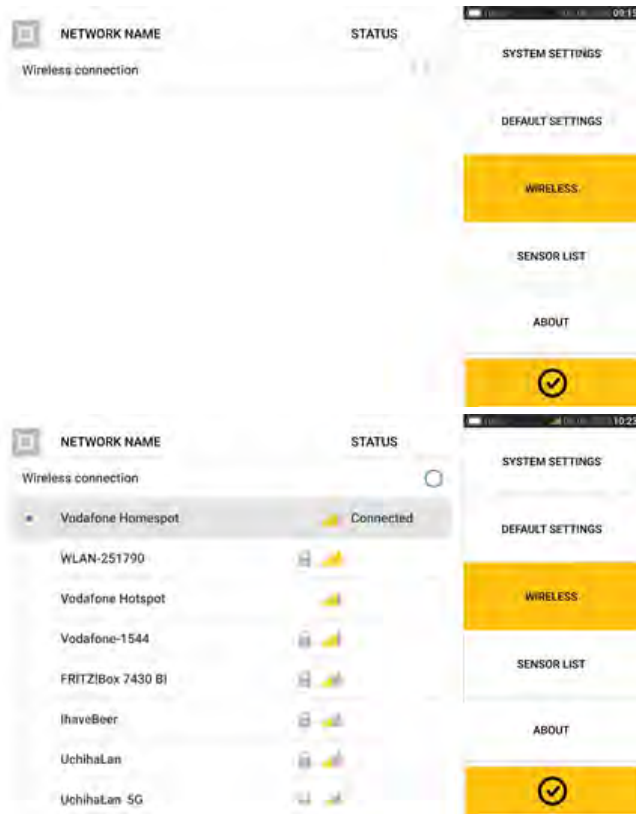

**Note**

The rugged device may be connected only to WiFi networks that do not open separate web browsers to login.

- Sensor list displays all available sensors.



- The "About" screen displays the device serial number, firmware version of the application and available memory space.  
Tap "Licences" (1) to access the applicable GNU General Public License information.



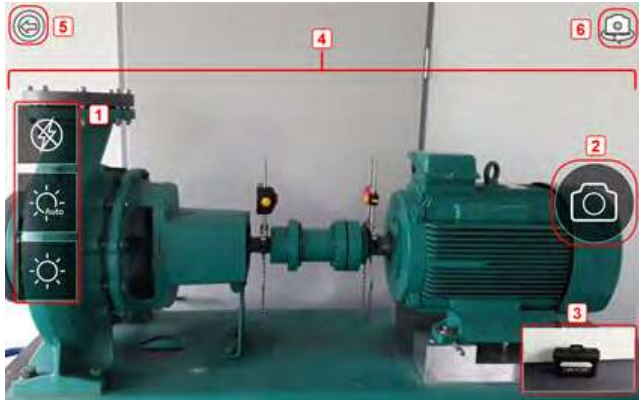

## Built-in camera

From the home screen, tap  the 'Camera' icon to access the function.



Focus the device on the object to be photographed. The object is displayed on the screen.

- **(1)** Camera settings for indoor, outdoor and night imaging, including automatic light setting – Tap desired light setting icon (Flash may be turned on/off; Auto mode is for automatic light setting).
- **(2)** Tap  the "Take picture" icon to take a photo of the object focused on the display.
- **(3)** Tap this location to access the device gallery. All images taken using the touch device are saved at this location.
- **(4)** Object to be photographed
- **(5)** Tap  to return to home screen.
- **(6)** Tap  to switch between the front- and rear-facing cameras.

## Gallery

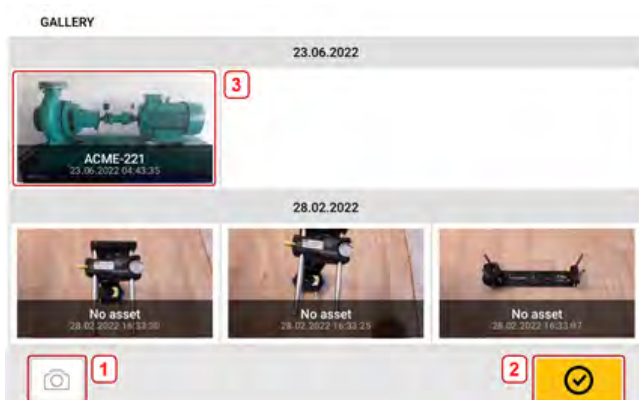

To view all images saved in the gallery, touch then drag up or down. All images are displayed as miniatures.

- **(1)** Tapping  returns user to the image settings screen where objects may be photographed.

- **(2)** Tapping  opens the home screen.
- **(3)** Tap any miniature to view the image in full scale.

Images may be deleted from the gallery by tapping the desired image. This appears in full scale and may then be deleted by tapping the trash icon **(1)**.



The images in the gallery may be scrolled by using the arrow icons **2/3**.

**Note**

Images saved to the gallery may only be transferred to a PC if assigned to an asset. Before taking the desired photo or screenshot the corresponding new or existing asset must be opened. The captured image may then be transferred to the PC software ARC 4.0.

## RFID

The rugged device uses this automatic identification technology to do these:

- Identify assets to be aligned
- Enter related assets directly into the device
- Store data and results under the correct asset automatically

### Assign a saved asset to an RFID tag

From the home screen, tap  the "Asset park" icon to show assets saved.

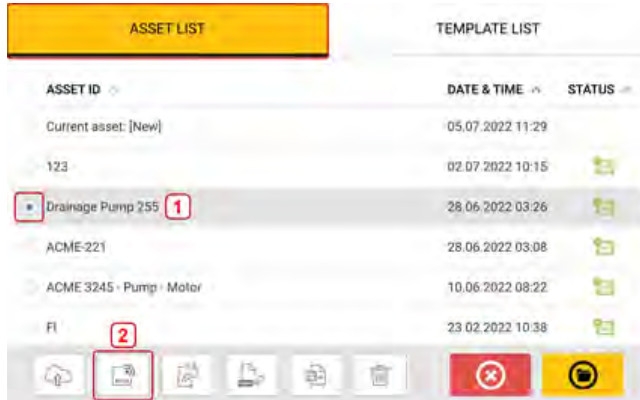

Tap the asset [1] that is to be assigned to the RFID tag, then tap the RFID icon [2].



Position the rugged device such that its built-in NFC antenna is as close to the RFID tag as possible (less than a centimeter).



- **(1)** Near Field Communication (NFC) antenna symbol

As soon as data has been written on the RFID tag, the related hint is shown.





Tap  to exit the screen.



### Note

If however, data had already been assigned to the RFID tag, a hint to overwrite the data is shown.

## Open an asset measurement assigned to an RFID tag

From the home screen, tap  the "RFID" icon.



Position the rugged device such that its built-in NFC antenna is as close to the RFID tag as possible (less than a centimeter).

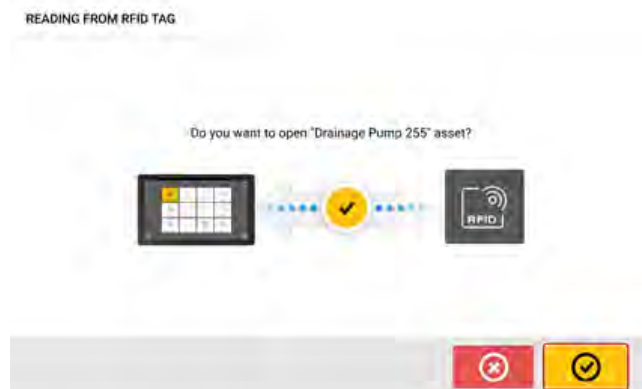

Tap  to open the asset measurement.

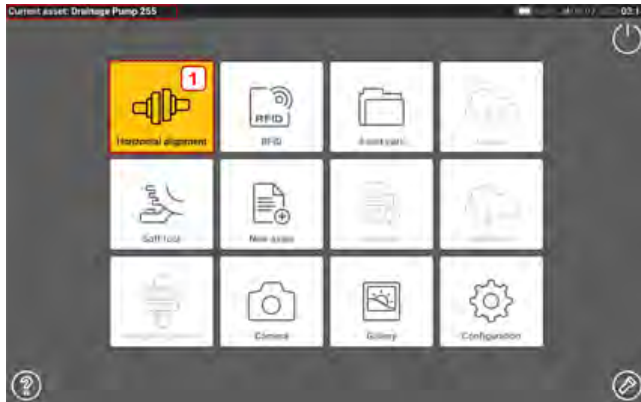

The asset name is displayed on the home screen. Tap the shaft alignment icon [1] to start the application.



**Note**

If however, no data had been written on the RFID tag, a hint on missing information appears.

## Cloud drive

To set up the Cloud drive, an ALIGNMENT RELIABILITY CENTER 4.0 (ARC 4.0) licence is required. The Cloud drive allows up-to-date asset measurements from different devices to be shared through the PC software ARC 4.0.



### Note

Wireless connection between the rugged device and a network must be established to enable assets to be transferred through ARC 4.0.

### Transfer an asset to the Cloud drive

After measurement is finished, save the asset [1] then upload it to Cloud drive.

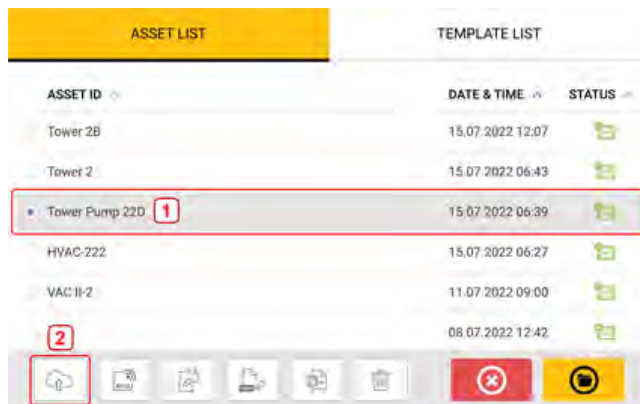

Tap the "Upload" icon [2]. The asset appears in ARC 4.0 "Exchange" view with the status "complete". Drag and drop the asset in its appropriate location on the Cloud drive.

### Download an asset from Cloud drive

From the ARC 4.0 "Exchange" view, drag and drop the desired asset into the Name pane. The asset appears with the status "ready".

From the touch device home screen, tap the "Download" icon . The selected asset appears in the asset park (1).

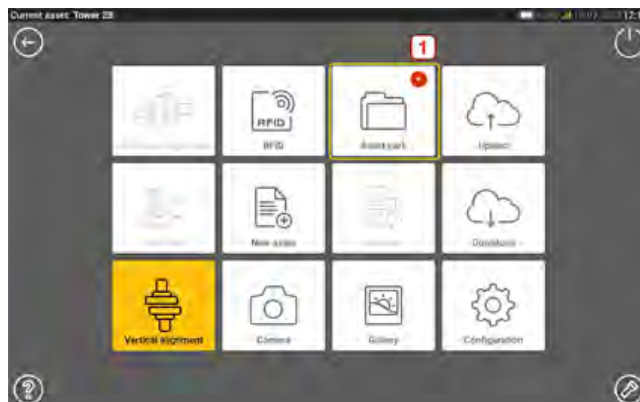

Tap the "Asset park" icon to open the asset in the rugged device.

## Mount components

### Mount brackets



#### Note

The system is delivered with fully assembled brackets with both the sensALIGN 3 sensor and the reflector already assembled. In this case, the bracket holding the sensor is mounted on the shaft on the left side of the couplings or the solid coupling hub on the left side (usually stationary machine). The bracket assembly holding the reflector is mounted on the shaft on the right side of the couplings or the solid coupling hub on the right side (usually moveable machine).

Mount the brackets on either side of the coupling on either the shafts or on the solid coupling hubs, and both at the same rotational position.

Please note the following in order to obtain the highest possible measurement accuracy and to avoid damage to equipment:



#### CAUTION

Ensure that the brackets fit solidly onto their mounting surfaces! Do not use self-constructed mounting brackets, or modify the original bracket configuration supplied by Fluke (for example, do not use support posts longer than those supplied with the bracket).

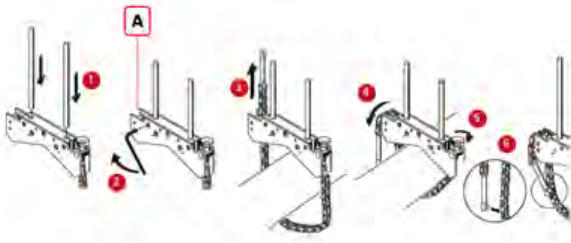

- **(A)** Anchor peg
  - Choose the shortest support posts which will still allow the laser beam to pass over or through the coupling. Insert the support posts into the bracket..
  - Fasten them in place by tightening the hex screws on the sides of the bracket frame.
  - Place the bracket on the shaft or coupling, wrap the chain around the shaft and feed it through the other side of the bracket: if the shaft is smaller than the width of the bracket frame, insert the chain from the inside of the bracket as shown in the diagram; if the shaft is larger than the bracket width, insert the chain into the frame from the outside.
  - Catch the chain loosely on the anchor peg **(A)**.
  - Turn the bracket thumbscrew to tighten the assembly onto the shaft.
  - Clip the loose end of the chain back onto itself.

The bracket should now be tight upon the shaft. Do not push or pull on the bracket to check, since this could loosen its mounting.

To remove the brackets, loosen the thumbscrew, then remove the chain from its anchor peg.

## Mount sensor and reflector

### Mount sensor

- Mount the sensor on the support posts of the bracket fixed on the shaft of the left machine (usually stationary machine) – as viewed from normal working position. Ensure that its yellow knobs are loosened enough to let you slide the housing onto the support posts. Note the orientation of the sensor. The micro USB port must be at the top.

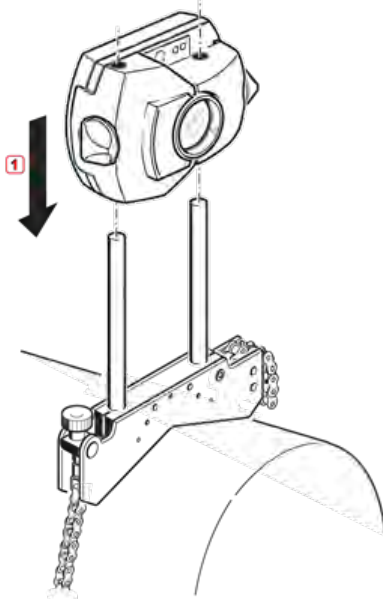

- Clamp the sensor onto the support posts by tightening the yellow knobs. Ensure that the laser beam can pass over or through the coupling and is not blocked. Take care not to overtighten the yellow locking knobs.

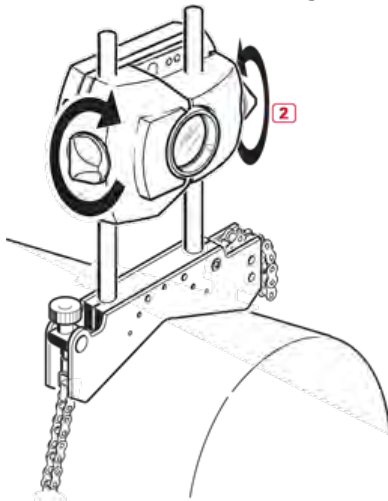

### Mount reflector

- Mount the reflector on the support posts of the bracket fixed on the shaft of the right machine (usually moveable machine) – as viewed from normal working position.

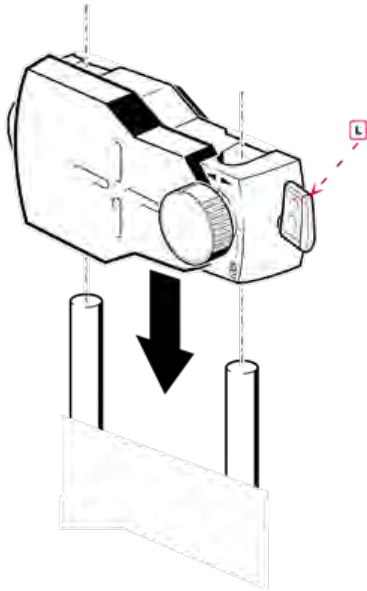

**(L)** Lever

The yellow knob on the front of the reflector allows you to adjust the horizontal angle of the reflected laser beam. Before you mount the reflector make sure that this knob is centered to allow for maximum adjustment range later on. The bottom of the knob should be flush with the arrow marking on the reflector housing.

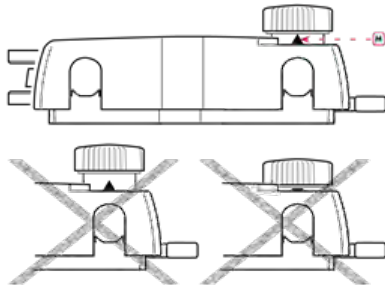

**(M)** Arrow marking

Match the height of the yellow knob approximately to the tip of the arrow

- Flip up the quick-release lever on the side of the reflector housing, then slide the reflector onto the right-hand bracket posts. Return the lever to its horizontal position to secure the reflector on the posts.

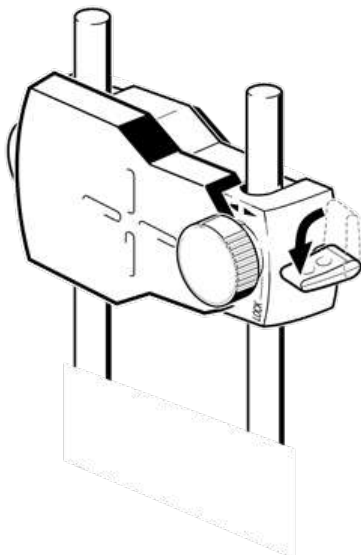

Both sensor and reflector should be at the same height, as low as possible, yet just high enough for the beam to clear the coupling flange. They should also visually appear to be rotationally aligned to each other.

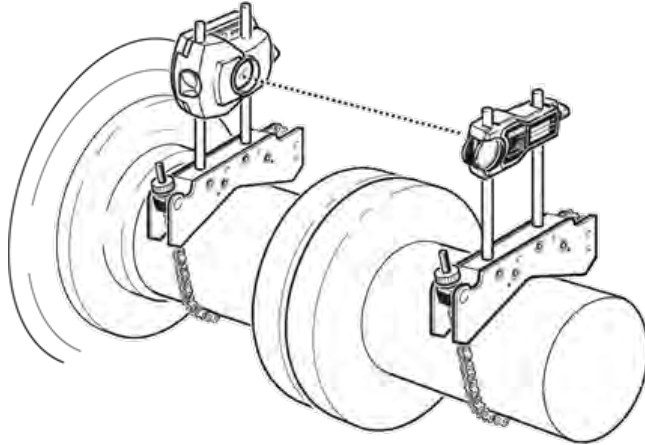

In some cases, if the coupling is large enough, a coupling bolt can be removed and the laser beam shot through the bolt hole.

Make the final adjustments, loosening the brackets slightly if necessary, then rotating them and re-tightening.

## Dimensions

From the home screen, tap  the horizontal alignment icon to access the dimensions screen.

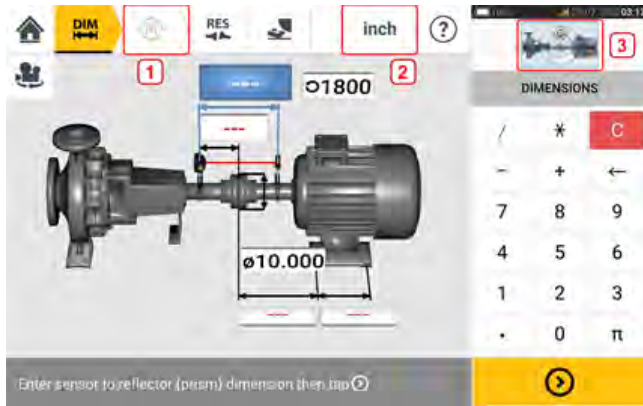

- **(1)** Grayed out icons are disabled within the active screen. The 'Measure' icon is enabled after all dimensions have been entered.
- **(2)** Tap the measurement units icon **inch** to set desired units. The icon toggles between "inch" and "mm".
- **(3)** Tap the slider on the mini train icon to open the triple "Train Manager" / "Train Setup" / "Train Fixation" screen.  
**Note:** "Train Manager" is not active. See section on train setup and fixation for details.

Tap the dimension fields and enter all required dimensions. The user may elect to tap  the 'Next' button to proceed to enter next dimension. Dimensions may be entered only when the dimension field is highlighted blue.



### Note

If units are set to Imperial system, inch fractions may be entered as follows: For  $\frac{1}{8}$ " enter  $1/8 = 0.125$ "; For  $10 \frac{3}{8}$ " enter  $10 + 3/8 = 10.375$ ".  
 The coupling diameter value may be determined by entering the measured circumference of the coupling and dividing the value by  $\pi$  (pi) (= 3.142). For example  $33"/\pi = 10.5$ "; Or  $330 \text{ mm}/\pi = 105 \text{ mm}$

The rotate machine view icon  is used to rotate the view of the machines and mounted components on the display.

Machine and coupling properties may be edited by tapping the respective machine or coupling.

When all required dimensions have been entered, the 'Measure' icon  comes into view.







Tap  to proceed with measurement.

## Train setup and fixation

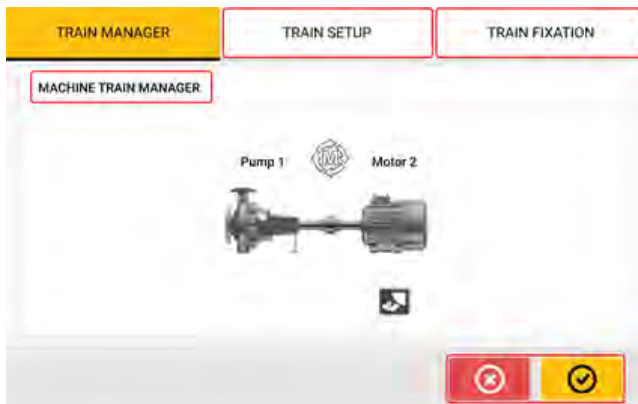
The mini train icon with slider is available in the dimensions, measure and results screens. Tap the slider to open the triple "Train Manager" / "Train Setup" / "Train Fixation" screen.





The machine train manager screen is not active.

Tap either TRAIN SETUP or TRAIN FIXATION to open related screen. Alternatively, tap either  or  to return to previous screen.

If TRAIN SETUP is selected, the machine train setup screen can be used to select necessary machine and coupling types. Machinery color can also be selected.



Tap machine or coupling to be specified. If a machine is selected, both machine and color carousels appear. If coupling is selected, only the coupling carousel appears. Use the carousels to specify machine or coupling type, and the machine color. Only one element can be specified at a time. After an element has been defined, tap

 the proceed to select the next element. When all machine train elements have been defined, tap  to return to the screen from where the triple "Train Manager" / "Train Setup" / "Train Fixation" screen was initially opened.

If TRAIN FIXATION is selected, the machine train fixation screen can be used to fix and unfix machine feet pairs or entire machine. This solves machine bolt-bound problems.



In this example, the pump has no feet [1] and is permanently fixed. The motor feet pairs [2] are unfixed and therefore movable. Tap  [3] to return to the screen from where the triple "Train Manager" / "Train Setup" / "Train Fixation" screen was initially opened.



To make a machine permanently fixed tap the symbol [1] at the center of the machine. To undo this action, tap the symbol [1] again. When a machine is unfixed feet are shown. To fix any machine feet pair tap the necessary feet pair. Fixed feet pairs are shown marked red [2].

If feet pair are redefined, then machine dimensions must be adjusted. Tap  to open the dimensions screen and enter necessary dimensions.

## Machine properties

These lifelike machine graphics are available:

1. Generic standard machine; 2. Motor; 3. Pump; 4. Split case pump; 5. Fan; 6. Center hung fan; 7. Blower; 8. Compressor; 9. Gearbox; 10. Rotor gearbox; 11. Diesel engine; 12. Generator; 13. Gas turbine; 14. Shaft with no supports; 15. Shaft with a single support; 16. Shaft with two supports

From the dimensions screen, tap the machine to access the respective machine carousel.

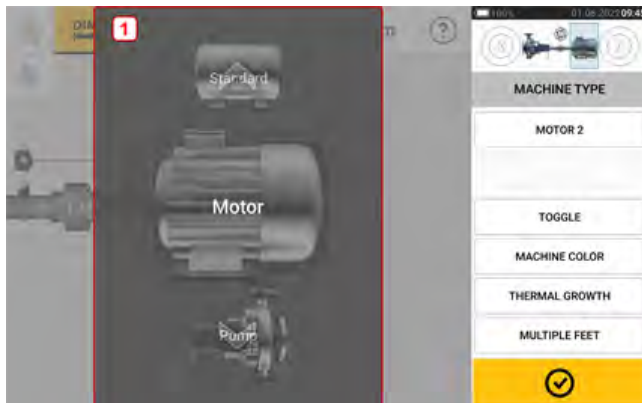

Swipe the machine carousel [1] up or down and select desired machine. Position desired machine at the centre of the carousel then tap  to confirm selection and return to the dimensions screen.

### Toggle

"Toggle" is used change the orientation of the selected machine along the shaft axes. In the following example, the motor has been flipped so as to connect the non-drive side to the coupling.

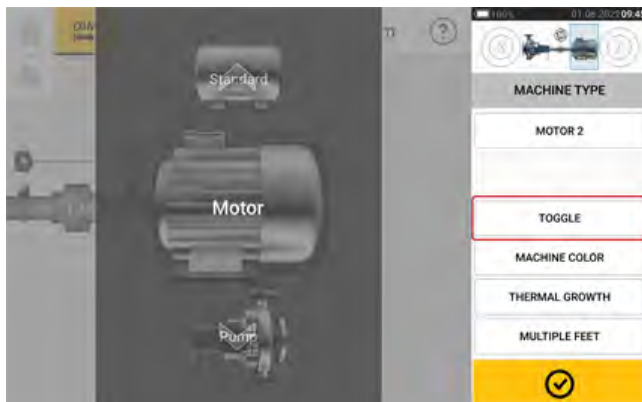

### Machine color

The desired machine color may be set from this screen by tapping the item "Machine color". A color palette is shown.

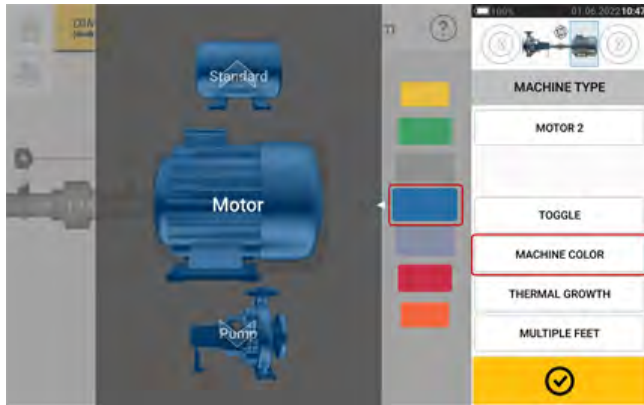

Swipe the color palette up or down to select the desired color then tap  to confirm selection and return to the dimensions with the machines having the desired color.

## Thermal growth

Thermal growth is the movement of shaft centerlines associated with or due to a change in machinery temperature between the idle and operating conditions.

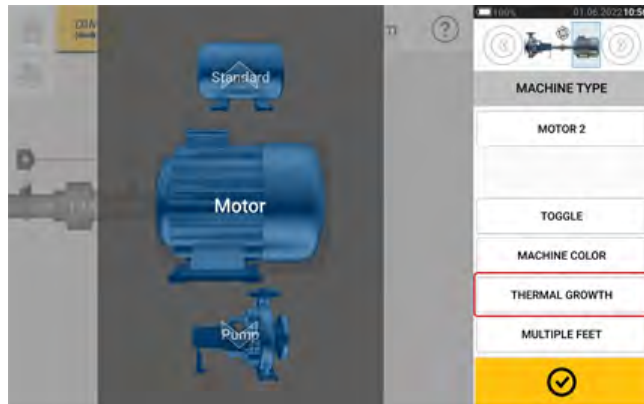

With machine carousel shown, tap the item "Thermal growth" to access the thermal growth screen.





Thermal growth values can be entered only when machine feet have been defined.

To enter any specified thermal growth value at the required foot position, tap the related value

box then proceed to enter the thermal growth value using the onscreen keyboard. Use  to cycle through the value boxes. Alternatively, tap the desired foot position.



Thermal growth values are activated by swiping the icon  to the right [1]. When thermal growth values are enabled, the corresponding machine within the mini train inset at the top-right corner is shown in orange [2]. After thermal growth values have been entered, tap  to proceed.

### Thermal growth calculator

The calculator is used to calculate thermal growth compensation if no other values are available. Thermal growth is calculated from the material coefficient of linear thermal expansion, expected temperature difference and length of the shaft centerline from the shim plane.

When in the thermal growth screen, tap value box of feet pair [1] where thermal growth is to be entered.



The box is highlighted blue [2], and the 'Calculator' tab [3] comes into view.

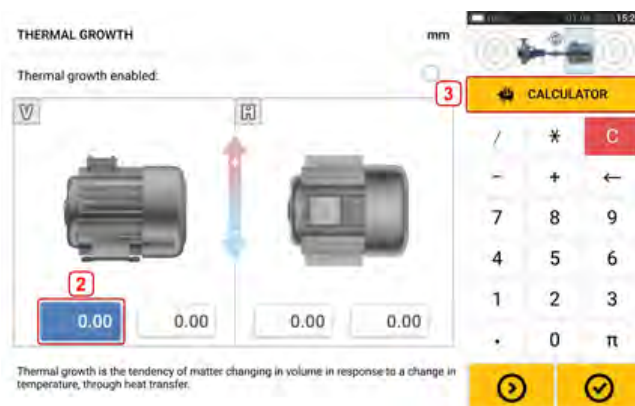

Tap 'Calculator' tab [3] to access the thermal growth calculator screen.

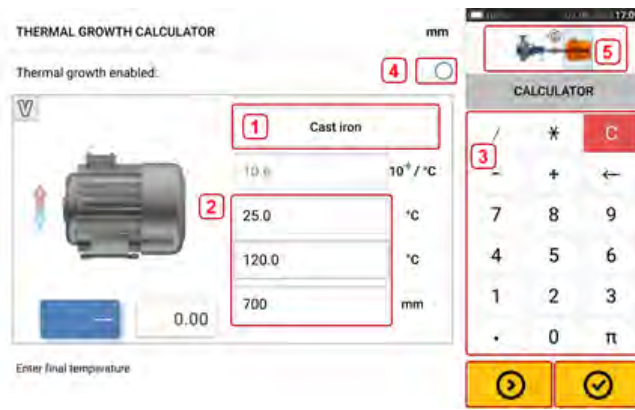

Tap **(1)** and select machine material. The related linear thermal expansion is shown. Enter the three values **[2]** required to calculate the thermal growth value for the selected feet pair. Use the onscreen keyboard **[3]** which comes into view when any one of the three value boxes **[2]** is tapped. The three values are:

- Ambient temperature (initial temperature)
- Machine running temperature (final temperature)
- Distance from machine base (or shimming plane) to the shaft centerline (length)

With thermal growth values enabled **[4]**, the corresponding machine within the mini train inset at the top-right corner is shown in orange **[5]**.

Tap **[6]** to simultaneously display the calculated thermal growth value for the respective feet pair **[6]** and toggle to the next feet pair **[7]**.

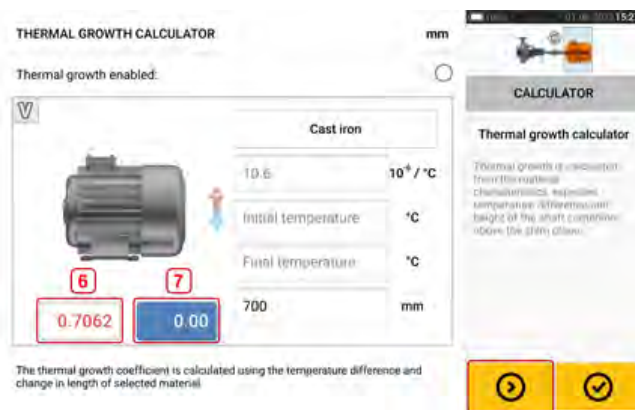

Tap **[7]** to return to the thermal growth screen showing the calculated values.

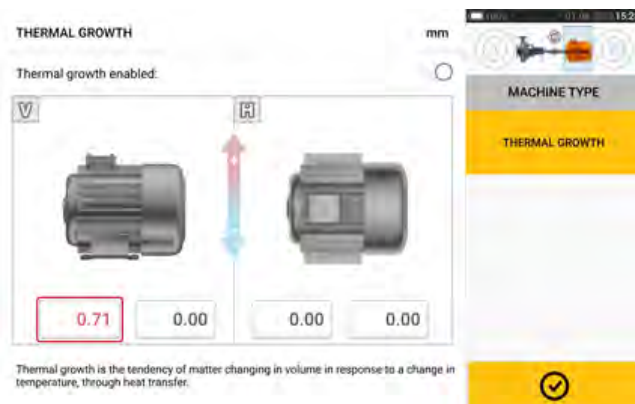

## Multiple feet

The item "Multiple feet" is primarily used to determine foot corrections in a multiple feet machine, and is therefore accessible also in the result screen.

The dimension between the feet may be defined in the 'Multiple feet' screen which is accessed by tapping the item "Multiple feet".

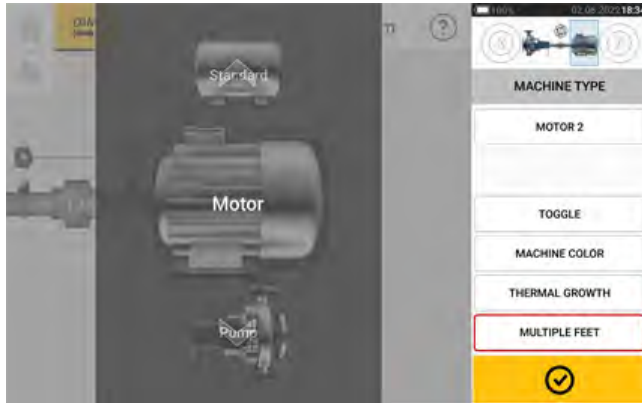

If already entered, the 'Multiple feet' screen will show the dimension between the front feet and the back feet [1].





### Note

The intermediate machine feet are not displayed in the dimension screen.

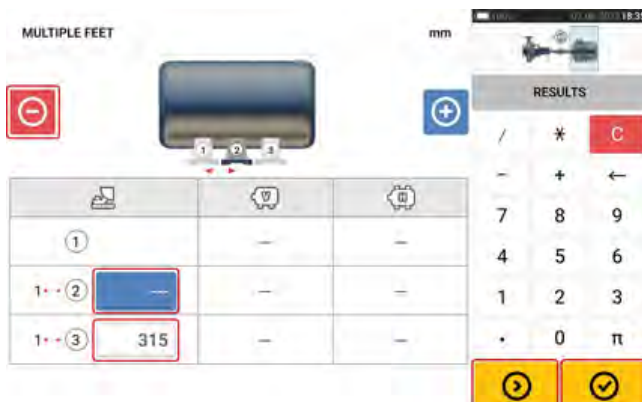
Tap  to add any intermediate feet.



- The intermediate feet pair is added after the front feet.
- Enter this dimension in the row that comes into view.
- If desired, intermediate feet may be deleted by tapping .
- Tap  to exit the 'Multiple feet' screen.



## Coupling properties

From the dimensions screen, tap coupling to access coupling carousel.

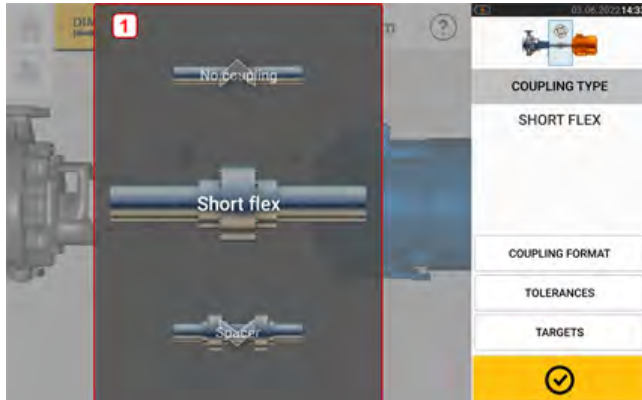

Swipe the carousel [1] up or down and select desired coupling type. The following coupling types are available for selection:

- Short flex — These couplings feature fitted transmission elements with play (such as teeth, claws or bolts) or elastic connecting elements like rubber 'tires' or springs.
- Spacer shaft — When the coupling halves are joined by a spacer element, its length must be entered.
- Single plane — The coupling halves are bolted directly together. Loosen the bolts before taking measurements, since they would otherwise distort the true alignment condition.
- No coupling — This coupling format is intended for use with CNC machines. In this format, the length between the two shafts must be entered.

### Targets

Targets are misalignment values specified as an offset and an angle in two perpendicular planes ( horizontal and vertical) and used to compensate for dynamic loads.

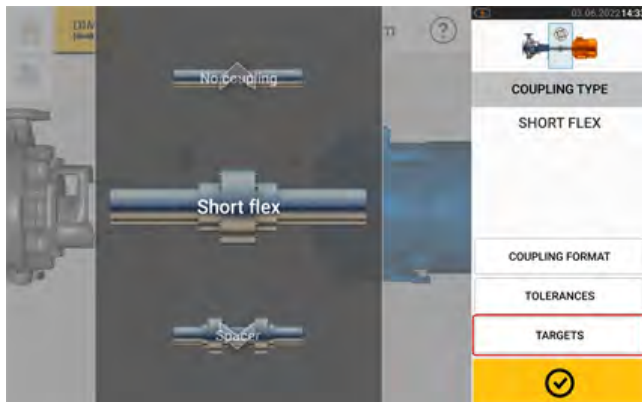

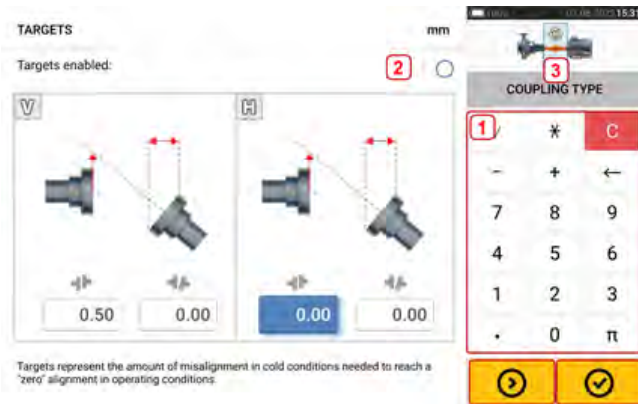

With coupling carousel shown, tap the item "Targets" to access the coupling targets screen.



The shown coupling format depends on the type of coupling selected.

To enter any target specifications at the coupling, tap the related value box then proceed to enter the target value. Use the onscreen keyboard [1] which comes into view when any one of the four value boxes is tapped. Use  to cycle through the value boxes. Alternatively, tap the desired value box.

Tap  [2] to activate target specification values. When target values are enabled, the coupling [3] within the mini train inset at the top-right corner is shown in orange. After target values have been entered, tap  to proceed.

## Tolerances

Alignment quality is evaluated through comparison with tolerances based upon entered machine dimensions and RPM.

The tolerance ranges are compiled as tables according to type of coupling, coupling format, and diameter (for the gap value) as well as RPM. When the coupling type is spacer, the tolerance table values are determined by the length of the spacer shaft and the RPM.

Tolerances are accessed through the dimensions screen.



Tap the coupling [1]. The coupling carousel is shown.

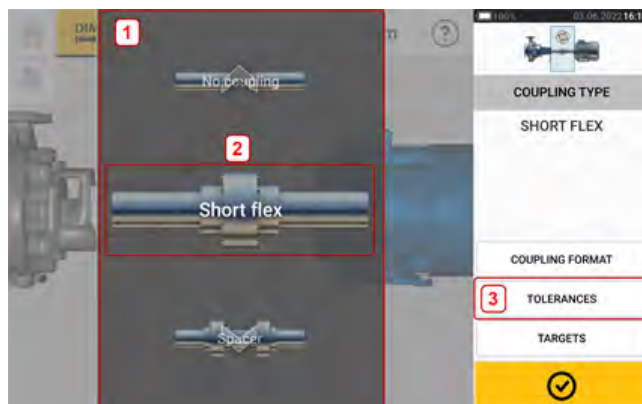

Swipe the carousel [1] to select the desired coupling type [2] then tap the item "Tolerances" (3) to access tolerances screen which shows the coupling tolerance table.

### Available tolerance tables

The shown tolerance tables are based on machine operating frequency.



Tap  [1] to enable selected tolerances. Tap (2) to select desired type of tolerance. A pop-up menu [4] with available tolerances comes into view.

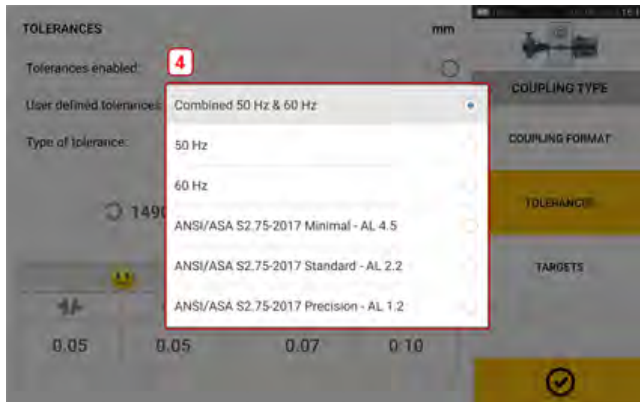



The tolerance table [3] shown previously is related to the selected type of tolerance.

## ANSI standard specification tolerances

The Acoustical Society of America (ASA) developed shaft alignment tolerances for both short flex and spacer couplings on standard rotating machinery. These tolerances are an approved American National Standards Institute (ANSI) specification, and are grouped into three tiers (minimal, standard and precision). ANSI tolerances are selected from the type of tolerance pop-up menu mentioned before.

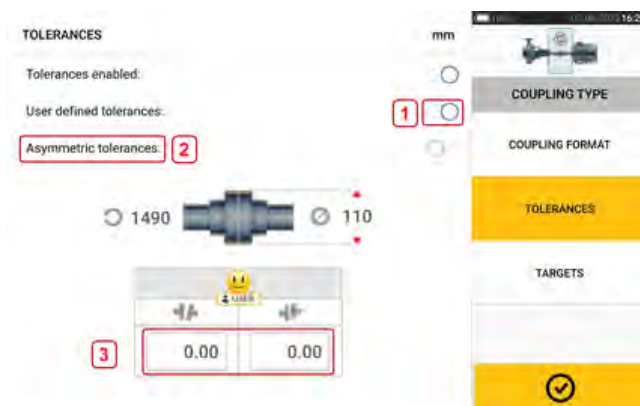
## User defined tolerances



Tap  [1] to enable user defined tolerances. Asymmetric tolerances (2) can be activated only when user defined tolerances are enabled. In asymmetric tolerances, the tolerance values for the two coupling planes are not the same. Tap (3) to edit user defined tolerances.

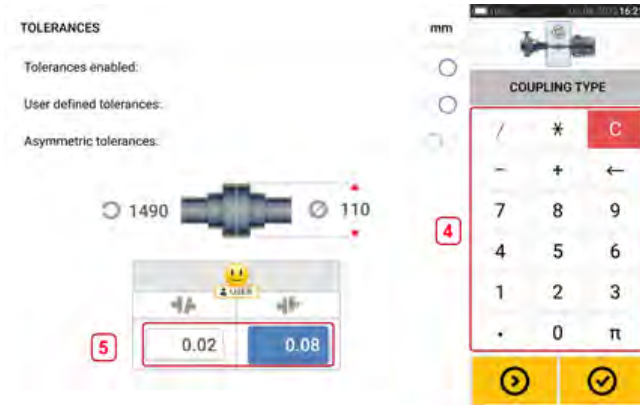

Use the onscreen keyboard (4) that comes into view. The edited values are shown (5).

## Asymmetric and symmetric tolerances

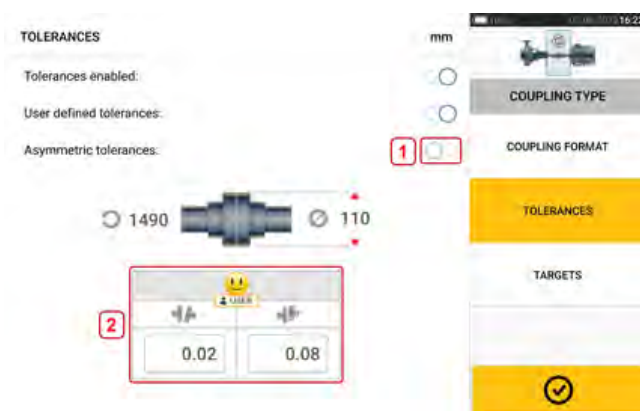

When asymmetric tolerances have not been enabled (1), the displayed specified tolerances (2) are symmetric. The gap and offset tolerances for both horizontal and vertical planes are identical.

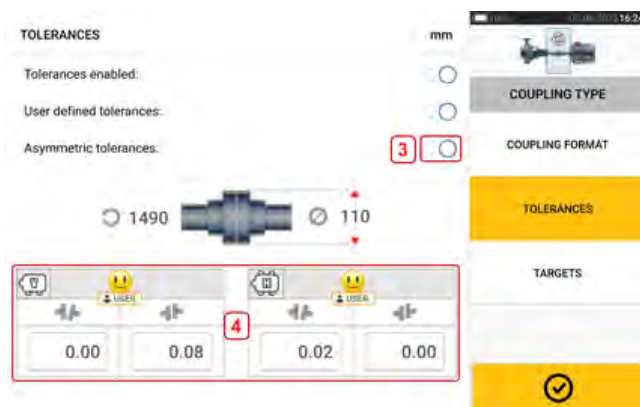

If asymmetric tolerances are enabled (3) all four specified values are displayed (4).

## Tolerance table based on coupling format

For the same type of tolerance, RPM, and coupling diameter, the tolerances value differ with the coupling format selected. To select the necessary coupling format, tap the item "Coupling format" in the tolerances screen.

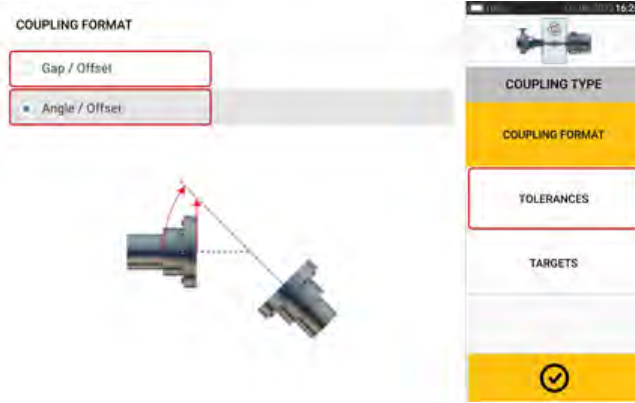

Select necessary coupling format, then tap the item "Tolerances" to view tolerances based on the selected coupling format.

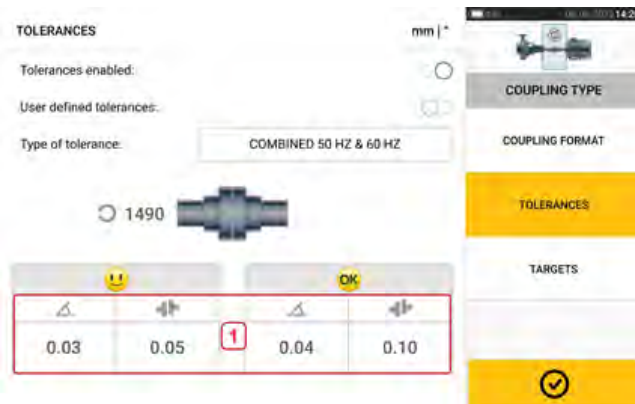

[1] shows the tolerance table for the given short flex coupling and RPM. The coupling format is angle/offset.







[2] shows the tolerance table for the given short flex coupling, diameter and RPM. The coupling format is gap/offset.

 **Note**  
 There are no tolerance tables for consolidated spacer shaft coupling formats. Consolidated formats consider the spoolpiece or jackshaft as an extension of either the right or left shaft.

**Suggested consolidated shaft alignment tolerances**

The following table shows the consolidated (50 Hz and 60 Hz) tolerances

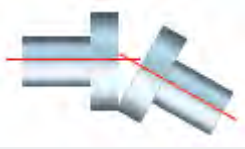
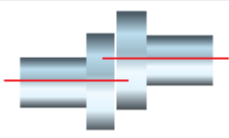
	RPM	metric (mm)		imperial (mils)	
		Acceptable 	Excellent 	Acceptable 	Excellent 
<b>Short flexible couplings</b> Gap (per 100 mm or 10" diameter) 	600	0.15	0.10	14.9	10.0
	750	0.12	0.08	12.3	8.2
	900	0.10	0.07	10.5	7.0
	1000	0.10	0.06	9.6	6.4
	1200	0.08	0.05	8.2	5.4
	1500	0.07	0.04	6.7	4.5
	1800	0.06	0.04	5.7	3.8
	3000	0.04	0.02	3.7	2.5
	3600	0.03	0.02	3.1	2.1
	6000	0.02	0.01	2.0	1.3
	7200	0.02	0.01	1.7	1.1
<b>Offset</b> 	600	0.23	0.13	9.0	5.1
	750	0.18	0.10	7.3	4.1
	900	0.16	0.09	6.1	3.4
	1000	0.14	0.08	5.5	3.1
	1200	0.12	0.07	4.6	2.6
	1500	0.09	0.05	3.7	2.1
	1800	0.08	0.04	3.1	1.8
	3000	0.05	0.03	1.9	1.1
	3600	0.04	0.02	1.6	0.9
	6000	0.02	0.01	1.0	0.6
	7200	0.02	0.01	0.8	0.5

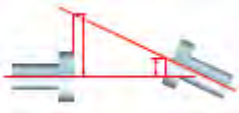
	RPM	metric (mm)		imperial (mils)	
		Acceptable 	Excellent 	Acceptable 	Excellent 
<b>Spacer shaft and membrane (disk) couplings</b> Offset (per 100 mm spacer length or per 1" of spacer length) 	600	0.30	0.18	3.0	1.8
	750	0.24	0.14	2.4	1.4
	900	0.20	0.12	2.0	1.2
	1000	0.18	0.11	1.8	1.1
	1200	0.15	0.09	1.5	0.9
	1500	0.12	0.07	1.2	0.7
	1800	0.10	0.06	1.0	0.6
	3000	0.06	0.04	0.6	0.4
	3600	0.05	0.03	0.5	0.3
	6000	0.03	0.02	0.3	0.2
	7200	0.02	0.01	0.2	0.1



## Laser beam adjustment (sensALIGN 3)

### Adjust sensor and reflector until the laser beam status LED blinks green



#### Note

Make sure that the reflector and sensor lens are clean. Use a soft lint-free cloth. A lens cleaning cloth is supplied.

The sensor and reflector need to be adjusted so that the laser beam strikes the reflector and is reflected back into the sensor.



#### WARNING

Do not stare into the laser beam!

1. Remove the sensALIGN 3 dust cap (1) and then switch the sensor on by pressing its On/Off switch (2).

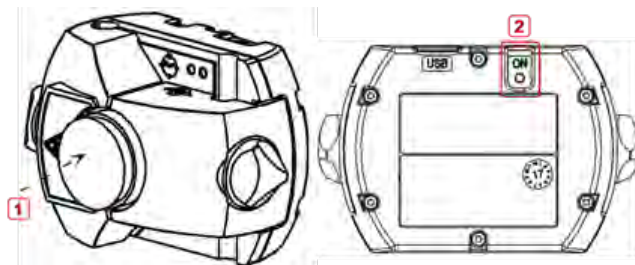

1) Sensor dust cap



#### WARNING

Do not stare into the laser beam!

2. Leave the reflector dust cap on. If the sensor and reflector have been roughly positioned to each other during mounting, the laser beam should strike the reflector dust cap and is readily visible. If the beam be so far off target that it misses the reflector completely, hold a sheet of paper in front of the reflector to locate the beam and readjust it as follows:

3. With the reflector dust cap still in place, reposition the components until the laser beam strikes the center of the target on the reflector dust cap:

- vertically: slide the reflector or sensor up and down along the support posts. Use the thumbwheel (1) on the side of the reflector housing. To move the sensor, loosen the yellow knobs (2).

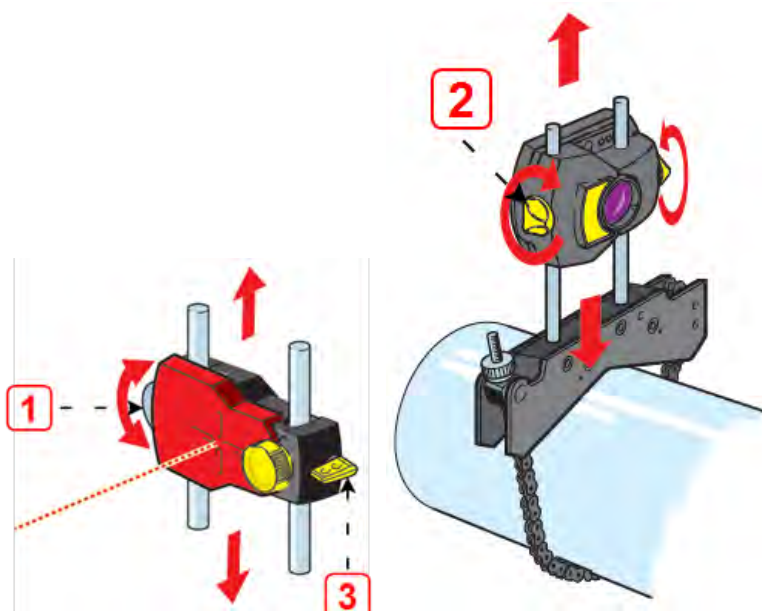

The lever (3) must always be in the horizontal position except for mounting and dismounting.

- horizontally: loosen one of the brackets on the shaft and rotate it slightly and then retighten.

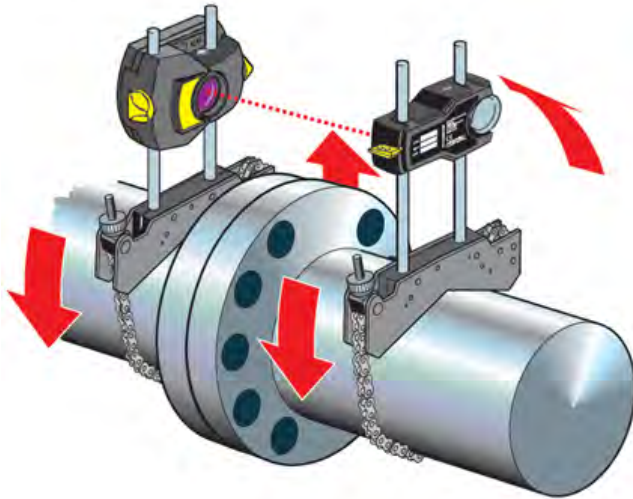

This correction is necessary if the laser beam is too far left or right.

4. Remove the reflector dust cap so that the laser beam strikes the reflector and is reflected back to the sensor. The sensor laser beam adjustment LED will indicate the beam adjustment condition.



**Note**

If required, the laser adjustment wizard may be used to center the laser beam on the sensor detector.

## Laser beam adjustment

### Laser adjustment wizard

The laser adjustment wizard is the primary laser beam adjustment feature in the touch device. If the sensor is initialized, and the laser beam is not centered, use the wizard to adjust the laser beam correctly. The wizard arrows indicate the direction and amount in which movement should take place.

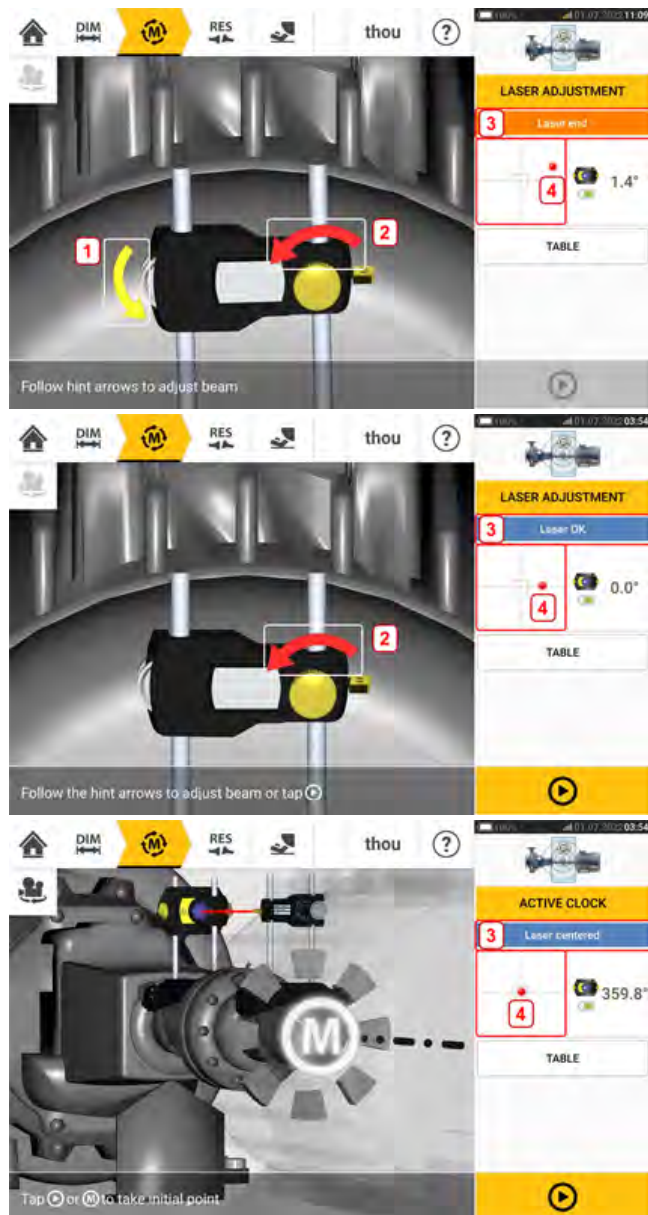

- The wizard arrows next to the vertical position adjustment thumbwheel (1) and the horizontal adjustment knob (2) indicate the direction and magnitude in which the thumbwheel or the knob is to be moved in order to adjust the laser beam correctly.
- The attained laser beam status is shown in 3.
- 4 shows the position of the laser beam on the position detector.
- The wizard arrows decrease in magnitude and occurrence as the laser beam status

- improves, disappearing completely once the laser beam is centered.
- Measurement may commence once the laser beam is centered.

## XY View

The XY View function is used to help center the laser beam on the position detector before measurement can continue.

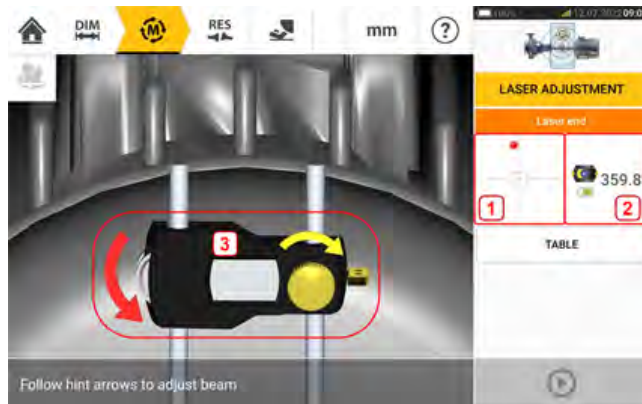

- Tap the shown detector area (1) to directly access the XY View screen.
- The XY View screen can be accessed through the menu item "XY View" which is shown when the "sensor area" (2) is tapped.
- The XY View screen can be accessed through the menu item "XY View" which is shown when the reflector (3) is tapped.

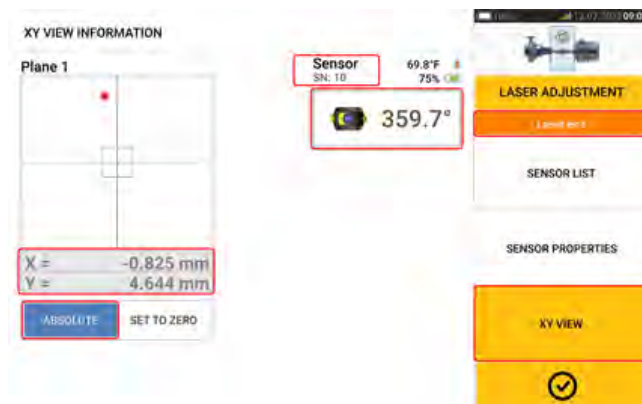

Displayed are the absolute X,Y coordinates of the laser beam on the position detector, the angle at which the sensor is currently positioned on the shaft and the sensor serial number. Use the adjustment knob and the adjustment thumbwheel to center the laser beam dot on the position detector. In some cases it can be necessary to move the sensor along the support posts or sideways. To move sensor sideways, loosen the chain type bracket then slightly rotate the bracket.

The "Set to zero" function may be used to check the effect of environmental and machinery vibration on the measurement.

**Note:** "Set to zero" is active only when the laser beam status [1] is "OK" or "Centered".

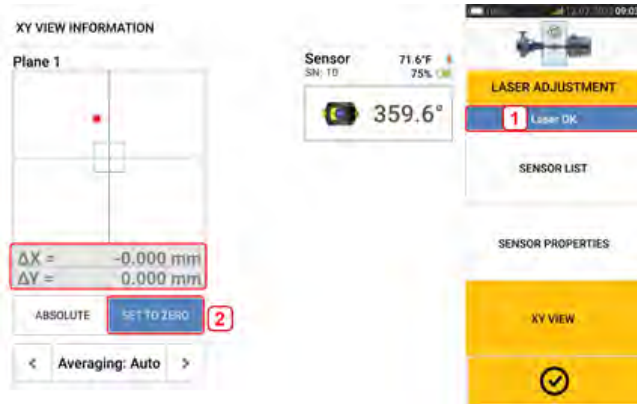

If the laser beam status is "OK" or "Centered" [1] tap "Set to zero" [2] to set the current laser dot position as 0,0. The  $\Delta X, \Delta Y$  values are then monitored to check the stability of the values. Tap "Absolute" to return to the absolute values.

Note: Shown menu items are used to show these items:

Sensor list – displays serial number of sensors detected or previously used, as well as type of connection used for communication.

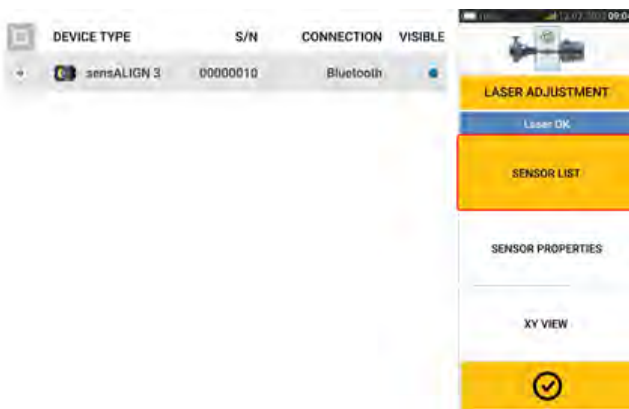

Sensor properties – displays detailed information of the sensor unit in use

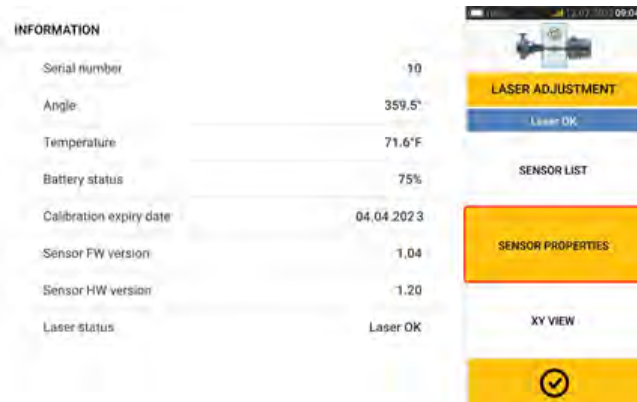

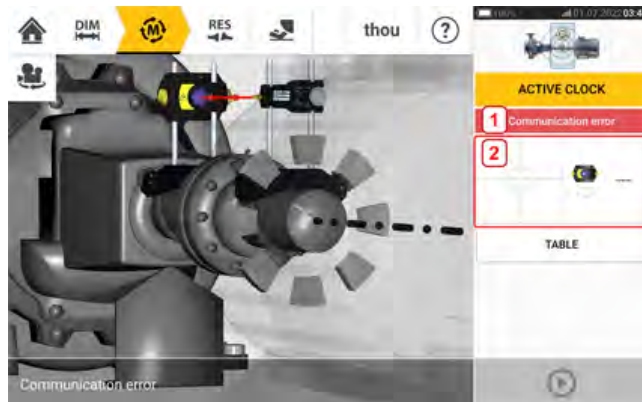

## Initialize sensor

The hint "Communication error" [1] suggests that the sensor has not been initialized although the laser beam may have been correctly adjusted.

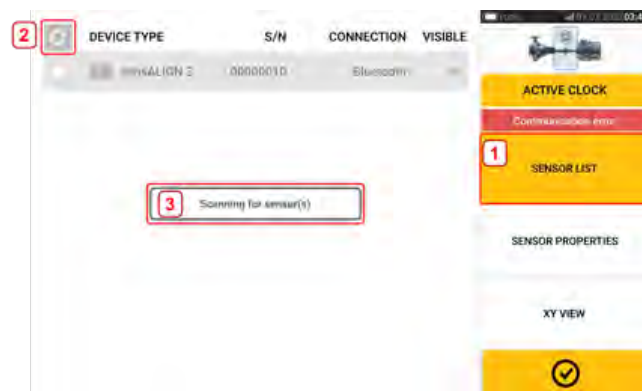

Tap the detector and sensor area [2] to access the menu item 'Sensor list'.



Tap menu item 'Sensor list' [1] to see scanned sensors, then tap  [2] to scan sensors. The hint 'Scanning for sensor(s)' [3] comes into view.

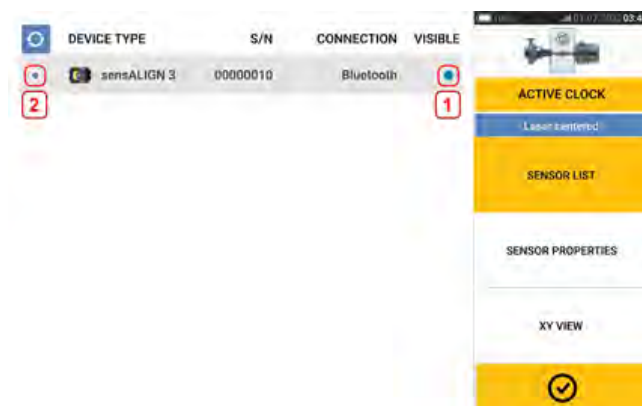

When the sensor is detected, it is listed down and a blue bold dot [1] is shown next to the detected sensor.

Tap the listed sensor to initialize. When the sensor is initialized, a bold blue dot [2] is shown.

## Measurement

Active Clock is the default measurement mode for horizontal machines, and Static Clock is the default mode for vertical machines.

For horizontal machines, Static Clock measurement mode can be selected while in the measurement screen.

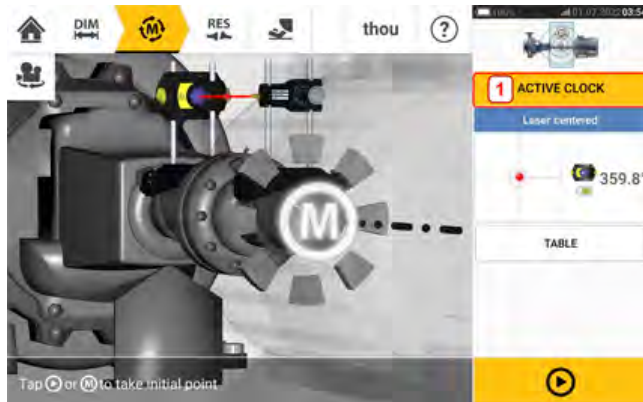

Tap the measurement mode header [1] to access the measurement mode carousel.

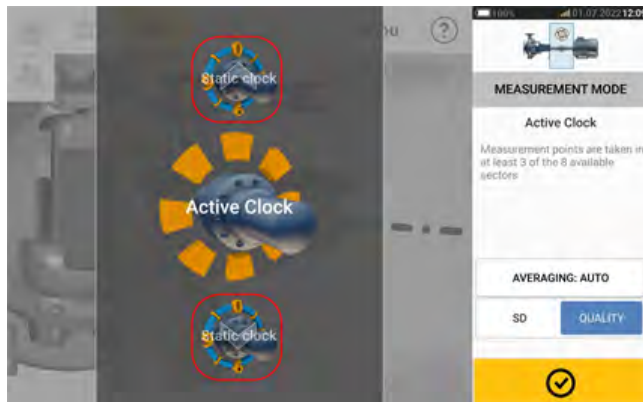

Swipe the carousel up or down and select desired measurement mode.

In the above example, Active Clock measurement mode has been selected. The quality of the measurement may be displayed either as a measurement standard deviation (SD) or measurement quality factor.

**Standard deviation (SD)** is the root mean square deviation (mean of the means) of the measurement points. It describes how closely a group of data points are clustered around the average of those data points. It is a measure of the measurement caliber. The smaller the SD, the better the quality of the data collected.

**Measurement quality** is a factor defined by the following measurement and environmental criteria: angular rotation, standard deviation of the measurement ellipse, vibration, rotation evenness, angular rotation inertia, direction of rotation, speed and filter output. The higher the factor, the better the quality of measurement.

Tap the related item to set required factor; tap the 'Averaging' button to set average.

### Averaging

To attain the desired accuracy in certain industrial conditions, it can be necessary to increase the number of measurements (recorded laser pulses) to be averaged when readings are taken. Particular cases include environments with increased machinery vibration. An increased averaging also improves the accuracy when measuring sleeve bearings, white metal bearings and journal bearings.





Tap the 'Averaging' button [1] to set the averaging. A scale [2] used to set the averaging value comes into view. Tap desired averaging value which then appears in the 'Averaging' button [1].

## Measurement modes

---

These measurement modes are available in Fluke 831:

- Active Clock – This is the default measurement mode used to measure horizontal standard coupled machines. In this mode, measurement points are taken at any 3, 4, 5 or all 8 available sectors. A minimum of three measurement points is required to determine the alignment condition, but more measurement points over a wider rotational angle is recommended.



**Note**

The default number of Active Clock measurement points is set in configuration under the menu item 'Default settings'.

- Static measurement – This is the default measurement mode used to measure vertical mounted machines (four feet or flange-mounted). It is also used measure horizontal machines with uncoupled and nonrotatable shafts.

## Active Clock measurement

In Active Clock, measurement points can be taken between a minimum of 3 to a maximum of 8 available sectors. The range in which the sectors become active and therefore points may be taken is the given clock position (in degrees)  $\pm 11.25$  degrees. For example, the 1:30 o'clock position will be active when the sensor and reflector are at a rotational angle between 34 - 56 degrees.

Clock position	0:00	1:30	3:00	4:30	6:00	7:30	9:00	10:30
Active Clock range in degrees	349 - 11	34 - 56	79 - 101	124 - 146	169 - 191	214 - 236	256 - 281	304 - 326

Active Clock is the default measurement mode used to measure standard horizontal coupled machines. Measurement points are taken at any of the eight available sectors. The desired number of measurements points is set in "Configuration" under 'Default settings'. Three measurement points are necessary to determine the alignment condition.

Once the laser beam has been centered, rotate shafts to the first measurement position



### Note

If coupling torsion play (backlash) is suspected, turn the shaft or coupling end where the reflector is mounted. Ensure shafts are turned in the normal rotation direction of the machine, and that the mating parts are engaged. Backlash may also be minimized by taping tight the coupling.

Remember not to touch mounted components. This includes the brackets and the support posts, which are NOT to be used to rotate the shafts.

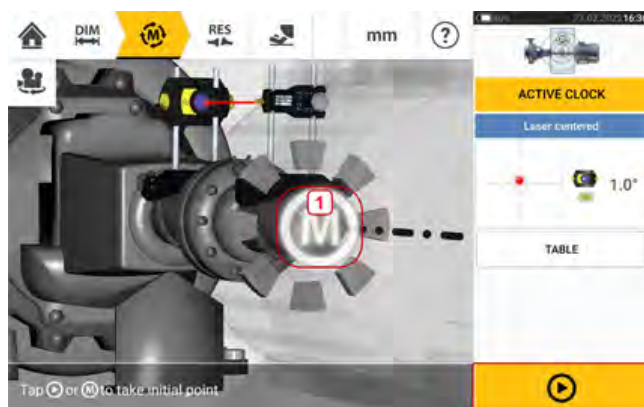

When the sensor and reflector are within the sector range, a pulsating **M** (1) comes into view.

Tap the pulsating **M** or  to take the first measurement position.

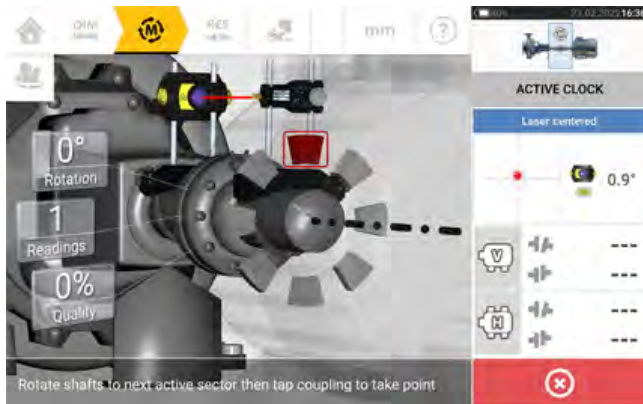

After measurement is taken, the sector is highlighted red. This is an indication of the measurement quality. Rotate shafts to the next sector, then tap the pulsating **M** to take measurement. Repeat this step for the set active points. The color of the measured sectors shows the attained measurement quality.

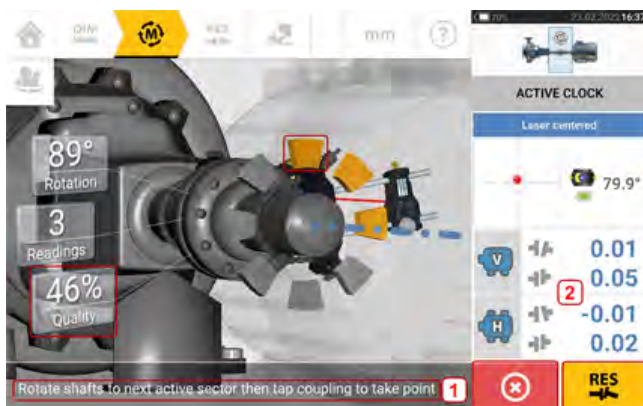

The attained measurement quality is also shown as a percentage. In this particular example, the number of active points set is 4 and therefore the hint (**1**) to take a further measurement point. Note: Coupling results (**2**) are displayed because three measurement points are sufficient to determine the alignment condition.

To view alignment results at this stage, tap .

Tap  to cancel measurement.



**Note**

As shafts are rotated, and depending on the physical condition of the machines, the active clock sectors change color from red (quality < 40%) to amber ( quality  $\geq 40\% < 60\%$ ) to green (quality  $\geq 60\% < 80\%$ ) to blue (quality  $\geq 80\%$ ). Coupling results are displayed as soon as the measurement quality attains 40% and the minimum 3 measurement points have been taken ( active clock sector turns amber).

Once the set number of active clock measurement points is attained, results are shown.



- **(1)** Vertical feet position (bold colored tolerance arrows show direction to move/correct machine feet)
- **(2)** Horizontal feet position (bold colored tolerance arrows show direction to move/- correct machine feet)
- **(3)** Vertical coupling results
- **(4)** Horizontal coupling results
- **(5)** Selected results mode
- **(6)** Alignment condition tolerance icon
- **(7)** Used to select Horizontal and Vertical feet and coupling results in 3D / 2D
- **(8)** Save asset measurement results
- **(9)** Create asset measurement result report
- **(10)** Show asset measurement table
- **(11)** Tap  to start Live Move

## Taking measurement points automatically

Measurement points may be taken automatically if the default setting item "Take points automatically after stabilization" has been activated. The item 'Default settings' is found under "Configuration".

The initial measurement is taken by tapping either the pulsating **M** or  after stabilization.

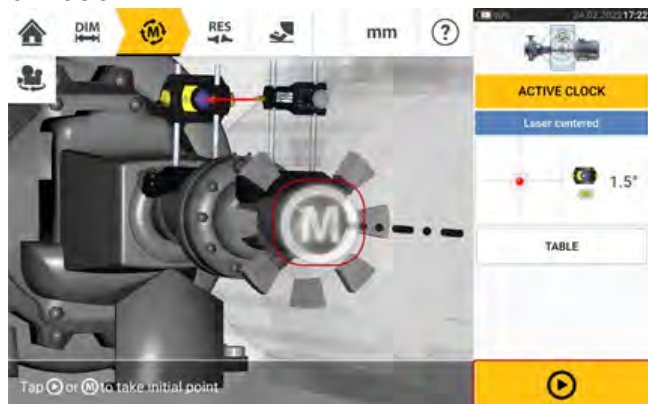

When the rotational angle of the sensor and reflector is within the sector range, a series of dots in circular motion (**1**) indicate the stabilization process. Once this occurs stop the rotation of the shafts and wait for the pulsating **M** to appear.

The subsequent measurement points are taken automatically. The shafts are rotated to the next sector range. Once stabilization begins, hold shafts at that position and wait for measurement to be taken automatically. Repeat the procedure until all set active clock measurement points are taken.



## Static measurement

This measurement mode is used for uncoupled shafts, nonrotatable shafts and vertical foot-mounted or flange-mounted machines.

If not yet completed, enter dimensions then center laser beam.

Use the measurement mode carousel (refer to Measurement) and select static measurement mode (Static Clock).

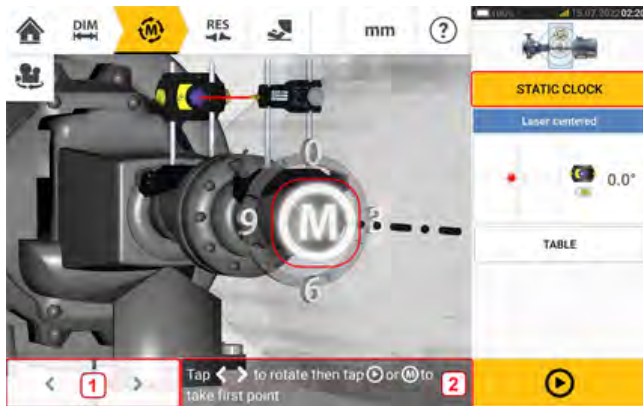



- **(1)** 'The 'left/right' navigation icons are used to position the displayed sensor and reflector at the same angular position as the actual components mounted on the shafts.
- **(2)** On-screen hint to position displayed sensor and reflector then take measurement point

Turn the shafts to any of the eight 45° positions (i.e. 12:00, 1:30, 3:00, 4:30, 6:00, 7:30, 9:00 or 10:30 o'clock position viewed from reflector towards sensor). Use either an external inclinometer or protractor and position shaft as accurately as possible. Tap the pulsating **M** or

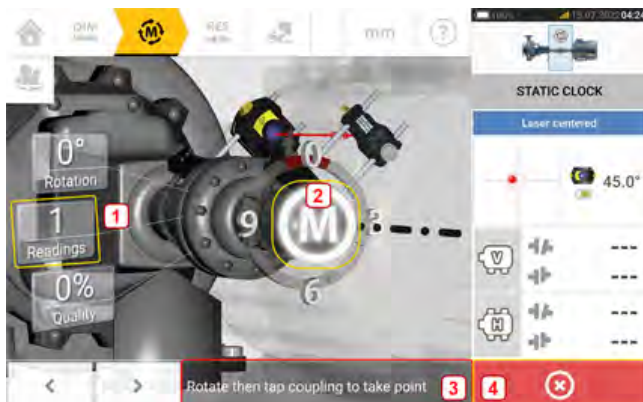
 to take the first measurement point.





- **(1)** Number of points already taken (in this example initial point)
- **(2)** Tap pulsating **M** to take next measurement
- **(3)** On-screen hint to position displayed sensor and reflector then take measurement point
- **(4)** 'Cancel' icon – used to cancel current measurement and start new measurement

Rotate shaft to the next measurement position. The displayed sensor and reflector must be at the same angular position as the mounted components. Use  or  to position the displayed sensor and laser then take next measurement point by tapping the pulsating **M** **[2]**.



**Note**

After measurement point is taken, the displayed sensor and reflector move to the next clock position on the display.

If shaft rotation restrictions hinder measurements at particular shaft positions to be taken, use  or  and bypass the positions.

Measurements must be taken in at least three positions over 90°, but more measurements over a wider angle is recommended.



- **(1)** Rotational arc shows rotational angle covered by the shafts during measurement. The color of the arc sectors shows the attained measurement quality **(4)**.
- **(2)** Rotational angle completed by the shafts for current measurement
- **(3)** Number of measurement points taken for current measurement
- **(4)** Measurement quality for current measurement
- **(5)** Results icon – tap to view results.



## Extend measurement range manually

Measurement range may be extended manually in both Active Clock and Static measurement modes. This range extension allows the adjustment of the laser beam such that it does not miss the detector surface when shafts with gross misalignment or angular misalignment over large distances are measured. During measurement, manual extension is prompted when the XY view is accessed before 'Laser End' is displayed.

- If the laser dot (1) on the display continues to move further away from the center of the detector screen while shafts are rotated for measurements, tap the detector area (2) to open the "XY view" screen.

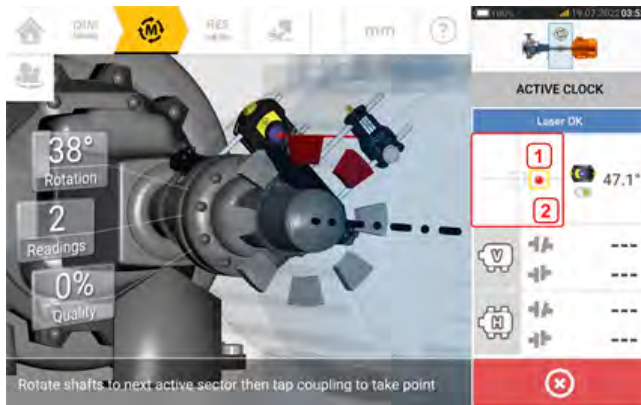



- With the "XY view" open, use the yellow horizontal angle adjustment knob and the vertical position adjustment thumbwheel to adjust the laser dot such that it is positioned inside or very close to the square target.



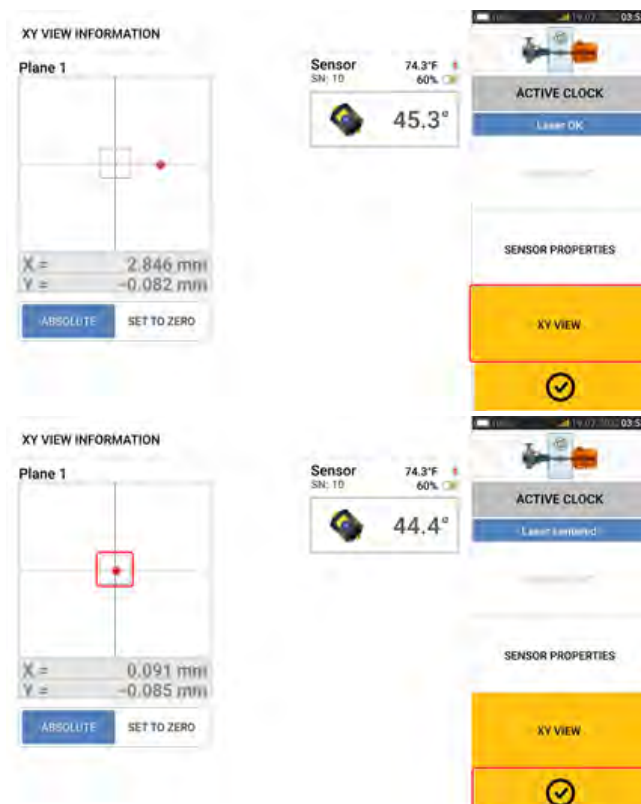

### Note

Do not adjust the sensor during the laser adjustment procedure.

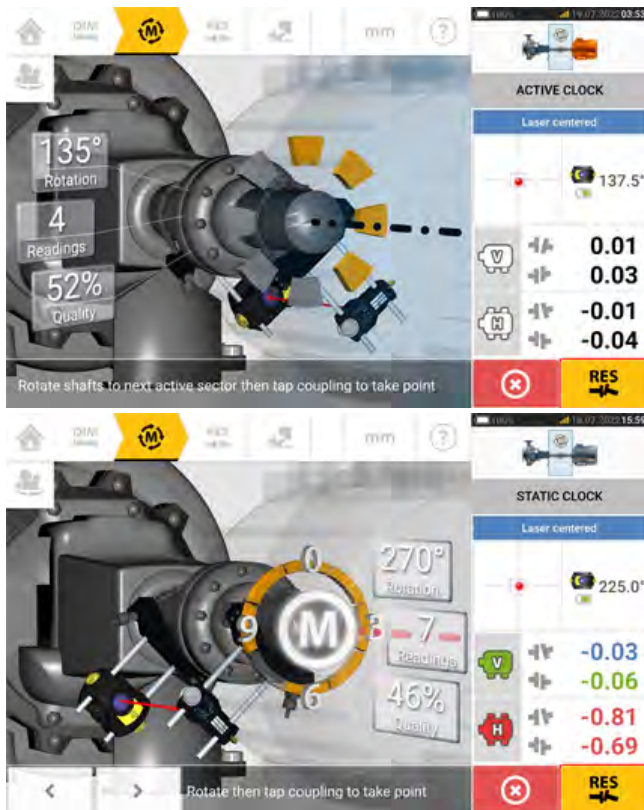

- With the laser beam centered, tap  then continue with measurement by rotating the shafts further.



- Rotate the shafts through as wide an angle as possible, then tap  to view results.



**Note**

When Active Clock mode is used, it is recommended to take all set active measurement points. Once all set points are taken, the results screen is automatically shown once measurement is stopped.

## Measurement table

The measurement table is used to register and display all Shaft alignment, and any Live Move measurements taken on the current couplings. From the results screen, tap either the item TABLE [1] or shown coupling results [2] to open the measurement table.

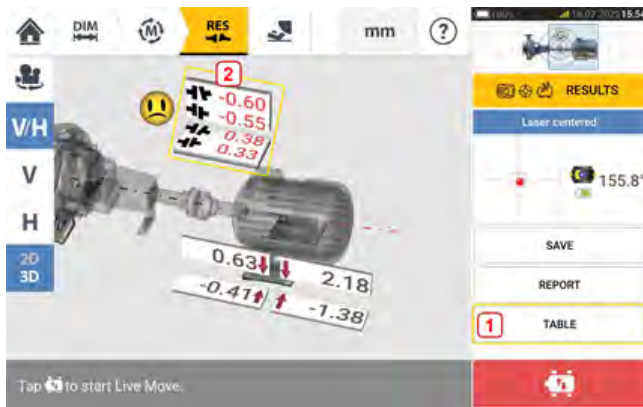

These items are included in the measurement table for each measurement:

MEASUREMENT TABLE mm

MEAS.	VERTICAL	HORIZONTAL	QUALITY			
OF	SD					
AS FOUND 14	-0.023	-0.069	0.779	0.005		
1	0.023	-0.069	0.779	0.005	72%	0.011
2	0.031	-0.054	0.764	-0.023	41%	0.101
H MOVE 15	-0.023	-0.069	0.037	-0.025		
AS LEFT 16	-0.022	-0.007	0.047	0.014		
1	-0.022	-0.007	0.047	0.014	95%	0.003

MEASUREMENT TABLE mm

MEASUREMENT DETAILS						SENSOR
DATE & TIME	DISTANCE	PRISM	AVG [s]	ROTATION	EXTEND	S/N
19.07.2022 03:17:58	85	155	Auto	Auto		21
19.07.2022 03:52:08	85	155	Auto	Auto		21
20.07.2022 09:09:17	85	155	0.50			21
20.07.2022 09:09:37	85	155	Auto	Auto		21

MEASUREMENT TABLE mm

MEASUREMENT DETAILS					SENSOR	
DISTANCE	PRISM	AVG [s]	ROTATION	EXTEND	S/N	RECAL
85	155	Auto	Auto		21901862	09.01.2024
85	155	Auto	Auto		21901862	09.01.2024
85	155	0.50			21901862	09.01.2024
85	155	Auto	Auto		21901862	09.01.2024

- **(1)** Tap the check box to include the measurement in calculation of the averaged results which are shown on the results screen. Included measurements have a green check mark. The check mark remains grayed out if the measurement is not selected.
- **(2)** Measurements in chronological order
- **(3)** Used measurement mode
- **(4)** The rotational angle covered during measurement
- **(5)** Vertical and horizontal gap and offset values
- **(6)** Measurement quality factor (QF)
- **(7)** Measurement standard deviation (SD)
- **(8)** Date and time when measurement was taken
- **(9)** Dimension sensor-to-coupling centre
- **(10)** Dimension sensor-to-reflector (prism)
- **(11)** Averaging used
- **(12)** Direction of shaft rotation during measurement
- **(13)** Serial number of sensor used and recalibration due date

The "AS FOUND" coupling result **(14)** shows the initial alignment condition of the machines before any Live Move is performed. The displayed result could be an average of selected measurements. In the above example, the "AS FOUND" coupling result is based on selected measurement number 1 only.

The "MOVE" result **(15)** shows the alignment condition after Live Move.

The "AS LEFT" coupling result **(16)** shows the alignment condition measured after Live Move. The displayed result could be an average of selected measurements. In the following table, the "AS LEFT" coupling result is based on measurement number 1 only.

Swipe horizontally to view all columns in the table and vertically to view all rows in the table.

Tap  to delete highlighted reading (in this case "AS LEFT") from the measurement table.

Tap  to display the weighting of the quality factor parameters of the measurement.

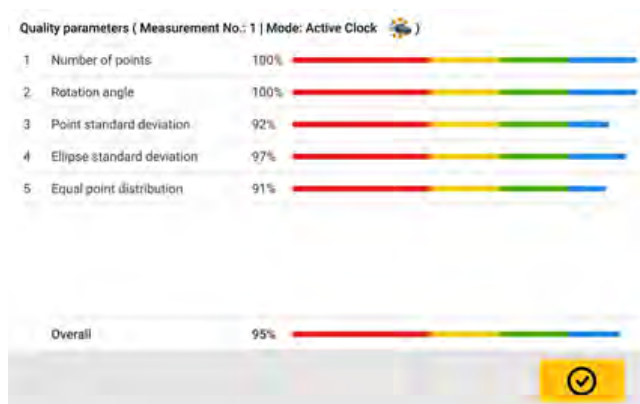

Tap  to exit the measurement table.

## Measurement quality

Measurement quality is depicted using the following color codes:

Blue – excellent; Green – acceptable; Yellow – not acceptable; Red – poor

Measurement quality is based on the following measurement and environmental criteria:

- Number of points – The higher the number of measurement points taken, the better the effect on the quality factor. The measurement points should be spread over as wide a rotational angle as possible.
- Rotation angle – The wider the rotational angle through which the shafts and/or couplings are rotated during measurement, the better the effect on the quality factor.
- Point standard deviation – For every measurement point, a number of readings are taken depending on the set averaging. Point standard deviation is the root mean square deviation of these readings.
- Ellipse standard deviation – This is the root mean square deviation of the measurement points on the calculated ellipse.
- Equal point distribution – In point measurements, it is advisable to take measurements at equal angular steps, say 0°, 45°, 90°, 135°.
- Environmental vibration – the level of external vibration e.g. from neighbouring running machine(s)
- Rotation evenness – the smoothness of the measurement rotation e.g. if there is any friction during the rotation that 'jerks' the shaft
- Angle rotation inertia – abrupt changes in the measurement rotation speed e.g. releasing and re-applying a break during the rotation
- Rotation direction – change in the measurement rotational direction
- Rotational speed – how fast the sensor and/or shaft is rotated during measurement
- Filter output – the amount of measurement data filtered out

## Edit measurement data

To improve the quality of the alignment results, it is possible to edit measurement data that could have been affected by external circumstances such as bracketing touching piping arrangement. Access edit options through the measurement table.

MEASUREMENT TABLE mm

#	MEAS.	VERTICAL		HORIZONTAL		QUALITY	
		V	H	V	H	QF	SD
JOB 11.08.2022							
	AS FOUND	0.07	0.08	-0.06	-0.10		
1		-0.01	0.06	-0.01	-0.02	69%	0.031
1		0.07	0.08	-0.06	-0.10	46%	0.102

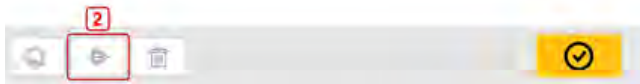







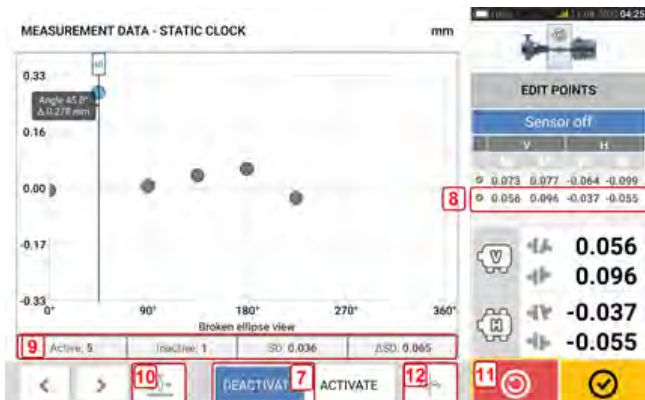
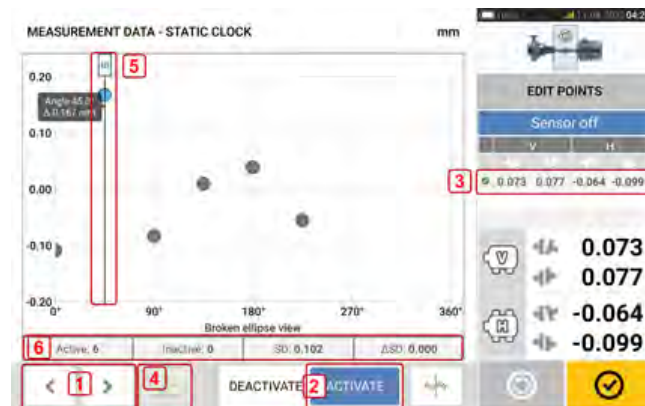



When in the measurement table screen, tap desired measurement (1) then tap (2) to access the measurement data screen.

## Broken ellipse

The deviation diagram used with the rugged device is referred to as 'broken ellipse'. During measurement, the laser beam traverses an arc that is dependent on the alignment condition of the rotating shafts. Over a complete 360° rotation, the beam describes an ellipse. Cutting the ellipse and laying it out flat results in the deviation diagram 'broken ellipse'. In this diagram points out of track are clearly seen.





- **(1)** Tap  or  to cycle through the points.
- **(2)** Currently selected point is active. The point is made inactive by tapping 'Deactivate'.
- **(3)** Shows coupling results for selected measurement. In this example, all measurement points are active.
- **(4)** Tap  to automatically select the point with the highest deviation within the diagram. The cursor **(5)** springs automatically to this point. Note that the icon is inactive when the currently highlighted point has the highest deviation within the group.
- **(5)** The cursor is used to highlight any point in the diagram. The selected point is highlighted blue.
- **(6)** When all measurement points are active, the standard deviation (SD) is displayed.
- **(7)** Currently selected point is inactive. The point is made active by tapping 'Activate'.
- **(8)** Shows coupling results with a measurement point deactivated. In this example, one measurement point has been deactivated.
- **(9)** With a measurement point deactivated, no standard deviation (SD) is displayed.
- **(10)** This icon  is currently active because the measurement point is deactivated and it is therefore, not the measurement point with the highest deviation.
- **(11)** The 'undo' icon  is used to reverse all changes made before saving the asset measurement.
- **(12)** Shows currently displayed deviation diagram or sensor plane. Tap icon to cycle through available deviation diagrams and sensor planes. These include: Broken ellipse []; Ellipse []; Polar ellipse []; Sensor plane []; Sensor plane zoomed [].

Note: This feature shows only when 5 or more measurement points have been recorded.

## What is the effect of deactivating individual points?

Individual points are deactivated in order to lower the standard deviation value. Change in standard deviation impacts the V and H results displayed in the results repeatability table.

MEASUREMENT TABLE		mm					
#	MEAS.	VERTICAL		HORIZONTAL		QUALITY	
		V	H	V	H	QF	SD
JOB 11.08.2022							
	AS FOUND	0.06	0.10	-0.04	-0.06		
1		-0.01	0.06	-0.01	-0.02	69%	0.031
2		0.06	0.10	-0.04	-0.06	55%	0.036

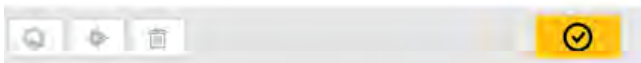

In the above example, deactivating a measurement point has improved the quality factor from 41% to 72%.

## Results

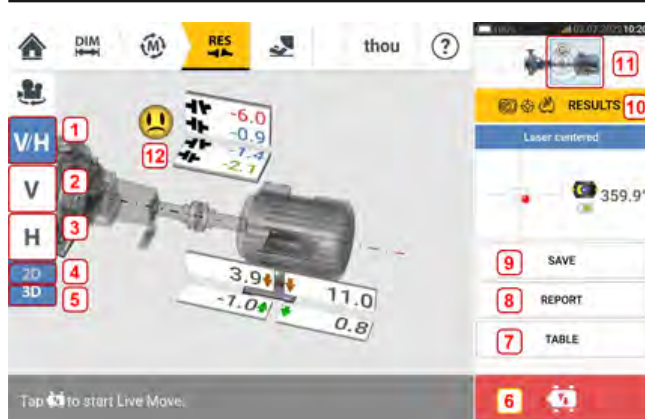

- **(1)** Displays both horizontal and vertical foot and coupling results
- **(2)** Used to display only vertical foot and coupling results
- **(3)** Used to display only horizontal foot and coupling results
- **(4)** Used to display foot and coupling results in 2-D
- **(5)** Used to display foot and coupling results in 3-D
- **(6)** Starts Live Move
- **(7)** Used to display all measurements taken on the coupling
- **(8)** Used to generate asset measurement report
- **(9)** Used to save asset measurements in asset park
- **(10)** Used to select results mode
- **(11)** Tap the slider on the mini train icon to open the triple "Train Manager" / "Train Setup" / "Train Fixation" screen (Note: The machine train manager screen is not active.)
- **(12)** Alignment condition tolerance symbol

In the results screen, the three icons    – dimensions, measurement and results – are active and may be used anytime.

The 2-D V and H foot and coupling results screens show the vertical (V) and horizontal (H) foot positions respectively.

The colors of the bold arrows next to the feet correction values are directly related to the coupling alignment condition as follows:

- Blue – excellent (feet should not be moved)
- Green – acceptable (if possible feet should remain unaltered)
- Red – poor (move feet to attain a better alignment condition)



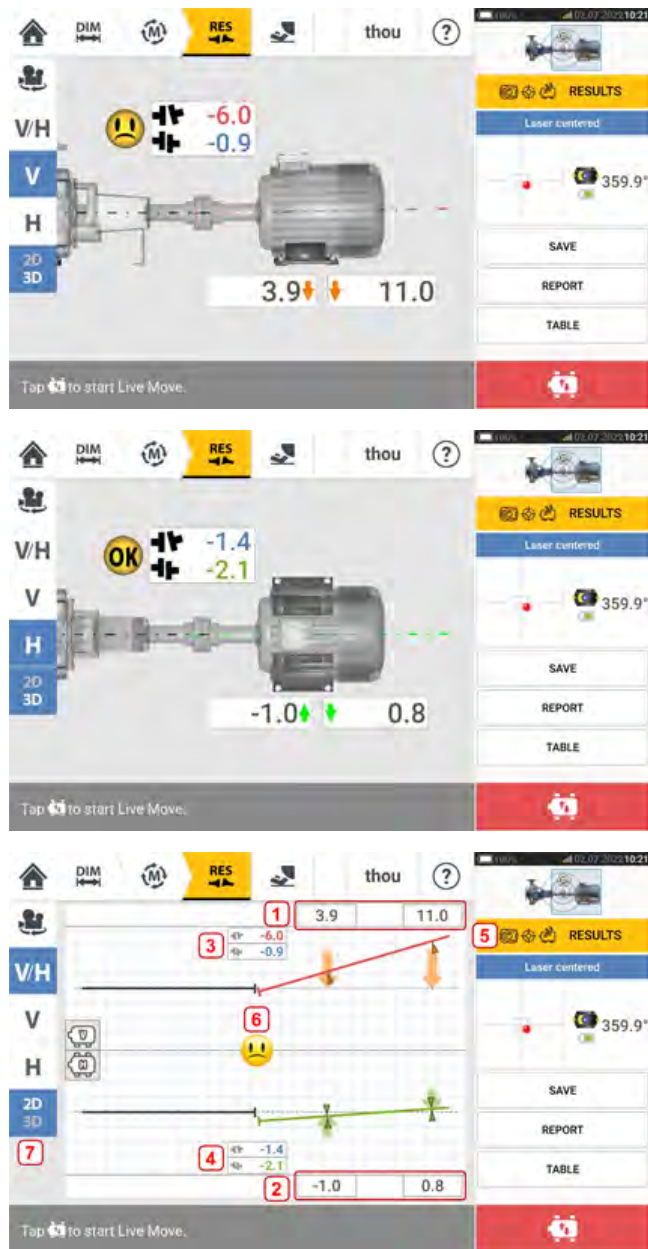

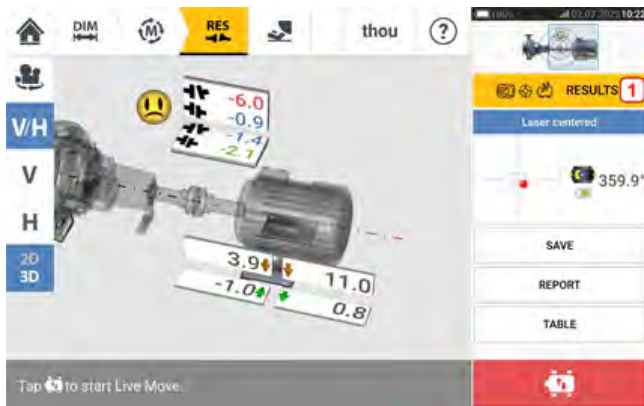

- **(1)** Vertical foot position results
- **(2)** Horizontal foot position results
- **(3)** Vertical coupling results
- **(4)** Horizontal coupling results
- **(5)** Selected results mode
- **(6)** Alignment condition tolerance symbol
- **(7)** Horizontal and Vertical foot and coupling results in 2-D

## Results options

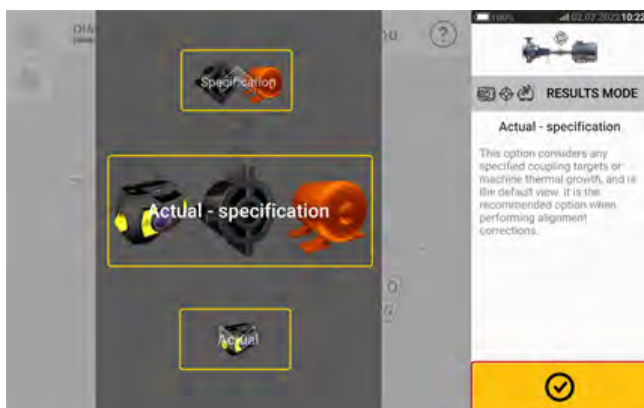

Alignment results may be displayed in three different options. To access the available options, tap **1**.



Use the results mode carousel to select the desired results option then tap  to confirm selection.

These options are available:

- 'Actual' – used to show just the measured alignment values without regard to any target values or thermal growth values that have been entered, even if they are active
- 'Specification' – shows just the effect of any target specifications and/or thermal growth values that may have been entered and activated, from a baseline of zero, without regard to any measured misalignment
- 'Actual minus Specification' – this option considers any specified coupling targets or machine thermal growth, and is the default view. It is the option that should be used when alignment corrections are done.

## Sign convention

Coupling gap is positive when open at top or side away from viewer. The viewer is considered to stand in front of the machines as they appear on the display.

Offset is positive when the right shaft axis is higher than the left shaft axis or further away from the viewer than the left axis.

Both vertical and horizontal results show the foot position relative to the centerline of machine designated stationary. Positive values indicate that machine is upwards or away from viewer. Negative values indicate that machine is downwards or towards the viewer.

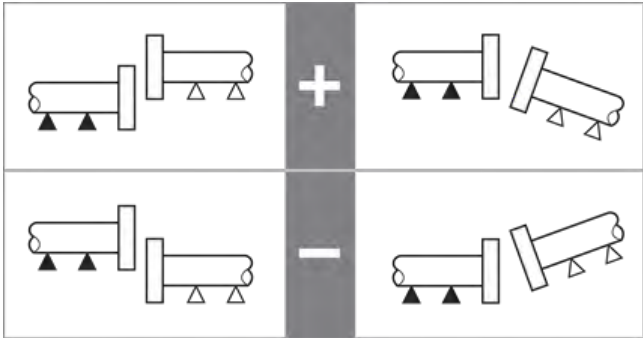

## Multiple feet results

### Foot corrections

Foot corrections in a multiple feet machine are viewed from the result screen.

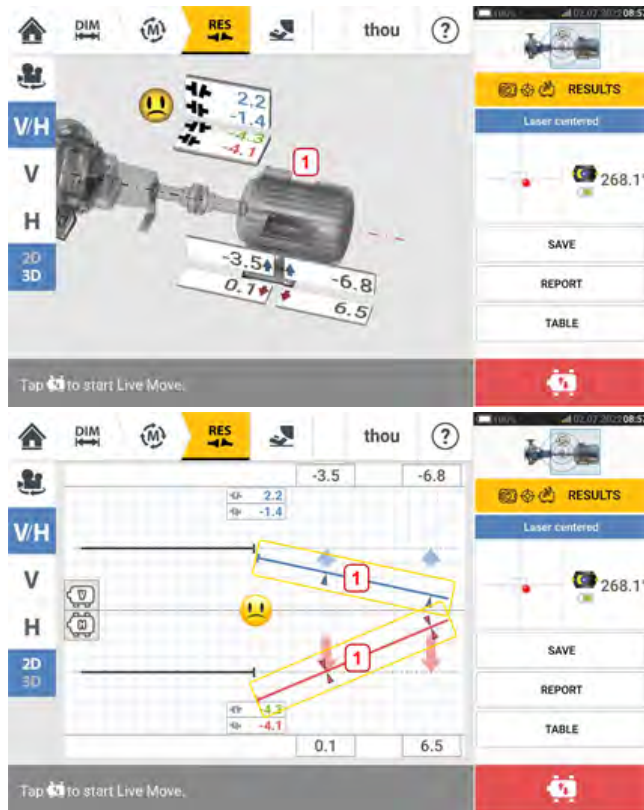

If results are displayed in 3D, tap the machine (1) to access the results multiple feet screen. In 2D, tap the machine centerline (1) to open the multiple feet screen.



**Note**

If the machine intermediate feet were already defined within machine properties, then the foot corrections for the intermediate feet will be displayed. In this example, the intermediate feet have not been defined.



Tap  to add any intermediate feet.



Enter the dimension between the front feet and the intermediate feet in the row that appears then tap .



The foot correction values for the intermediate feet appear in the related row.

## Live Move screen



### Note

Machines are aligned by vertical movement which involves the addition or removal of shims at the machine feet, and horizontal movement, where machines are shifted side-ways.

If the alignment condition of the machines is within tolerance (indicated by 😊 or OK) then there is no need to align the machines.



It is recommended to perform vertical corrections first, since the horizontal condition is easily affected when anchor bolts are loosened and shims inserted and/or removed, whereas the vertical condition is less prone to being affected when horizontal moves are performed.

Check soft foot before you proceed.

Live Move is monitored in either the horizontal (H) or vertical (V) plane.

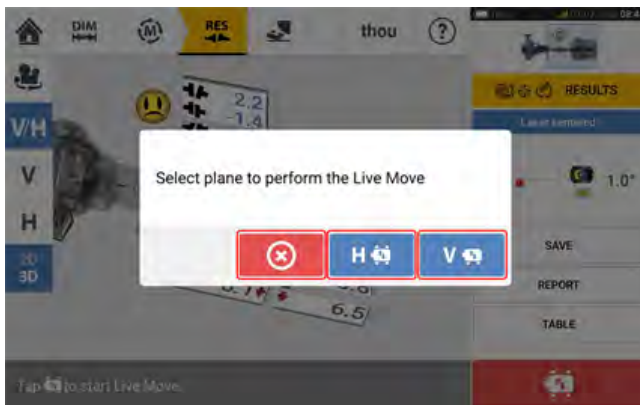
While in the results screen tap  to prompt Live Move. A hint to select desired Live Move plane appears.



- Tap  to shim
- Tap  to move machine sideways
- Tap  to cancel Live Move

If Active Clock is the measurement mode used, the next screen appears.

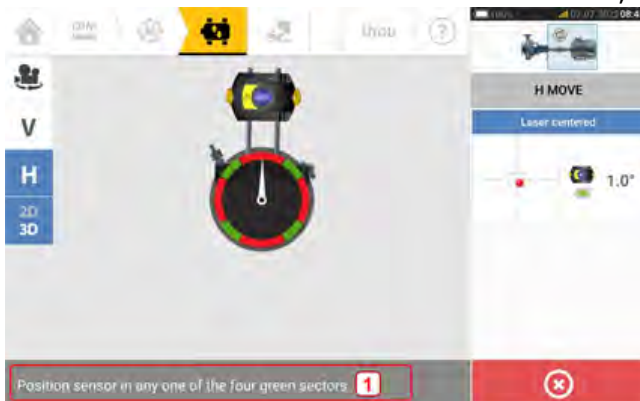



The screen prompts sensor and reflector to be positioned in any one of the four designated 30° sectors.

In Static measurement mode, four 45° positions (10:30, 1:30, 4:30 and 7:30 o'clock position as viewed towards the sensor) are available.



In Active Clock, the Live Move screen appears if the laser has been centered and the shafts are rotated to any one of the four sectors.

In Static measurement mode, use  and  to place the displayed sensor at the desired 45° position. This position corresponds to the actual angular position of the sensor and reflector on the shafts. Tap  to confirm position. If the laser beam is centered, the Live Move screen appears.

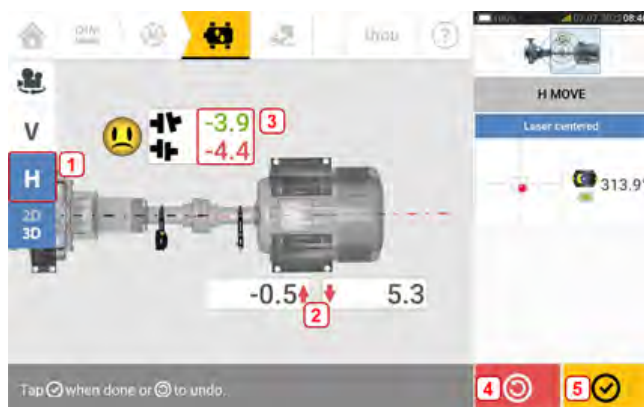

- **(1)** The selected Live Move plane (in this example 'H' – horizontal)
- **(2)** Arrows indicate direction and magnitude to move machine feet
- **(3)** Tolerance coded gap and offset coupling values
- **(4)** Tap 'Undo' icon to re-measure or start Live Move again.
- **(5)** Tap 'Proceed' icon to re-measure or start Live Move again

Once Live Move has been detected, the 'Cancel' icon  replaces the 'Undo' icon .



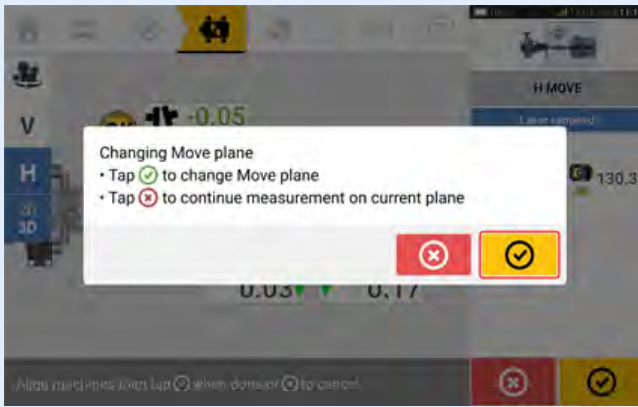

#### Note

To change the Live Move plane, tap the desired plane (in this example 'V' – vertical). A hint appears requiring confirmation on whether to change plane or proceed with Live Move in present plane.



Tap  to confirm changing Live Move planes. The sensor- reflector position selection screen appears. Proceed to position the displayed sensor as described previously.

Loosen the anchor bolts. Move the machine feet in the direction of the color coded bold arrows to correct the alignment condition. Keep an eye on the smiley on the display screen. The color coded bold arrows signify the attained coupling tolerance as follows: Blue (excellent condition); Green (acceptable condition) and Red (poor condition). The color of the arrows changes with the movements automatically. Watch the display screen carefully to ensure that machine end and direction moved are correct. The smiley on the display screen gives an indication of the alignment status as the machine is moved.



Machines should be moved to within acceptable tolerances () or excellent tolerances () while observing shaft alignment best practices.



**CAUTION**

Do NOT attempt to move the machine using heavy sledgehammer blows. This can cause bearing damage, and also produce inaccurate Live Move results. Jack bolts on the feet or other mechanical or hydraulic devices are recommended to move machines.



- (1) Tap  the 'Cancel' icon to prompt the 'Cancel Move' hint.
- (2) Tap  the 'Proceed' icon to start Live Move again or to remeasure the machines.

If the laser beam is centered, tap  to start Live Move automatically.



If the laser beam is not centered, use the laser beam adjustment wizard, or use the XY view screen to center the laser dot.

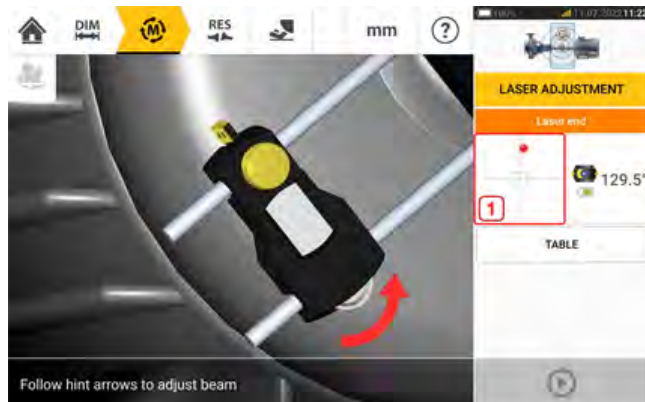

Tap the detector area on the screen [1] to access the XY View.



#### Note

If the vertical view (V) is selected when the function Live Move function is started, only the vertical condition will be displayed. Likewise, if the horizontal view (H) is selected, then only the horizontal condition will be displayed.

After machines have been moved to within tolerance, tighten the foot bolts then tap .



Tap  to remeasure and verify the Live Move results, and confirm new alignment condition.

## Save asset measurements

### Save an asset

Before the device is switched off, dimensions, measurements, results and all settings can be saved for analysis, future use or record purposes in the device internal memory or transferred through Cloud or USB to ARC 4.0 the PC software. Asset measurements are saved from the results screen.

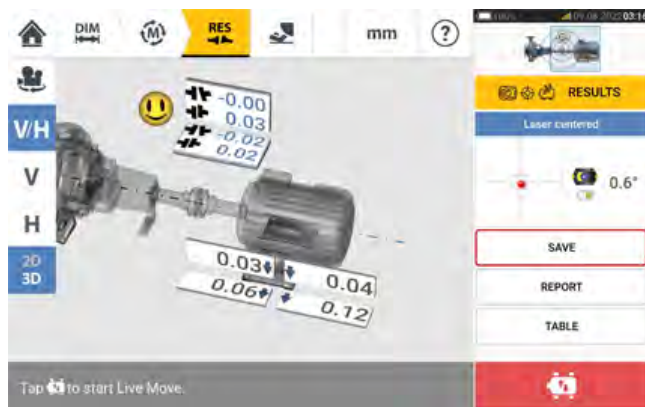

To save an asset measurement, tap the menu item "Save" then use the onscreen keyboard to enter the measurement file name.

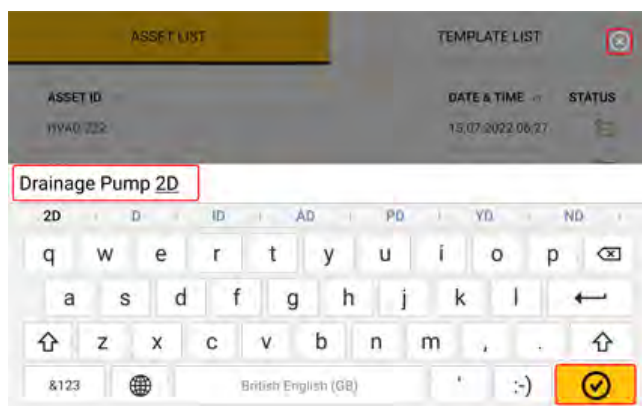

Once asset name has been entered, tap  to save the asset under "Asset park". This is the location where asset measurements are saved.



#### Note

If for any given reason, the asset is not to be saved, tap the cancel icon [] to cancel.

Asset refers to machinery and equipment within a plant. The asset is listed as an Asset ID. Access "Asset park" through the home screen.

ASSET LIST		TEMPLATE LIST
ASSET ID	DATE & TIME	STATUS
Drainage Pump 2D	09.08.2022 03:17	
Tower 2B	09.08.2022 03:13	
Update	05.08.2022 10:14	
S221	04.08.2022 03:15	
Drainage Pump 255	25.07.2022 07:19	
Static Feet	25.07.2022 04:00	

The status envelopes indicate whether an asset has been measured or not.

- This icon shows that the asset has been imported from ARC 4.0 but is yet to be opened.
- This icon shows that the asset has been opened but the alignment measurement has not been completed.
- This icon shows that the alignment measurement has been completed.

### Asset list options

ASSET LIST		TEMPLATE LIST
ASSET ID	DATE & TIME	STATUS
Drainage Pump 2D	09.08.2022 03:17	
Tower 2B	09.08.2022 03:13	
Update	05.08.2022 10:14	
S221	04.08.2022 03:15	
Drainage Pump 255	25.07.2022 07:19	

1 2 3 4 5 6

7 8

These actions are taken on any selected asset when the related icon is tapped:

- (1)** Uploads the selected asset to the cloud. Note: The action is completed only if wireless connection is enabled.

ASSET LIST		TEMPLATE LIST
ASSET ID	DATE & TIME	STATUS
Drainage Pump 2D	09.08.2022 03:17	
Tower 2B	09.08.2022 03:13	
Update	Finished - Drainage Pump 02 uploaded to cloud.	
S221	04.08.2022 03:15	
Drainage Pump 255	25.07.2022 07:19	
Static Feet	25.07.2022 04:00	

- **(2)** Assigns selected asset to an RFID tag.



- **(3)** Opens the selected asset as a new asset. The new asset will be a copy of the selected asset without the sensor-to-reflector dimension, and any asset measurements.



Tap related icon from the home screen to start required application. The new asset opens and may be edited as required.

Assets opened in this manner are used as templates. This asset is then saved with a new asset name.

- **(4)** Used to edit directly the name of the selected asset.

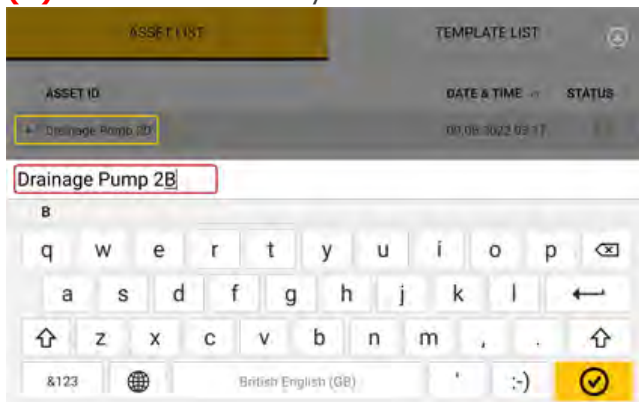

Once completed, tap . The asset will now appear in the asset list with the new name.

- **(5)** Used to create a template.  
A template is a file that serves as a pattern for alignment set-ups that are repeated frequently. Their main purpose is to save time by not having to reconfigure the same set-up many times. It can contain all known dimensions (except sensor-to-reflector), target specifications, thermal growth values, tolerances, preferred measure mode, preferred machine icons and coupling types.  
> After an asset has been created and saved, it appears on the asset list.

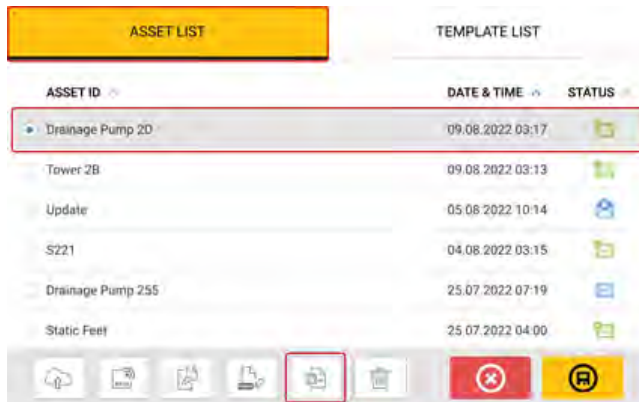

> Tap  to save the asset as a template.

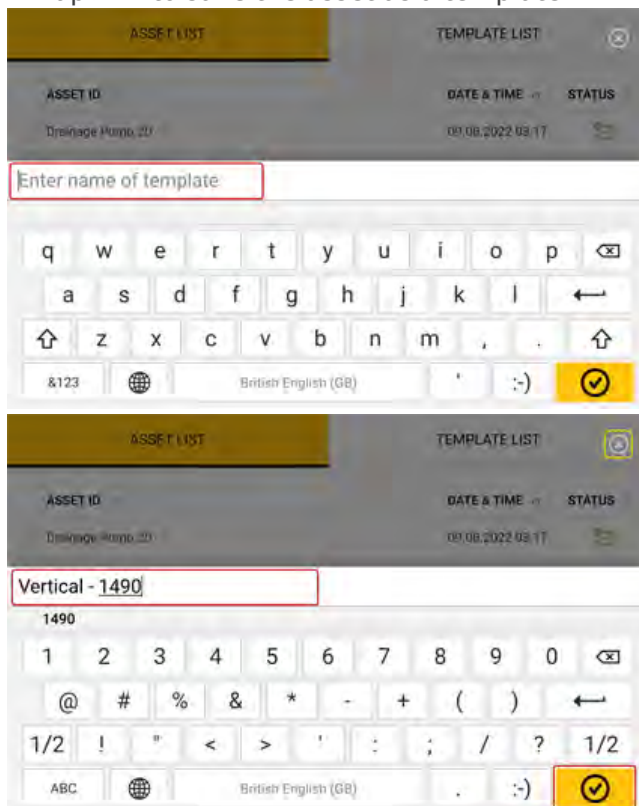

> Enter name of template then tap .





### Note

If for any given reason, the template is not to be saved, tap the cancel icon [] to cancel saving.

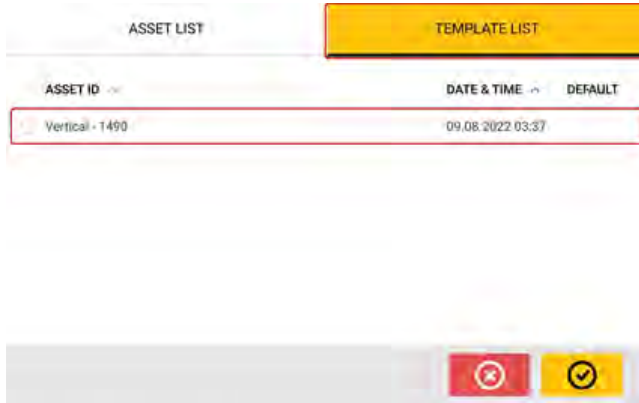
> The created template now appears on the template list.



- **(6)** Used to delete selected asset.
- **(7)** Used to exit the asset list/template list screen and return to the home screen.
- **(8)** This symbol [  ] signifies that the selected asset is open and running in the background. The symbol serves the dual purpose of either opening the selected asset or saving any changes that may have been applied to the asset but not yet saved. If an asset that was previously saved but currently not open is selected, then the symbol  [ **9** ] appears.

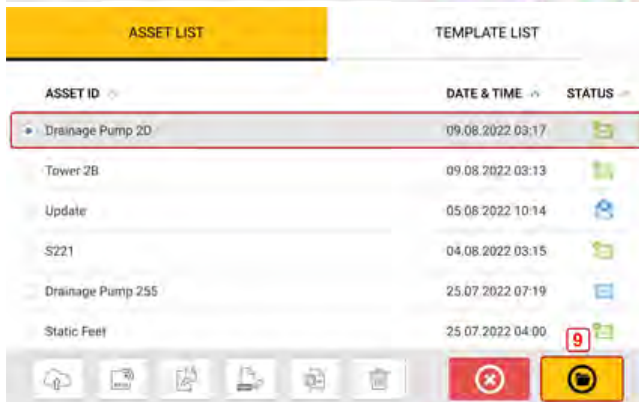
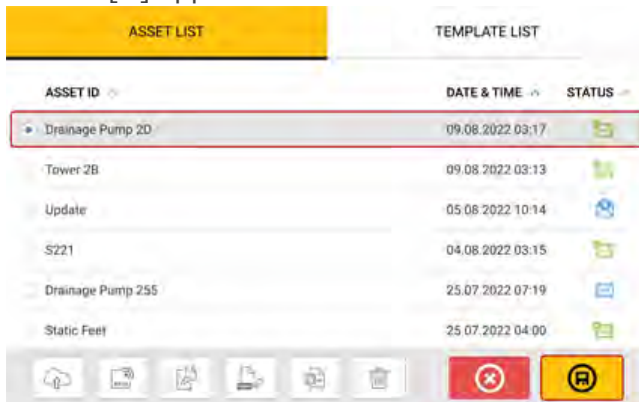

**Note**

If the selected asset has not been previously saved then all the asset list options (**1**) are inactive.

ASSET LIST	TEMPLATE LIST
ASSET ID ▾	DATE & TIME ▾ STATUS ▾
▶ Current asset: [New]	09.08.2022 03:45
Drainage Pump 2D	09.08.2022 03:17
Tower 2B	09.08.2022 03:13
Update	05.08.2022 10:14
S221	04.08.2022 03:15
Drainage Pump 255	25.07.2022 07:19



## Default template

It may be necessary to define any one template as the default template. The default template will be used whenever a new asset is opened within the home screen.

> All available templates are listed on the template list.

ASSET LIST	TEMPLATE LIST
ASSET ID ▾	DATE & TIME ▾ DEFAULT
▶ PM1	09.08.2022 03:46
Vertical - 1490	09.08.2022 03:37

> Select template to be designated as default, then tap  (1).

ASSET LIST	TEMPLATE LIST
ASSET ID ▾	DATE & TIME ▾ DEFAULT
▶ PM1	09.08.2022 03:46  
Vertical - 1490	09.08.2022 03:37

> The default template now appears on the template list with a check mark (1).

> To revert the default template to a normal template, tap  (2).

> **Note:** The designated default template cannot be deleted (3). To delete it, it must first be reverted to a normal template.

Note: If no template is selected, all template list options are unavailable.

ASSET LIST		TEMPLATE LIST	
ASSET ID		DATE & TIME	DEFAULT
Pumps		09.08.2022 03:48	
PM1		09.08.2022 03:46	
Vertical - 1490		09.08.2022 03:37	

--	--	--	--



## Generate reports

### Generate measurement reports

Asset measurement reports can be saved directly on the rugged device as PDF. Measurement reports are generated from the results screen.

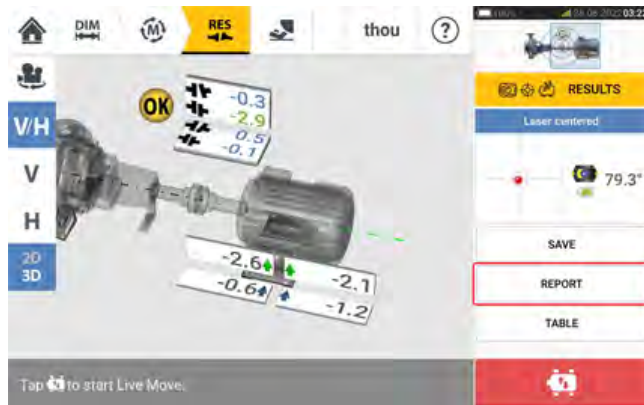

Tap the menu item "Report". The "Generating report" screen opens.



In this example, none of the "Generating report" menu items has been activated. To activate any of the items, tap the respective icon . When "Machine alignment information" is activated, useful machine related information may be entered.

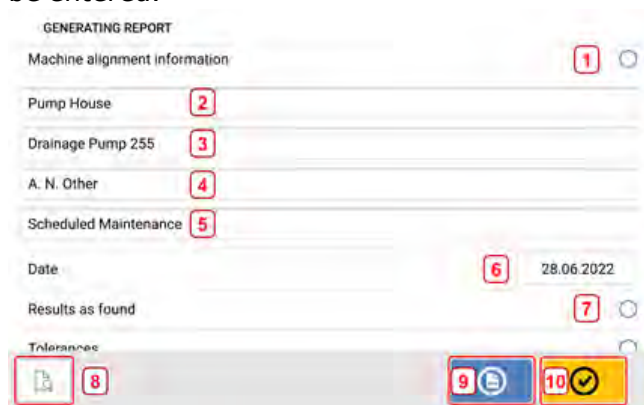



- **(1)** "Machine alignment information" activated

These machine related information may be entered once "Machine alignment information" has been activated:

- (2) Location where asset is positioned
- (3) Asset (Machine) ID (**Note**: asset ID appears only after the asset has been saved)
- (4) Name of operator
- (5) Any other machine relevant notes
- (6) Date is set automatically
- (7) In this case, "Results as found" has been activated

The following elements are also found on the "Generating report" screen.

- (8) Tap  to preview the asset measurement report
- (9) Tap  to save the asset measurement report as PDF to the rugged device.



The report as a PDF [1] is accessed when the device is connected to a PC. The report is saved in the folder "Reports" which is accessed through "Fluke831\T-ablet\Media\Reports".

-   
**Note**  
The generated PDF report saved together with the asset may also be accessed through the software platform ARC 4.0 in "Asset Attachments".

- (10) Tap  to save any information entered, and then exit the "Generating report" screen

## Report logo

The desired report logo must initially be saved within the rugged device before it can be added to the measurement report. These image formats are supported: png, bmp, jpg and jpeg

**Note**: To add a new logo to the report logo gallery is only possible if the item "Show report logo" is activated (1).



- With the rugged device connected to a PC and access allowed, save the desired logo in the folder "Logos" which is accessed through "Fluke831\Tablet\Media\Logos".



- Disconnect the rugged device from the PC and then tap the "Add report logo" icon

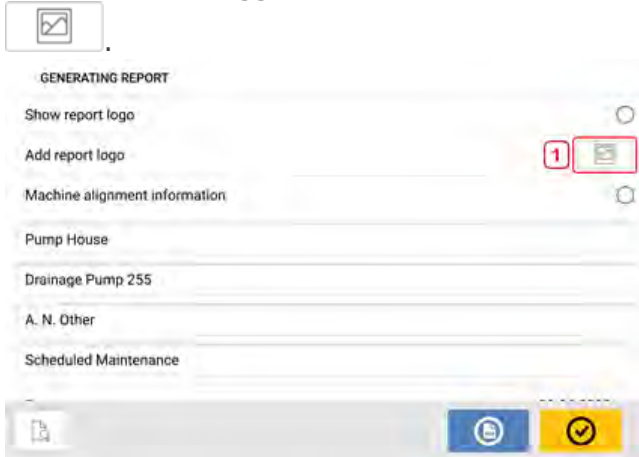

- The report logo gallery opens.

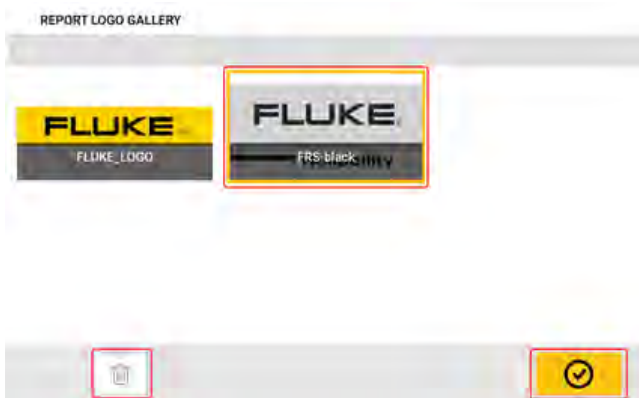

From the report logo gallery, tap the desired logo and then tap . The selected logo will now appear on the PDF measurement report when "Show report logo" is activated.

**Note:** The delete icon is active. In this case, the added logo can be deleted from the gallery.

## Save report to USB drive

Asset measurement reports may be saved as PDF to a USB drive. Measurement reports are generated from the results screen.



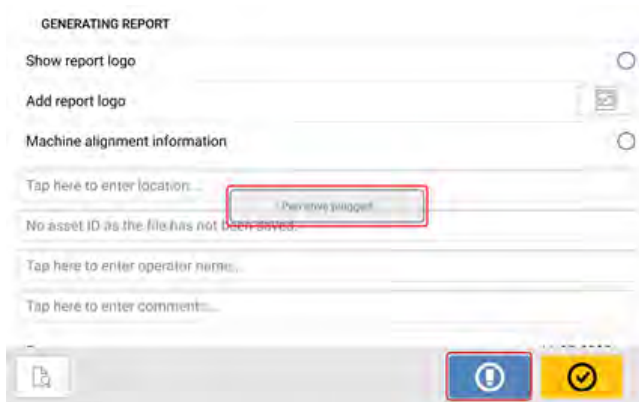

Connect the rugged device to a USB drive using the provided USB C to USB A adapter then tap the menu item "Report". The "Generating report" screen opens. The hint "Pen drive plugged" appears.

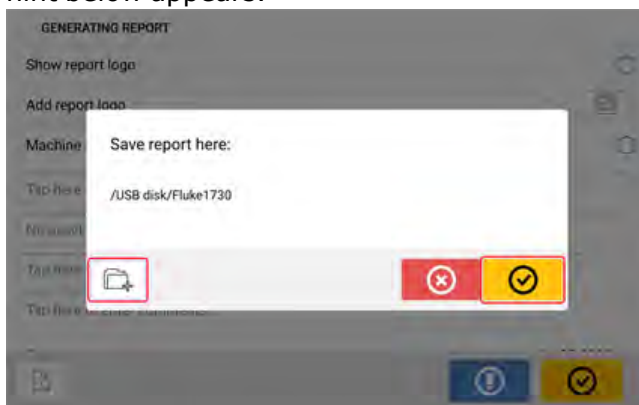

Tap .

If the USB drive had been previously used to save reports from the given rugged device, the hint below appears.



Tap  to confirm saving report in the suggested location. The report will then be saved in that location on the USB drive.

Optionally, the report may be saved in a different location on the USB drive by tapping . The folder location is then set as follows:

The first time a USB drive is connected to the rugged device to save a report, the following screen appears. This screen is used to determine the location to save the report.

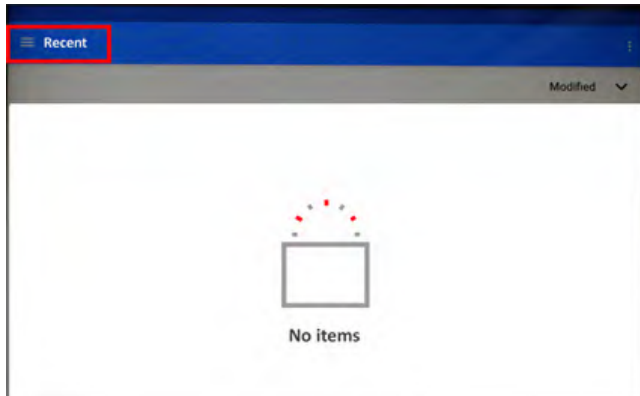

Tap the hamburger menu icon next to "Recent". Drop down menu items appear.

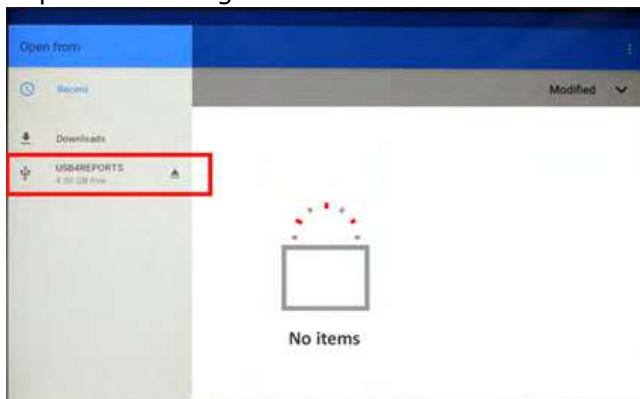

Tap the menu item corresponding to the connected USB drive (in this example "USB4REPORTS").

The files and folders in the connected USB drive will be displayed.

**Note:** The displayed folders may be created in advance from a PC.

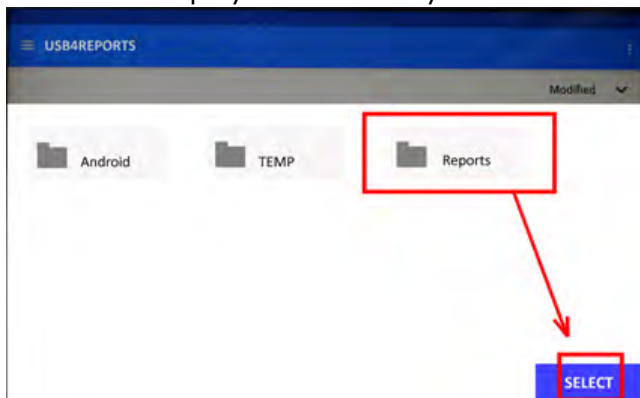

Tap the desired folder (in this example "Reports") followed by "Select". The report will be generated and stored in the selected folder.

**Note**

Wait until all corresponding hints to generating and saving report have been displayed before disconnecting the USB from the rugged device.

## What is soft foot

---

Soft foot is the condition of machine frame distortion. Any cause that results in machine frame distortion when the machine is anchored to its foundation is a soft foot. Some of the principal causes are:

- Non-coplanar machine mounting surfaces
- Deformed machine frame or feet
- External forces e.g. from connecting pipe or bracketry
- Improper shimming or soiled machine feet
- Too many shims under a machine foot (a maximum of 5 shims should not be exceeded)

The consequences of forcibly tightening down the feet are deformed machine frames, bent shafts and distorted bearings. This leads to high vibration and premature machinery failure.

Soft foot should be checked before aligning the shafts. This can be done quickly and conveniently with the aid of the soft foot function. With the sensor and reflector mounted on the shaft in the usual way, the system is able to sense any machine movement when the machine bolts are loosened individually. By entering the machine dimensions, the rugged device is able to calculate, from shaft movement, by how much each foot has moved as it is loosened. Once foot movements have been established, the results are interpreted and translated into shim thicknesses to be placed under the feet. How straightforward this is, depends on the type of soft foot present.

### Parallel soft foot

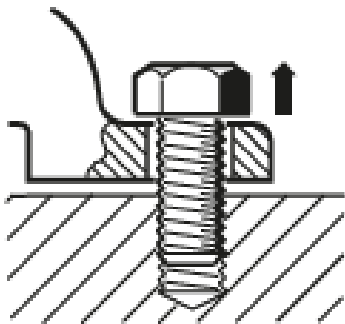

In parallel soft foot, one or more feet are too short or too long. This usually results in the machine rocking on the longer feet. This is corrected by shimming the shorter feet.

### Angular soft foot

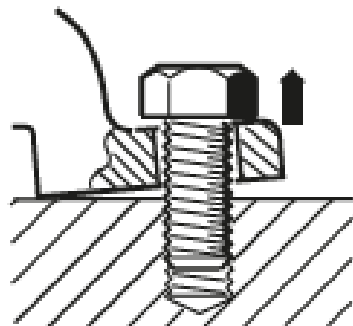

With angular soft foot, the base of the foot is at an angle to its foundation and they are only partly in contact. In this case, suspect foot is checked with a feeler gauge and corrected by building a custom 'shim wedge' or machining the underside of the foot.

### Checking and correcting soft foot conditions



The three main types are parallel soft foot, angular soft foot, and induced soft foot. There are instances where the soft foot is a combination of two or more types.

Checking for soft foot is part of machine and job preparation.

**Note**

The machine(s) to be checked is/are assumed to have four feet in an approximately square formation. If the machine has six feet, it is advisable to leave the middle feet loose and treat the machine as a four-footed machine. Soft foot is measured only on machine designated as movable.

## Soft foot

Soft foot measurement can be started from any screen where the 'Soft foot' icon [  ] is active. Tap  to start soft foot measurement. The values may be determined by sensor measurement or entered manually from values established using manual methods such as feeler gauges and shims.

All four foot bolts must be bolted down before starting measurement.

### Sensor measurement

Mount the components, enter all required dimensions, and then adjust the laser beam as required. (You may refer to Mount components, Dimensions, and Laser beam adjustment.) Swipe the blue button (1) to "Sensor". The laser beam must have the status "Laser centered" or "Laser OK".

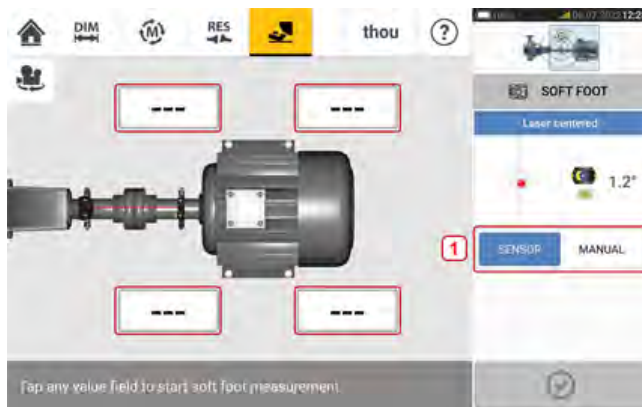

Tap any one of the four pulsating value fields to start soft foot measurement at the respective machine foot.

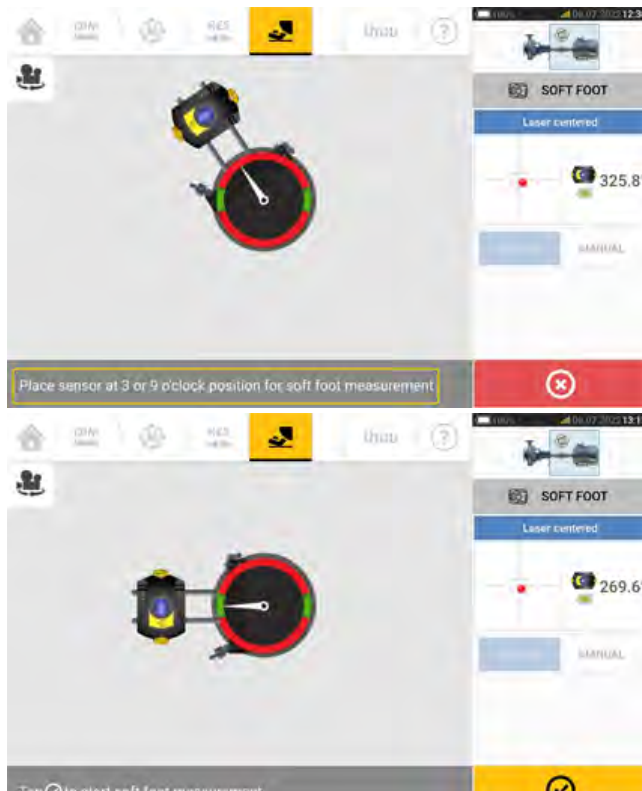

A hint appears to indicate that the shafts should be rotated to position the sensor and reflector at either the 3:00 or 9:00 o'clock position.





Once the sensor and reflector have been positioned horizontally, the on-screen needle rests on the respective green sector, and the following adjustment screen appears.



Loosen the related foot bolt (see hint **1**). The recorded soft foot value is displayed [**2**]. When the soft foot value stabilizes, tap  the 'Proceed' icon or recorded value (**2**), then tighten the bolt (see hint **1**). If necessary, tap  the 'Cancel' icon to cancel the soft foot measurement at the related foot. The above soft foot measurement procedure is repeated for all four feet positions.



The smiley indicates the soft foot condition. A happy smiley indicates that the measured soft foot is within tolerance and further corrections are not necessary. Acceptable soft foot tolerance is 0.05 mm (2 mil). A sad smiley indicates that the measured soft foot is out of tolerance and corrections are necessary.



#### Note

Tap the smiley within the machine to view the set soft foot tolerance.

If the shafts rotate away from the 3:00 or 9:00 o'clock position while soft foot is measured, this hint screen is shown.

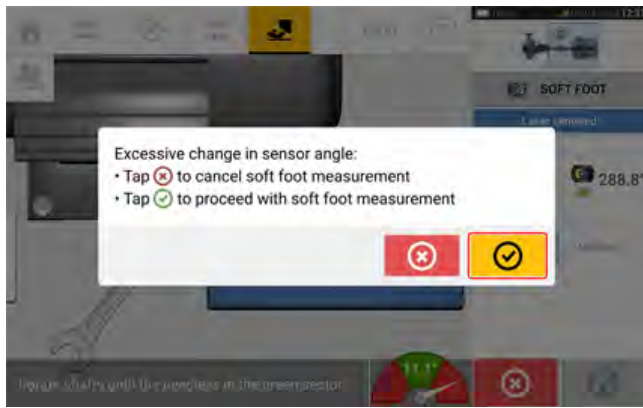

To proceed with soft foot measurement, tap . The next screen is shown.



Rotate the shafts to position the sensor and reflector at the correct angular position. Use the on-screen needle [1] as guidance. The needle should rest on the green sector.

## Manual entry

Manual values may be determined using feeler gauges. Four points around the bolt point are measured with feeler gauges. The calculated values are then entered in the soft foot application.

Manual values do not require use of either sensor or reflector.

Swipe the blue button to "Manual". Manual entries are signified by the finger icon on the display.

Tap any one of the four pulsating value fields then proceed to enter the soft foot value at the respective machine foot. Use the onscreen keyboard.

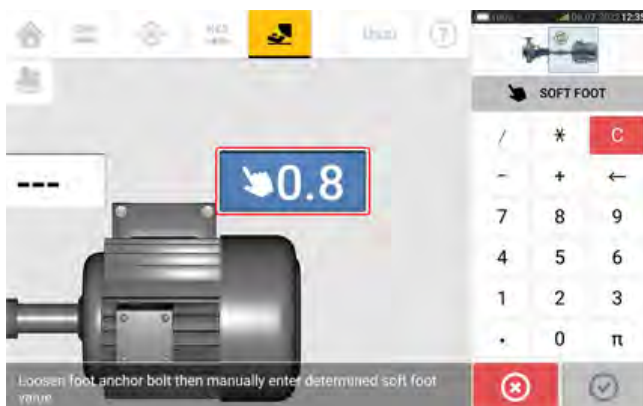

Repeat the procedure for all four feet positions.

The tolerance smiley will determine whether the soft foot requires correction or not.

## Vertical flanged machines

A typical vertical machine arrangement comprises one machine mounted on top of the other with a bolted flange.

Flange-mounted machines may have a vertical or horizontal orientation. In either case, alignment corrections are made directly at the flange.

Insert or remove shims between the flanges to correct angularity. The rugged device calculates shim thickness for each flange bolt.

Position the flange laterally to positioning the flange laterally to correct offset.

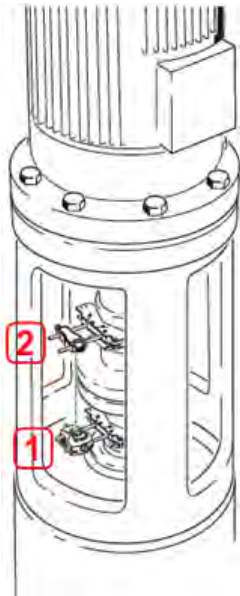

- **(1)** Sensor
- **(2)** Reflector (prism)

The sensor and reflector are mounted on either side of the coupling, in the same way as for horizontal machines. The sensor is mounted on the shaft of the bottom machine, and the reflector on the shaft of the upper machine. As the electronic inclinometer cannot directly determine the rotation angle of vertical shafts, the measurement mode for vertical machines is Static Clock.

### Mark measurement positions

For Static Clock measurement mode, the eight 45° measurement positions used with these procedures must be marked correctly on the machine.

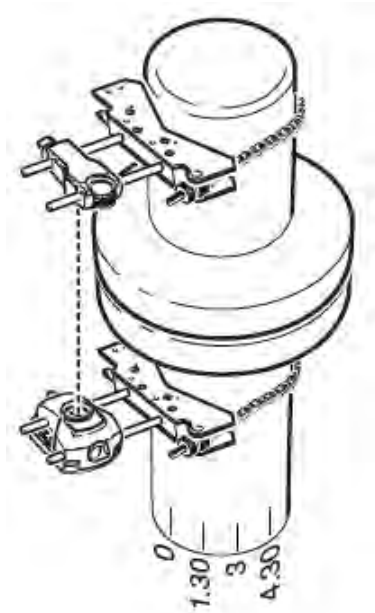

- Mark a reference position on the machine close to the shaft and in line with a convenient external reference or flange bolt. Likewise, mark a reference point on the shaft.
- Measure the circumference of the shaft and divide by eight.
- Use this distance to make seven more evenly-spaced marks on the shaft. Begin at your chosen start point. Number the points counterclockwise as seen from sensor to reflector. Begin with 0 first, followed by 1:30, 3:00, 4:30, 6:00, 7:30, 9:00 and 10:30.

For circular housings, measure the circumference of the machine coupling housing and divide by eight. Use this distance to make eight evenly-spaced marks on the housing. Begin at your chosen start point. Number the points clockwise looking down onto the shaft with 0 as the first, followed by 1:30, 3:00, 4:30, 6:00, 7:30, 9:00 and 10:30.

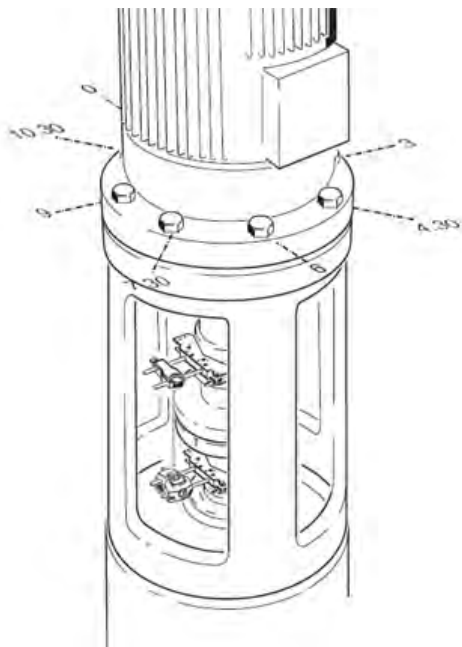

## Set-up

- Mount the sensor and the reflector on either side of the coupling. Make sure that sensor and reflector are aligned with the 0 or reference mark.
- Switch the touch device on, then tap  in the home screen to start the vertical alignment application.

Note: If the icon is inactive, tap  to activate the vertical alignment icon.

- Use the machine carousel to configure the machines as required (refer to Machine properties).
- Enter these required machine dimensions:

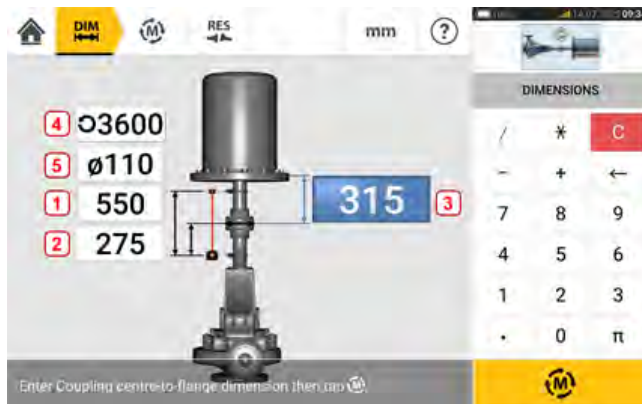

- **(1)** Sensor to reflector
  - **(2)** Sensor to coupling center — This dimension is calculated as half the sensor-to-reflector distance automatically. The dimension may be edited as required.
  - **(3)** Coupling center to flange
  - **(4)** RPM
  - **(5)** Coupling diameter
- The flange geometry must be taken into account when machine dimensions are entered. Tap the flange-mounted machine.

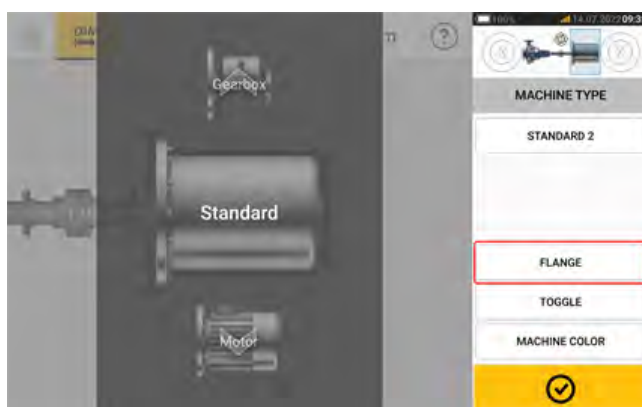

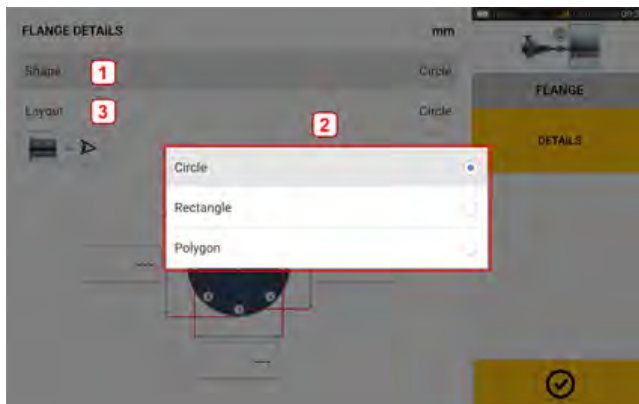

The menu items on the screen are used to edit machine name, access the "Flange details" screen, change the flange position with respect to the shaft, flip the machine along the shaft axis (toggle) and edit machine color.

- Tap 'Flange' to access the "Flange details" screen where the flange may be edited.

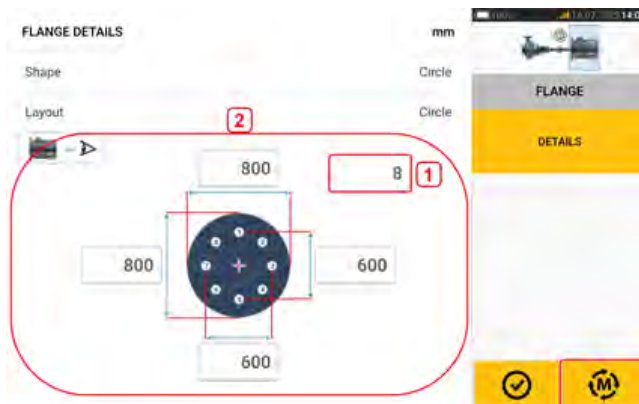

- Tap the 'Shape' area [1] to select the shape of the flange from the pop-up menu [2] that appears. In the above example, the selected shape of the flange is "Circle".
- Tap the 'Layout' area [3] to select the pattern formed by the bolts from the pop-up menu that appears.
- Tap the respective value boxes then use the onscreen keyboard to enter flange dimensions and bolt pattern lengths. To edit number of bolts, tap [1] then enter the value directly. After dimensions have been entered, tap the displayed flange area [2] to close the onscreen keyboard.



- After all the required dimensions have been entered, tap  to proceed to measure.

This measurement procedure is used for vertical flanged machines:

"Vertical flanged machines – Static clock" on page 103

## Vertical flanged machines – Static clock

### Use Static measurement mode

- Center the laser beam.





#### Note

Static measurement mode is used for vertically mounted machines.

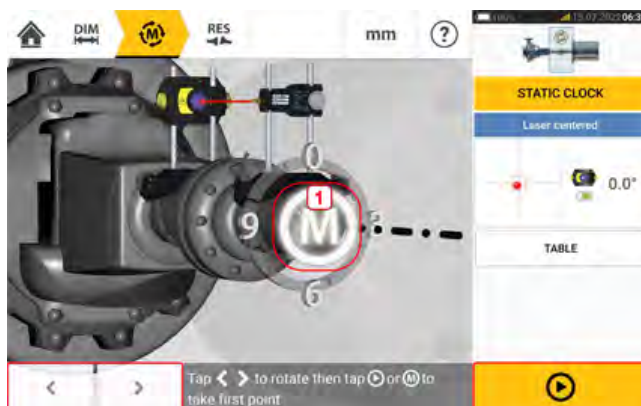
- Rotate the shafts to the first measurement position. If the coupling housing numbering convention is used, the reference mark on the housing and the measurement position 0 must be aligned.



- Use  or  to position the displayed sensor and reflector at the same rotational position as the actual components mounted on the shafts, then tap **M [1]** or  to take the first measurement point.
- Rotate shaft to the second measurement position (e.g. 1:30). If the chosen measurement position does not correspond to the angle selected automatically on the display, use the navigation keys to manually position the sensor and reflector at correct position on the display.

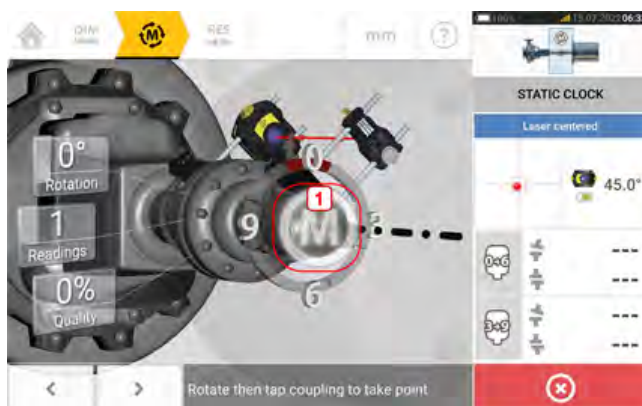

Tap **M [1]** to take measurement point.



- Take the maximum number of measurement points to maximize the quality of results.

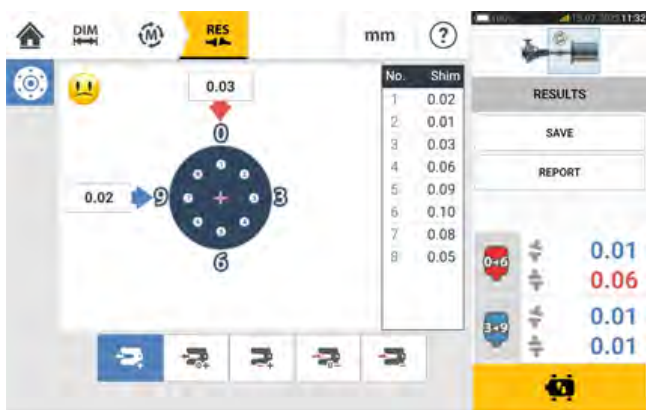

- Tap  to view correction values.



**Note**

If flange dimensions have not been defined, the flange icon  is shown in the results screen. Tap  and enter missing flange dimensions.



## Vertical results



- **(1)** Flange correction in 0-6 direction
- **(2)** Flange correction in 3-9 direction
- **(3)** Bolt position
- **(4)** Shimming values
- **(5)** Coupling gap and offset in the 0-6 direction
- **(6)** Coupling gap and offset in the 3-9 direction
- **(7)** Shim correction modes
- **(8)** Shim correction mode used in this example
- **(9)** Initiates Live Move
- **(10)** Tap the coupling results area to open the measurement table screen.

In the results screen, the three icons    – dimensions, measurement and results – are active and may be used anytime.

## Shimming modes

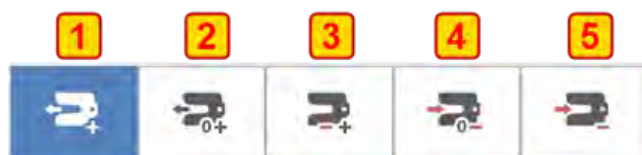

Shimming modes are defined as follows:

- **(1)** mode indicates all positive shimming
- **(2)** mode indicates "zero/plus" shimming. In this mode, one bolt position is set to zero and the rest are positive
- **(3)** mode indicates optimized shimming. In this mode, half of the corrections will positive, and the other half negative.
- **(4)** mode indicates "zero/minus" shimming. In this mode, one bolt position is set to zero and the rest are negative.
- **(5)** mode indicates all negative shimming

## Sign convention

POSITIVE GAP opens towards 0:00 or 3:00

POSITIVE OFFSET if the top Coupling half is offset towards 0:00 or 3:00

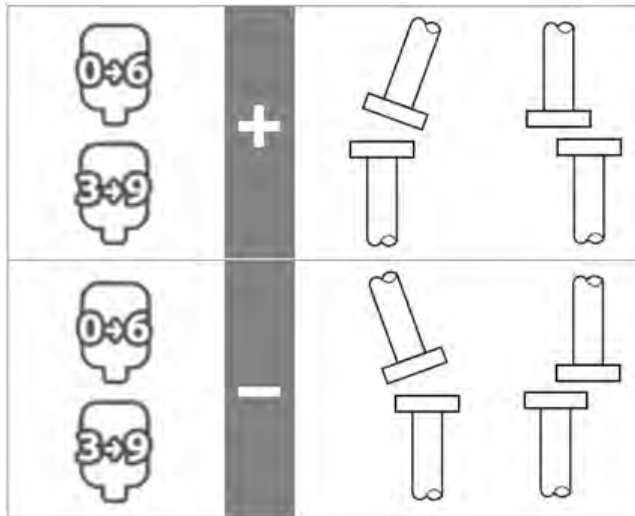

Viewpoint is always determined by looking from the reflector towards the sensor.  
Note: The little clock face on the sensor serves as a reminder of the viewpoint.



**WARNING**

When the sensor is switched on, the laser beam is emitted. DO NOT stare into the laser beam!

## Live Move – Vertical machines

Alignment is carried out by correcting angularity and offset.

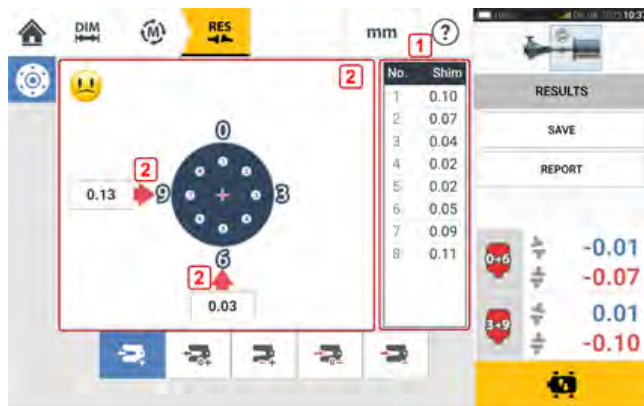

- **(1)** Shim at the given bolt locations to correct angularity.
- **(2)** Move the machine laterally to correct offset.

### Correct angularity

We recommend (but not obligatory) angularity corrected first:

1. Loosen the flange bolts then lift the movable machine.



#### **WARNING**

The machine bolts must be undamaged and removable.

2. Angularity corrections are made by shimming. The shimming values at the respective bolt positions are shown on the screen. Insert (or remove) shims with the correct thickness under the selected bolt. Loosen the flange bolts then lift the movable machine.
3. Tighten the bolts back down, then take another set of readings to confirm shimming corrections; repeat shimming if necessary.
4. Once satisfied that overall angular misalignment is in tolerance, and no more shimming is required, proceed to correct offset.

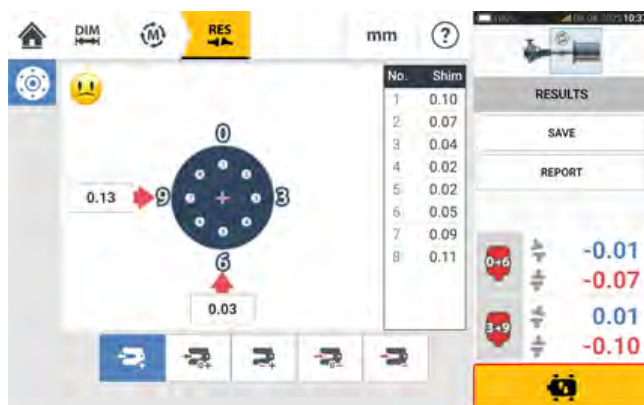

### Correct offset

1. Use the Live Move function to make offset corrections.



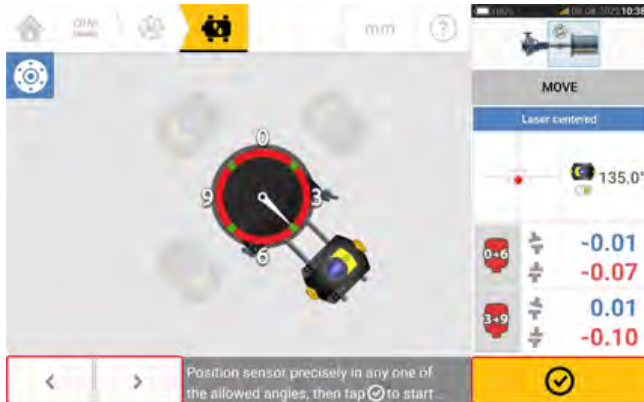

2. Tap  to start Live Move. A hint screen prompting the positioning of the sensor and reflector in any one of the four designated 45° positions (10:30, 1:30, 4:30 and 7:30 o'clock position – as viewed towards the sensor) appears.

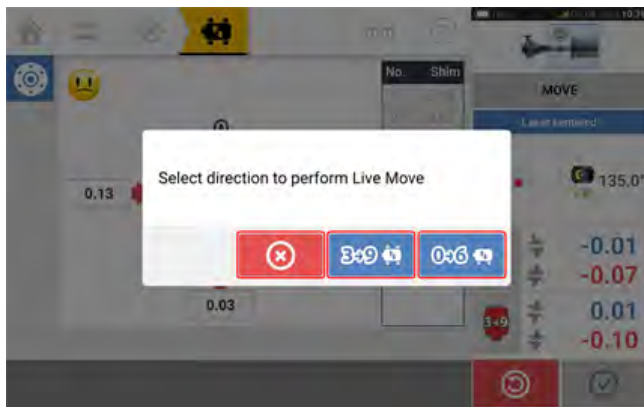

3. Use  and  to place the displayed sensor at the desired 45° position. This position corresponds to the actual angular position of the sensor and reflector on the shafts. Tap  to confirm position. A hint to select desired Live Move direction appears.



- Tap  to perform offset corrections in the 3 to 9 direction
- Tap  to perform offset corrections in the 0 to 6 direction
- Tap  to cancel Live Move

4. If the laser beam is centered, the Live Move screen appears.







- **(1)** The selected Live Move direction (in this example 3 to 9)
- **(2)** Arrows indicate direction and magnitude to move machine
- **(3)** Tolerance coded gap and offset coupling values
- **(4)** Tap the 'Undo' icon to re-measure or start Live Move again.
- **(5)** Tap the 'Proceed' icon to re-measure or start Live Move again.

5. Loosen the flange bolts then move the machine laterally in the direction of the color coded bold arrow **(1)** to perform offset corrections. The color coded bold arrow signifies the attained coupling tolerance as follows: Blue (excellent condition); Green (good condition) and Red (poor condition). The color of the arrows changes with the movements automatically. Monitor the arrows on the Live Move screen.



- Corrections should be brought as close as possible to zero.
- Use appropriate tools (e.g. jackscrews) to position the machine.
- Take care not to let the shims slip out of place during lateral positioning.

Once Live Move has been detected, the 'Cancel' icon  replaces the 'Undo' icon . After moving the machine to within acceptable tolerance (indicated by the color coded bold arrow) tap  to proceed to carry out offset corrections in the next direction (in this case the 0 to 6 direction).

Tap  the 'Cancel' icon to see the 'Cancel Move' hint.

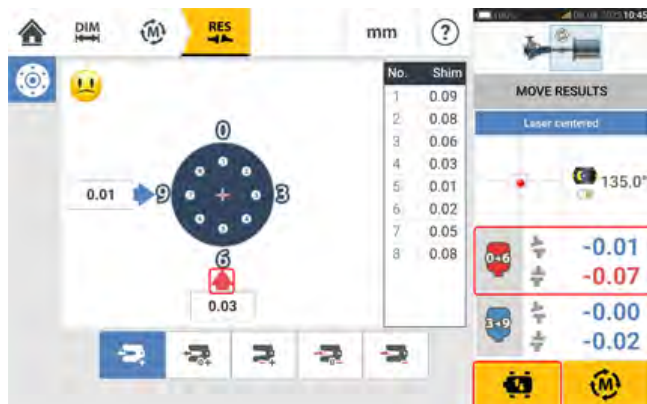

6. Tap  to change the offset correction direction. Repeat steps 2-5 ("Correcting offset").

7. When offset is in tolerance as indicated by a happy smiley [ 😊 ] (excellent tolerance) or an OK icon [ OK ] (acceptable tolerance), tighten the flange bolts then tap [ M ] to remeasure and check to confirm if the new alignment condition is in tolerance.
8. If not, repeat the above steps until alignment is in tolerance.

## sensALIGN 3 sensor firmware update

### Update sensor firmware to a newer version

It is possible to carry out a sensor firmware update directly through the rugged touch device. If a sensor with an older firmware version is connected through Bluetooth to the rugged device, a sensor firmware update notification appears on the display.

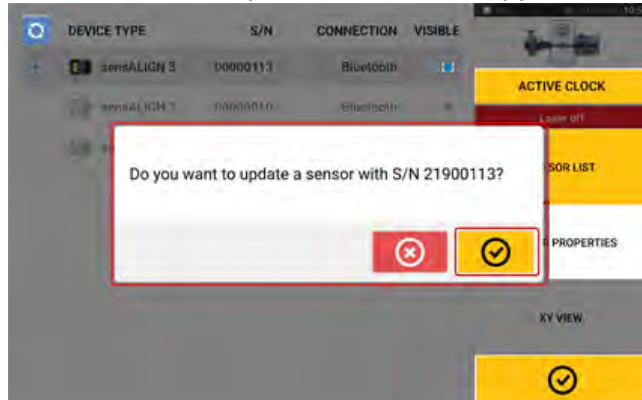

It is recommended to update the sensor firmware. Tap  to proceed to update the sensor. The following sensor firmware update screen appears.



The screen shows that a newer sensor firmware version is available within the rugged touch device. Tap  to update the sensor connected through Bluetooth.

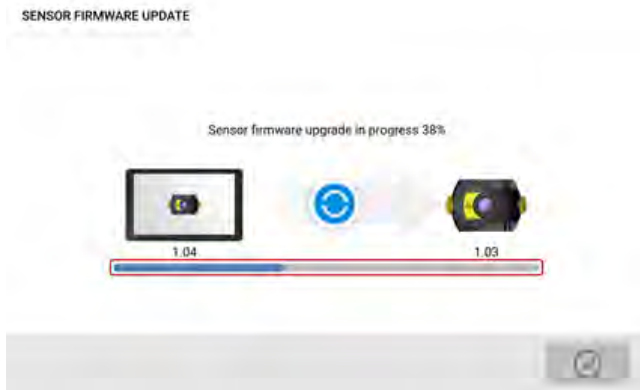

Once the update process is successfully completed, the following screen appears.



The sensor has now been updated to the newer version available on the rugged touch device.

Tap  to exit the update screen.

The new sensor firmware version is shown in "Sensor properties". Tap the sensor area **(1)** in the measurement screen to see sensor properties.



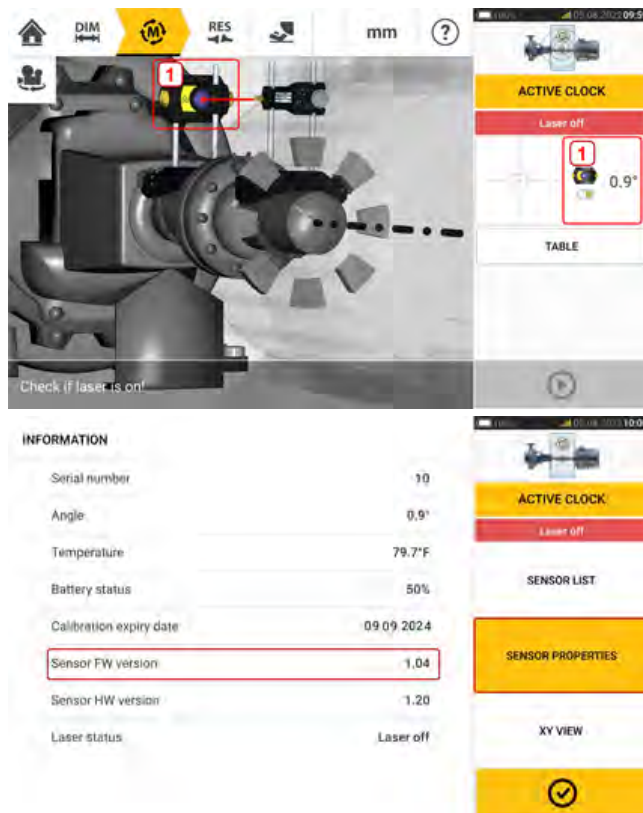

If the sensor firmware update is not carried out when the notification appears, the update action may be initiated through "Sensor properties". An "UPDATE" hint appears next to the older sensor firmware version.

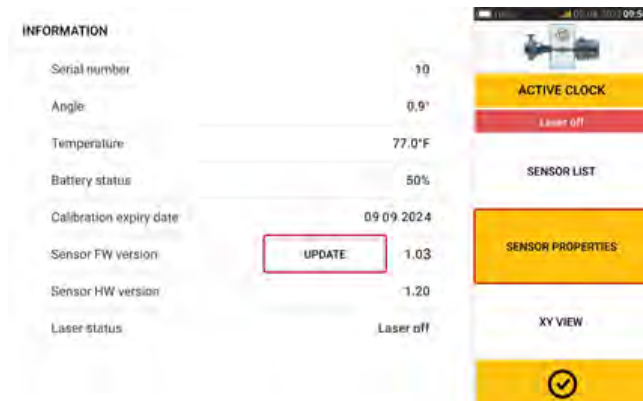

Tap "UPDATE" to proceed with the sensor firmware update.



### Note

The sensor firmware update notification continues to appear once everyday until the firmware update is completed.

## Notification on sensor calibration



### Note

The calibration accuracy of the sensor should be checked every two years as indicated

on the round label affixed to the back of the sensor.  
The sensor should be returned to an approved technical site for calibration check.



**Note**

The calibration due date is also found under "Sensor properties".

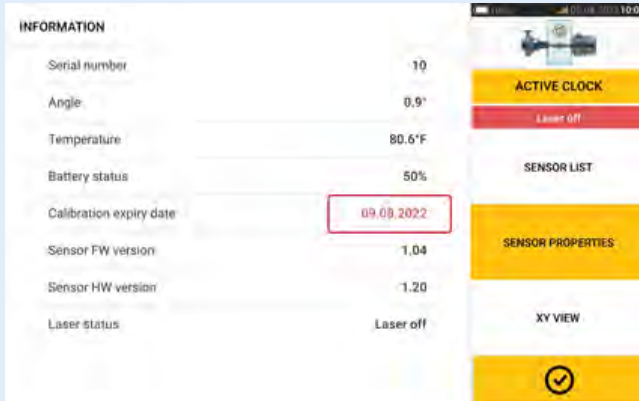

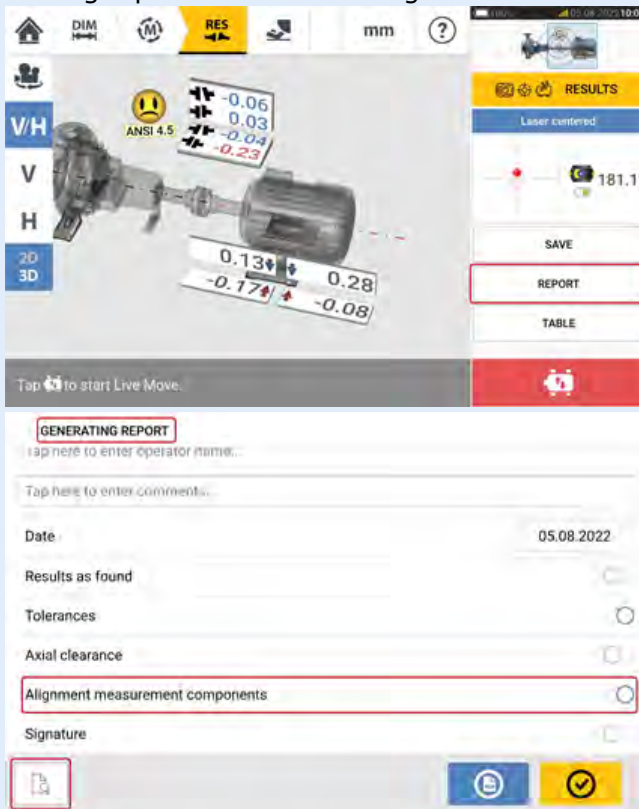

If the calibration due date has expired, the due date will be highlighted red.  
The calibration due date will also appear on the asset measurement report if the "Generating report" menu item "Alignment measurement components" is activated.



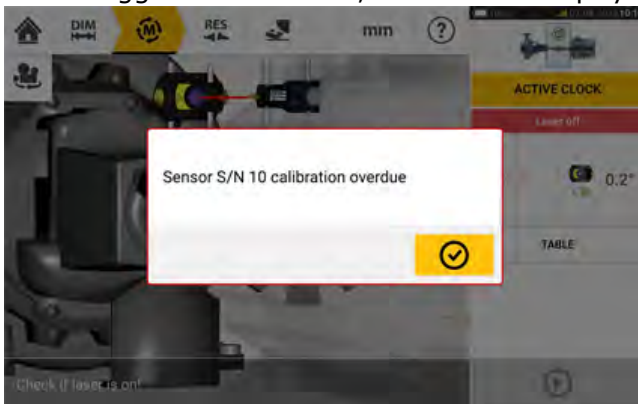

If the sensor calibration due date has expired and the sensor is connected through Bluetooth to the rugged touch device, a calibration expiry notification appears on the display.



Tap  to close the notification.

## Best practice

---

### Mounting sensor and reflector

- The 'Dimensions' screen shows the sides where the sensor and reflector are to be mounted. If necessary, use , the "Camera" icon to rotate the view on the screen to allow machines be viewed as they physically appear.
- Mount the brackets directly on the shafts or couplings.
- Mount sensor and reflector as low as possible on the supplied support posts. The couplings must not block the path of the laser beam.
- Mount sensor on the machine designated stationary and reflector on the machine designated moveable.
- Both sensor and reflector must not touch one another or the machine casings during shaft rotation.

### Entering dimensions

- Dimensions measured to within  $\pm 3$  mm ( $\pm 1/8$  in.) using a tape measure with 1 mm ( or 1/32 in.) divisions are acceptable.
- When entering the dimension between the front and back feet, use the distance between the center of the two foot bolts.
- When measuring any dimensions from the sensor, ensure that the tape measure reading starts at the arrow tip (**1**) of the marking on top of the sensor.

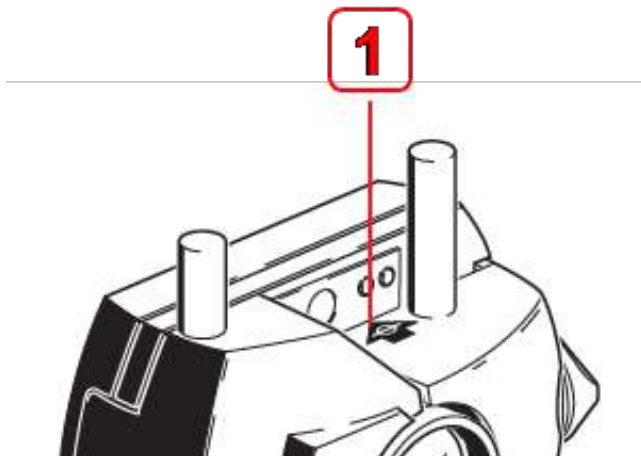

If using an industrial tape measure, insert the hook in the distance marking slot at the arrow tip (**1**).

### Initializing sensor

- Should "communication error" occur, tap detector area below the hint "Communication error" then tap "Sensor list" to check whether the sensor has been detected.
- Any new Bluetooth connection must initially be scanned before communication between sensor and the rugged device can be established. The scanning process is prompted by

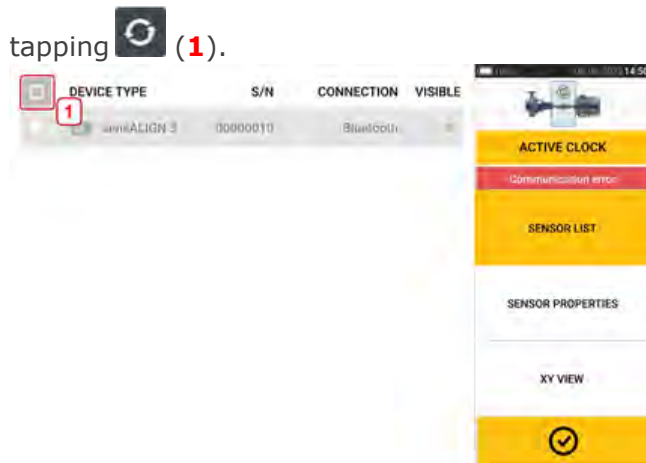

## Causes that may influence measurement

- Incorrect or loose mounting of bracket frame, support posts
- Incorrect or loose mounting of sensor and reflector on the support posts
- Loose machine anchor bolts
- Unstable or damaged machine foundation
- Mounted components strike machine foundation or machine casings or frame during shaft rotation
- High breakaway torque from rotatable and non-rotatable shafts
- Coupling backlash
- Change of rotational direction during and between measurements
- Mounted components moved during shaft rotation
- Uneven shaft rotation
- Change in temperature within machines
- External vibration from other rotating machines

## Results and Live Move

- V is the vertical orientation of the machines viewed from the side.
- H is the horizontal orientation of the machines viewed from the top.
- The foot results which are used in correcting misalignment are position values with respect to the reference machine.
- The bold colored foot tolerance arrows show the direction and magnitude in which to move the machine. The color code also shows the attained alignment tolerance.

## Appendix

### Update Fluke 831 to a newer firmware version

Check the website to obtain the latest version. If in doubt, please con-tact your local representative.

- Download the update file to the desired directory on a PC.

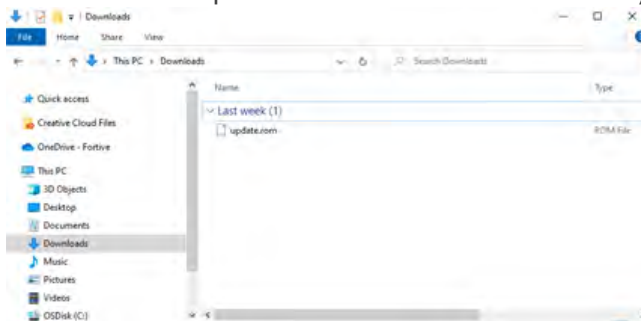

- Switch the rugged device on then connect it to the PC. A hint to allow the Windows PC access the rugged device comes into view.
- On confirmation, the rugged device shows up in the File Explorer.

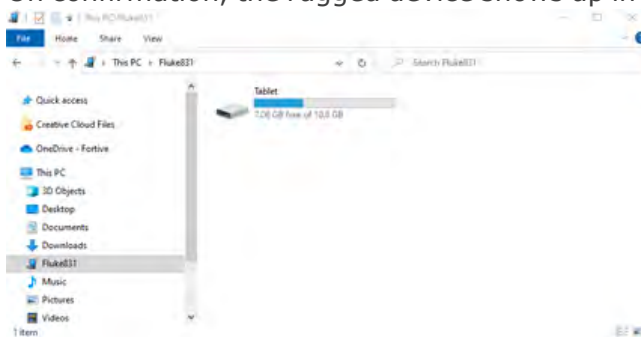

- Double-click "Tablet" to access folders in the rugged device.

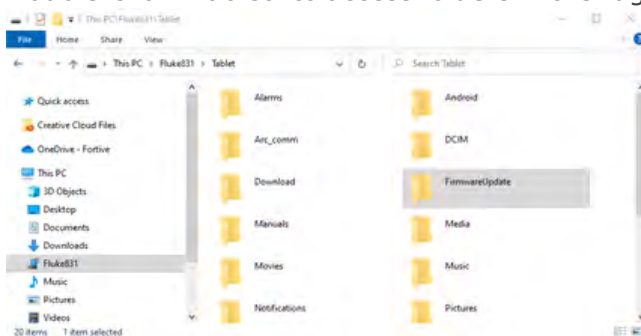

- Transfer the "update.rom" file to the rugged device folder "FirmwareUpdate".

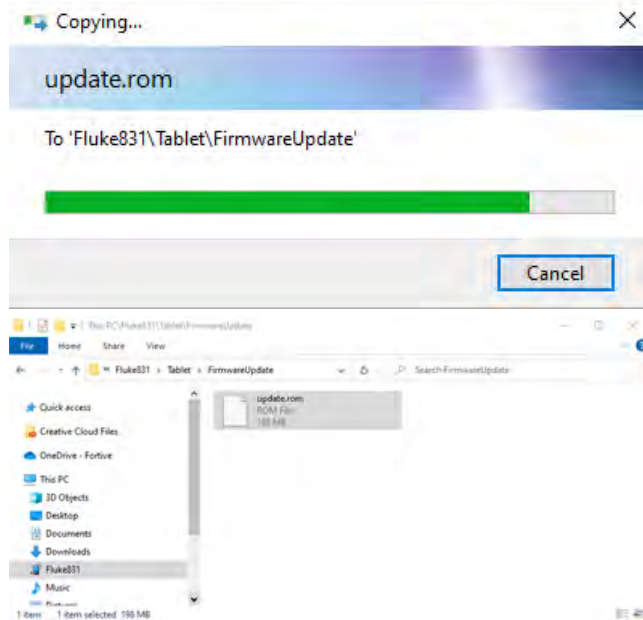



- After the update file has been copied to the "FirmwareUpdate" folder, disconnect the rugged device from the PC. This hint is shown.

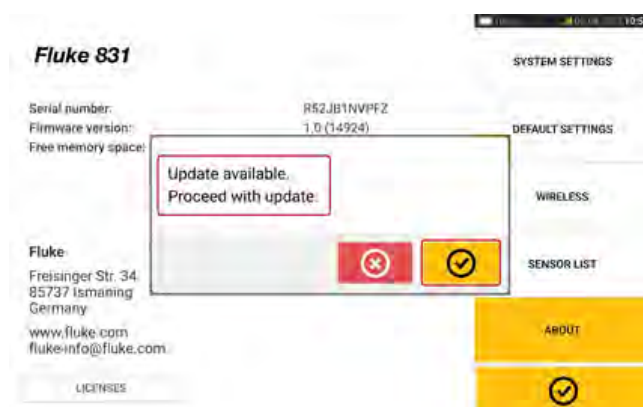

### Note

DO NOT tap the device or press any of the hard keys. Wait for the next hint to appear.



- Tap  to proceed with the firmware update



**Note**

Follow all the update instructions carefully, and confirm all requested installations.

- Once the update is completed, a hint to restart the tablet device is shown.

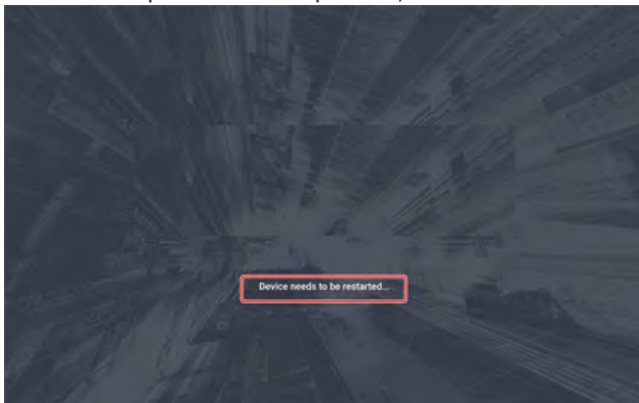

- Press and hold down the power key briefly. "Power off" and "Restart" icons appear on the display.
- Tap "Restart". The update is now completed and may be checked and confirmed in the "about" menu item in configuration after the restart.



## Documentation

The content in this document is available also on the rugged device as context sensitive help.

Tap the question mark icon  wherever it is available to open context sensitive help.

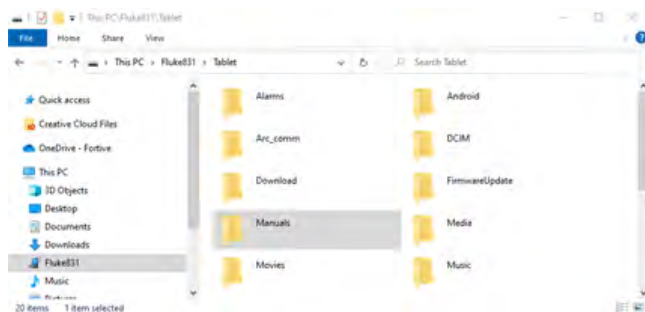



## Technical data – Rugged touch device

<b>Fluke 831 rugged device</b>	
CPU	Processor: Exynos 9810, 2.7GHz, 1.7GHz Octa-Core Memory: 4 GB RAM, 64 GB Flash memory
Display	Technology: TFT Resolution: 1920 x 1200 Pixel Size: 203.1 mm (8")
Connectivity	Wi-Fi: 802.11 a/b/g/n/ac/ax 2.4G+5GHz, HE80, MIMO, 1024-QAM Bluetooth Version: 5.0 RFID
Camera	Main Camera - Resolution: 13.0 MP Auto Focus Front Camera - Resolution: 5.0 MP
Environmental protection	IP68 (dustproof, submersible 1.5 m)
Temperature range	Operation: -20°C to 50°C (-4°F to 122°F)
Battery	Type: Li-ion rechargeable battery 3.85 V / 5050 mAh / 19.44 Whh Operating time: Up to 11 hours
Dimensions	Approx. 256 x 149 x 35 mm (10 5/64" x 5 55/64" x 1 3/8")
Weight (without hand straps)	Approx. 710 g (1.6 lbs)

## Technical data – sensALIGN 3 sensor

<b>sensALIGN 3 sensor</b>	
Measurement principle	Coaxial, reflected laser beam
LED indicators	1 LED for laser beam status and battery status 1 LED for Bluetooth® communication
Power supply	Battery: Lithium-ion rechargeable battery 3.7 V / 5 Wh Operating time: 10 hours (continuous use) Charging time: Using charger – 2.5 h for up to 90%; 3.5 h for up to 100% Using USB port – 3 h for up to 90%; 4 h for up to 100%
Environmental protection	IP 65 (dustproof and water jets resistant), shockproof Relative humidity: 10% to 90% (non-condensing)
Ambient light protection	Yes
Temperature range	Operation: -10°C to 50°C (14°F to 122°F) Charging: 0°C to 40°C (32°F to 104°F) Storage: -20°C to 60°C (-4°F to 140°F)
Dimensions	Approx. 105 x 69 x 55 mm (4 9/64" x 2 23/32" x 2 11/64")
Weight	Approx. 210 g (7.4 oz) with dust cap
Detector	Measurement range: Unlimited, dynamically extendible (US. Patent 6,040,903) Resolution: 1 µm (0.04 mil) and angular 10 µRad Accuracy (avg): > 98%
Inclinometer	Measurement range: 0° to 360° Resolution: 0.1° Inclinometer error (Ta = 22°C): +0.3 % read out
Laser	Type: Semiconductor laser diode Wavelength: 630 – 680 nm (red, visible) Safety class: Class 2 according to IEC 60825-1:2014 The laser complies with 21 CFR 1040.10 and 1040.11 except for deviations pursuant to Laser Notice No. 50, dated June 24, 2007. Beam power: < 1 mW Beam divergence: 0.3 mrad Safety precautions: Do not look into laser beam
External interface	Integrated Bluetooth 4.1 Smart Ready wireless communication
Transmission distance	Up to 30 m (98 ft) direct line of sight

**CE conformity** Hereby, Fluke declares that the radio equipment contained in this product is in compliance with Directive 2014/53/EU. The full text of the EU declaration is available

**Country radio certifications**

## Technical data – Reflector (prism)

### Reflector (prism)

Type	90° roof prism
Accuracy (avg):	> 99%
Environmental protection	IP 67 (submersible, dustproof)
Temperature range	Operation: -20°C to 60°C (-4°F to 140°F) Storage: -20°C to 80°C (-4°F to 176°F)
Dimensions	Approx. 100 x 41 x 35 mm (4" x 1 5/8" x 1 3/8")
Weight	Approx. 65 g (2.3 oz)