



DYNEO™ DD

english

Immersion / Open Bath / Refrigerated Circulators Operating Instructions

Important: keep original operating manual for future use.

1.951.1300-V1

Table of contents

1	DYNEO DD product overview	5
2	Intended use	6
3	DYNEO DD - Description	7
4	Explanation of safety information	8
4.1	Explanation of other information	8
5	Safety instructions	9
6	Operator's responsibility - safety instructions	11
6.1	Requirements for the operating personnel	11
6.2	Operating and ambient conditions for using the unit	11
6.3	Operating the unit	12
7	Control and functional elements	14
7.1	Installation of the circulator	17
8	Preparations for operating the device	18
8.1	Securing the immersion circulator	18
8.2	Closed stainless steel bath tanks	23
8.3	Basic refrigeration baths	24
8.4	Bath fluids	25
8.5	Temperature control for external connected systems	27
8.6	Tubing	28
9	Commissioning	29
9.1	Excess temperature and low level safety devices	29
10	Filling	31
10.1	Pump settings	31
11	Display elements	33
12	Switching on/selecting language	36
13	Adjust safety	38
13.1	Temperature limits	38
13.2	Adjusting setpoint limits	39
14	Adjusting setpoint temperature/start/stop	41

15 Main menu	42
15.1 Applying settings.....	42
15.2 Thermodynamic.....	46
15.3 Use programmer	52
15.4 Connecting unit with PC	60
15.5 Install unit.....	69
15.6 Record data.....	73
15.7 Service.....	75
16 Emptying the bath tank	76
17 Technical data	77
17.1 Technical data for circulator.....	77
17.2 Technical data for refrigeration circulation circulator.....	78
17.3 Refrigerant	85
18 Materials of parts in contact with the bath fluid	86
18.1 Circulator	86
19 Accessories	87
19.1 For external connection.....	87
19.2 For open baths	87
20 Maintenance, cleaning, storage	88
20.1 Maintain the refrigeration capacity.....	88
20.2 Cleaning.....	88
20.3 Storage.....	89
21 Repair service	90
22 Warranty	92
23 Waste disposal	93
23.1 Packaging.....	93
23.2 Unit	93
23.3 Refrigerant	93
24 EC conformity	94

Congratulations.

You have made an excellent choice.

JULABO thanks you for the trust.

This operating manual is designed to familiarize you with the operation of our units and their possible applications. Please read the operating manual carefully.

Please call us if you have any questions about the operation of the unit or about the operating manual.

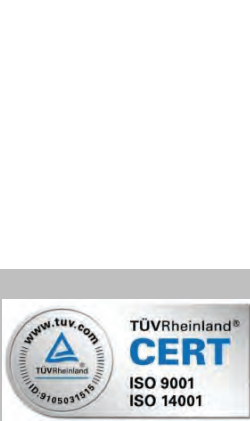

The JULABO quality management system

The standards for the development, production and distribution of temperature control devices for laboratory and industry use satisfy the requirements of ISO 9001 and ISO 14001. Registration certificate No. 01 100044846.

Unpacking and inspection

If the packaging is damaged or if you discover any concealed transport damage when you have unpacked the devices and the accessories, please notify the supplier in the form of a statement of damage.





NOTICE

The operating manual

- should be kept for future use.
- must be available to operating personnel at all times.

1 DYNEO DD product overview

The circulators of the DYNEO DD series can be combined with the stainless steel BC baths, and the refrigerated bath base unit.

Immersion circulator	Bath circulator	Refrigerated circulator
 <p>DYNEO DD for bath tanks up to 50 l.</p>	 <p>DYNEO DD BC6 for temperate control in an internal bath or an external application.</p>	 <p>DYNEO DD 601F for standard temperature control and routine tasks.</p>

2 Intended use

JULABO circulators are laboratory devices which are designed for the temperature control of certain liquid media in a bath tank or with a refrigeration unit. The bath fluids recommended by JULABO must be used as tempering media.

Units with pump connections allow the tempering tasks to be carried out in an external temperature control system.

JULABO circulators are not designed for the direct temperature control of foods, semi-luxury foods and tobacco, or pharmaceutical and medical products.

- Direct temperature control means unprotected contact between the object and the tempering medium (bath fluid).
- The devices are not suitable for use in potentially explosive environments.

3 DYNEO DD - Description

Special features

- Internal and external applications
- Easy to switch between internal and external circulation
- Temperature range -50 °C to +200 °C
- Large color TFT display
- Easy to operate using the state-of-the-art turn & push controller
- Multi-lingual user interface
- Integrated programmer
- Heating capacity 2 kW
- USB interface
- Analog interfaces (optional)
- Class III (FL) according to DIN 12876-1
- Continuously adjustable, powerful pump
- External Pt100 sensor connection
- RS232 interface (optional)



NOTICE

It is important to follow these safety instructions to prevent personal injury and property damage. These instructions apply in addition to the safety instructions at your workstation.

It is essential that you read the user information before starting the device.

4 Explanation of safety information



The operating manual contains warnings to increase safety when using the device. The general warning sign, consisting of an equilateral triangle surrounding an exclamation sign and reproduced in various signal colors, is preceded by the signal words.

"Warning of a danger zone".

The significance of the danger is classed with a signal word. Read the instructions carefully and follow them,



⚠ DANGER

This signal word designates a danger with a high level of risk which, if it not prevented, will result in death or serious injury.



⚠ WARNING

This signal word designates a danger with a medium level of risk which, if it not prevented, may result in death or serious injury.



⚠ CAUTION

This signal word designates a danger with a low level of risk which, if it not prevented, may result in minor or moderate injury.

NOTICE

designates a possibly harmful situation. If it is not prevented, the system or something near it may be damaged.

4.1 Explanation of other information



HINT

Your attention is drawn to something special by this.

Designates user hints and other useful information.



Dangers at second glance

Designates states which only occur after the start of an action and could have been prevented if the warning had been heeded.



Informative note

Provides additional information.

5 Safety instructions

It is important to follow these safety instructions to prevent personal injury and property damage. These instructions apply in addition to standard safety practices for working places.

- It is essential that you read the user information before starting the unit.
- Use PPE (safety gloves, safety shoes, safety goggles).
- Transport the unit carefully. The interior of the unit can also be damaged by impacts or if it is dropped.
- Do not loiter under the unit during transportation and operation.
- The unit is not intended for use in potentially explosive areas.
- Please observe the specifications for the minimum space requirement when setting up the unit.
- Only operate the unit in rooms that are well-ventilated, dry and free of frost.
- Switch the unit off immediately if there is refrigerant leakage.
- Place the unit on a flat surface of non-flammable material.
- Operate the unit under an exhaust hood as much as possible.
- Do not start the unit if it is damaged or leaking.
- Compare the mains voltage and frequency with the specifications on the type plate.
- Only connect the unit to a fused mains connection via a FI circuit breaker ($I_a=30$ mA).
- Only connect the unit to a power socket with ground contact (PE – protective earth)!
- The power supply plug serves as safe disconnecting device from the power supply network and must be freely accessible at all times.
- Check the mains cable regularly for signs of damage.
- Do not start the unit if it has a damaged power cable.
- Keep the mains cable away from hot pump connections.
- Refer to the safety sticker. Parts of the unit can be hot or cold.
- Never use the unit without bath fluid.
- Do not reach into the thermal bath fluid.
- Check the filling level of the bath fluid at regular intervals. The pump and heater must always be completely covered with bath fluid.
- Adjust over-temperature safety device below the flash point of the bath fluid.

- Consider the restricted working temperature range if you are using plastic bath tanks.
- Monitor the heat expansion of the bath oils as the bath temperature rises.
- Prevent water getting into hot bath oils.
- Use suitable tubing.
- Secure the tubing connections to prevent them sliding off.
- Do not bend the bath fluid tubing.
- Check the hoses at regular intervals for signs of material fatigue (for example cracking).
- Do not drain the bath fluid when it is hot.
- Check the temperature of the bath fluid before draining it, for example by switching on the unit briefly.
- Switch off the unit and pull the plug before moving the unit or carrying out service or repair work.
- Have all service and repair work carried out by authorized specialists only.
- Switch off the unit and disconnect it from the power supply before cleaning it.
- Drain the unit completely before transporting it.

6 Operator's responsibility - safety instructions

Products manufactured by JULABO GmbH ensure safe operation when installed, operated and according to common safety regulations. This section explains the potential dangers which may occur when operating the unit and specifies the most important safety measures to prevent these dangers as far as possible.

6.1 Requirements for the operating personnel

The operator is responsible for the qualifications of the personnel operating the unit. Ensure that the personnel who operate the unit are trained in the relevant work application by a trained person.

The operative must receive regular training about the dangers involved with their work and about action to prevent such dangers.

Ensure that everybody involved with the operation, maintenance and installation have read and understood the safety information and the operating manual. The unit may only be configured, installed, maintained and repaired by trained personnel.

If hazardous substances or substances which may become hazardous are used, the unit may only be used by a person who is completely familiar with these substances and the unit. This person must be able to assess the possible dangers in full.

6.2 Operating and ambient conditions for using the unit

- Avoid impacts on the housing, vibrations, damage to the operative keypad (keys and display) and heavy soiling.
- Ensure that the product is checked at regular intervals suitable for its frequency of use to ensure that it is in perfect condition.
- Check the proper condition of the mandatory warning, prohibition, and safety labels at least every 2 years.
- Ensure that the mains supply has a low impedance to prevent influencing of other units powered in the same mains.
- The unit is designed for operation in a controlled electromagnetic environment. This means that in an environment of this nature, transmission equipment such as mobile phones should not be used in the immediate vicinity.
- Other units with components which are susceptible to magnetic fields may be influenced by magnetic radiation. We recommend to maintain a minimum distance of 1 m.
- Permissible ambient temperature: max. 40 °C, min. 5 °C.
- The relative humidity should not exceed 50% (40°C).
- Do not store in an aggressive atmosphere. Protect from dirt.

- Protect from direct sunlight.

6.3 Operating the unit

The bath may be filled with flammable materials. **Fire hazard!**

Chemical dangers may occur, depending on the bath medium.

Refer to all warnings on the substances used (bath fluids) and in the relevant instructions (safety data sheets).

The formation of explosive mixtures is possible if the ventilation is inadequate.

Only use the units in well ventilated areas. The unit is not suitable for use in potentially explosive environments.

Special substance specifications (bath fluids) must be observed for correct operation. Caustic or corrosive bath fluids must not be used.

When using hazardous substances or substances which may be hazardous, the operator must apply the enclosed safety symbols (1 + 2a or 2b) on the control side panel where they are clearly visible:



Warning of a danger zone. Attention!
Observe documentation. (Operating manual, safety data sheet)



It is essential that you read the user information prior to operation.
Area of validity: EU



It is essential that you read the user information prior to operation.
Area of validity: USA, NAFTA

As a result of the wide range of operating temperatures, special care and caution is essential.

There are thermal dangers: Burns, scalds, hot steam, hot parts and surfaces which may be touched.



Warning about hot surfaces.

(The label is applied by JULABO)

If external units are connected

Refer to the instructions in the manuals for the external units which you connect to the JULABO unit, particularly the safety instructions.

The connection assignment of the plugs and the technical data for the products must be observed at all times.

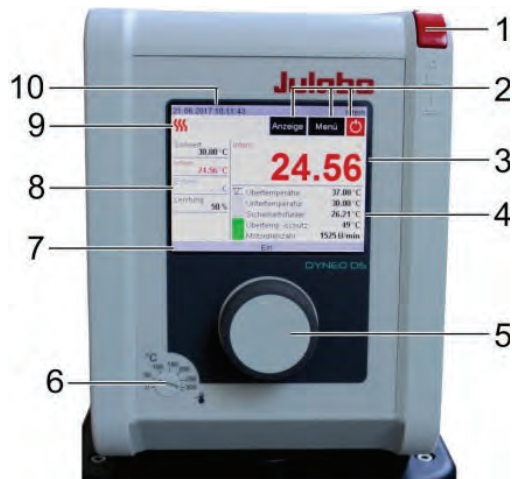

7 Control and functional elements

Front

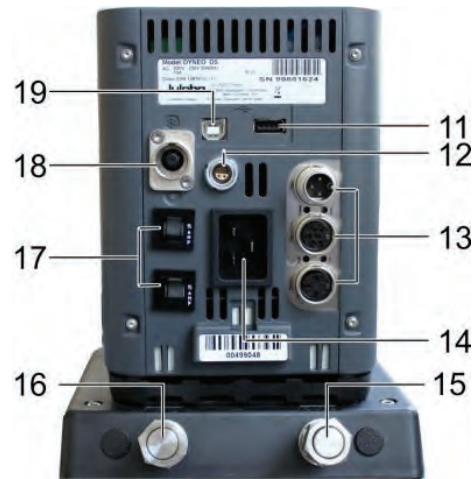

Rear



Pos.	Designation
1	Main switch
2	Operating elements: Display, menu, start/stop
3	Actual value display – internal/external
4	Display of safety values High temperature Low temperature Safety sensor High temperature cut-off Motor speed Liquid level indicator
5	Central controller
6	Adjustable excess temperature safety device
7	Unit status indicator (On/Standby)
8	Temperature displays Setpoint Internal temperature External temperature Performance display
9	Control indicator  heating /  cooling
10	Date/time display, internal/external control, analog/digital actuating value specification

11	USB host interface (type A)		
12	Connection: external PT100		
13	Optional: Analog connections Alarm Reg-/Eprog Standby RS232 interface		
14	Electrical connection: Integrated connector to supply power to the circulator (Power cord included in the scope of supply).		
15	Pump connection: Supply,	OUT	M16x1, external
16	Pump connection: Return,	IN	M16x1, external
17	Fuses: Miniature circuit-breakers, for refrigeration machine Resettable fuses for 600F refrigeration units (115 V, 100 V)		
18	CAN plug for connecting to the circulator.		
19	USB-Device-interface (Type B) for data transfer to PC, e.g. for control applications with the EasyTEMP software.		

Refrigerated Circulators DYNEO DD 300F

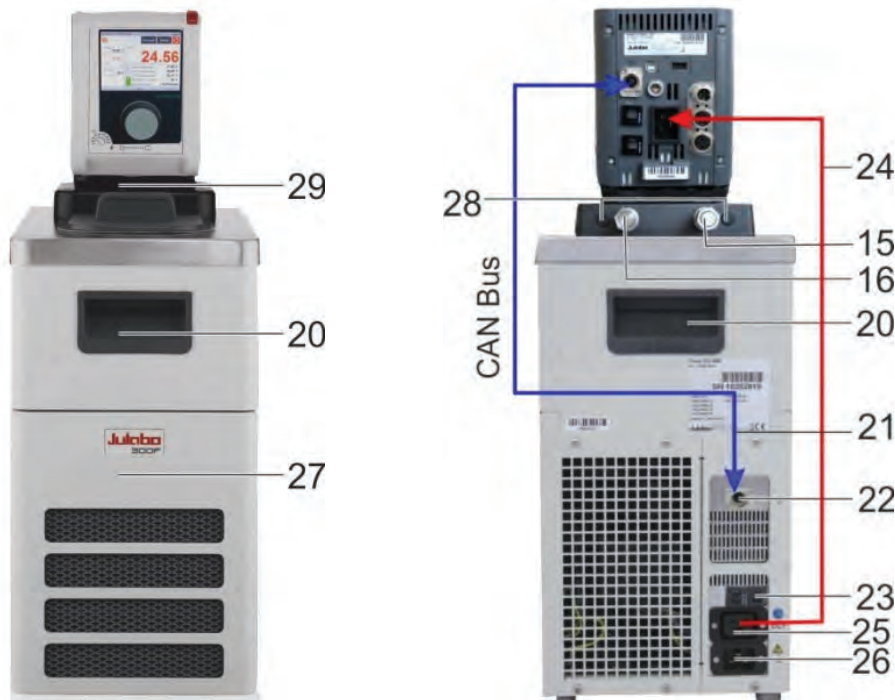

20	Recessed handle (front, rear)
21	CAN connection cable for refrigeration machine circulator
22	CAN plug for connecting to the circulator.

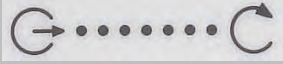
23	Fuses: Miniature circuit-breakers, for refrigeration machine
24	Connection cable: Voltage supply, refrigeration machine → circulator
25	Electrical connection: Integrated connector to supply power to the refrigeration circulator
26	Electrical connection: Integrated connector to supply power to the refrigeration machine
27	Drain tap and drain port (behind ventilation grille)
28	Caps (connectors for the cooling coil)
29	Pump switchover with DYNEO DD, Delivery  external.....internal

Accessories, included in the supply



1x Main cable for voltage supply for the refrigeration machine (26) and circulator (14) (use one only for refrigeration circulator)



1x Connection cable: Refrigeration machine (25) → Circulator (14)

1x CAN connection cable (21)

Mains cable, country-specific, order number.

7.1 Installation of the circulator



CAUTION

Danger of scalding due to leaks from the baths

The JULABO plastic baths are not solvent-resistant. JULABO plastic bath tanks are for water at a working temperature range from +20°C to +100°C.

Do not contaminate the bath fluid with solvents.

Things to keep in mind during the installation process:

WARNING

Risk of tipping due to improper transportation

Crushing, damage to the unit

- Use PPE (safety gloves, safety shoes, safety goggles).
- Carry the unit with 2 persons (see the Technical Data for the weight).
- Transport the unit carefully on firm, level ground. The interior of the unit can also be damaged by impacts or if it is dropped.
- Do not loiter under the unit during transportation and operation.
- The installation site should be a sufficiently large room to ensure that it does not become too hot due to the heat emission.
- The surface for the device should be flat and made of non-flammable material.
- A specific room size is prescribed for refrigerated circulators.
- At high temperatures, position the unit under an exhaust hood as much as possible due to potential vapors from the thermal bath fluid.
- Observe the safety sticker - do not remove!

8 Preparations for operating the device

8.1 Securing the immersion circulator



! WARNING

Danger of electric shock.

Carefully secure the immersion circulator on the bath vessel. Poorly installed circulators can fall into the bath tank.

Have the unit checked by a service technician prior to re-use.

The heater must not be in contact with the wall or the bottom of the bath tank. Minimum distance 15 mm.

Pull the plug to disconnect the unit from the power supply. Only then take the immersion circulator out of the bath tank.

A range of accessories is available for various applications:

- Bath clamp (for securing the circulator to baths)
- Bracket (for securing the circulator to JULABO refrigeration machines)
- Pump set (for connecting external applications)
- Cooling coil (for operating close to ambient temperature)
- Stand holder with rod (for securing to a laboratory stand)



Bath attachment clamp, order No. 9970420

- Pay special attention to the circulator's immersion depth (see Technical data) when selecting the bath.
- Place the bath on a flat surface on a pad made of non-flammable material.
- Secure the bath attachment clamp to the bath tank. The wall thickness may be up to 30 mm.
- Attach the circulator with a "click" to the bath attachment clamp.



Stand attachment, order No. 9970022

For use with glass tanks a stand attachment with rod is available as an optional accessory.

The circulator must be mounted vertically and secured against rotation. If necessary, secure the nuts of the rod also.



Bracket, order no. 9970170

Installation on the circulator



Disassemble heater from circulator (Torx: 2.5 mm).



Slide bracket over pump.



Secure the bracket to the base of the circulator using the four screws.

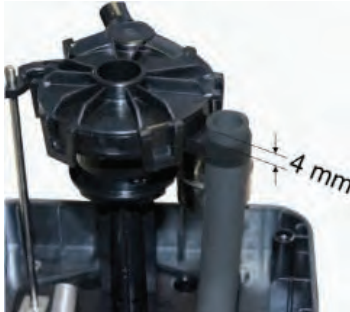

Push the end of the hose on the "IN" side into the holding device on the pump, until an excess end of approx. 4 mm is created.



Remove the cap from the pump fitting.



Attach hose until it stops on the pump fitting. Label "PUMP >>..." in the direction of the pump fitting.



Fasten hose with 1-ear clamps (2x).



Insert heater and screw tight.



Connecting an external system:

- Remove the union nuts and sealing plates from the pump connectors.
- The hose connectors can be used for hoses with M16x1 connections in this state.

Or:

- Secure hose olives to the union nuts.
- Connect tubings and secure them with hose clips to prevent them sliding off.
- Connect the hoses for the supply and return to the pump connectors and the external consumer and secure them with hose clips.
- Switch the pump function to external circulation.



Pump set, order No. 9970141

Installation on the circulator

- Push the end of the tubing on the "OUT" side on to the port on the pump.
- Secure against slipping using the tube clamps.
- Push the end of the tubing on the "IN" side on to the holding device on the pump.
- Secure the pump housing to the base of the circulator using the two screws.
- Attach the circulator to the bath clamp.
The total immersion depth will be reduced due to the pump set.



Connect an external system (also applies to bracket)

- Remove the union nuts and sealing plates from the pump connectors.
- The hose connectors can be used for tubing with M16x1 connections in this state.

Or:

- Secure barbed fittings to the union nuts.
- Connect tubing and secure them with tube clamps to prevent them sliding off.
- Connect the tubing for the supply and return to the pump connectors and the external consumer and secure them with tube clamps.
- Switch the pump function to external circulation.



Cooling coil, order No. 9970100

A cooling coil is required for working at around ambient temperature (20 °C) A cooling water flow rate of 45 ml/min is generally sufficient to compensate for the intrinsic temperature.

The cooling water temperature should be at least 5 °C lower than the working temperature.



Install the cooling coil on the pump set

- Remove the caps from the pump set.
- Insert the ends of the cooling coil through the fastening boreholes and secure them with the washers and hex nuts.
- Install the connection ports to the cooling coil.
- Slide the cooling water hoses over the connection ports and prevent slipping.



Bracket with cooling coil, order No. 9970171

Install the cooling coil on the bracket

- Remove the caps from the bracket.
- Slide the ends of the cooling coil through the fastening boreholes.
- Secure them with the washers and hex nuts.
- Install the connection ports to the cooling coil.
- Slide the cooling water tubing over the connection ports and prevent slipping.

8.2 Closed stainless steel bath tanks



Intended use

JULABO BC4, BC6, BC12 and BC26 closed stainless steel baths can be combined with JULABO circulators. When combined with these circulators they are designed for controlling the temperature of JULABO recommend liquid media.

Technical details for the sealed baths

The circulators feature the bracket which is secured to the baths.

Type		BC4	BC6	BC12	BC26
Order No.		9905504	9905506	9905512	9905526
Temperature range	°C	+20...+300			
Approx. weight	kg	5.2	6.4	8.2	15.0
Dimensions (WxDxH*)	cm	23x41x42	24x44x47	33x49x47	39x62x48
Useful bath opening (WxLxD), inner	cm	13x15x15	13x15x20	22x15x20	26x35x20
Filling volume Min. ... Max.	l	3.0...4.5	4.5...6.0	8.5 ... 12.0	19.0 ...26.0
Materials for parts in contact with the medium		Bath and drain cock: 1.4301 / 304H Bath/Bath cover seal: FKM Viton® O-ring on drain cock: FKM Viton®			

* / With circulator

8.3 Basic refrigeration baths



Intended use

The basic refrigeration baths can be combined with JULABO circulators. In combination with these circulators, they are intended for the temperature control of liquid media (bath fluids).

Technical details for basic refrigeration baths

The bracket is required for installation on the circulator.

Type		200F	201F	300F	600F
Order No.		9461701	9461702	9461703	9461704
Temperature range	°C	-20...200	-20...200	-25...200	-35...200
Weight	kg	26,0	25,0	28,0	36,0
Dimensions (WxDxH*)	cm	23x39x65	44x41x44	24x42x66	33x47x69
Useful bath opening (WxLxD), inner	cm	13x15x15	13x15x15	13x15x15	22x15x15
Filling volume Min. ... Max.	l	3,0...4,0	3,0...4,0	3,0 ... 4,0	5,0 ...7,5
Materials for parts in contact with the medium		Bath and drain valve: 1.4301 / 304H Bath/Bath cover seal: FKM Viton® O-ring on drain valve: FKM Viton®			

Type		601F	900F	1000F	1001F
Order No.		9461705	9461706	9461707	9461707
Temperature range	°C	-40...200	-40...200	-40...200	-38...100
Weight	kg	36,0	52,0	49,0	68,0
Dimensions (WxDxH*)	cm	36x46x74	39x62x75	42x49x70	45x64x77
Useful bath opening (WxLxD), inner	cm	22x15x20	26x35x20	18x13x15	35x41x30
Filling volume Min. ... Max.	l	8,0...10,0	21,0...30,0	5...7,5	42...56
Materials for parts in contact with the medium		Bath and drain valve: 1.4301 / 304H Bath/Bath cover seal: FKM Viton® O-ring on drain valve: FKM Viton®			

* / with circulator

8.4 Bath fluids



! WARNING

Danger of burns and property damage if unsuitable bath fluid is used.

- Only use thermal oils which are recommended by JULABO. The viscosity of the oil is tailored to the pump capacity.
- Refer to the safety data sheet of the bath fluid, particularly its flash point.
- Set the excess temperature protector correctly.
- Always store bath fluid so that it cannot harm the environment.

There is a selection of recommended bath fluids on the JULABO homepage. Do not exceed the maximum viscosity of 50 mm²/s when you select your product.

Water as the bath fluid

NOTICE

If you use water as the bath fluid

Recommended water mixture:

70 % soft/decalcified water and 30 % tap water for a temperature range from 5 °C to 80 °C.

The parts of the bath which come into contact with the bath fluid may be damaged and cause the failure of the device.

The water quality depends on the local conditions.

- Hard water is not suitable for temperature control tasks due to its high lime content and will produce lime deposits in the bath.
- Ferrous water can cause corrosion, even on stainless steel.
- Chloric water can cause pitting corrosion.
- Distilled and deionized water is not suitable. Their specific properties cause corrosion in the bath, even on stainless steel.

i Check the quality of the water you use at regular intervals.

i Evaporation and constant refilling may produce a concentration of harmful substances in the bath.

You should therefore check the quality of the water in the bath at regular intervals.

i Replace the water in the bath in full at regular intervals.

Water bath protection products

The water bath protection product "Aqua-Stabil" is recommended to combat algae, bacteria and fungus formation.

Order No.	Designation
8 940 006	6x 100 ml bottles
8 940 012	12x 100 ml bottles



⚠ CAUTION

Unsuitable bath fluids.

JULABO cannot accept any liability for damage caused by the selection of an unsuitable **bath fluid**.

Unsuitable products include **bath fluids** which

- are highly viscous (much higher than recommended at the relevant working temperature).
- tend to crack.
- have a toxic, caustic or corrosive effect.



⚠ CAUTION

Properties of indirectly temperature-controlled fluids and substances

The intended use of the units includes the indirect temperature control of fluids.

We do not know which substances these are.

Many substances are:

- inflammable, flammable or explosive
- harmful
- polluting

In other words: dangerous

The user bears sole responsibility for handling these substances!

Use personal protective equipment!



The following questions should help to identify possible dangers and minimize risk.

- Are hazardous vapors or gases produced when heated?
Does operation of the bath has to be conducted in a fume hood?
- What should you do if a dangerous substance has been spilled on or in the device?
Obtain information on the substance before starting work and define a decontamination method.
- Are all hoses and electrical cables securely connected and routed?
Keywords: Sharp edges, hot surfaces during operation, moving machine parts, etc.

8.5 Temperature control for external connected systems



⚠ CAUTION

Danger from the incorrect use of external connected systems.

Unsuitable materials may cause the failure of the system.

Check the externally connected systems for the following:

- Compression strength.
- Corrosion resistance.
- Check the materials used for parts in contact with the medium.

The circulator is designed for the temperature control of external connected systems (temperature control system).

Connect an external system

Remove the union nuts and sealing plates from the pump connectors.

The tube connectors can be used for tubing with M16x1 (internal) connections in this state.

Tighten the connections with a maximum torque of 3 Nm, holding the nuts (a.f. 17 mm) as you do so.



Second method

Secure barbed fittings to the union nuts. Tighten the connections with a maximum torque of 3 Nm, holding the nuts (a.f. 17 mm) as you do so.

Connect tubing and secure them with tube clamps to prevent them sliding off.

Connect the tubing for the supply and return to the pump connectors and the external consumer and secure them with tube clamps.

Switch the pump function to external circulation.



8.6 Tubing



CAUTION

Danger of injury from defective tubing.

The bath fluid tubing is a potential source of danger at high working temperatures. Large volumes of hot bath fluids can be pumped out of a damaged tubing in a short period of time.

Possible consequences:

- Skin burns
- Breathing problems due to the hot atmosphere

Danger from unsealed pump connections.

- If the pump connections are not sealed, bath fluid may be pumped out without any control.
- Set the lever on the pump to internal circulation.
- Unused pump connections must always be sealed with sealing screws.

Danger from the incorrect use of tubing.

- The tubing must be suitable for the pressure and temperature range which results from operation and for the bath fluid (for example silicon oil must not be used with silicon tubings).
- Secure the tubing connections to prevent them sliding off. Use tube clamps.
- Do not kink the tubing. This will reduce throughput and may cause the maximum pressure in the system to be exceeded (glass reactor). The tube length should therefore be kept at a reasonable level.
- Prepare a maintenance plan.
Check tubing at regular intervals, at least once per year, for signs of material fatigue (for example cracking)
The tubing must be replaced at regular intervals if they are in constant use.

We recommend that you select suitable tubing on the JULABO homepage.

9 Commissioning



⚠ WARNING

Danger from mains voltage.

Risk of injury from electric power.

- Compare the mains voltage and frequency with the details on the model plate.
- Connect the device only to a safe power supply via FI-circuit breaker (IA = 30 mA).
- The device may only be connected to power outlets with a ground contact (PE – protective earth).
- The mains plug serves as a safe disconnecting device from the power supply network and must be freely accessible at all times.
- Do not start the device if it has a damaged mains cable.
- Check the mains cable regularly for signs of damage.
- We disclaim all liability for damage caused by incorrect line voltages!

Commissioning the circulator with a refrigeration machine

Connect the circulator and refrigeration machine using the mains lead. Connect them to the voltage supply using the fitted plug on the refrigeration machine and the mains lead. Connect the CAN jacks on both devices with the CAN connection cable to transfer data.



⚠ CAUTION

Cold or hot device surfaces

Frostbit or burns

What should be observed when operating the JULABO temperature control unit?

- Unit parts may develop high surface temperatures. A hot surface means it has a temperature of 60 °C / 140 °F or more.
- Let the device cool down to an uncritical safe temperature.
- Use safety gloves.

9.1 Excess temperature and low level safety devices

The safety devices are not affected by the control circuit. When they trip all actors are permanently shut down.

The alarm is displayed optically and acoustics with a continuous signal tone and the reason for the alarm is shown on the display as a number.

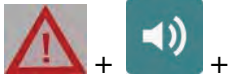

E 14



⚠ WARNING

Danger from damaged safety devices

Possible serious consequences for personnel and working areas.

Check the safety devices at least twice per year.

Excess temperature protector, IEC 61010-2-010

Turn the adjustable excess temperature protector to the cut-out point (actual temperature) using a screwdriver. The actors will be shut down on all poles, the circulator will show error message E 14, the "Alarm" control display will be lit and a continuous signal tone will sound.

Low level safety device, IEC 61010-2-010

The float switch in this device must be moved manually in the bath to test the function, for example using a screwdriver.

Push down the float until it reaches the mechanical stop.

The actors will be shut down on all poles, the circulator will show error message E 01, the "Alarm" control display will be lit and a continuous signal tone will sound.

10 Filling



⚠ CAUTION

Basic dangers.

The volume of oil used as bath fluid changes with the temperature. Starting from the volume when the bath is filled (room temperature) it may increase or decrease during operation.

The bath temperature rises - hot bath fluid can overflow.
The bath temperature falls - the low level alarm will stop the tempering process.

Monitor the level until it reaches working temperature.

Filling process

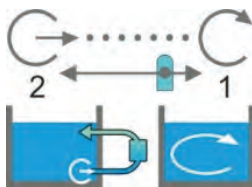

- Ensure that the drain valve is closed. Turn the knurled screw.
- Carefully insert bath fluid - never allow bath fluid to get inside the circulator.
- Do not exceed the maximum bath capacity (see Technical Data).
- 1 - The bath temperature rises - hot bath fluid can overflow.
- 2 - The bath temperature falls - the low level alarm will stop the tempering process.
- Monitor the level until it reaches working temperature.

10.1 Pump settings



To meet all the requirements for internal and/or external temperature control tasks, the direction of the pump flow is continuously adjustable.

For this purpose the lever below the head of the circulator can be adjusted from:

- 1.)  Max. internal pump flow to...
- 2.)  Max. external pump flow.

⚠ CAUTION

Risk of burns due to hot bath fluid

When adjusting the pump flow, make sure that no bath fluid is spilled from the bath opening due to circulation. For internal temperature control (external pump connections closed), the adjusting lever is to be set first to reduced internal circulation (2) before the circulator is started. After starting the circulator, circulation can be optimized through adjustment.

11 Display elements

Central controller (operating and function elements, pos. 5)

Using the central controller (rotary switch), the parameters can be selected and adjusted clockwise or counterclockwise. After selecting and adjusting, the setting is applied (confirmed) by pressing the controller.



Selecting (turning) Confirming (pressing)

Date/time

Internal/external setpoint specification

Heating/cooling icon



= Analog plug-in /



RS232 interface

R = remote control

USB interface

LAN connection

Display selection

Menu selection

Start/stop switch

Setpoint

Internal

External

Pump capacity in %

Liquid level indicator

Safety setting values

- High temperature
- Low temperature
- Safety sensor
- High temperature cut-off
- Motor speed

Standby unit mode

Different representations can be selected for the display:

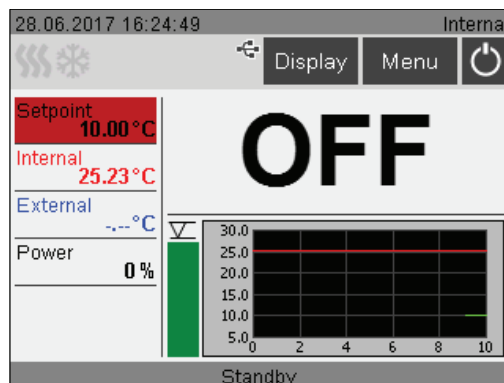
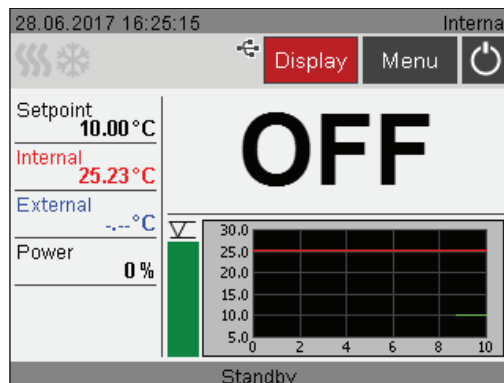
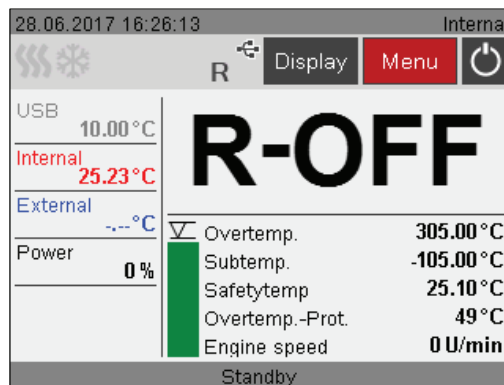

The current menu level is shown at the top left in the menu setting dialog (e.g., main menu).

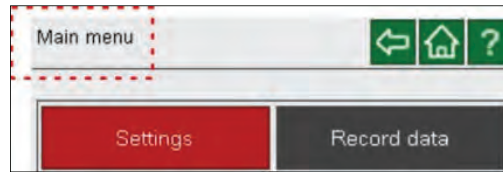

One level back.



Home (return to normal display).



Save value/parameter.



Call help menu

Select  button and  button and  confirm.

The operating manual is called up in the Internet using the QR code.



Displays in the error case

Error messages are divided into two categories:

ALARM Red > 

WARNING Yellow > 

An alarm leads to unit cut-off of heater, refrigeration aggregate, and circulating pump.

The unit switches into "OFF" state.

A warning does not lead to unit cut-off of heater, refrigeration aggregate, and circulating pump.

To call up help with troubleshooting the

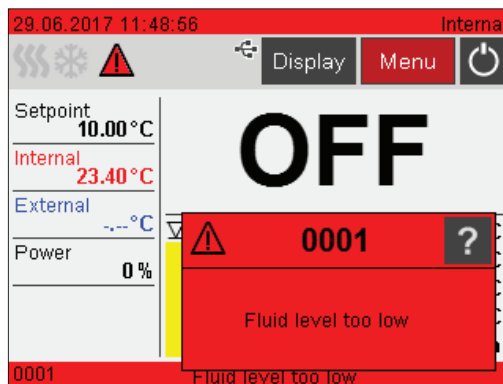

A low liquid level warning is outputted in the example below.



alarm and warning, select

and confirm

This display shows the required remedies.

The unit offers the option to define some of the warning limits.

If such a limit is exceeded, a warning is displayed (continuous display and signal), as long as the cause is present.

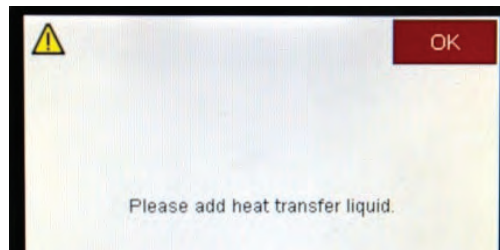
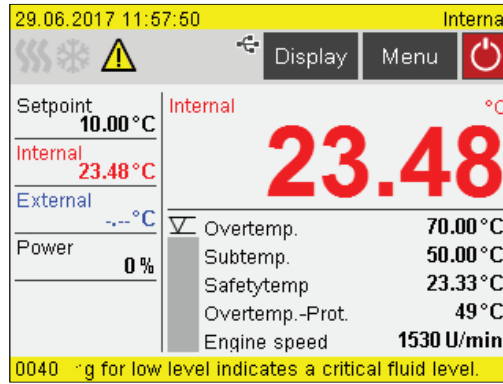

To correct the cause of the warning, bath fluid must be refilled.

12 Switching on/selecting language



It is a good idea to hold the circulator head with one hand whilst pressing the buttons.

Switching on:

The unit is switched on by pressing the main switch. Name and voltage variant of the unit are displayed briefly.

The unit switches into the operating mode, in which it was prior to being switched off:

Manual mode (operation at the unit), or Remote control mode (operation via PC).

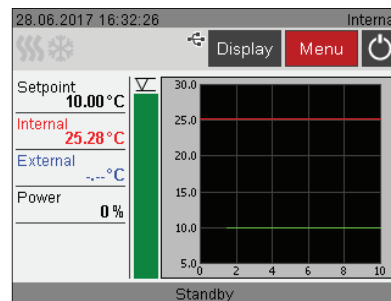
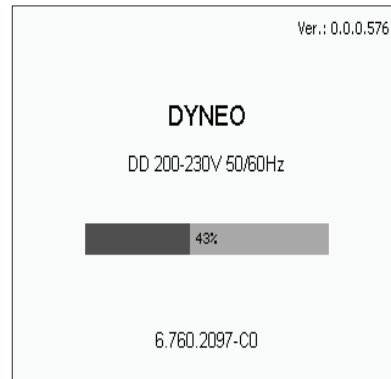

To adjust the language for the operating dialog,

proceed as follows. Select and



Menu

confirm



to call up the main menu.

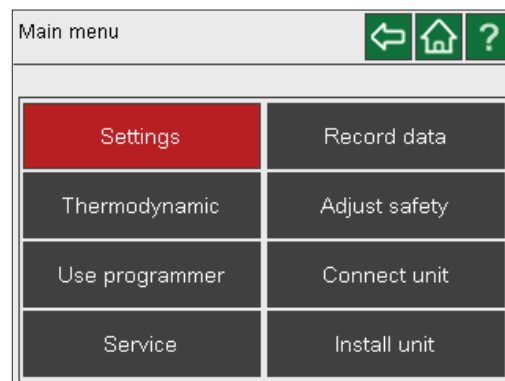

Select



and confirm

Select  in the

menu and confirm

Select  the screen

language and confirm

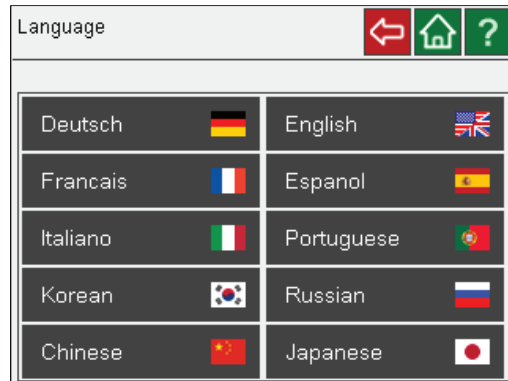
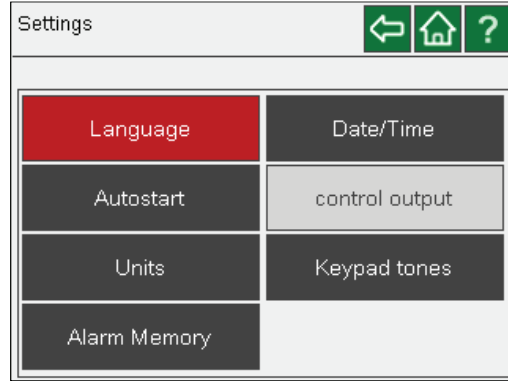

13 Adjust safety



! WARNING

Flammable bath fluid

Danger of burns

The unit can be filled with approved flammable media. Danger of fire! Chemical dangers may occur, depending on the bath medium. Refer to all warnings on the substances used (bath fluids) and in the relevant instructions (safety data sheets).

To avoid personal injuries and damage to the unit, several safety settings must be adjusted, and limit values set.

13.1 Temperature limits

Select  **Menu** to call up the main menu and confirm .

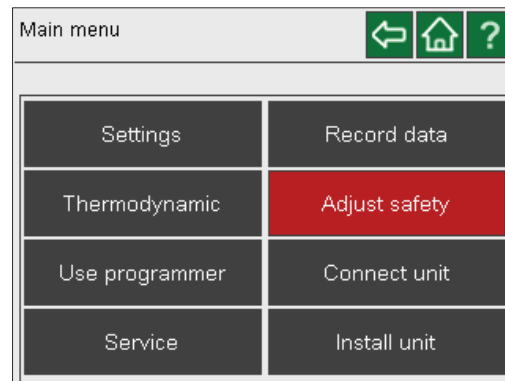

Select  **Adjust safety** and confirm .

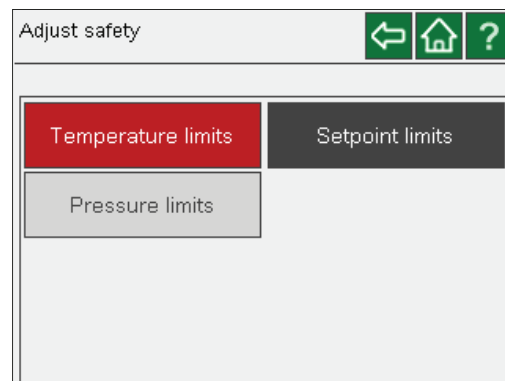

The pressure limits cannot be adjusted in this unit.



The low and high temperature are adjusted here. High temperature as well as the safety function can be adjusted using a screwdriver.

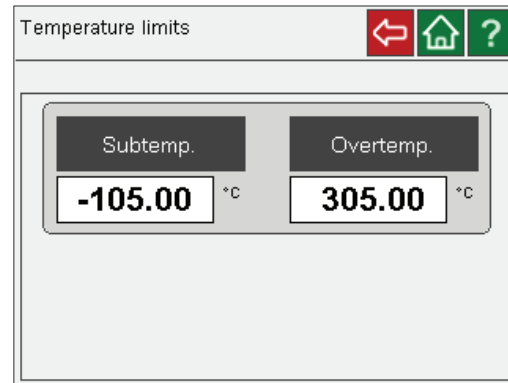

Adjusting low/high temperature

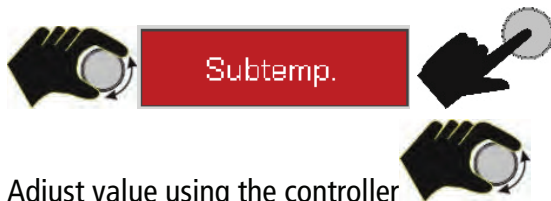

Adjust value using the controller

and confirm

Overtemp. is adjusted similarly.

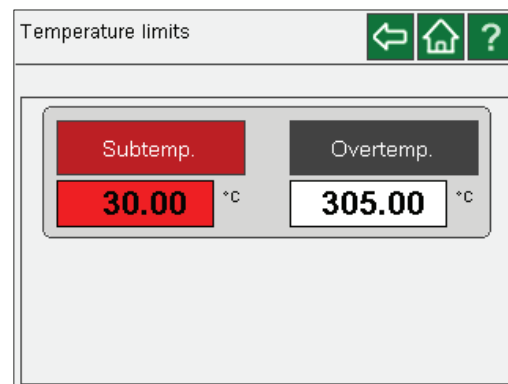

13.2 Adjusting setpoint limits

Minimum and maximum setpoints can be adjusted. This way, a range can be defined, in which process sequence execution is safe.

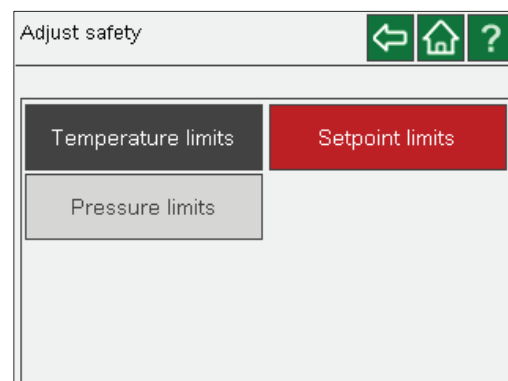

Setpoint min./max.



Adjust value using the controller



and confirm



Setpoint max. is adjusted similarly.

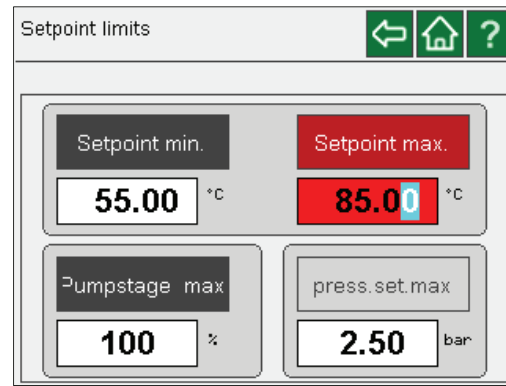
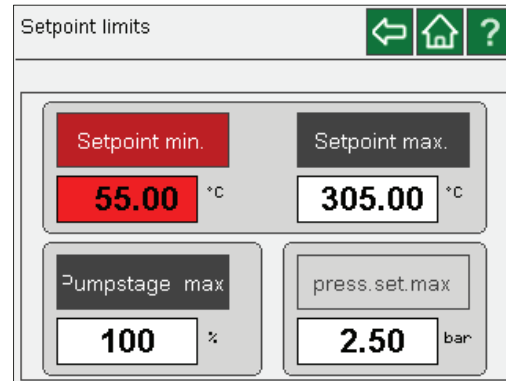

Adjusting pump stage max.

Select  **Pumpstage max** and confirm

Adjust value using the controller 

and confirm

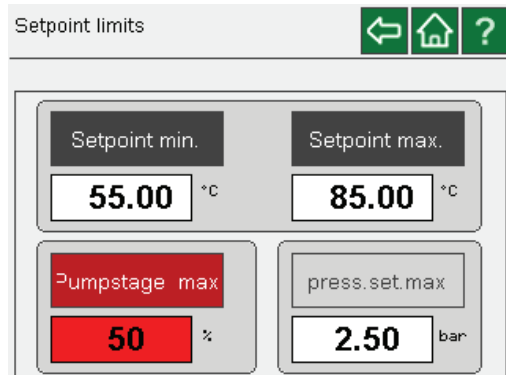

Max pressure setpoint (not implemented in this unit).

14 Adjusting setpoint temperature/start/stop

Here, you set the temperature, which should be reached and maintained in your application.

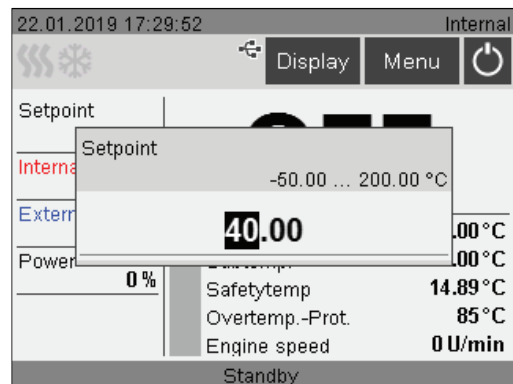
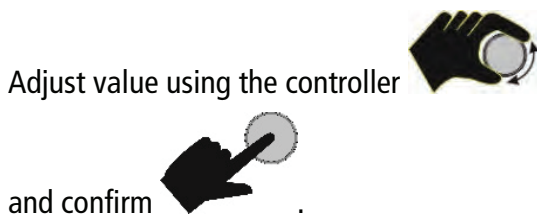
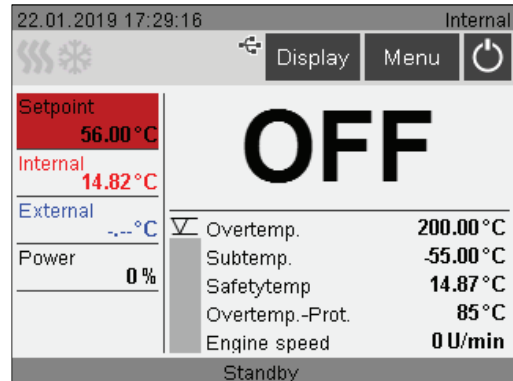

To start and stop the temperature control application

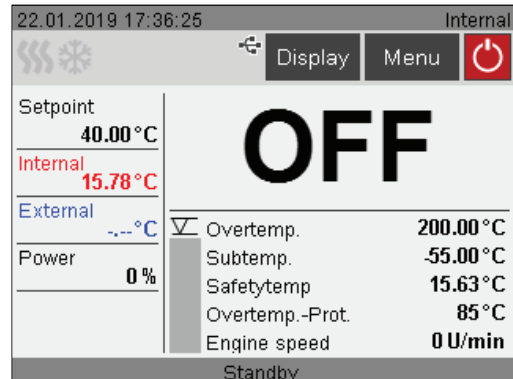
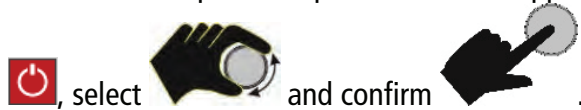

15 Main menu

In the main menu, you can find all unit settings and their parameter to adjust your unit to the temperature application.



To call up the main menu.

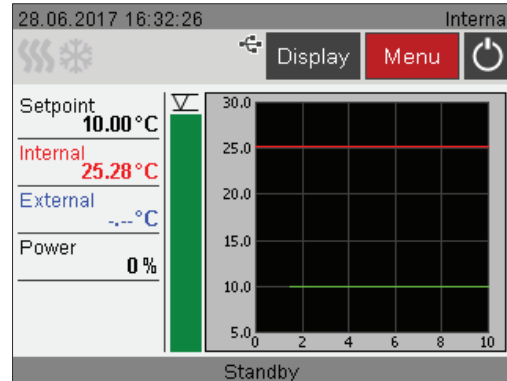

The following can be selected in the main menu



- - Settings
- - Record data
- - Thermodynamic
- - Adjust safety
- - Use programmer
- - Connect unit
- - Service
- - Install unit.

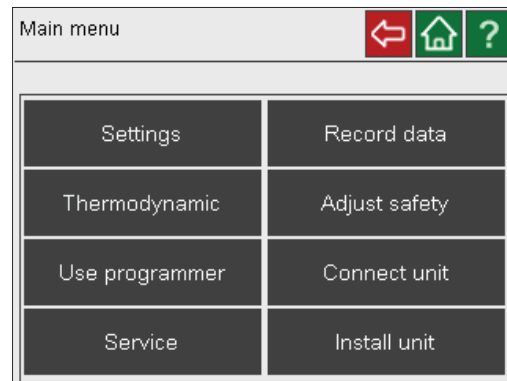

15.1 Applying settings

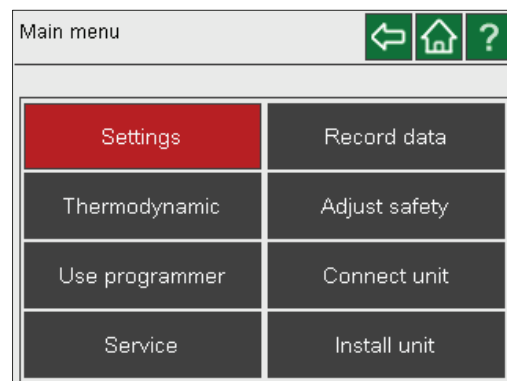

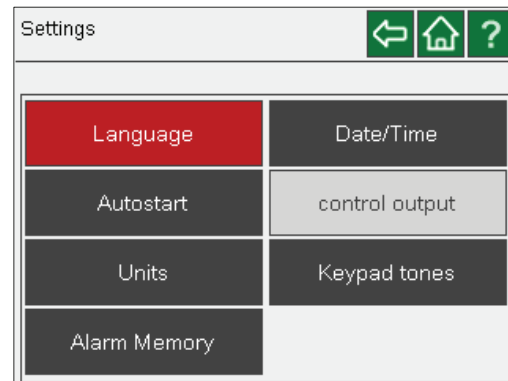

Selecting language

Setting the language  is already described in chapter "Switching on."

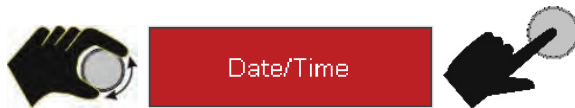

Setting date/time



Date and time can be set with  and . Dates can be shown in different formats.

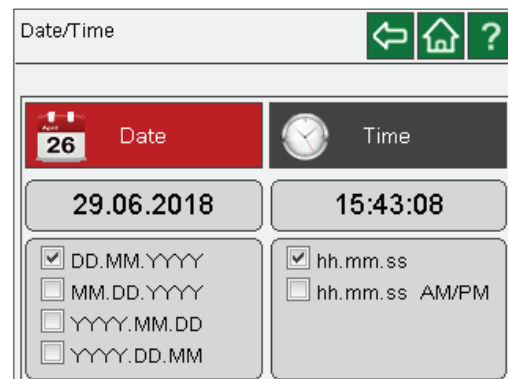
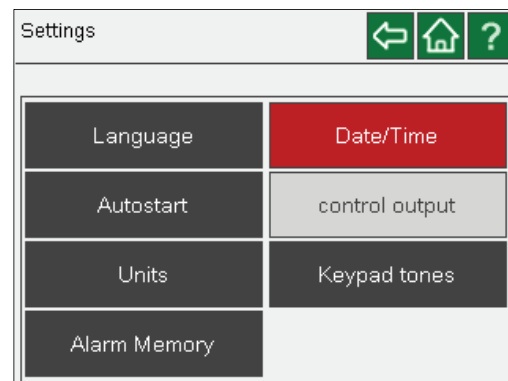

Selecting autostart



Allows starting the circulator directly using the mains switch.

The circulator is configured and delivered by JULABO according to the NAMUR recommendation. For starting this means that the unit must be switched into a safe operating status after a power failure (autostart "off"). This safe operating status is indicated on the display with "OFF". The main function elements refrigeration aggregate, heater, and pump motor are disconnected from the mains voltage.

The AUTOSTART function can only be executed with a specified setpoint via >Setpoint< and >EPROG input<.

If such a safety standard is not requested, the NAMUR recommendation can be bypassed with the AUTOSTART function (autostart "on"). This allows starting the circulator directly using the mains switch or via a timer.

Select  the desired operating mode and confirm .

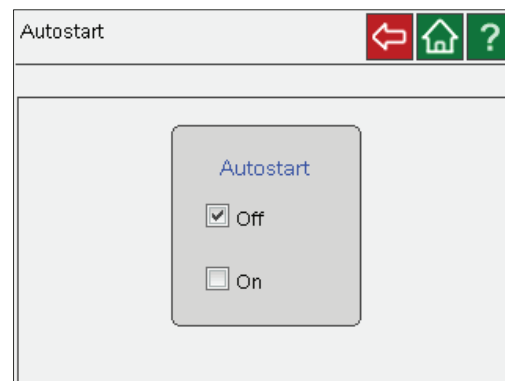
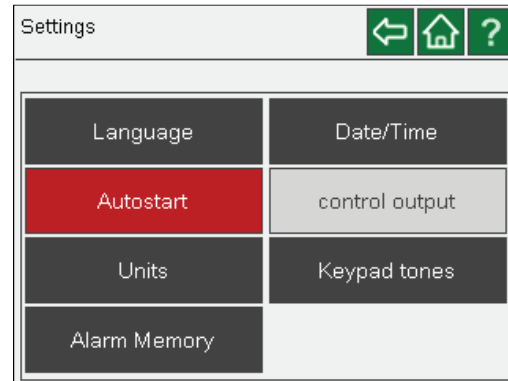

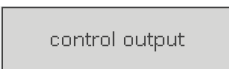
The  adjustment is not implemented in the DYNEO.

Adjusting physical units



Select the desired physical parameter and unit and confirm .

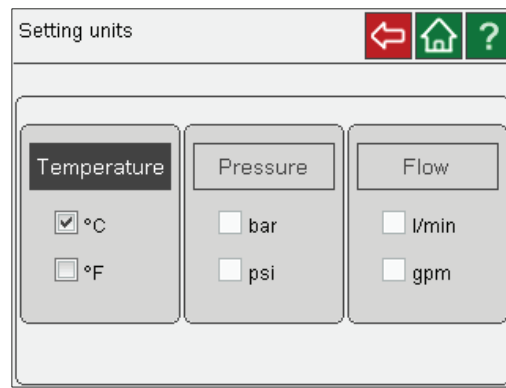
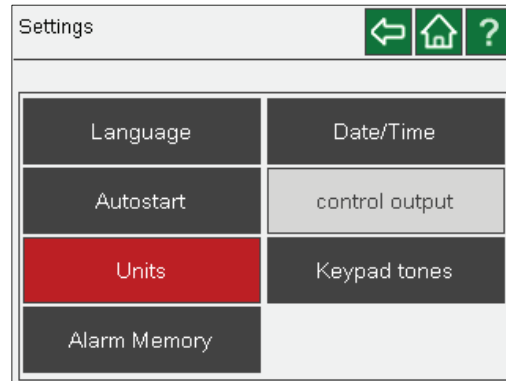

Reading out the alarm memory



The stored alarm messages are listed with date, time, alarm code and unit identifier.

The data is cleared using

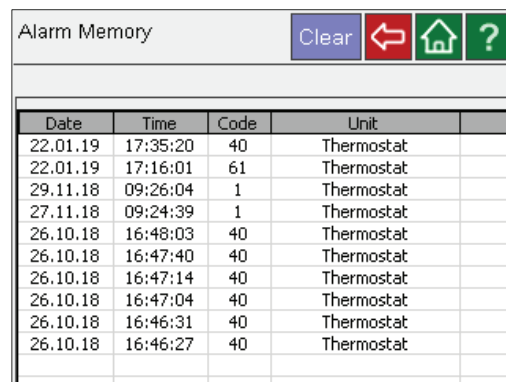
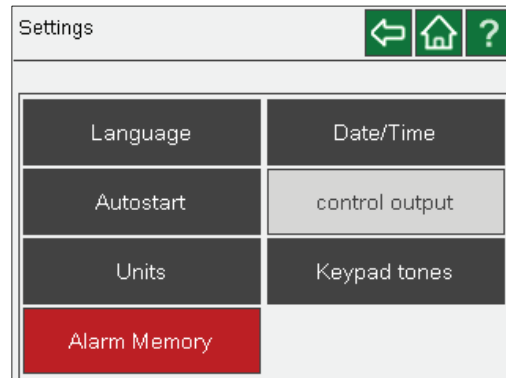

Keypad tones on/off

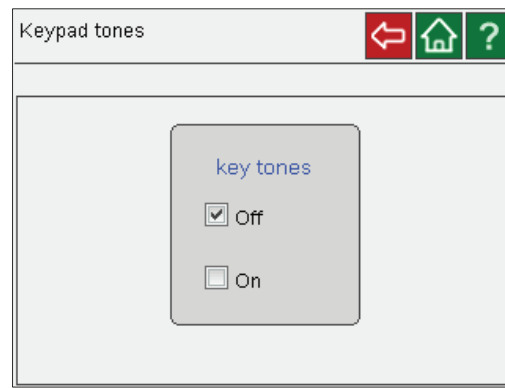
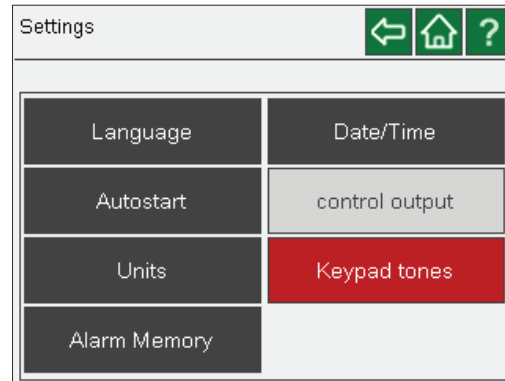
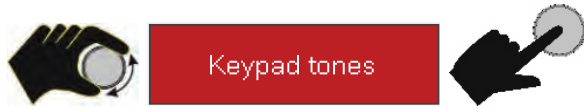

15.2 Thermodynamic

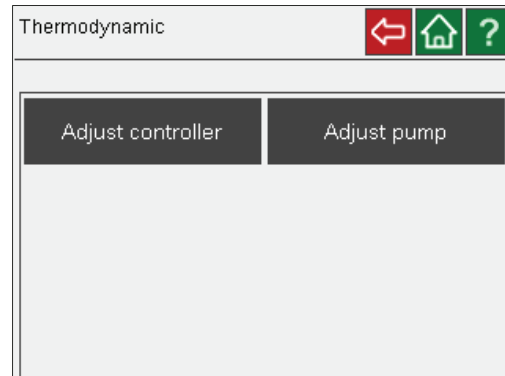
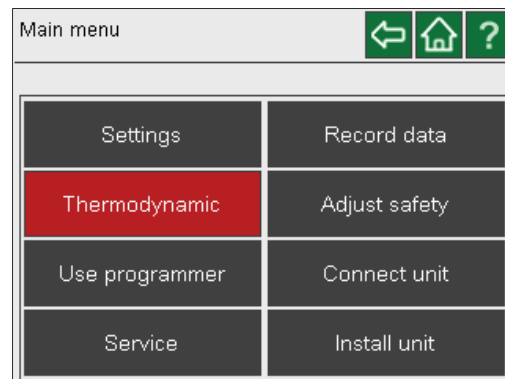
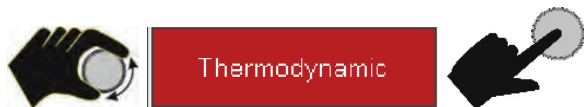

Adjust controller

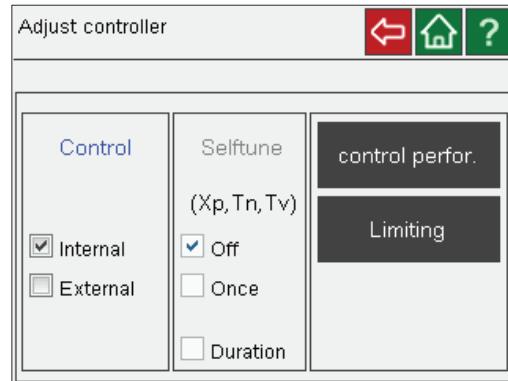
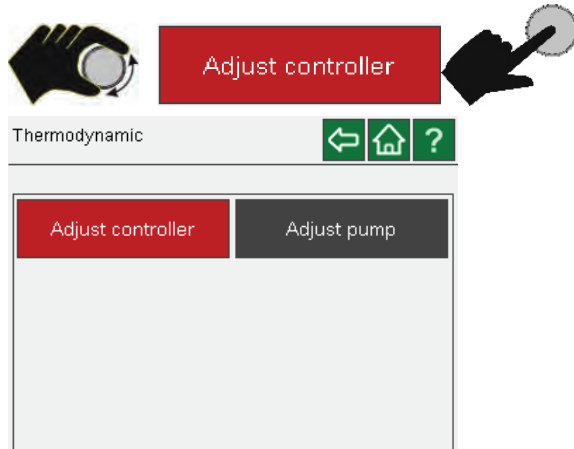

Control

The DYNEO models offer temperature control in the internal heat exchanger or external control in the consumer (loop circuit).

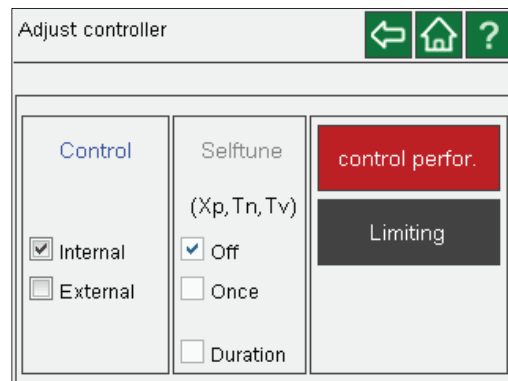
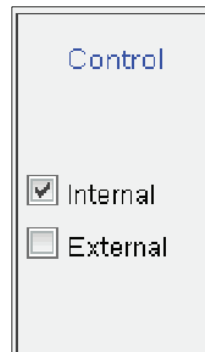
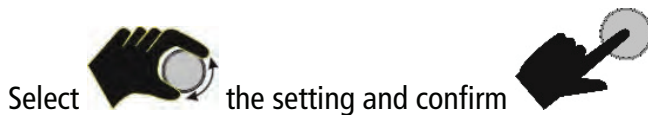



Internal parameters – external parameters

In the most cases, the factory-set control parameters are sufficient to achieve an optimum temperature sequence in the samples.

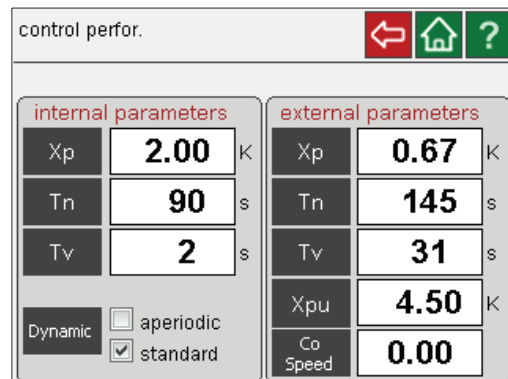
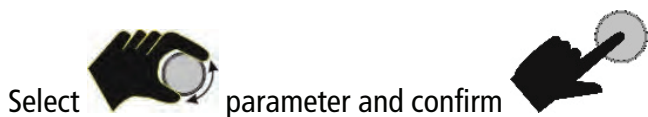
The adjustable control parameters enable an adjustment to special controlled processes.



Adjust  value and confirm 

Proportional range >Xp<

The proportional range is the temperature range underneath the setpoint,, in which the heating capacity is controlled from 100 % to 0 %.

Xp K

Integral time >Tn< (integral portion)

Compensation for the residual control deviation caused by the proportional controller. Too short integral times can lead to instabilities. Too long integral times unnecessarily extend the control difference compensation.

Tn s

Derivative time >Tv< (differential portion)

The differential portion shortens the settling time. A too short derivative time extends the transient compensation and leads to large overshooting during start-up. Too long derivative times can lead to instabilities (oscillations).

Tv s

 Dynamic 

Adjustable parameters:

This parameter influences the temperature sequence only with **internal** control.

Aperiodic

The temperature increase is temporally offset without overshoots.

Dynamic aperiodic
 standard

Standard

The temperature increase is faster, however, overshooting of up to 5 % may occur. If a ramp is defined, the temperature sequence mostly follows this ramp.

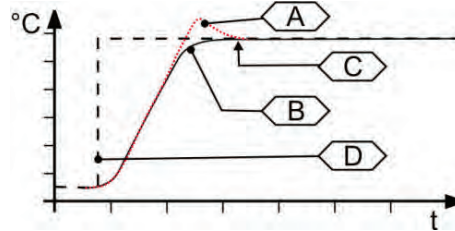

For both settings, sufficient temperature stability is achieved after approx. the same time.

- A Standard
- B Aperiodic
- C Constant temp.
- D Setpoint
- E Temperature ramp

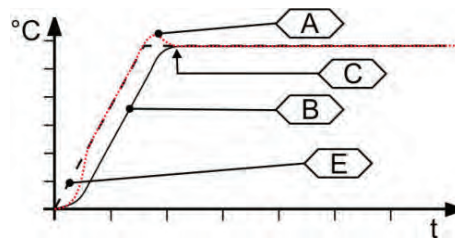

Proportional range >Xpu<

The proportional range Xpu of the underlying controller is required for **external control only**.

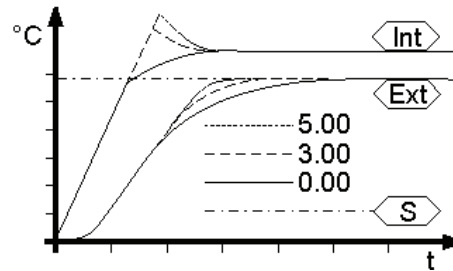

>CoSpeed Factor<

This parameter influences the temperature sequence only with **external** control. The setting influences the calculation of the control parameters during identification, and thus the control behavior.

S Setpoint
Ext Ext. temp.
Int Int. temp.

Optimization information for PID control parameters

The temperature sequence over time of the samples provides information about possible incorrect control parameter settings.

- optimally adjusted

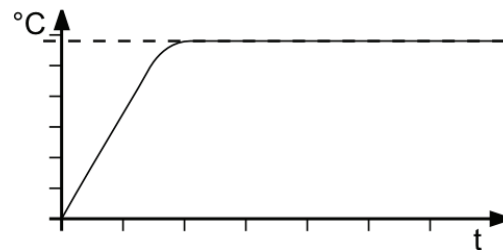

Incorrect settings can lead to the following heating curves:

Xp too small

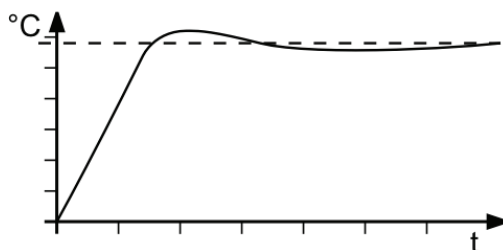

Tv/Tn too small

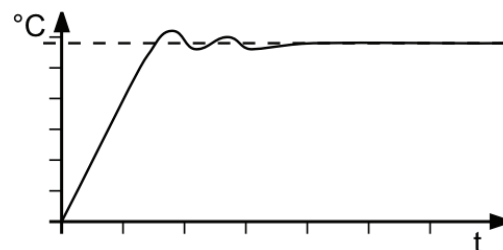

Xp too big or Tv too big

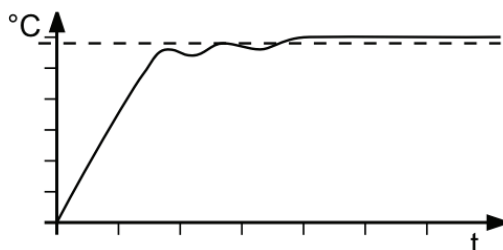

Tv/Tn too big or Xp too big

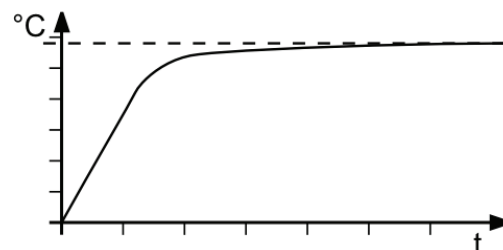

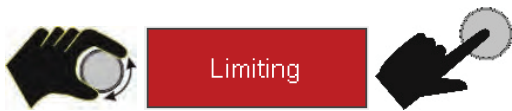

In the >Limiting< menu, the minimum and maximum values can be defined for all important setting ranges and performance parameters.

To adjust the values:

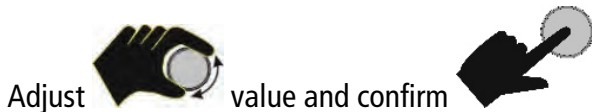

Max. cooling capacity/max. heating capacity

The heating and cooling capacity of the unit are adjustable. 100 % correspond to the capacities specified in the technical data.

Setting range:

Maximum heating capacity from 0 to 100 % in 1 % steps

Maximum cooling capacity from 0 to 100 % in 1 % steps

Internal minimum/internal maximum

Maximum and minimum setpoint in the internal bath.

The internal maximum and internal minimum limits are only effective in external control operating mode. Using internal maximum and internal minimum, static limits are defined for the temperature to be expected. The temperature controller cannot exceed these limits, even if this would be required for the temperature in the external system. Under certain circumstances, this can result in the external preset value not being achieved.

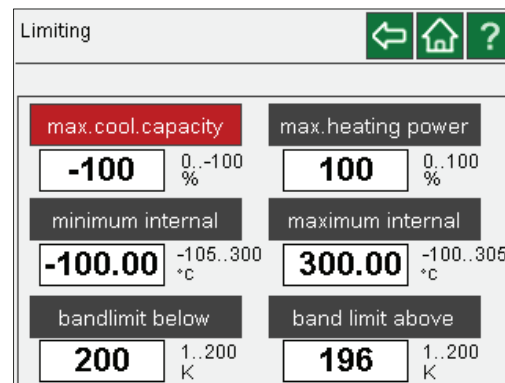
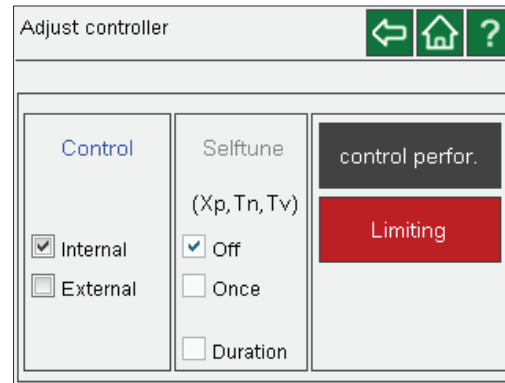
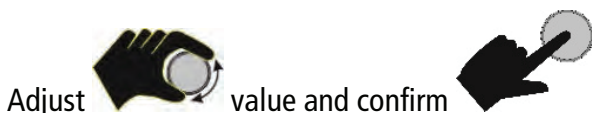

Meaning of the limit:

- Protection of the bath fluid from overheating.
- Protection from unintended alarm cut-off by the high temperature cut-off >Error 14<
Set the value of >internal maximum< at least 5 °C below the value of the >TANK< high temperature cut-off.
- Protection of the pump motor from too high viscosity of the bath fluid at low temperatures.

Band limit below and band limit above

The band limit is active with external control. Different, practice-oriented settings are possible for the heating and cooling phase.

Setting range: 0 °C ... 200 K

Using **> band limit above <** and **> band limit below <**, maximum permissible temperature differences between the internal bath and the external system are defined for the heating and cooling phase.

This difference value is always added to the current external temperature during the heating phase. In the cooling phase, the difference value is subtracted.

As long as **>selftune band limit <** is active, the band limit is switched off for external control.

As long as **>selftune band limit <** is active, the band limit is switched off for external control.

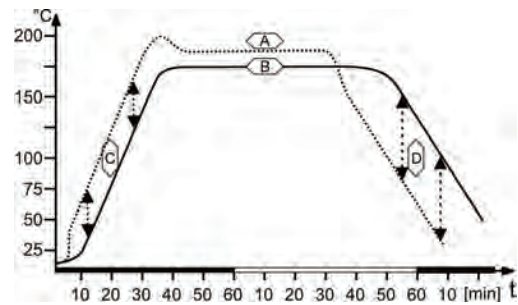

Legend:

A = Internal bath

B = External system

C = Band limit above

D = Band limit below

Meaning of the limit:

- Protection of the sample through gentle temperature control application.
- Protection of, e.g., glass reactors from thermal stresses.

Adjust the pump

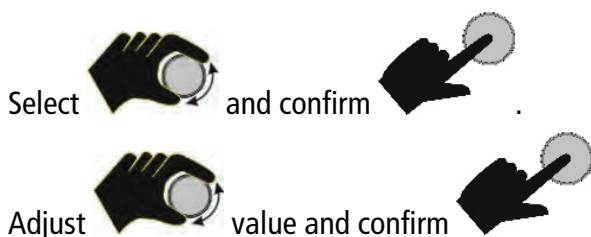
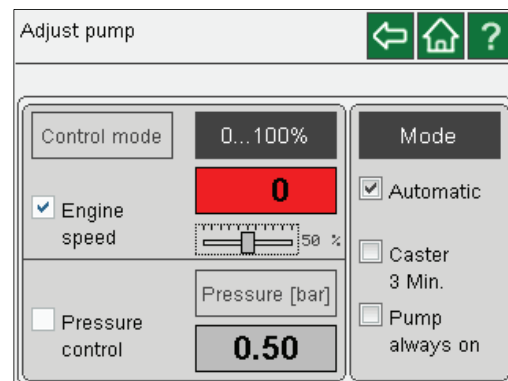
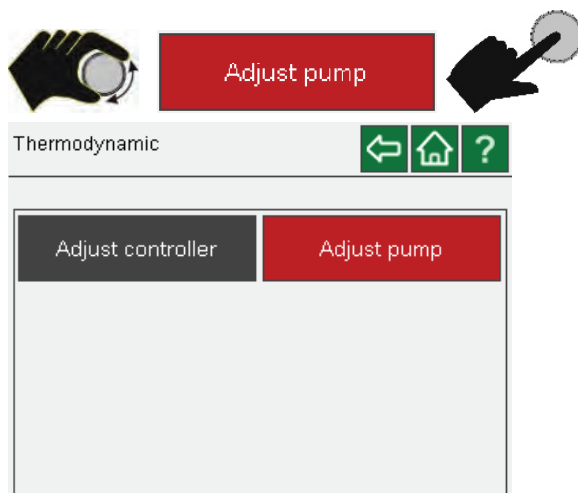

The delivery volume of the pump can be adjusted using the motor speed or the pressure. Regardless of that, the pump runs:

- Automatically (Auto),
- With a 3 min after-run,
- Always (pump always on)

15.3 Use programmer



Using programmer, setpoint temperature sequences can be quickly and easily programmed. Such a temperature sequence is referred to as profile. A profile is compiled of individual steps. The steps are defined using duration (t:) and gradient (°/t) and target temperature.

The target temperature is the setpoint temperature, which is reached after completing a step. Based on the time and temperature difference in a step, the programmer calculates a temperature ramp (1).

Caution:

If the time specified is too short, the actual temperature cannot reach the setpoint temperature. For this case, the programmer can be used to edit a profile.

If the time for a step is defined as 00:00:00, the setpoint temperature "jumps" (2) to the target temperature.

Only after the specified temperature is reached (± 0.2 °C), the profile is continued with the next step.

Eight profiles with up to 60 steps each can be stored.

The **Standard** or **Gradient** settings can be mixed in a profile.

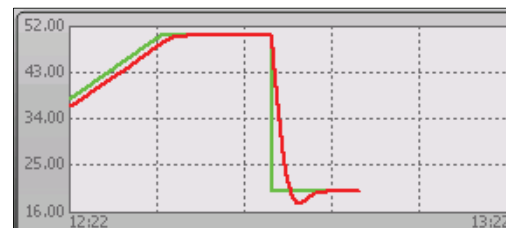
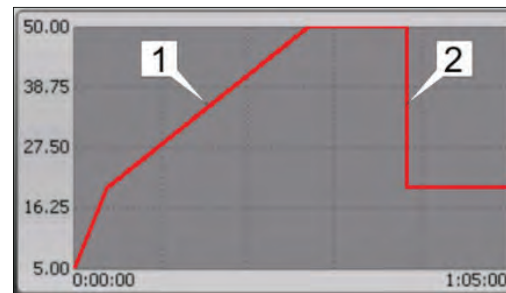
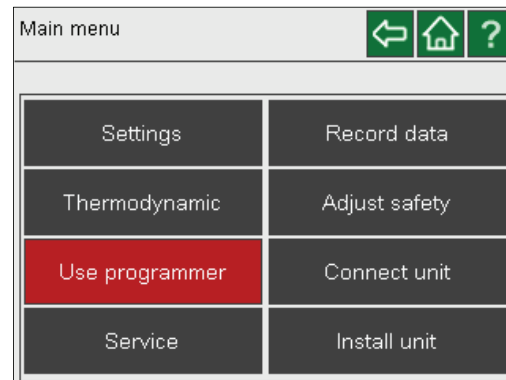

Setpoint = green

Actual value = red

Timer

Using the timer, the setpoint temperature is adjusted at a certain time for a certain duration of the temperature control application.



Select temperature, time, and duration and confirm .

Adjust values and confirm . The timer is activated by setting the checkmark



Profile timer

Using the profile timer, up to eight temperature sequences can be adjusted. Call up the desired profile (e.g.,).



start time, start date or number of profile

passes, and confirm .

Adjust values and confirm .

At the end of a profile, the unit is set into a selectable, definable final state:

- In standby (OFF),
- Temperature to last setpoint value,
- Temperature to start setpoint value

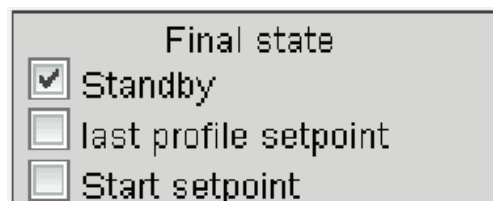
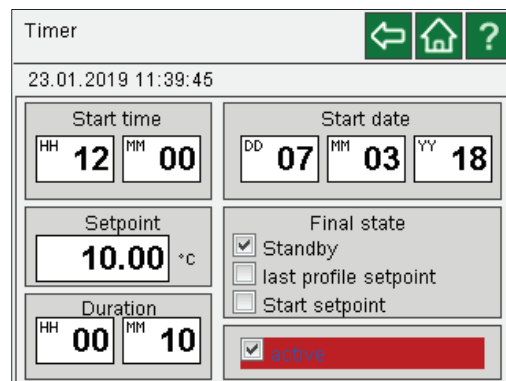
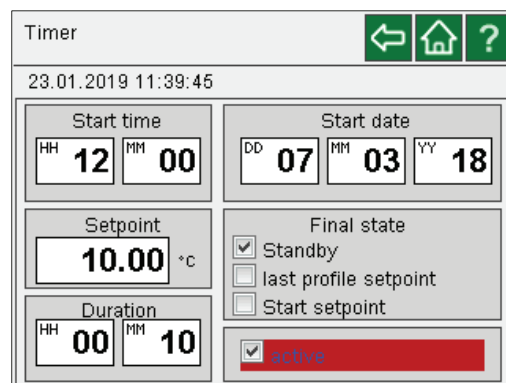
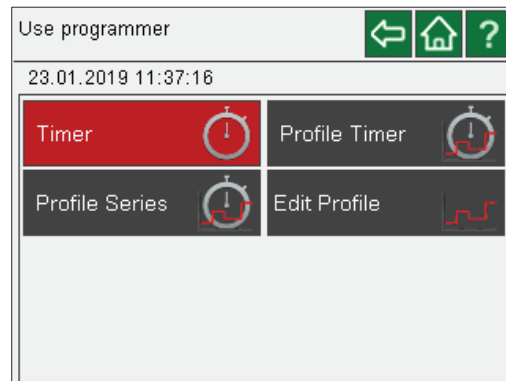

Set checkmark for the desired final state. With activation of the adjusted profile, it is executed using the specified data.



Exemplary creation/editing of a profile

The profile can be called up in the profile timer and changed as well.

The profile can be directly changed via the



button.

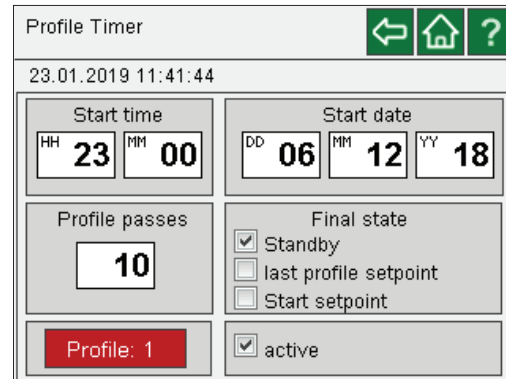

Select the profile no.

and confirm

Or

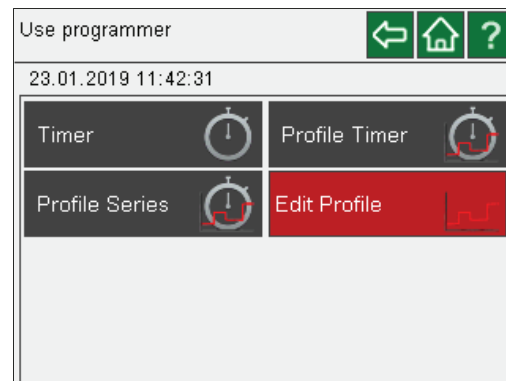

Of the 8 profiles, the selected profile is red.

Select "Edit" and confirm .

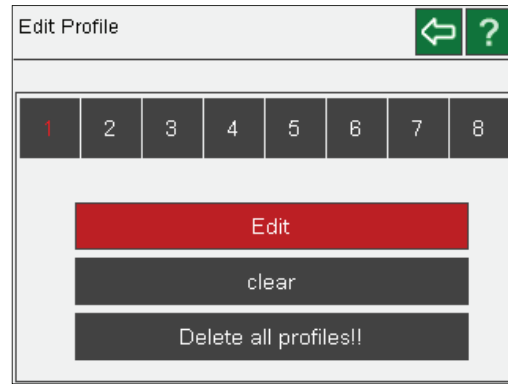

To create a profile, select "Add" and confirm . A preset line (step) is inserted.

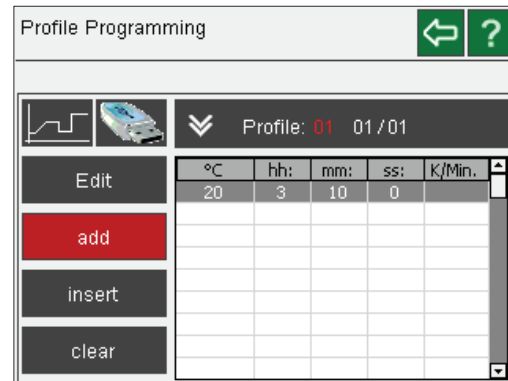

To change, select "Edit" and confirm . Columns °C, hh, mm, ss, K/MIN can be selected and adjusted after confirming .

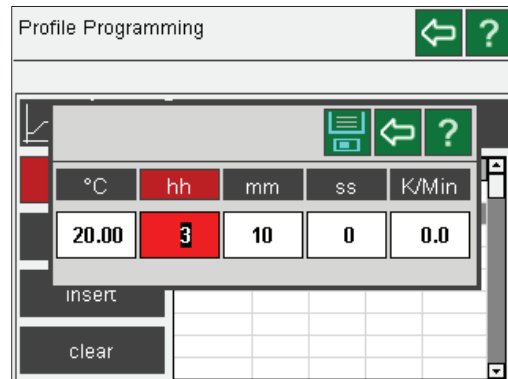

. Thus, the setpoint (°C), duration in hours (hh:), minutes (mm:), seconds (ss:) and the temperature gradient (K/Min.) can be adjusted in every step.

If a temperature gradient is entered, the time is set to zero. To store the adjusted values, select

the button and confirm . Saving is confirmed with "Successfully completed."

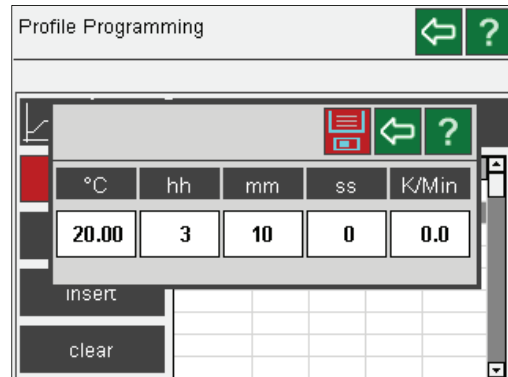

To confirm successful saving, press OK .

To add another profile line, select "Add" and confirm .

Another preset line is inserted. The line is highlighted

in gray. To edit the values, select  "Edit"

and confirm  . To insert a line, select

 " and  confirm  . The step is highlighted in red. Select the insertion point

 and confirm  (step is

highlighted in gray). Select  the "Insert"

button and confirm  . A line (with preset values) is inserted below the selected line.

This way, up to 60 steps can be created.

To remove, select  step with  and

confirm  (step is highlighted in gray).

Select  the "Clear" button and confirm

To edit a step, select via   .

The selected step in the profile is highlighted in red.



By confirming  , the step is highlighted in



gray and can be changed via 

Save

Successfully completed

OK

Profile Programming  



  Profile: 03 07/07



	°C	hh:	mm:	ss:	K/Min.
Edit	30	0	4	0	
add	20	0	10	0	
insert	40	0	10	0	
clear	20	0	10	0	
	20	0	10	0	
	20	0	10	0	

From display

 Profile: 03 04/07

profile no. (03), selected step (01), and total number of steps (07) in the profile can be obtained.

Profile Programming  

  Profile: 03 03/07

	°C	hh:	mm:	ss:	K/Min.
Edit	30	0	4	0	
add	20	0	10	0	
insert	40	0	10	0	
clear	20	0	10	0	
	20	0	10	0	
	20	0	10	0	



Profile Programming

Profile: 03 03/07

	°C	hh:	mm:	ss:	K/Min.
Edit	30	0	4	0	
	20	0	10	0	
add	40	0	10	0	
	20	0	10	0	
insert	20	0	10	0	
	20	0	10	0	
clear					

Profile Programming

Profile: 03 01/07

	°C	hh:	mm:	ss:	K/Min.
Edit	20	0	10	0	
add	20	0	10	0	
	20	0	10	0	
insert	20	0	10	0	
	20	0	10	0	
clear	20	0	10	0	

Another step can be added to the profile.



Or inserted.



Profile Programming

Profile: 03 07/07

	°C	hh:	mm:	ss:	K/Min.
Edit	30	0	4	0	
add	20	0	10	0	
	40	0	10	0	
insert	20	0	10	0	
	20	0	10	0	
clear	20	0	10	0	

Profile Programming

Profile: 03 04/07

	°C	hh:	mm:	ss:	K/Min.
Edit	30	0	4	0	
add	20	0	10	0	
	40	0	10	0	
insert	20	0	10	0	
	20	0	10	0	
clear	20	0	10	0	

Individual steps can be deleted:



Select step via



and to delete



Profile Programming



Profile: 03 05/08

	°C	hh:	mm:	ss:	K/Min.
Edit	30	0	4	0	
add	20	0	10	0	
	40	0	10	0	
insert	20	0	10	0	
	20	0	10	0	
clear	20	0	10	0	

The profile can be shown graphically. Select the



Profile Programming  



  Profile: 03 05/08

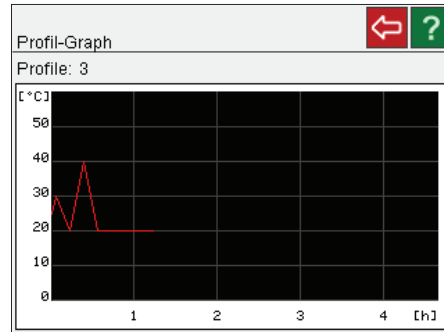

	°C	hh:	mm:	ss:	K/Min.
Edit	30	0	4	0	
add	20	0	10	0	
insert	40	0	10	0	
clear	20	0	10	0	
	20	0	10	0	
	20	0	10	0	
	20	0	10	0	
	20	0	10	0	





You can save the created profile or load saved



Profile Programming  

  Profile: 03 05/08

	°C	hh:	mm:	ss:	K/Min.
Edit	30	0	4	0	
add	20	0	10	0	
insert	40	0	10	0	
clear	20	0	10	0	
	20	0	10	0	
	20	0	10	0	
	20	0	10	0	
	20	0	10	0	

Profile...  



load Profile save profile

To load:

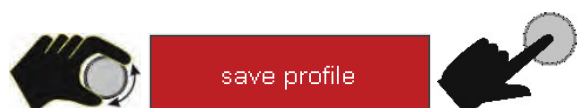

To save:



Profile...  

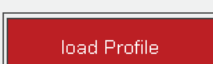
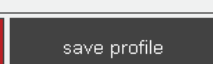

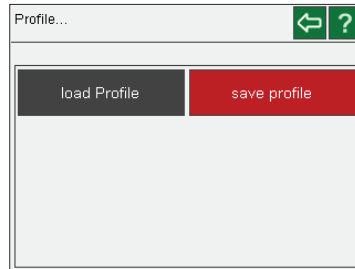
Profile series

Using the profile series, profiles can be started and ended selectively day by day over any time frames.

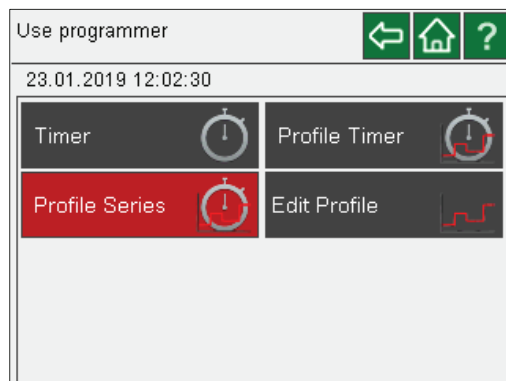

At the end of a profile, the unit is set into a selectable, definable final state:

- In standby (OFF),
- Temperature to last setpoint value,
- Temperature to start setpoint value.

Set checkmark for the desired final state. With activation of the adjusted profile, it is executed using the specified data.

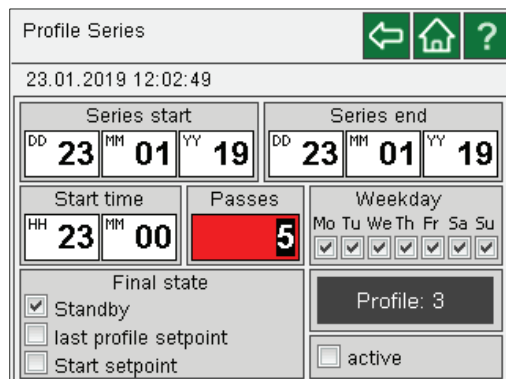

The profiles can be deleted selectively

clear or all by pressing a button. Select profile and delete or select



Delete all profiles!!

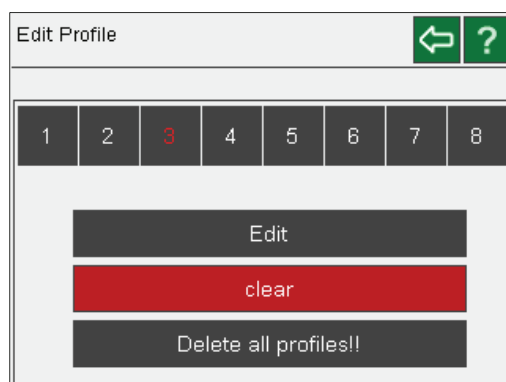



and confirm. All profiles are deleted.

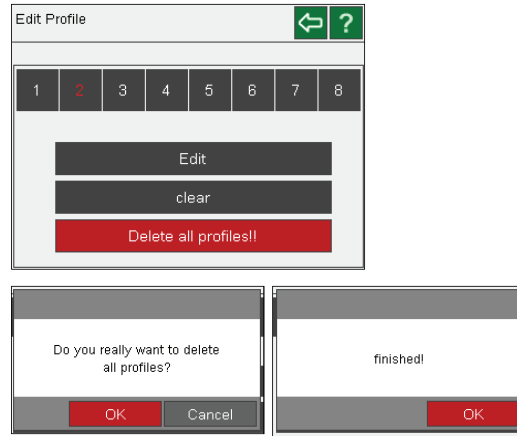

15.4 Connecting unit with PC

Select in the main menu:

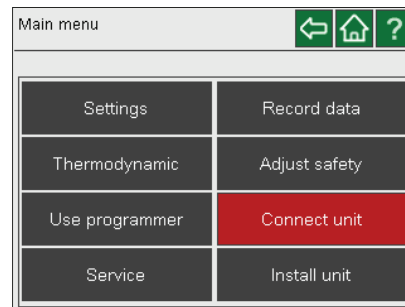

The control type of the unit as well as the type of actuating value specification are adjusted here.

The settings of the digital and analog interfaces can be adjusted as well.

Remote control

The unit can be remote-controlled via RS232 or USB interface. If the USB interface is selected, values such as the internal temperature can be read out via RS232. However, unit settings can only be adjusted via the selected interface.

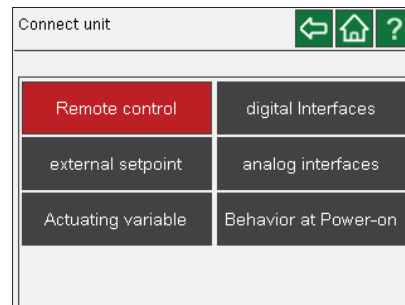

For this purpose, select the desired setting

- Off (no remote control)

- USB

- RS232

(checkmark). In the display, this is indicated in the status line with an "R" and in the display with R-OFF.

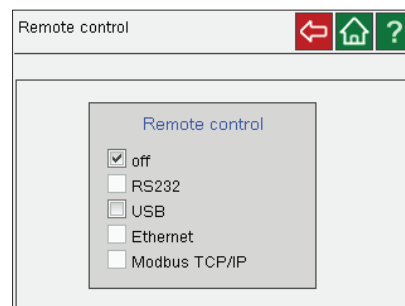

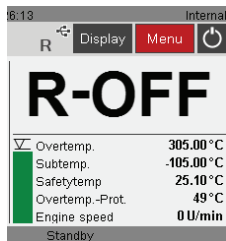

Ethernet and Modbus TCP/IP are not implemented.

External setpoint

In addition to remote control via the serial interface, the unit also supports external setpoint specification via the analog interfaces >ext. PT100< or >EPROG<.



- Off

Setpoint adjustment on the unit or via programmer

- PT100

Setpoint adjustment via analog interface EXT PT100 through an external temperature sensor or a voltage/current source.

- EPROG

Setpoint adjustment via analog interface REG+EPROG through an external programmer.

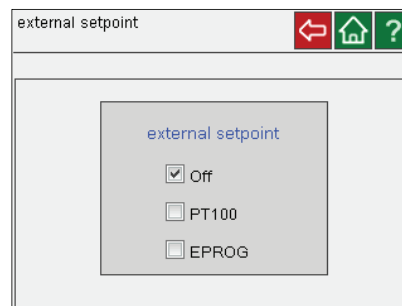
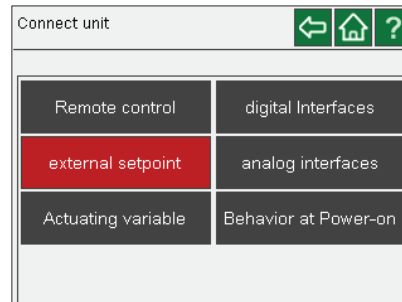

Digital interfaces (option)

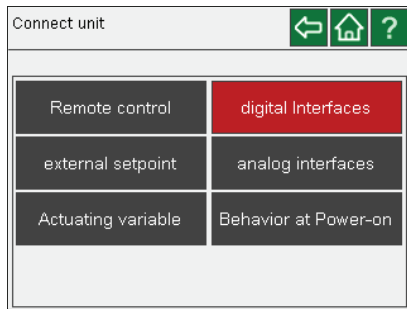

The parameter settings of the RS232 interface must be made in this menu.

Select settings of the interface.



and confirm.

Parity:

non, uneven, **even***

Baud rate [Baud]:

1200	19200	2400	38400
4800*	57600	9600	115200

Handshake:

non, Software-, **Hardware-***

Data bits 7, Stopbit 1

* Factory setting

Pin asignment

Pin 2	RxD	Receive Data
Pin 3	TxD	Transmit Data
Pin 5	0 V	Signal GND
Pin 7	RST	Request to send
Pin 8	CTS	Clear to send

Pin 1, 4, 6, 9 are reserved, not for use.

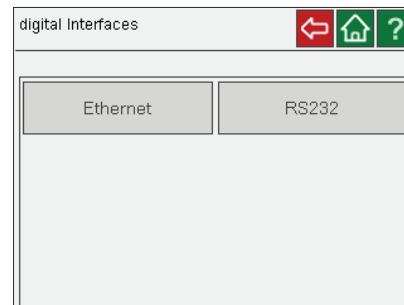

Connect unit and PC using a RS232 interface cable.

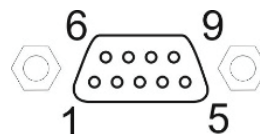
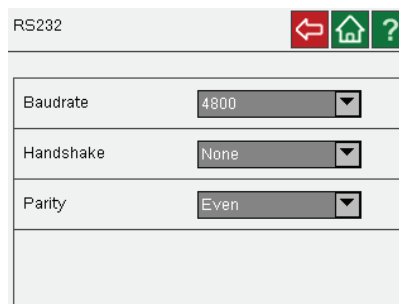

Analog interfaces (option)

The analog module has three circular female connectors.

1. Alarm – Output for an external alarm signal
2. Female connector **REG+E-PROG** with three logging outputs and one input for an external programmer or other voltage and/or current sources.
3. Female connector **Standby** input external „off“-key).



Information regarding labeling:

Test For service purposes only. This key has no function during regular operation.

reset The module can be „reset“ with this key. This may be necessary in case of an error, for example if the red LED (error) lights up.

on ● **Green LED is illuminated**

The module has operating voltage but does not receive any information (CAN-Messages).

Green LED is not illuminated

The unit is turned off or the module is damaged or it has no power supply.

Green LED blinks

Irregular blinking indicates that the module receives information (CAN-Messages) and works correctly.

error ● **Red LED is illuminated**

Alarm of the module. The TFT display shows the type of error and required measures.

Red LED is not illuminated

If the unit is operating and the diode is not illuminated the module works correctly.

Red LED blinks

An unknown error has occurred during the data transfer on the CAN-Bus. The CAN-Bus has deactivated itself for safety reasons. Turn the unit off and then on again after several second. If the error occurs again, please contact JULABO service.

Using the "Analog interfaces" menu, the "Setpoint, internal, external, power" can be assigned to measurement values. This menu can only be selected, if the optional analog module is used and connected.

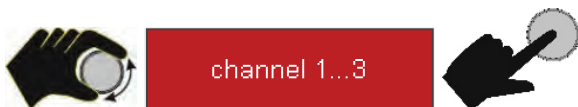
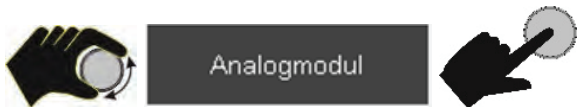

Channels 1 and 2 refer to the voltage output 0 V to 10 V.



For channel 3, the current outputs of 0 mA and 4 mA can be selected by ticking. The final value is 20 mA each

The setpoint, internal, external and the power can be set as input variables.

If the preset upper and lower values are to be retained, they must be explicitly confirmed after

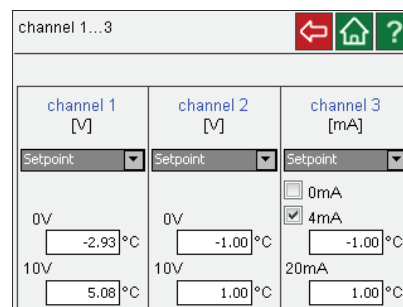
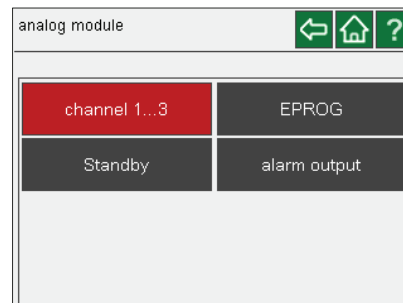
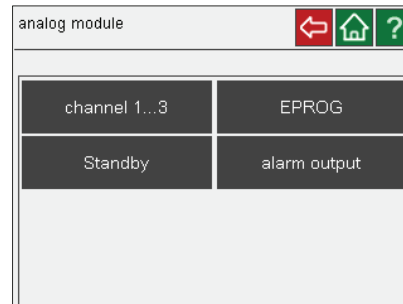
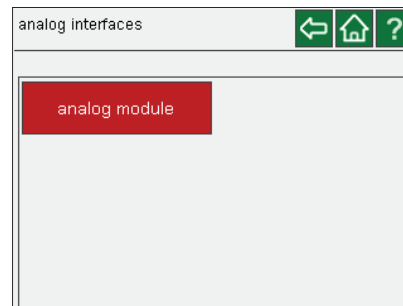
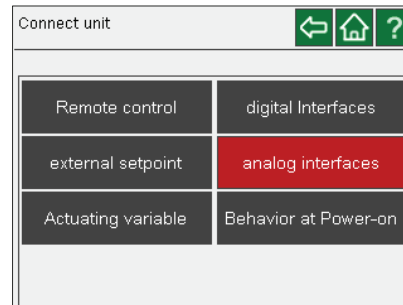
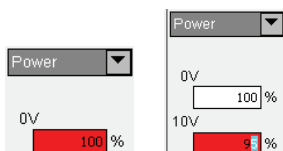
switching over by pressing .



Select  channel and confirm 

Adjust the input parameter (highlighted in red).

Adjust the corresponding temperature values for 0 V (lowest temperature value) and 10 V (highest temperature value).

Adjust value with  and confirm 

These steps are the same for the three channels.

 **EPROG** 

Using the EPROG setting, the input parameters

- Setpoint (in °C or °F)
- Power (in %)
- Flow (in LPM)

(with voltage and current signal types) can be evaluated.

For this purpose, the lowest measured value must be assigned to the lowest input value and the highest measured value to the highest input value.

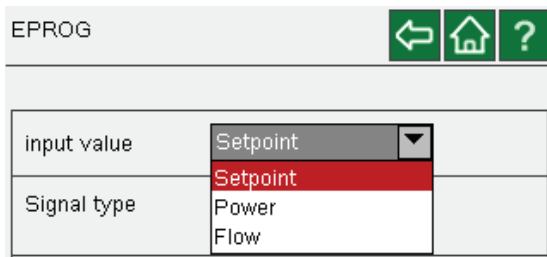

EPROG

input value	Setpoint
Signal type	Setpoint
	Power
	Flow

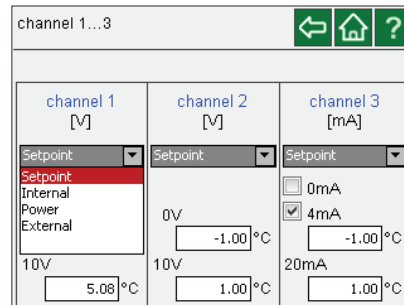

channel 1...3

channel 1 [V]	channel 2 [V]	channel 3 [mA]
Setpoint	Setpoint	Setpoint
Setpoint	0V	<input type="checkbox"/> 0mA
Internal	-1.00 °C	<input checked="" type="checkbox"/> 4mA
Power	10V	20mA
External	1.00 °C	1.00 °C

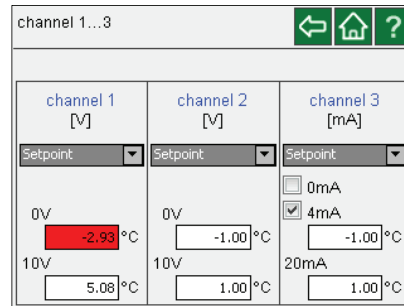

channel 1...3

channel 1 [V]	channel 2 [V]	channel 3 [mA]
Setpoint	Setpoint	Setpoint
0V	0V	<input type="checkbox"/> 0mA
-2.93 °C	-1.00 °C	<input checked="" type="checkbox"/> 4mA
10V	10V	20mA
5.08 °C	1.00 °C	1.00 °C

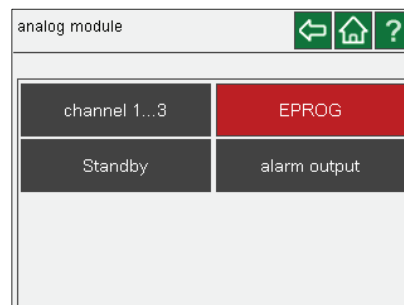

analog module

channel 1...3	EPROG
Standby	alarm output

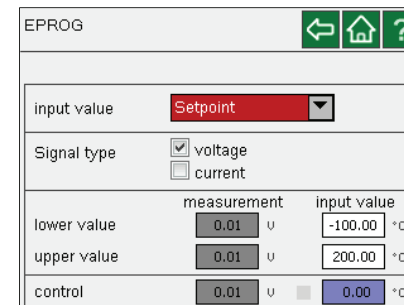

EPROG

input value: Setpoint

Signal type: voltage, current

	measurement	input value
lower value	0.01 v	-100.00 °C
upper value	0.01 v	200.00 °C
control	0.01 v	0.00 °C

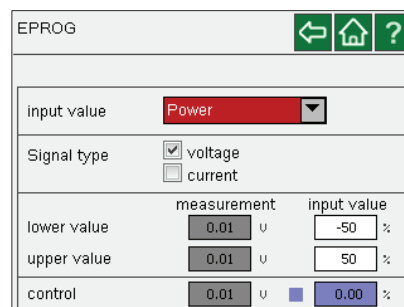

EPROG

input value: Power

Signal type: voltage, current

	measurement	input value
lower value	0.01 v	-50 %
upper value	0.01 v	50 %
control	0.01 v	0.00 %

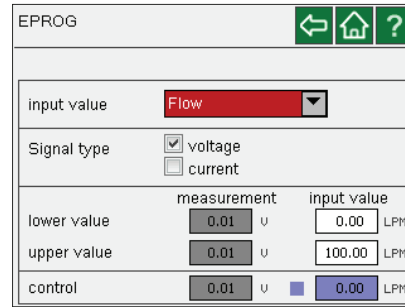

Consisting of three register outputs and one input for an external programmer:

- 1 Channel 1 voltage output 0..10 V
- 2 Channel 2 voltage output 0...10 V
- 3 Gnd for outputs 0 V
- 4 EProg programmer input. 0...10 V / 0...20 mA
- 5 Channel 3 current output 4...20 mA / 0...20 mA
- 6 Gnd for programmer 0 V

Assignment

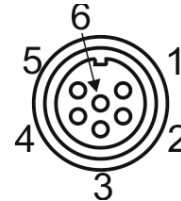

Only SELV-input (Safety Extra Low Voltage)



Activating stand-by input:

1. Adjust the parameter under the Standby menu item to **>active<**.
2. Establish the connection to an external contact (AK, e.g., external cut-off) or to an alarm contact of the superordinate system.

If the connection between pin 2 and pin 3 is interrupted through opening of the AK contact, the unit switches off heater, pump motor, and compressor and switches into "E-OFF" state.

If the contact is closed again, the unit remains in "External-OFF" state.

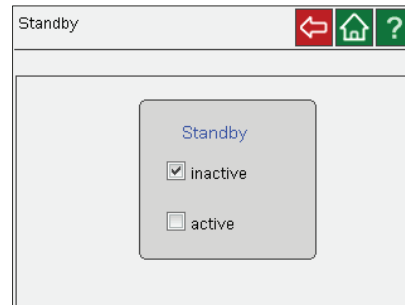
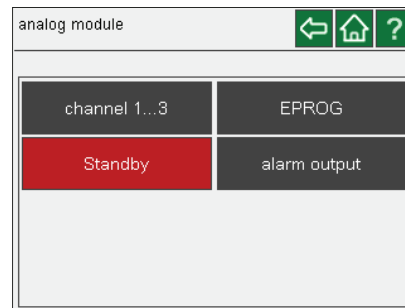

Principle:

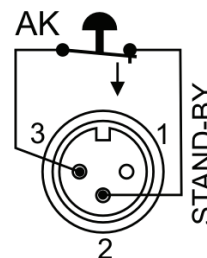

Alarm output for an external alarm signal.



The current setting is displayed on the keypad.

Switch power

max. 30 W / 25 VA

Switch voltage

max. 30 V_{DC}; max. 25 V_{AC}

Switch current

max. 1 A

This connection is realized as potential-free changeover contact. Without changing the plug connection, all operating statuses of the unit can be reported to the outside using the settings in the >Alarm output< menu.

Pin 2 and 3 are connected for the **Standby; Alarm; Alarm+Stdby** settings.

Pin 2 and 1 are connected for the Standby / Invers; Alarm / Invers; Alarm+Stdby / Invers settings.

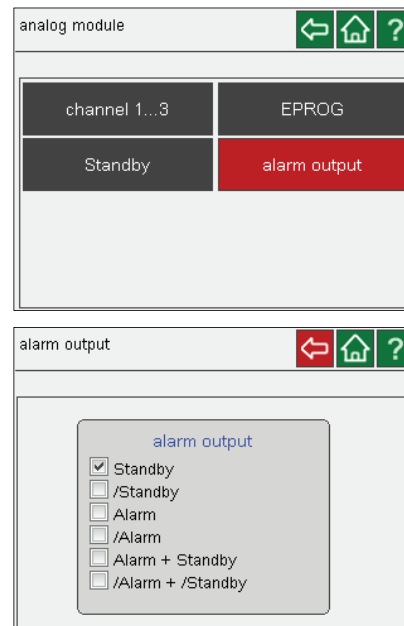

Principle:

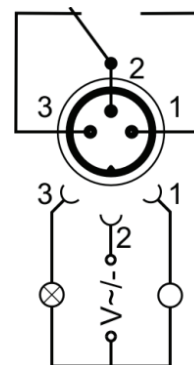

Actuating value specification

The actuating value is the measure used to actuate the heater or cooling unit of the temperature control system. Heat or coldness is introduced into the bath depending on this measure. If the control electronics of the unit, referred to as >controller<, is used, the bath temperature is adjusted to the adjusted setpoint and maintained consistently at this temperature.

Actuating value specifications in the >Digital< and >EProg< positions are only implemented if the unit is in start mode.

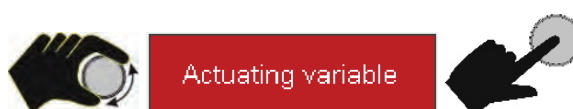

Controller

The internal control electronics of the unit controls heater and cooling unit.

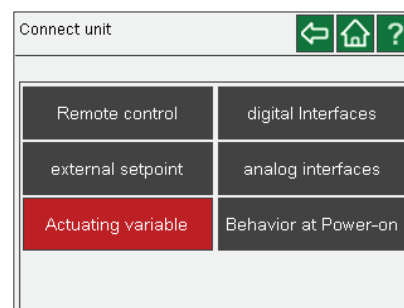

Digital

The heater or cooling unit receives the control signal via a digital interface
>RS232< / >USB< / >Ethernet<.

EProg

The heater or cooling unit receives the control signal via the EProg input.
- Can only be adjusted with the electronic module option.

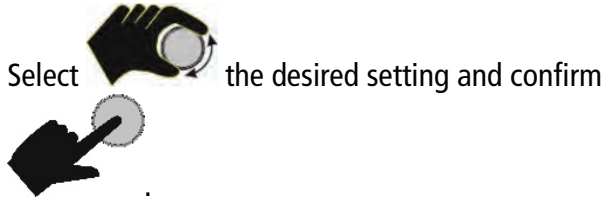

Behavior at Power-on

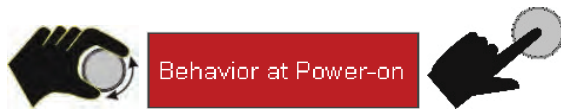

With Behavior at Power-on, values of the
- Manual settings
or
- Remote control can be applied.

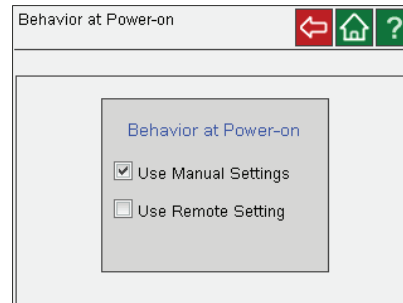
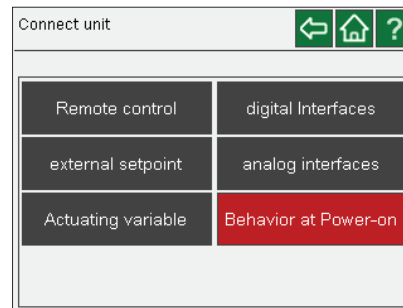
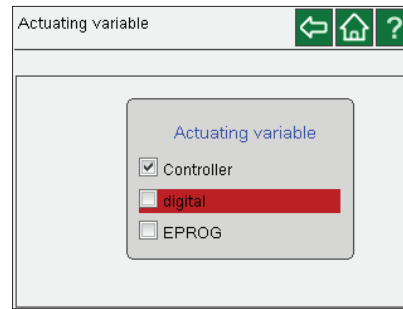

15.5 Install unit

Select



Install unit

in the main menu

and confirm



If the circulator is operated without refrigeration base units, the "Cooling mode" and "Power supply" menu fields are grayed out.

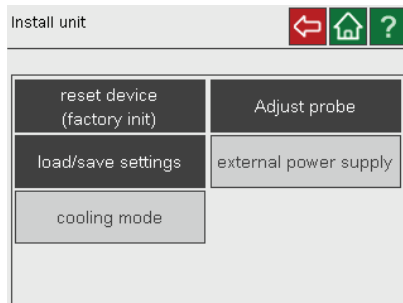
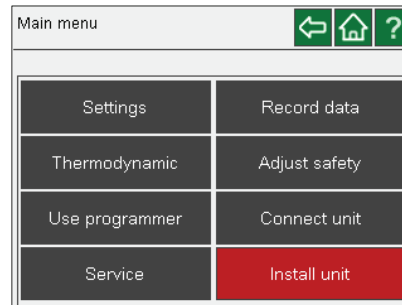

Reset device (factory init)

All adjustable unit parameters can be reset into the status at delivery.

Select



Reset device (factory init)

and

confirm

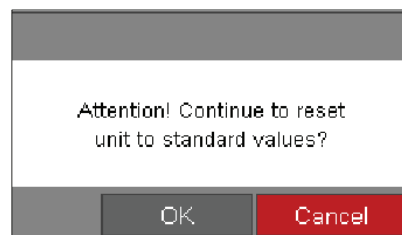
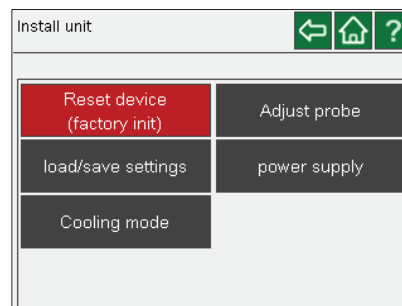

Adjust probe



The sensor (probe) is adjusted (calibrated) for the internal and an external temperature sensor in "inactive" mode. If the desired values are entered under "Cal.", switch to the desired mode and save with .

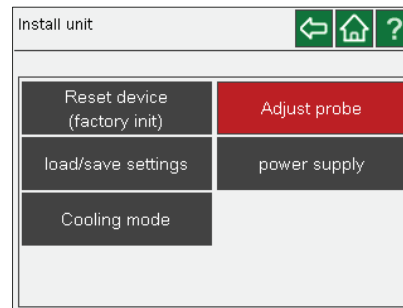

Principle: External sensor calibration

For sensor calibration in the external bath, the bath temperature is determined using a reference temperature sensor in the adjusted state.

This value is then adjusted on the temperature control system in the >Adjust probe< menu, in menu item > Cal.<.

A >1 point<, >2 point< or >3 point< calibration can be performed.

Select the desired number of curve points in Mode.

T_T 1 = original curve

In the case of 1-point calibration, the calibration curve is shifted towards the original curve of the sensor element overall.

In the case of 3-point calibration, a curve can be created. This can improve the accuracy of the temperature display in the range important for the application.

Proceed as follows to define the points:

1. Specify setpoint
2. Wait, until the specified setpoint is displayed.
3. Read out the temperature on the calibrated thermometer.
4. Enter the read-out value under Cal.

In the case of 1-point calibration, the calibration curve is shifted towards the original curve of the sensor element overall.

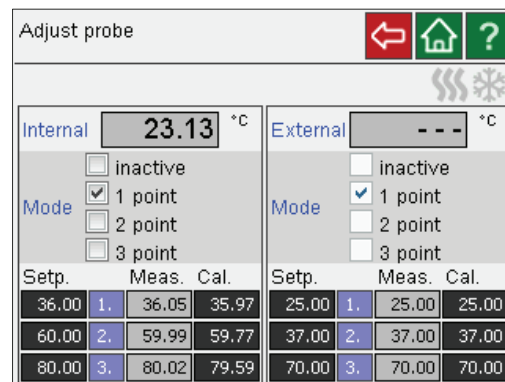

Examples:

1-point calibration

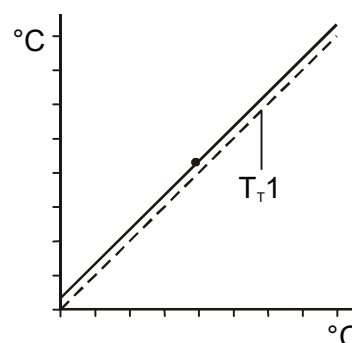

In the case of 3-point calibration, a curve can be created. This can improve the accuracy of the temperature display in the range important for the application.

3-point calibration

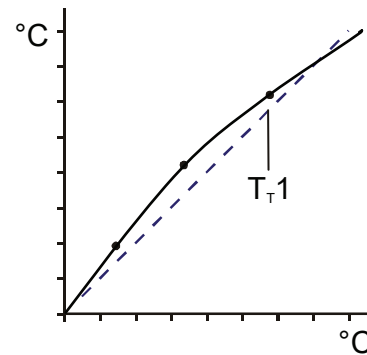

$T_T 1$ = original curve

1. Temperature control system
2. External Pt100 sensor
3. External bath
4. Temperature measuring instrument with reference temperature sensor

Read out the calibration value here.

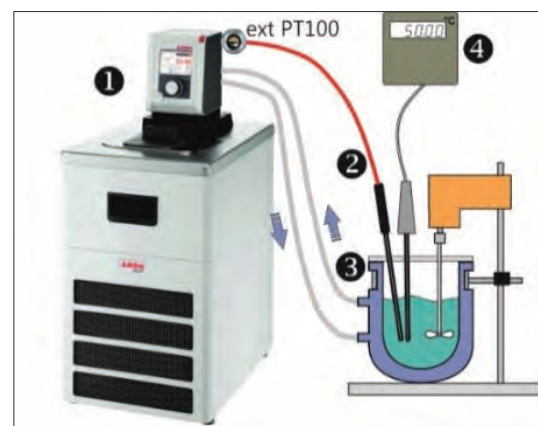

Preparation:

- Connect the external Pt100 sensor to the "EXT Pt100" port.
- Adjust the unit to >Internal control<.



Load/save settings

You can save adjusted values under an individual name on a USB stick and reload them as needed.

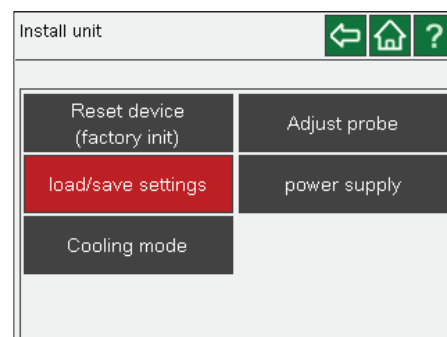

Apply the setting saved on the USB stick.

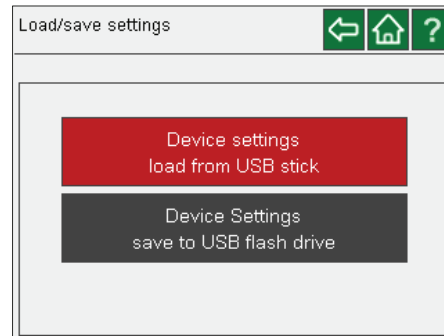

Save setting on the USB stick.

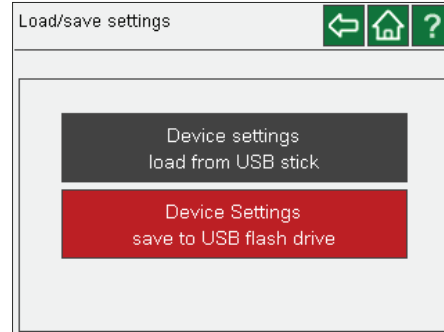

Cooling mode

The refrigeration unit operating mode can be adjusted.

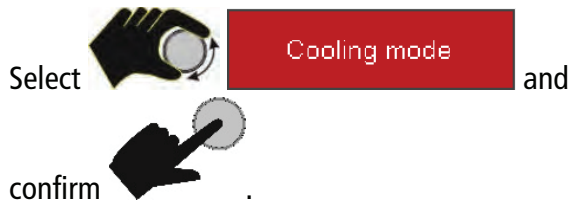

The following can be selected:

- **Automatic** (factory setting), if cooling capacity may be required.
- **Always on**, if cooling capacity is required for maintaining the bath temperature.
- **Always off**, if no cooling capacity is required.

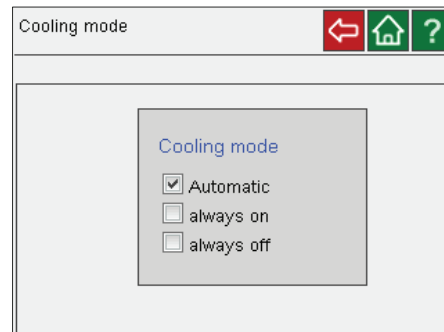
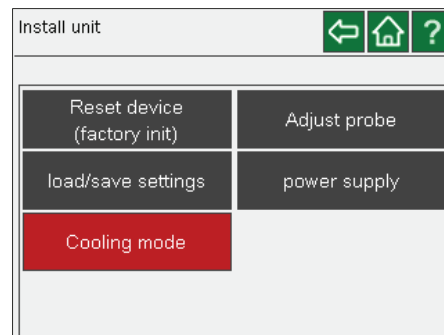

Power supply

The circulator is supplied with power via the refrigeration base unit. However, circulator and refrigeration base unit can be supplied separately.



Left selection: The circulator is supplied with voltage from the refrigeration unit.

Right selection: Circulator and refrigeration unit are supplied separately.

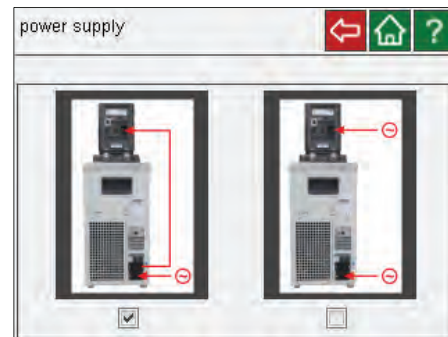
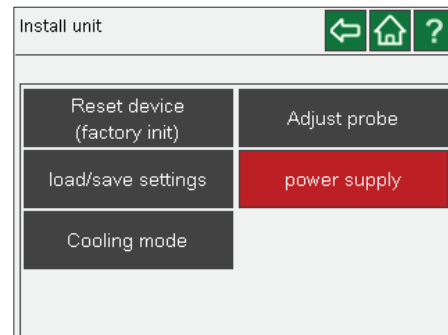

15.6 Record data

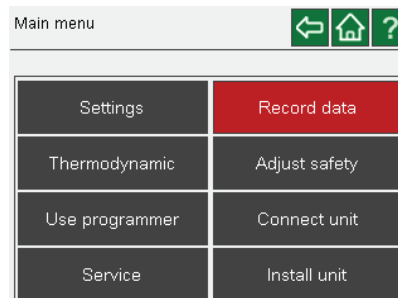
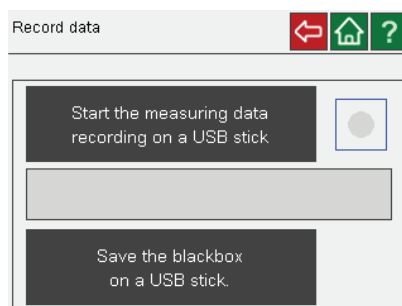
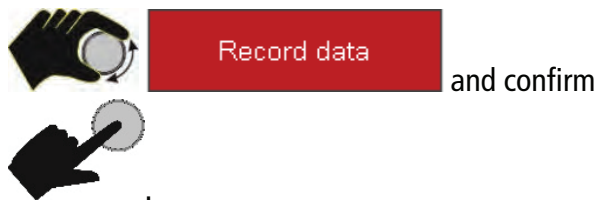

Insert a USB stick into the USB port on the back of the device. To record data in the main menu, select





Measuring data recording



The date, time, setpoint, internal, external, performance, status can be documented here

To prepare the recording select   and confirm. 

To set the sampling time   , set the desired value and confirm  .

The data series can be assigned an individual file name under which the data can be stored.

To start recording select   and confirm  .

A pulsating red dot indicates that the recording is in progress. To stop the recording select   and confirm  .

Store Blackbox on USB stick

JULABO DYNED units are equipped with a so-called "black box". It is integrated into the controller, where all relevant data of the most recent 30 minutes are recorded.

This data can be exported when servicing the unit. To

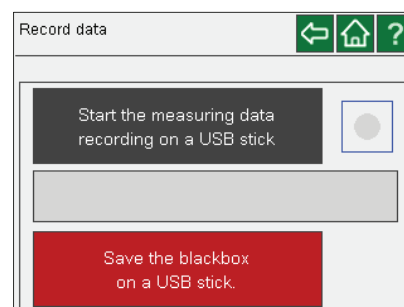
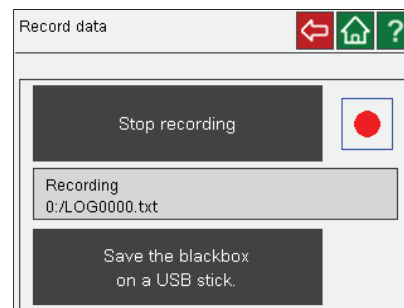
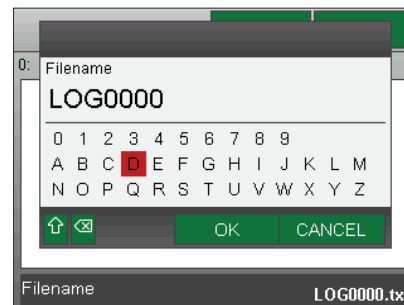
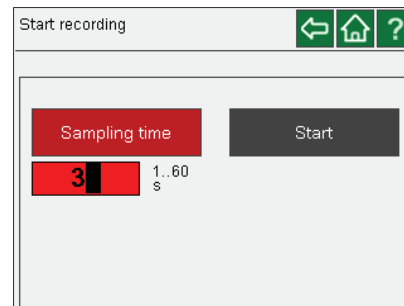
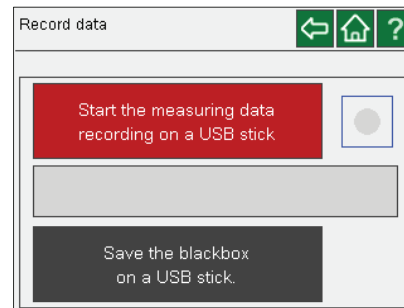

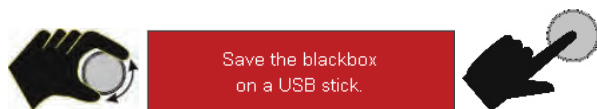

The blackbox data series can be assigned an individual file name under which the data can be stored.

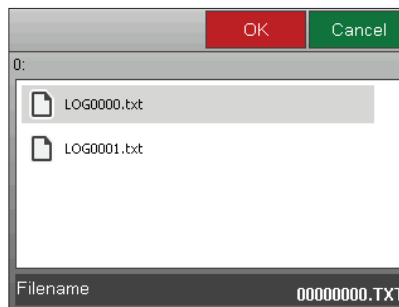

To save the recordet data select



15.7 Service

Select



menu and confirm

Access to the service menu is only granted to the JULABO Service team.

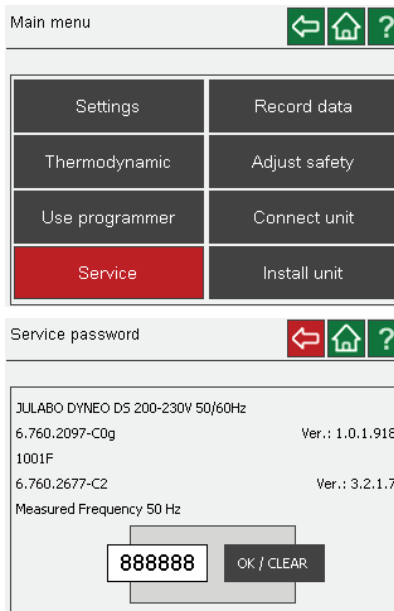

16 Emptying the bath tank



! WARNING

Danger of scalds from hot bath fluid or hot drain tap.

Please note the following when draining the bath fluid:

- Hot bath fluid:
Do not drain the bath fluid when it is hot.
- Environmental Hazard:
Refer to all regulations for disposing of bath fluids.



Emptying

- Switch off the unit and pull the plug or disconnect the connection to the power supply on all poles.
For baths without a drain tap, remove the circulator from the bath tank.
- Small bath tanks do not have a drain tap and can be carried for draining. The temperature of the bath fluid should not exceed 50 °C.

Enclosed baths and refrigeration machines

- Connect a suitable hose to the drain port (Ø 12 mm external).
- Route the hose to a vessel or drain.
- Open the drain valve with the knurled screw.



- ① To reduce the weight, the bath can be partly emptied using a hose pump (transfer pump).
- ① Do not empty the bath in temperatures of $\leq 0^{\circ}\text{C}$ since the drain tap may freeze.

17 Technical data

17.1 Technical data for circulator

Circulator		DYNEO™ DD
Working temperature range	°C	20 ... 200
Temperature stability	°C	±0.01
Temperature setting		digital
Temperature display		TFT
Resolution	°C	0.01
ATC - Absolute Temperature Calibration		3-point
Temperature control		PID3
Heating capacity (at 100 V / 50 Hz / 60 Hz)	kW	0.8
Heating capacity (at 115 V / 50 Hz / 60 Hz)	kW	1.0
Heating capacity (at 200 V / 50 Hz / 60 Hz)	kW	1.5
Heating capacity (at 230 V / 50 Hz / 60 Hz)	kW	2.0
Circulating pump:		
Delivery rate at 0 bar	l/min	8 ... 23
Pressure at 0 liters	bar	0.1 ... 0.6
Max. viscosity	cSt	50
Dimensions (WxDxH)	cm	13.2 x 16.0 x 35.5
Useful immersion depth	cm	16.0
Weight	kg	2.5
Ambient temperature range	°C	5 ... 40
Mains power connection 100 V/50 Hz/60 Hz	V/Hz	100 ±10 % / 50 / 60
Power consumption	A	10
Mains power connection 115 V/50 Hz/60 Hz	V/Hz	115 ±10 % / 50 / 60
Power consumption	A	11
Mains power connection 200 V/50 Hz/60 Hz	V/Hz	200 ±10 % / 50 / 60
Power consumption	A	9
Mains power connection 230 V/50 Hz/60 Hz	V/Hz	230 ±10 % / 50 / 60
Power consumption (at 230 V)	A	10
Classification, according to DIN 12876-1		III (FL)

17.2 Technical data for refrigeration circulation circulator

CORIO refrigeration circulator		DYNEO DD-200F				DYNEO DD-201F	
Working temperature range	°C	-20 ... 200				-20 ... 200	
Temperature stability	°C	±0.01					
Temperature display		TFT					
Setting/Display resolution	°C	0.01					
ATC – Absolute Temperature		3-point					
Temperature control		PID3					
Refrigeration capacity	°C	+200	+20	+10	0	-10	-20
(Medium ethanol)	kW	0,2	0,2	0,17	0,15	0,1	0,02
Refrigerant		R134a					
Overall dimensions (HxDxH)	cm	23 x 39 x 65				44 x 41 x 44	
Useful bath opening (WxD)	cm	13 x 15				13 x 15	
Bath depth	cm	15				15	
Filling volume, from...to	Liters	3.0 ... 4.0				3.0 ... 4.0	
Weight, with circulator	kg	25.7				24.7	
Ambient temperature range	°C	5 ... 40					
Mains connection	V / Hz	100 ± 10 % / 50 / 60					
Power consumption (at 100 V)	A	Nom. 4 / Tot. 15					
Mains connection	V / Hz	115 ±10% / 60					
Power consumption (at 115 V)	A	Nom. 4 / Tot. 12				Nom. 3 / Tot. 12	
Mains connection	V / Hz	230 ±10% / 50 / 60					
Power consumption (at 230 V)	A	Nom. 2 / Tot. 16					
For CH model (at 230 V)	A	Nom. 2 / Tot. 10					
For GB model (at 230 V)	A	Nom. 2 / Tot. 13					

Refrigeration circulator		DYNEO DD-300F					
Working temperature range	°C	-30 ... 200					
Temperature stability	°C	±0.01					
Temperature display		TFT					
Resolution	°C	0.01					
ATC – Absolute Temperature Calibration		3-point					
Temperature control		PID3					
Refrigeration capacity (ethanol)	°C	+200	+20	+10	0	-10	+20
	kW	0.30	0.30	0.30	0.27	0.19	0.08
Refrigerant		R134a					
Dimensions (WxDxH)	cm	24 x 42 x 66					
Useful bath opening (WxD)	cm	13 x 15					
Bath depth	cm	15					
Filling volume, from ... to	Liters	3.0 ... 4.0					
Weight, with circulator	kg	27.7					
Ambient temperature range	°C	5 ... 40					
Mains connection	V/Hz	100 ±10% /50-60					
Power consumption	A	Nom. 5 / Tot. 15					
Mains connection	V/Hz	115 ±10% / 60					
Power consumption	A	Nom. 4 / Tot. 12					
Mains connection	V/Hz	200-230 ±10 %/50 / 60					
Power consumption	A	Nom. 2 / Tot. 16					
For CH model	A	Nom. 2 / Tot. 10					
For GB model	A	Nom. 2 / Tot. 13					
Mains connection	V/Hz	208-230 ±10 % / 60					
Power consumption	A	Nom. 2 / Tot. 16					

Refrigeration circulator		DYNEO DD-600F					
Working temperature range	°C	-35 ... 200					
Temperature stability	°C	±0.01					
Temperature display		TFT					
Resolution	°C	0,01					
ATC – Absolute Temperature Calibration		3-point					
Temperature control		PID3					
Refrigeration capacity (ethanol)	°C	+20	+10	0	-10	-20	-30
R452A*	kW	0.60	0.54	0.50	0.33	0.19	0.07
R449A		0.60	0.54	0.44	0.27	0.16	0.04
Refrigerant		R452A*, R449A					
Dimensions (WxDxH)	cm	33 x 47 x 69					
Useful bath opening (WxD)	cm	22 x 15					
Bath depth	cm	15					
Filling volume, from ... to	Liters	5,0 ... 7,5					
Weight, with circulator	kg	35,7					
Ambient temperature range	°C	5 ... 40					
Mains connection	V/Hz	100 ±10 % / 50 / 60					
Power consumption	A	Nom. 11 / Tot. 15					
Mains connection	V/Hz	115 ±10 % / 60					
Power consumption	A	Nom. 7 / Tot. 12					
Mains connection	V/Hz	200-230 ±10 %/50/60					
Power consumption	A	Nom. 3-4 / Tot. 16					
For CH model	A	Nom. 3-4 / Tot. 10					
For GB model	A	Nom. 3-4 / Tot. 13					

* at 100 V/50-60 Hz

Refrigeration circulator		DYNEO DD-601F					
Working temperature range	°C	-35 ... 200					
Temperature stability	°C	±0,01					
Temperature display		TFT					
Resolution	°C	0,01					
ATC – Absolute Temperature Calibration		3-point					
Temperature control		PID3					
Refrigeration capacity (ethanol)	°C	+20	+10	0	-10	-20	-30
R452A*	kW	0.60	0.54	0.50	0.33	0.19	0.07
R449A		0.60	0.54	0.44	0.27	0.16	0.04
Refrigerant		R452A*, R449A					
Dimensions (WxDxH)	cm	36 x 46 x 74					
Useful bath opening (WxD)	cm	22,0 x 15,0					
Bath depth	cm	20,0					
Filling volume, from ... to	Liters	8,0 ... 10,0					
Weight, with circulator	kg	38,2					
Ambient temperature range	°C	5 ... 40					
Mains connection	V/Hz	100 ±10 % 50 / 60					
Power consumption	A	Nom. 11 / Tot. 15					
Mains connection	V/Hz	115 ±10 % / 60					
Power consumption	A	Nom. 7 / Tot. 12					
Mains connection	V/Hz	200-230 ±10 %/50/60					
Power consumption	A	Nom. 3-4 / Tot. 16					
For CH model	A	Nom. 3-4 / Tot. 10					
For GB model	A	100 ±10 % 50 / 60					

* at 100 V/50-60 Hz

Refrigeration circulator		DYNEO DD-900F					
Working temperature range	°C	-38 ... 200					
Temperature stability	°C	±0.01					
Temperature display		TFT					
Resolution	°C	0.01					
ATC – Absolute Temperat. Calibration		3-point					
Temperature control		PID3					
Refrigeration capacity (Medium ethanol)	°C	+20	+10	0	-10	-20	-30
	kW	0.90	0.85	0.80	0.52	0.31	0.11
Refrigerant		R449A					
Dimensions (WxDxH)	cm	39 x 62 x 75					
Useful bath opening (WxD)	cm	26,0 x 35,0					
Bath depth	cm	20,0					
Filling volume, from...to	Liter	21,0 ... 30,0					
Weight, with circulator	kg	52,0					
Ambient temperature range	°C	5 ... 40					
Mains connection	V/Hz	115 ±10 % / 60					
Power consumption	A	Nom. 8 / Tot. 16					
Mains connection	V/Hz	200-230 ±10 %/50/60					
Power consumption	A	Nom. 5 / Tot. 16					
For CH model	A	Nom. 5 / Tot. 10					
For GB model	A	Nom. 5 / Tot. 13					

Refrigeration circulator		DYNEO DD-1000F					
Working temperature range	°C	-50 ... 200					
Temperature stability	°C	±0.01					
Temperature display		TFT					
Resolution	°C	0.01					
ATC – Absolute Temperat. Calibration		3-point					
Temperature control		PID3					
Refrigeration capacity (Medium ethanol)	°C	20	0	-10	-20	-30	-40
	kW	1.00	0.96	0.73	0.51	0.25	0.11
Refrigerant		R449A					
Dimensions (WxDxH)	cm	42 x 49 x 70					
Useful bath opening (WxD)	cm	18.0 x 13.0					
Bath depth	cm	15.0					
Filling volume, from ... to	Liter	5.0 ... 7.5					
Weight, with circulator	kg	36.0					
Ambient temperature range	°C	5 ... 40					
Mains connection	V/Hz	115 ±10 % / 60					
Power consumption	A	Nom. 7 / Tot. 12					
Mains connection	V/Hz	200-230 -10 %; +5 %/50/60					
Power consumption	A	Nom. 3-4 / Tot. 16					
For CH model	A	Nom. 4 / Tot. 10					
For GB model		Nom. 3-4 / Tot. 13					
Mains connection	V/Hz	230 -10 %; +5 %/60					
Power consumption	A	Nom. 4 / Tot. 16					

Refrigeration circulator		DYNEO DD-1001F					
Working temperature range	°C	-38 ... 100					
Temperature stability	°C	±0.01					
Temperature display		TFT					
Resolution	°C	0.01					
ATC – Absolute Temperat. Calibration		3-point					
Temperature control		PID3					
Refrigeration capacity (Medium ethanol)	°C	20	10	0	-10	-20	-30
	kW	1.00	0.95	0.85	0.60	0.32	0.12
Refrigerant		R449A					
Dimensions (WxDxH)	cm	45 x 64 x 77					
Useful bath opening (WxD)	cm	35.0 x 41.0					
Bath depth	cm	30.0					
Filling volume, from ... to	Liter	42 ... 56					
Weight, with circulator	kg	68,0					
Ambient temperature range	°C	5 ... 40					
Mains connection	V/Hz	200-230 ±5 %/50/60					
Power consumption (at 230 V)	A	Nom. 5 / Tot. 16					
For CH model (at 230 V)	A	Nom. 5 / Tot. 10					
For GB model (at 230 V)	A	Nom. 5 / Tot. 13					

All measurements have been carried out at: rated voltage and frequency. Ambient temperature: 20 °C. Technical changes without prior notification reserved.

Safety precautions to IEC 61010-2-010:
 Excess temperature protection, adjustable 0°C ... 220°C
 Low level protection Float switch
 Classification to DIN 12876-1 Class III
 Alarm Optical and audible (permanent)

Ambient conditions to IEC 61010-1:

- For indoor use only.
- Altitude up to 200 m - normal zero.
- Ambient temperature: +5 ... +40 °C
- EMC requirements
- The device is an ISM device of group 1 per CISPR 11 (uses HF for internal purposes) and is classified in class A (industrial and commercial sector).

NOTICE

- Devices of class A are intended for the use in an industrial electromagnetic environment.
- When operating in other electromagnetic environments, their electromagnetic compatibility may be impacted.
- This device is not intended for the use in living areas and cannot guarantee adequate protection of the radio reception in such environments.

Humidity

- Maximum relative humidity 80%, for temperatures up to 31°C,
- Linear decrease to 50% relative humidity at a temperature of 40°C
- Max. voltage fluctuation of ±10% are permissible.

Protection class to EN 60 529:	IP 21
The device complies with	Safety class I
Overvoltage category	II
Pollution degree	2

17.3 Refrigerant

In the event of an error in the refrigeration system (leak) a certain room size is specified in standard EN 378 for each kg of refrigerant.

The refrigerant used and the quantity are stated on the type plate.

Refrigerant used in relation to JULABO	Limit value for 1 m ³ volume [kg]
R134a	0.25
R449A	0.357
R452A	0.423

Information about the used refrigerants

The **Regulation (EU) No. 517/2014 on fluorinated greenhouse gases** applies to all systems which contain fluorinated refrigerants and replaces (EC) 842/2006.

The aim of the Regulation is to protect the environment by reducing emissions of fluorinated greenhouse gases.

Among other things it regulates the emission limits, use and recovery of these substances. It also contains requirements for operators of systems which require / contain these substances to function.

Under Regulation 517/2014, the operator of a system of this nature has the following duties:

- The operator must ensure that the equipment is checked at regular intervals for leaks.
- These intervals depend on the CO₂ equivalent of the system. This is calculated from the refrigerant fill volume and type of refrigerant. The CO₂ equivalent of your system is shown on the model plate.
- The operator undertakes to have maintenance, repair, service, recovery and recycling work carried out by certified personnel who have been authorized by JULABO.
- All such work must be documented. The operator must keep records and archive them for at least five years. The records must be submitted to the relevant authority on request.

Refer to the text of the Regulation for further information.

18 Materials of parts in contact with the bath fluid

18.1 Circulator

Description	Material
Motor	1.4301
Motor shaft and adapter	1.4404
Pump	PPS
Heater	1.4404 / 316L
Sensor 2xPt 100 metal, fitted	1.4571
Sensor connection	1.4301
Float	1.4401
Float pipe	1.4571
Tubing	FPM / FKM

19 Accessories

A wide selection of accessories is available for the following products for optimum adaption to your temperature control task.

19.1 For external connection

- Bath fluids
- Tubing
- Shut-off valve
- Barbed fittings
- Adapters

19.2 For open baths

Temperature applications for samples, preparation of samples for serology and clinical chemistry, analysis, etc.

- Test tube racks
- Immersion-height adjustable platforms

20 Maintenance, cleaning, storage

⚠ CAUTION



Danger of injury during maintenance, repair and transport Danger from mains voltage.

- Have all service and repair work carried out by authorized specialists only.
- Switch off the unit and pull the plug,
 - before starting any cleaning work,
 - before carrying out any service or repair work or
 - before moving the unit.
- Empty the unit completely before moving it.
- Transport the unit carefully.

20.1 Maintain the refrigeration capacity.



The device is designed for continuous operation in normal conditions. No regular maintenance work is required.

The condenser on the front should be cleaned from time to time to maintain the full refrigeration capacity.

1. Switch off the device.
2. Pull the plug.
3. Let the unit cool down to room temperature.
4. Remove the ventilation grille.
5. Vacuum the dirt on the condenser.

20.2 Cleaning

Use low surface tension water (for example soap suds) to clean the bath and the functional parts of the circulator which are immersed in it. Clean the exterior device with a cloth and low surface tension water.

The circulator is designed for continuous use in normal conditions. No regular maintenance work is required.

The bath tank should only be filled with suitable bath fluid. In the event of contamination, the bath fluid must be replaced from time to time.

Cleaning open bath tanks

NOTICE

- Leaking bath tanks due to unsuitable cleaning products.
- These bath tanks are not resistant to solvents and pure alcohol. Incorrect cleaning products will make the surface of the bath go cloudy and will dissolve the adhesive. Plastic baths will therefore start to leak.

- Clean bath tanks with wet products - never rub them dry. The cloths or sponges you use should not be contaminated (with scouring particles or dust).
- A good, essentially smear-free cleaning effect can be achieved using a microfiber cloth moistened with water.
- Use warm water with a few drops of washing-up liquid and a soft cloth to clean the bath.
- If it has heavier soiling, particularly if it is greasy, benzol-free pure benzene (washing benzene, light benzene) can be used for cleaning.

20.3 Storage

Units which are not to be reused must be stored in a dry, place, protected from dust and frost, after cleaning. The system components must be fully emptied and carefully dried, for example using compressed air. Seal the connectors.

21 Repair service

If you return a unit to JULABO:

- Clean the unit to avoid any harm to the service personnel.
- It is essential that you enclose a short fault description.
- Before returning the device, please complete an online return form.
- Ensure careful and adequate packing.
- JULABO cannot accept any liability for damage caused by incorrect packaging.
- In the interest of product improvement, JULABO reserves the right to make any necessary technical modifications during the repair to ensure the proper functioning of the unit.
-

22 Warranty

JULABO warrants the proper functioning of the unit when connected and handled correctly and in accordance with the operating manual.

The warranty period is

one year.

Extension of warranty period – free of charge

2 Years Warranty
1Plus Warranty
Registration free of charge on www.julabo.com

With the '1PLUS warranty' the user receives a free of charge extension to the warranty of up to 24 months, limited to a maximum of 10 000 working hours.

To apply for this extended warranty the user must register the unit on the JULABO web site, indicating the serial no. The extended warranty will apply from the date of JULABO GmbH's original invoice.

JULABO GmbH reserves the right to decide the validity of any warranty claim. In case of faults arising either due to faulty materials or workmanship, parts will be repaired or replaced free of charge, or a new replacement unit will be supplied.

Any other compensation claims are excluded from this guarantee.

23 Waste disposal

23.1 Packaging

Packaging materials must be disposed of as prescribed by the current local regulations.

23.2 Unit



In the European Economic Area (EEA) the disposal of waste equipment is regulated in the "**Directive of the European Parliament and of the Council on Waste Electrical and Electronic Equipment (WEEE)**". The current official journal on this matter is available on the European Parliament's homepage.

The symbol for the separate collection of electrical and electronic equipment is a crossed-out trash can.

Disposal with household waste (unsorted waste) or similar collections of municipal waste is not permitted!

Contact an authorized waste disposal contractor in your country.

23.3 Refrigerant

Refrigerants must be disposed of as prescribed by the current local regulations.

They may only be disposed of by trained personnel.

24 EC conformity

EG-Konformitätserklärung nach EG Maschinenrichtlinie 2006/42/EG, Anhang II A
EC-Declaration of Conformity to EC Machinery Directive 2006/42/EC, Annex II A

Hersteller / Manufacturer:

JULABO GmbH
 Gerhard-Juchheim-Strasse 1
 77960 Seelbach / Germany
 Tel: +49(0)7823 / 51 - 0



Hiermit erklären wir, dass das nachfolgend bezeichnete Produkt
We hereby declare, that the following product

Produkt / Product: Thermostat / Circulator

Typ / Type: DYNEO DD

Serien-Nr. / Serial-No.: siehe Typenschild / see type label

aufgrund seiner Konzipierung und Bauart in der von uns in Verkehr gebrachten Ausführung den grundlegenden Sicherheits- und Gesundheitsanforderungen den nachfolgend aufgeführten EG-Richtlinien entspricht.
due to the design and construction, as assembled and marketed by our Company – complies with fundamental safety and health requirements according to the following EC-Directives.

Maschinenrichtlinie 2006/42/EG; Machinery Directive 2006/42/EC
EMV-Richtlinie 2014/30/EU; EMC-Directive 2014/30/EU
RoHS-Richtlinie 2011/65/EU; RoHS-Directive 2011/65/EU

Angewandte harmonisierte Normen und techn. Spezifikationen:
The above-named product is in compliance with the following harmonized standards and technical specifications:

- EN 50581 : 2012
Technische Dokumentation zur Beurteilung von Elektro- und Elektronikgeräten hinsichtlich der Beschränkung gefährlicher Stoffe
 Technical documentation for the assessment of electrical and electronic products with respect to the restriction of hazardous substances
- EN ISO 12100 : 2010
Sicherheit von Maschinen - Allgemeine Gestaltungsgrundsätze - Risikoanalyse und Risikominderung (ISO 12100:2010)
 Safety of machinery - General principles for design - Risk assessment and risk reduction (ISO 12100:2010)
- EN 61010-1 : 2010
Sicherheitsbestimmungen für elektrische Mess-, Steuer-, Regel- und Laborgeräte, Teil 1: Allgemeine Anforderungen
 Safety requirements for electrical equipment for measurement, control, and laboratory use, Part 1: General requirements
- EN 61010-2-010 : 2014
Sicherheitsbestimmungen für elektrische Mess-, Steuer-, Regel- und Laborgeräte, Teil 2-010: Besondere Anforderungen an Laborgeräte für das Erhitzen von Stoffen
 Safety requirements for electrical equipment for measurement, control, and laboratory use, Part 2-010: Particular requirements for laboratory equipment for the heating of materials
- EN 61326-1 : 2013
Elektrische Mess-, Steuer-, Regel- und Laborgeräte- EMV-Anforderungen- Teil 1: Allgemeine Anforderungen
 Electrical equipment for measurement, control, and laboratory use - EMC requirements - Part 1: General requirements

Bevollmächtigter für die Zusammenstellung der techn. Unterlagen:
Authorized representative in charge of administering technical documentation:
 Hr. Torsten Kauschke, im Hause / on the manufacturer's premises as defined above

Die Konformitätserklärung wurde ausgestellt
The declaration of conformity was issued and valid of

Seelbach, 21.03.2018



 M. Juchheim, Geschäftsführer / Managing Director

2017_163_DYNEO_DD_Thermostat_d_e.docx

EG-Konformitätserklärung nach EG Maschinenrichtlinie 2006/42/EG, Anhang II A
EC-Declaration of Conformity to EC Machinery Directive 2006/42/EC, Annex II A

Hersteller / Manufacturer:

JULABO GmbH
 Gerhard-Juchheim-Strasse 1
 77960 Seelbach / Germany
 Tel: +49(0)7823 / 51 - 0



Hiermit erklären wir, dass das nachfolgend bezeichnete Produkt
We hereby declare, that the following product

Produkt / Product: Kältegerät / Refrigeration Unit

Typ / Type: 200F

Serien-Nr. / Serial-No.: siehe Typenschild / see type label

aufgrund seiner Konzipierung und Bauart in der von uns in Verkehr gebrachten Ausführung den grundlegenden Sicherheits- und Gesundheitsanforderungen den nachfolgend aufgeführten EG-Richtlinien entspricht.
due to the design and construction, as assembled and marketed by our Company – complies with fundamental safety and health requirements according to the following EC-Directives.

Maschinenrichtlinie 2006/42/EG; Machinery Directive 2006/42/EC
EMV-Richtlinie 2014/30/EU; EMC-Directive 2014/30/EU
RoHS-Richtlinie 2011/65/EU; RoHS-Directive 2011/65/EU

Angewandte harmonisierte Normen und techn. Spezifikationen:

The above-named product is in compliance with the following harmonized standards and technical specifications:

EN 50581 : 2012

Technische Dokumentation zur Beurteilung von Elektro- und Elektronikgeräten hinsichtlich der Beschränkung gefährlicher Stoffe
Technical documentation for the assessment of electrical and electronic products with respect to the restriction of hazardous substances

EN ISO 12100 : 2010

Sicherheit von Maschinen - Allgemeine Gestaltungsgrundsätze - Risikobeurteilung und Risikominderung (ISO 12100:2010)
Safety of machinery - General principles for design - Risk assessment and risk reduction (ISO 12100:2010)

EN 61010-1 : 2010

Sicherheitsbestimmungen für elektrische Mess-, Steuer-, Regel- und Laborgeräte, Teil 1: Allgemeine Anforderungen
Safety requirements for electrical equipment for measurement, control, and laboratory use, Part 1: General requirements

EN 61010-2-010 : 2014

Sicherheitsbestimmungen für elektrische Mess-, Steuer-, Regel- und Laborgeräte, Teil 2-010: Besondere Anforderungen an Laborgeräte für das Erhitzen von Stoffen
Safety requirements for electrical equipment for measurement, control, and laboratory use, Part 2-010: Particular requirements for laboratory equipment for the heating of materials

EN 61326-1 : 2013

Elektrische Mess-, Steuer-, Regel- und Laborgeräte- EMV-Anforderungen- Teil 1: Allgemeine Anforderungen
Electrical equipment for measurement, control, and laboratory use - EMC requirements - Part 1: General requirements

EN 378-1 : 2016

Kälteanlagen und Wärmepumpen – Sicherheitstechnische und umweltrelevante Anforderungen – Teil 1: Grundlegende Anforderungen, Begriffe, Klassifikationen und Auswahlkriterien
Refrigerating systems and heat pumps - Safety and environmental requirements - Part 1: Basics requirements, definitions, classification and selection criteria

EN 378-2 : 2016

Kälteanlagen und Wärmepumpen – Sicherheitstechnische und umweltrelevante Anforderungen – Teil 2: Konstruktion, Herstellung, Prüfung, Kennzeichnung und Dokumentation
Refrigerating systems and heat pumps - Safety and environmental requirements - Part 2: Design, construction, testing, marking and documentation

EN 378-3 : 2016

Kälteanlagen und Wärmepumpen – Sicherheitstechnische und umweltrelevante Anforderungen – Teil 3: Aufstellungsort und Schutz von Personen
Refrigerating systems and heat pumps - Safety and environmental requirements - Part 3: Installation site and personal protection

EN 378-4 : 2016

Kälteanlagen und Wärmepumpen – Sicherheitstechnische und umweltrelevante Anforderungen – Teil 4: Betrieb, Instandhaltung, Instandsetzung und Rückgewinnung
Refrigerating systems and heat pumps - Safety and environmental requirements - Part 4: Operation, maintenance, repair and recovery

Bevollmächtigter für die Zusammenstellung der techn. Unterlagen:

Authorized representative in charge of administering technical documentation:

Hr. Torsten Kauschke, im Hause / on the manufacturer's premises as defined above

Die Konformitätserklärung wurde ausgestellt

The declaration of conformity was issued and valid of

Seelbach, 23.10.2017

 M. Juchheim, Geschäftsführer / Managing Director

2017_146_200F-Kältegerät_d_e.docx

EG-Konformitätserklärung nach EG Maschinenrichtlinie 2006/42/EG, Anhang II A
EC-Declaration of Conformity to EC Machinery Directive 2006/42/EC, Annex II A

Hersteller / Manufacturer:

JULABO GmbH
 Gerhard-Juchheim-Strasse 1
 77960 Seelbach / Germany
 Tel: +49(0)7823 / 51 - 0



Hiermit erklären wir, dass das nachfolgend bezeichnete Produkt
We hereby declare, that the following product

Produkt / Product: Kältegerät / Refrigeration Unit

Typ / Type: 201F

Serien-Nr. / Serial-No.: siehe Typenschild / see type label

aufgrund seiner Konzipierung und Bauart in der von uns in Verkehr gebrachten Ausführung den grundlegenden Sicherheits- und Gesundheitsanforderungen den nachfolgend aufgeführten EG-Richtlinien entspricht.
due to the design and construction, as assembled and marketed by our Company – complies with fundamental safety and health requirements according to the following EC-Directives.

Maschinenrichtlinie 2006/42/EG; Machinery Directive 2006/42/EC
EMV-Richtlinie 2014/30/EU; EMC-Directive 2014/30/EU
RoHS-Richtlinie 2011/65/EU; RoHS-Directive 2011/65/EU

Angewandte harmonisierte Normen und techn. Spezifikationen:

The above-named product is in compliance with the following harmonized standards and technical specifications:

EN 50581 : 2012

Technische Dokumentation zur Beurteilung von Elektro- und Elektronikgeräten hinsichtlich der Beschränkung gefährlicher Stoffe
Technical documentation for the assessment of electrical and electronic products with respect to the restriction of hazardous substances

EN ISO 12100 : 2010

Sicherheit von Maschinen - Allgemeine Gestaltungsgrundsätze - Risikobeurteilung und Risikominderung (ISO 12100:2010)
Safety of machinery - General principles for design - Risk assessment and risk reduction (ISO 12100:2010)

EN 61010-1 : 2010

Sicherheitsbestimmungen für elektrische Mess-, Steuer-, Regel- und Laborgeräte, Teil 1: Allgemeine Anforderungen
Safety requirements for electrical equipment for measurement, control, and laboratory use, Part 1: General requirements

EN 61010-2-010 : 2014

Sicherheitsbestimmungen für elektrische Mess-, Steuer-, Regel- und Laborgeräte, Teil 2-010: Besondere Anforderungen an Laborgeräte für das Erhitzen von Stoffen
Safety requirements for electrical equipment for measurement, control, and laboratory use, Part 2-010: Particular requirements for laboratory equipment for the heating of materials

EN 61326-1 : 2013

Elektrische Mess-, Steuer-, Regel- und Laborgeräte- EMV-Anforderungen- Teil 1: Allgemeine Anforderungen
Electrical equipment for measurement, control, and laboratory use - EMC requirements - Part 1: General requirements

EN 378-1 : 2016

Kälteanlagen und Wärmepumpen – Sicherheitstechnische und umweltrelevante Anforderungen – Teil 1: Grundlegende Anforderungen, Begriffe, Klassifikationen und Auswahlkriterien
Refrigerating systems and heat pumps - Safety and environmental requirements - Part 1: Basics requirements, definitions, classification and selection criteria

EN 378-2 : 2016

Kälteanlagen und Wärmepumpen – Sicherheitstechnische und umweltrelevante Anforderungen – Teil 2: Konstruktion, Herstellung, Prüfung, Kennzeichnung und Dokumentation
Refrigerating systems and heat pumps - Safety and environmental requirements - Part 2: Design, construction, testing, marking and documentation

EN 378-3 : 2016

Kälteanlagen und Wärmepumpen – Sicherheitstechnische und umweltrelevante Anforderungen – Teil 3: Aufstellungsort und Schutz von Personen
Refrigerating systems and heat pumps - Safety and environmental requirements - Part 3: Installation site and personal protection

EN 378-4 : 2016

Kälteanlagen und Wärmepumpen – Sicherheitstechnische und umweltrelevante Anforderungen – Teil 4: Betrieb, Instandhaltung, Instandsetzung und Rückgewinnung
Refrigerating systems and heat pumps - Safety and environmental requirements - Part 4: Operation, maintenance, repair and recovery

Bevollmächtigter für die Zusammenstellung der techn. Unterlagen:

Authorized representative in charge of administering technical documentation:

Hr. Torsten Kauschke, im Hause / on the manufacturer's premises as defined above

Die Konformitätserklärung wurde ausgestellt

The declaration of conformity was issued and valid of

Seelbach, 23.10.2017

M. Juchheim, Geschäftsführer / Managing Director

2017_147_201F-Kältegerät_d_e.docx

EG-Konformitätserklärung nach EG Maschinenrichtlinie 2006/42/EG, Anhang II A
EC-Declaration of Conformity to EC Machinery Directive 2006/42/EC, Annex II A

Hersteller / Manufacturer:

JULABO GmbH
 Gerhard-Juchheim-Strasse 1
 77960 Seelbach / Germany
 Tel: +49(0)7823 / 51 - 0



Hiermit erklären wir, dass das nachfolgend bezeichnete Produkt
We hereby declare, that the following product

Produkt / Product: Kältegerät / Refrigeration Unit

Typ / Type: 300F

Serien-Nr. / Serial-No.: siehe Typenschild / see type label

aufgrund seiner Konzipierung und Bauart in der von uns in Verkehr gebrachten Ausführung den grundlegenden Sicherheits- und Gesundheitsanforderungen den nachfolgend aufgeführten EG-Richtlinien entspricht.
due to the design and construction, as assembled and marketed by our Company – complies with fundamental safety and health requirements according to the following EC-Directives.

Maschinenrichtlinie 2006/42/EG; Machinery Directive 2006/42/EC
EMV-Richtlinie 2014/30/EU; EMC-Directive 2014/30/EU
RoHS-Richtlinie 2011/65/EU; RoHS-Directive 2011/65/EU

Angewandte harmonisierte Normen und techn. Spezifikationen:

The above-named product is in compliance with the following harmonized standards and technical specifications:

EN 50581 : 2012

Technische Dokumentation zur Beurteilung von Elektro- und Elektronikgeräten hinsichtlich der Beschränkung gefährlicher Stoffe
Technical documentation for the assessment of electrical and electronic products with respect to the restriction of hazardous substances

EN ISO 12100 : 2010

Sicherheit von Maschinen - Allgemeine Gestaltungsgrundsätze - Risikobeurteilung und Risikominderung (ISO 12100:2010)
Safety of machinery - General principles for design - Risk assessment and risk reduction (ISO 12100:2010)

EN 61010-1 : 2010

Sicherheitsbestimmungen für elektrische Mess-, Steuer-, Regel- und Laborgeräte, Teil 1: Allgemeine Anforderungen
Safety requirements for electrical equipment for measurement, control, and laboratory use. Part 1: General requirements

EN 61010-2-010 : 2014

Sicherheitsbestimmungen für elektrische Mess-, Steuer-, Regel- und Laborgeräte, Teil 2-010: Besondere Anforderungen an Laborgeräte für das Erhitzen von Stoffen
Safety requirements for electrical equipment for measurement, control, and laboratory use, Part 2-010: Particular requirements for laboratory equipment for the heating of materials

EN 61326-1 : 2013

Elektrische Mess-, Steuer-, Regel- und Laborgeräte- EMV-Anforderungen- Teil 1: Allgemeine Anforderungen
Electrical equipment for measurement, control, and laboratory use - EMC requirements - Part 1: General requirements

EN 378-1 : 2016

Kälteanlagen und Wärmepumpen – Sicherheitstechnische und umweltrelevante Anforderungen – Teil 1: Grundlegende Anforderungen, Begriffe, Klassifikationen und Auswahlkriterien
Refrigerating systems and heat pumps - Safety and environmental requirements - Part 1: Basics requirements, definitions, classification and selection criteria

EN 378-2 : 2016

Kälteanlagen und Wärmepumpen – Sicherheitstechnische und umweltrelevante Anforderungen – Teil 2: Konstruktion, Herstellung, Prüfung, Kennzeichnung und Dokumentation
Refrigerating systems and heat pumps - Safety and environmental requirements - Part 2: Design, construction, testing, marking and documentation

EN 378-3 : 2016

Kälteanlagen und Wärmepumpen – Sicherheitstechnische und umweltrelevante Anforderungen – Teil 3: Aufstellungsort und Schutz von Personen
Refrigerating systems and heat pumps - Safety and environmental requirements - Part 3: Installation site and personal protection

EN 378-4 : 2016

Kälteanlagen und Wärmepumpen – Sicherheitstechnische und umweltrelevante Anforderungen – Teil 4: Betrieb, Instandhaltung, Instandsetzung und Rückgewinnung
Refrigerating systems and heat pumps - Safety and environmental requirements - Part 4: Operation, maintenance, repair and recovery

Bevollmächtigter für die Zusammenstellung der techn. Unterlagen:

Authorized representative in charge of administering technical documentation:

Hr. Torsten Kauschke, im Hause / on the manufacturer's premises as defined above

Die Konformitätserklärung wurde ausgestellt

The declaration of conformity was issued and valid of

Seelbach, 23.10.2017

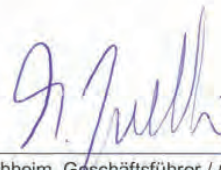

M. Juchheim, Geschäftsführer / Managing Director

2017_148_300F-Kältegerät_d_e.docx

EG-Konformitätserklärung nach EG Maschinenrichtlinie 2006/42/EG, Anhang II A EC-Declaration of Conformity to EC Machinery Directive 2006/42/EC, Annex II A

Hersteller / Manufacturer:

JULABO GmbH
Gerhard-Juchheim-Strasse 1
77960 Seelbach / Germany
Tel: +49(0)7823 / 51 - 0



Hiermit erklären wir, dass das nachfolgend bezeichnete Produkt
We hereby declare, that the following product

Produkt / Product: Kältegerät / Refrigeration Unit

Typ / Type: 600F

Serien-Nr. / Serial-No.: siehe Typenschild / see type label

aufgrund seiner Konzipierung und Bauart in der von uns in Verkehr gebrachten Ausführung den grundlegenden Sicherheits- und Gesundheitsanforderungen den nachfolgend aufgeführten EG-Richtlinien entspricht.
due to the design and construction, as assembled and marketed by our Company – complies with fundamental safety and health requirements according to the following EC-Directives.

Maschinenrichtlinie 2006/42/EG; Machinery Directive 2006/42/EC
EMV-Richtlinie 2014/30/EU; EMC-Directive 2014/30/EU
RoHS-Richtlinie 2011/65/EU; RoHS-Directive 2011/65/EU

Angewandte harmonisierte Normen und techn. Spezifikationen:

The above-named product is in compliance with the following harmonized standards and technical specifications:

EN 50581 : 2012

Technische Dokumentation zur Beurteilung von Elektro- und Elektronikgeräten hinsichtlich der Beschränkung gefährlicher Stoffe
Technical documentation for the assessment of electrical and electronic products with respect to the restriction of hazardous substances

EN ISO 12100 : 2010

Sicherheit von Maschinen - Allgemeine Gestaltungsleitsätze - Risikobeurteilung und Risikominderung (ISO 12100:2010)
Safety of machinery - General principles for design - Risk assessment and risk reduction (ISO 12100:2010)

EN 61010-1 : 2010

Sicherheitsbestimmungen für elektrische Mess-, Steuer-, Regel- und Laborgeräte, Teil 1: Allgemeine Anforderungen
Safety requirements for electrical equipment for measurement, control, and laboratory use, Part 1: General requirements

EN 61010-2-010 : 2014

Sicherheitsbestimmungen für elektrische Mess-, Steuer-, Regel- und Laborgeräte, Teil 2-010: Besondere Anforderungen an Laborgeräte für das Erhitzen von Stoffen
Safety requirements for electrical equipment for measurement, control, and laboratory use, Part 2-010: Particular requirements for laboratory equipment for the heating of materials

EN 61326-1 : 2013

Elektrische Mess-, Steuer-, Regel- und Laborgeräte-EMV-Anforderungen- Teil 1: Allgemeine Anforderungen
Electrical equipment for measurement, control, and laboratory use - EMC requirements - Part 1: General requirements

EN 378-1 : 2016

Kälteanlagen und Wärmepumpen – Sicherheitstechnische und umweltrelevante Anforderungen – Teil 1: Grundlegende Anforderungen, Begriffe, Klassifikationen und Auswahlkriterien
Refrigerating systems and heat pumps - Safety and environmental requirements - Part 1: Basics requirements, definitions, classification and selection criteria

EN 378-2 : 2016

Kälteanlagen und Wärmepumpen – Sicherheitstechnische und umweltrelevante Anforderungen – Teil 2: Konstruktion, Herstellung, Prüfung, Kennzeichnung und Dokumentation
Refrigerating systems and heat pumps - Safety and environmental requirements - Part 2: Design, construction, testing, marking and documentation

EN 378-3 : 2016

Kälteanlagen und Wärmepumpen – Sicherheitstechnische und umweltrelevante Anforderungen – Teil 3: Aufstellungsort und Schutz von Personen
Refrigerating systems and heat pumps - Safety and environmental requirements - Part 3: Installation site and personal protection

EN 378-4 : 2016

Kälteanlagen und Wärmepumpen – Sicherheitstechnische und umweltrelevante Anforderungen – Teil 4: Betrieb, Instandhaltung, Instandsetzung und Rückgewinnung
Refrigerating systems and heat pumps - Safety and environmental requirements - Part 4: Operation, maintenance, repair and recovery

Bevollmächtigter für die Zusammenstellung der techn. Unterlagen:

Authorized representative in charge of administering technical documentation:

Hr. Torsten Kauschke, im Hause / on the manufacturer's premises as defined above

Die Konformitätserklärung wurde ausgestellt

The declaration of conformity was issued and valid of

Seelbach, 23.10.2017

M. Juchheim, Geschäftsführer / Managing Director

2017_149_600F-Kältegerät_d_e.docx

EG-Konformitätserklärung nach EG Maschinenrichtlinie 2006/42/EG, Anhang II A
EC-Declaration of Conformity to EC Machinery Directive 2006/42/EC, Annex II A

Hersteller / Manufacturer:

JULABO GmbH
 Gerhard-Juchheim-Strasse 1
 77960 Seelbach / Germany
 Tel: +49(0)7823 / 51 - 0



Hiermit erklären wir, dass das nachfolgend bezeichnete Produkt
We hereby declare, that the following product

Produkt / Product: Kältegerät / Refrigeration Unit

Typ / Type: 601F

Serien-Nr. / Serial-No.: siehe Typenschild / see type label

aufgrund seiner Konzipierung und Bauart in der von uns in Verkehr gebrachten Ausführung den grundlegenden Sicherheits- und Gesundheitsanforderungen den nachfolgend aufgeführten EG-Richtlinien entspricht.
due to the design and construction, as assembled and marketed by our Company – complies with fundamental safety and health requirements according to the following EC-Directives.

Maschinenrichtlinie 2006/42/EG; Machinery Directive 2006/42/EC
EMV-Richtlinie 2014/30/EU; EMC-Directive 2014/30/EU
RoHS-Richtlinie 2011/65/EU; RoHS-Directive 2011/65/EU

Angewandte harmonisierte Normen und techn. Spezifikationen:

The above-named product is in compliance with the following harmonized standards and technical specifications:

EN 50581 : 2012

Technische Dokumentation zur Beurteilung von Elektro- und Elektronikgeräten hinsichtlich der Beschränkung gefährlicher Stoffe
Technical documentation for the assessment of electrical and electronic products with respect to the restriction of hazardous substances

EN ISO 12100 : 2010

Sicherheit von Maschinen - Allgemeine Gestaltungsleitsätze - Risikobeurteilung und Risikominderung (ISO 12100:2010)
Safety of machinery - General principles for design - Risk assessment and risk reduction (ISO 12100:2010)

EN 61010-1 : 2010

Sicherheitsbestimmungen für elektrische Mess-, Steuer-, Regel- und Laborgeräte, Teil 1: Allgemeine Anforderungen
Safety requirements for electrical equipment for measurement, control, and laboratory use, Part 1: General requirements

EN 61010-2-010 : 2014

Sicherheitsbestimmungen für elektrische Mess-, Steuer-, Regel- und Laborgeräte, Teil 2-010: Besondere Anforderungen an Laborgeräte für das Erhitzen von Stoffen
Safety requirements for electrical equipment for measurement, control, and laboratory use, Part 2-010: Particular requirements for laboratory equipment for the heating of materials

EN 61326-1 : 2013

Elektrische Mess-, Steuer-, Regel- und Laborgeräte- EMV-Anforderungen- Teil 1: Allgemeine Anforderungen
Electrical equipment for measurement, control, and laboratory use - EMC requirements - Part 1: General requirements

EN 378-1 : 2016

Kälteanlagen und Wärmepumpen – Sicherheitstechnische und umweltrelevante Anforderungen – Teil 1: Grundlegende Anforderungen, Begriffe, Klassifikationen und Auswahlkriterien
Refrigerating systems and heat pumps - Safety and environmental requirements - Part 1: Basics requirements, definitions, classification and selection criteria

EN 378-2 : 2016

Kälteanlagen und Wärmepumpen – Sicherheitstechnische und umweltrelevante Anforderungen – Teil 2: Konstruktion, Herstellung, Prüfung, Kennzeichnung und Dokumentation
Refrigerating systems and heat pumps - Safety and environmental requirements - Part 2: Design, construction, testing, marking and documentation

EN 378-3 : 2016

Kälteanlagen und Wärmepumpen – Sicherheitstechnische und umweltrelevante Anforderungen – Teil 3: Aufstellungsort und Schutz von Personen
Refrigerating systems and heat pumps - Safety and environmental requirements - Part 3: Installation site and personal protection

EN 378-4 : 2016

Kälteanlagen und Wärmepumpen – Sicherheitstechnische und umweltrelevante Anforderungen – Teil 4: Betrieb, Instandhaltung, Instandsetzung und Rückgewinnung
Refrigerating systems and heat pumps - Safety and environmental requirements - Part 4: Operation, maintenance, repair and recovery

Bevollmächtigter für die Zusammenstellung der techn. Unterlagen:

Authorized representative in charge of administering technical documentation:

Hr. Torsten Kauschke, im Hause / on the manufacturer's premises as defined above

Die Konformitätserklärung wurde ausgestellt

The declaration of conformity was issued and valid of

Seelbach, 03.11.2017



M. Juchheim, Geschäftsführer / Managing Director

2017_153_601F-Kältegerät_d_e.docx

EG-Konformitätserklärung nach EG Maschinenrichtlinie 2006/42/EG, Anhang II A
EC-Declaration of Conformity to EC Machinery Directive 2006/42/EC, Annex II A

Hersteller / Manufacturer:

JULABO GmbH
 Gerhard-Juchheim-Strasse 1
 77960 Seelbach / Germany
 Tel: +49(0)7823 / 51 - 0



Hiermit erklären wir, dass das nachfolgend bezeichnete Produkt
We hereby declare, that the following product

Produkt / Product: Kältegerät / Refrigeration Unit

Typ / Type: 900F

Serien-Nr. / Serial-No.: siehe Typenschild / see type label

aufgrund seiner Konzipierung und Bauart in der von uns in Verkehr gebrachten Ausführung den grundlegenden Sicherheits- und Gesundheitsanforderungen den nachfolgend aufgeführten EG-Richtlinien entspricht.
due to the design and construction, as assembled and marketed by our Company – complies with fundamental safety and health requirements according to the following EC-Directives.

Maschinenrichtlinie 2006/42/EG; Machinery Directive 2006/42/EC
EMV-Richtlinie 2014/30/EU; EMC-Directive 2014/30/EU
RoHS-Richtlinie 2011/65/EU; RoHS-Directive 2011/65/EU

Angewandte harmonisierte Normen und techn. Spezifikationen:
The above-named product is in compliance with the following harmonized standards and technical specifications:

- EN 50581 : 2012
Technische Dokumentation zur Beurteilung von Elektro- und Elektronikgeräten hinsichtlich der Beschränkung gefährlicher Stoffe
 Technical documentation for the assessment of electrical and electronic products with respect to the restriction of hazardous substances
- EN ISO 12100 : 2010
Sicherheit von Maschinen - Allgemeine Gestaltungsgrundsätze - Risikoanalyse und Risikominderung (ISO 12100:2010)
 Safety of machinery - General principles for design - Risk assessment and risk reduction (ISO 12100:2010)
- EN 61010-1 : 2010
Sicherheitsbestimmungen für elektrische Mess-, Steuer-, Regel- und Laborgeräte, Teil 1: Allgemeine Anforderungen
 Safety requirements for electrical equipment for measurement, control, and laboratory use, Part 1: General requirements
- EN 61010-2-010 : 2014
Sicherheitsbestimmungen für elektrische Mess-, Steuer-, Regel- und Laborgeräte, Teil 2-010: Besondere Anforderungen an Laborgeräte für das Erhitzen von Stoffen
 Safety requirements for electrical equipment for measurement, control, and laboratory use, Part 2-010: Particular requirements for laboratory equipment for the heating of materials
- EN 61326-1 : 2013
Elektrische Mess-, Steuer-, Regel- und Laborgeräte-EMV-Anforderungen-Teil 1: Allgemeine Anforderungen
 Electrical equipment for measurement, control, and laboratory use - EMC requirements - Part 1: General requirements
- EN 378-1 : 2016
Kälteanlagen und Wärmepumpen – Sicherheitstechnische und umweltrelevante Anforderungen – Teil 1: Grundlegende Anforderungen, Begriffe, Klassifikationen und Auswahlkriterien
 Refrigerating systems and heat pumps - Safety and environmental requirements - Part 1: Basics requirements, definitions, classification and selection criteria
- EN 378-2 : 2016
Kälteanlagen und Wärmepumpen – Sicherheitstechnische und umweltrelevante Anforderungen – Teil 2: Konstruktion, Herstellung, Prüfung, Kennzeichnung und Dokumentation
 Refrigerating systems and heat pumps - Safety and environmental requirements - Part 2: Design, construction, testing, marking and documentation
- EN 378-3 : 2016
Kälteanlagen und Wärmepumpen – Sicherheitstechnische und umweltrelevante Anforderungen – Teil 3: Aufstellungsort und Schutz von Personen
 Refrigerating systems and heat pumps - Safety and environmental requirements - Part 3: Installation site and personal protection
- EN 378-4 : 2016
Kälteanlagen und Wärmepumpen – Sicherheitstechnische und umweltrelevante Anforderungen – Teil 4: Betrieb, Instandhaltung, Instandsetzung und Rückgewinnung
 Refrigerating systems and heat pumps - Safety and environmental requirements - Part 4: Operation, maintenance, repair and recovery

Bevollmächtigter für die Zusammenstellung der techn. Unterlagen:
Authorized representative in charge of administering technical documentation:
 Hr. Torsten Kauschke, im Hause / on the manufacturer's premises as defined above

Die Konformitätserklärung wurde ausgestellt
The declaration of conformity was issued and valid of

Seelbach, 03.11.2017



 M. Juchheim, Geschäftsführer / Managing Director

2017_154_900F-Kältegerät_d_e.docx

EG-Konformitätserklärung nach EG Maschinenrichtlinie 2006/42/EG, Anhang II A
EC-Declaration of Conformity to EC Machinery Directive 2006/42/EC, Annex II A

Hersteller / Manufacturer:

JULABO GmbH
 Gerhard-Juchheim-Strasse 1
 77960 Seelbach / Germany
 Tel: +49(0)7823 / 51 - 0



Hiermit erklären wir, dass das nachfolgend bezeichnete Produkt
We hereby declare, that the following product

Produkt / Product: Kältegerät / Refrigeration Unit

Typ / Type: 1000F

Serien-Nr. / Serial-No.: siehe Typenschild / see type label

aufgrund seiner Konzipierung und Bauart in der von uns in Verkehr gebrachten Ausführung den grundlegenden Sicherheits- und Gesundheitsanforderungen den nachfolgend aufgeführten EG-Richtlinien entspricht.
due to the design and construction, as assembled and marketed by our Company – complies with fundamental safety and health requirements according to the following EC-Directives.

Maschinenrichtlinie 2006/42/EG; Machinery Directive 2006/42/EC
EMV-Richtlinie 2014/30/EU; EMC-Directive 2014/30/EU
RoHS-Richtlinie 2011/65/EU; RoHS-Directive 2011/65/EU

Angewandte harmonisierte Normen und techn. Spezifikationen:

The above-named product is in compliance with the following harmonized standards and technical specifications:

EN 50581 : 2012

Technische Dokumentation zur Beurteilung von Elektro- und Elektronikgeräten hinsichtlich der Beschränkung gefährlicher Stoffe
Technical documentation for the assessment of electrical and electronic products with respect to the restriction of hazardous substances

EN ISO 12100 : 2010

Sicherheit von Maschinen - Allgemeine Gestaltungsleitsätze - Risikobeurteilung und Risikominderung (ISO 12100:2010)
Safety of machinery - General principles for design - Risk assessment and risk reduction (ISO 12100:2010)

EN 61010-1 : 2010

Sicherheitsbestimmungen für elektrische Mess-, Steuer-, Regel- und Laborgeräte, Teil 1: Allgemeine Anforderungen
Safety requirements for electrical equipment for measurement, control, and laboratory use, Part 1: General requirements

EN 61010-2-010 : 2014

Sicherheitsbestimmungen für elektrische Mess-, Steuer-, Regel- und Laborgeräte, Teil 2-010: Besondere Anforderungen an Laborgeräte für das Erhitzen von Stoffen
Safety requirements for electrical equipment for measurement, control, and laboratory use, Part 2-010: Particular requirements for laboratory equipment for the heating of materials

EN 61326-1 : 2013

Elektrische Mess-, Steuer-, Regel- und Laborgeräte- EMV-Anforderungen- Teil 1: Allgemeine Anforderungen
Electrical equipment for measurement, control, and laboratory use - EMC requirements - Part 1: General requirements

EN 378-1 : 2016

Kälteanlagen und Wärmepumpen – Sicherheitstechnische und umweltrelevante Anforderungen – Teil 1: Grundlegende Anforderungen, Begriffe, Klassifikationen und Auswahlkriterien
Refrigerating systems and heat pumps - Safety and environmental requirements - Part 1: Basics requirements, definitions, classification and selection criteria

EN 378-2 : 2016

Kälteanlagen und Wärmepumpen – Sicherheitstechnische und umweltrelevante Anforderungen – Teil 2: Konstruktion, Herstellung, Prüfung, Kennzeichnung und Dokumentation
Refrigerating systems and heat pumps - Safety and environmental requirements - Part 2: Design, construction, testing, marking and documentation

EN 378-3 : 2016

Kälteanlagen und Wärmepumpen – Sicherheitstechnische und umweltrelevante Anforderungen – Teil 3: Aufstellungsort und Schutz von Personen
Refrigerating systems and heat pumps - Safety and environmental requirements - Part 3: Installation site and personal protection

EN 378-4 : 2016

Kälteanlagen und Wärmepumpen – Sicherheitstechnische und umweltrelevante Anforderungen – Teil 4: Betrieb, Instandhaltung, Instandsetzung und Rückgewinnung
Refrigerating systems and heat pumps - Safety and environmental requirements - Part 4: Operation, maintenance, repair and recovery

Bevollmächtigter für die Zusammenstellung der techn. Unterlagen:

Authorized representative in charge of administering technical documentation:

Hr. Torsten Kauschke, im Hause / on the manufacturer's premises as defined above

0

Die Konformitätserklärung wurde ausgestellt

The declaration of conformity was issued and valid of

Seelbach, 03.11.2017

 M. Juchheim, Geschäftsführer / Managing Director

2017_155_1000F-Kältegerät_d_e.docx

EG-Konformitätserklärung nach EG Maschinenrichtlinie 2006/42/EG, Anhang II A
EC-Declaration of Conformity to EC Machinery Directive 2006/42/EC, Annex II A

Hersteller / Manufacturer:

JULABO GmbH
 Gerhard-Juchheim-Strasse 1
 77960 Seelbach / Germany
 Tel: +49(0)7823 / 51 - 0



Hiermit erklären wir, dass das nachfolgend bezeichnete Produkt
 We hereby declare, that the following product

Produkt / Product: Kältegerät / Refrigeration Unit

Typ / Type: 1001F

Serien-Nr. / Serial-No.: siehe Typenschild / see type label

aufgrund seiner Konzipierung und Bauart in der von uns in Verkehr gebrachten Ausführung den grundlegenden Sicherheits- und Gesundheitsanforderungen den nachfolgend aufgeführten EG-Richtlinien entspricht.
 due to the design and construction, as assembled and marketed by our Company – complies with fundamental safety and health requirements according to the following EC-Directives.

Maschinenrichtlinie 2006/42/EG; Machinery Directive 2006/42/EC
EMV-Richtlinie 2014/30/EU; EMC-Directive 2014/30/EU
RoHS-Richtlinie 2011/65/EU; RoHS-Directive 2011/65/EU

Angewandte harmonisierte Normen und techn. Spezifikationen:

The above-named product is in compliance with the following harmonized standards and technical specifications:

EN 50581 : 2012

Technische Dokumentation zur Beurteilung von Elektro- und Elektronikgeräten hinsichtlich der Beschränkung gefährlicher Stoffe
 Technical documentation for the assessment of electrical and electronic products with respect to the restriction of hazardous substances

EN ISO 12100 : 2010

Sicherheit von Maschinen - Allgemeine Gestaltungsgrundsätze - Risikobeurteilung und Risikominderung (ISO 12100:2010)
 Safety of machinery - General principles for design - Risk assessment and risk reduction (ISO 12100:2010)

EN 61010-1 : 2010

Sicherheitsbestimmungen für elektrische Mess-, Steuer-, Regel- und Laborgeräte. Teil 1: Allgemeine Anforderungen
 Safety requirements for electrical equipment for measurement, control, and laboratory use. Part 1: General requirements

EN 61010-2-010 : 2014

Sicherheitsbestimmungen für elektrische Mess-, Steuer-, Regel- und Laborgeräte. Teil 2-010. Besondere Anforderungen an Laborgeräte für das Erhitzen von Stoffen
 Safety requirements for electrical equipment for measurement, control, and laboratory use. Part 2-010: Particular requirements for laboratory equipment for the heating of materials

EN 61326-1 : 2013

Elektrische Mess-, Steuer-, Regel- und Laborgeräte-EMV-Anforderungen-Teil 1: Allgemeine Anforderungen
 Electrical equipment for measurement, control, and laboratory use - EMC requirements - Part 1: General requirements

EN 378-1 : 2016

Kälteanlagen und Wärmepumpen – Sicherheitstechnische und umweltrelevante Anforderungen – Teil 1: Grundlegende Anforderungen, Begriffe, Klassifikationen und Auswahlkriterien
 Refrigerating systems and heat pumps - Safety and environmental requirements - Part 1: Basics requirements, definitions, classification and selection criteria

EN 378-2 : 2016

Kälteanlagen und Wärmepumpen – Sicherheitstechnische und umweltrelevante Anforderungen – Teil 2: Konstruktion, Herstellung, Prüfung, Kennzeichnung und Dokumentation
 Refrigerating systems and heat pumps - Safety and environmental requirements - Part 2: Design, construction, testing, marking and documentation

EN 378-3 : 2016

Kälteanlagen und Wärmepumpen – Sicherheitstechnische und umweltrelevante Anforderungen – Teil 3: Aufstellungsort und Schutz von Personen
 Refrigerating systems and heat pumps - Safety and environmental requirements - Part 3: Installation site and personal protection

EN 378-4 : 2016

Kälteanlagen und Wärmepumpen – Sicherheitstechnische und umweltrelevante Anforderungen – Teil 4: Betrieb, Instandhaltung, Instandsetzung und Rückgewinnung
 Refrigerating systems and heat pumps - Safety and environmental requirements - Part 4: Operation, maintenance, repair and recovery

Bevollmächtigter für die Zusammenstellung der techn. Unterlagen:

Authorized representative in charge of administering technical documentation:
 Hr. Torsten Kauschke, im Hause / on the manufacturer's premises as defined above

Die Konformitätserklärung wurde ausgestellt
The declaration of conformity was issued and valid of

Seelbach, 03.11.2017

M. Juchheim, Geschäftsführer / Managing Director

2017_156_1001F-Kältegerät_d_e.docx