

## CO<sub>2</sub> Monitor and Datalogger

Model CO220

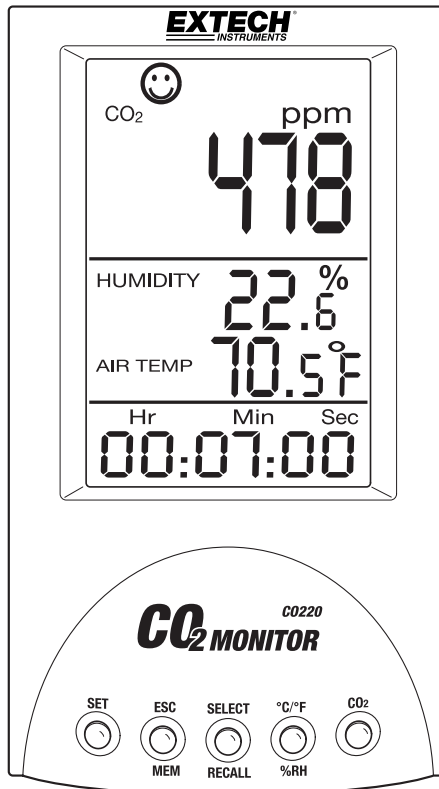

# Introduction

Congratulations on your purchase of the Model CO220 Carbon Dioxide Meter. This meter measures CO<sub>2</sub> concentration, air temperature, and relative humidity. The CO200 includes a 99 Memory Datalogger for storing and retrieving readings with date and time stamping.

The audible alarms make this is an ideal instrument for indoor air quality (IAQ) diagnostics. Carbon dioxide (CO<sub>2</sub>) is a gaseous component of the earth's atmosphere. The concentration of CO<sub>2</sub> in natural ambient air is approximately 0.04% or 400ppm.

This meter is shipped fully tested and calibrated and, with proper use, will provide years of reliable service. Please visit our website ([www.extech.com](http://www.extech.com)) to check for the latest version of this User Guide, Product Updates, and Customer Support.

## FEATURES

- Extra Large LCD simultaneously displays CO<sub>2</sub> Level, Air Temperature, & Relative Humidity
- Displayed Calendar Clock.
- Six (6) icons indicate indoor air quality levels (350 / 450 / 700 / 1000 / 1250 / 5000ppm)
- Stable NDIR sensor for CO<sub>2</sub> detection
- Automatic Baseline Calibration (ABC) function
- Audible high CO<sub>2</sub> concentration alarm with selectable high alarm threshold
- Dew Point and Wet Bulb temperature measurements

## Descriptions





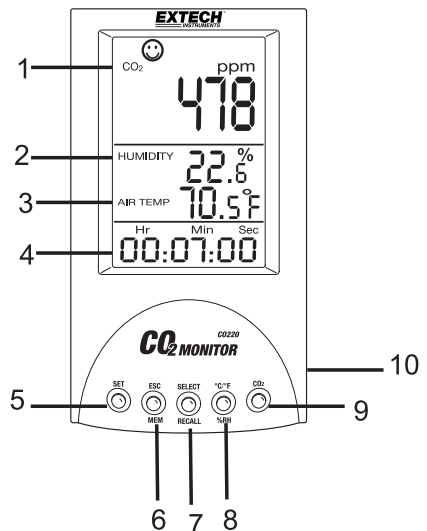

### METER

1. CO<sub>2</sub> reading
2. Relative Humidity Reading
3. Air Temperature Reading
4. Time/Date Display
5. SET button
6. ESC – MEM button
7. SELECT – RECALL button
8. C/F - %RH button
9. CO<sub>2</sub> button
10. AC adaptor jack



NOTE: CO<sub>2</sub>, Temperature and RH sensors on rear of instrument

## DISPLAY SYMBOL DESCRIPTIONS

<b>ppm</b>	CO <sub>2</sub> concentration unit of measure
	350ppm to 450ppm
	450ppm to 700ppm
	700ppm to 1000ppm
	1000ppm to 2500 ppm
	2500ppm to 5000ppm
	5000ppm and above
<b>Air Temp</b>	Air Temperature
<b>TWA</b>	Time Weighted Average (8 hrs)
<b>STEL</b>	Short-Term Exposure Limit (15 minute weighted average)
<b>IPS%</b>	Liters per second per person
<b>cfm/p</b>	Cubic feet per minute per person
<b>WB</b>	Wet Bulb temperature
<b>DP</b>	Dew Point temperature
<b>MAX/MIN</b>	Maximum or Minimum reading

## PUSH-BUTTON DESCRIPTION

<b>SET</b>	Enter setup mode Save and confirm settings
<b>ESC - MEM</b>	Exit setup and programming pages End a calibration session Memory Datalogger (99 points)
<b>SELECT/RECALL</b>	Select/Recall and Clear Datalogger Memory Readings
<b>°C/°F - %RH</b>	Temperature/Relative Humidity Modes/Temperature Unit changing
<b>CO<sub>2</sub></b>	CO <sub>2</sub> mode page stepping

## Operation

---

### POWERING THE INSTRUMENT

Power the unit by plugging the AC adaptor into the meter and into an AC source. The meter will switch ON with a short beep.

Please use an appropriate power source: 100 to 240VAC (50-60Hz). The AC adaptor's output voltage is 7.5 to 9.0V and its output current is 0.5A. Use of 3<sup>rd</sup> party AC adaptor can damage the meter.

The LCD will display the current CO<sub>2</sub> concentration, air temperature, relative humidity, date, and time (date and time toggle every 10 seconds). Six facial icons indicate the indoor air quality level and appear on the top-tier display area (see figure at right and the section titled Display Symbols earlier in this guide for additional details).

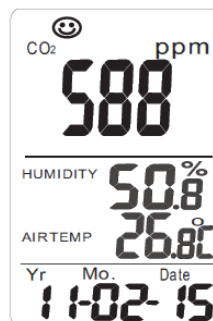

### CO<sub>2</sub> MEASUREMENT CONSIDERATIONS

The meter starts measuring when powered ON and updates readings every 6 seconds.

Response time is 10 seconds for CO<sub>2</sub> and 2 seconds for Relative Humidity.

If the environmental conditions change (for example, a low to high temperature swing) please allow 30 seconds for CO<sub>2</sub> readings and 30 minutes for Relative Humidity readings to stabilize.

NOTE: Do not hold the meter close to the mouth or any other source of CO<sub>2</sub>.

### CHANGE THE TEMPERATURE UNITS (°C/°F)

The change the displayed temperature units of measure:

1. Press and hold the SET button
2. While holding the SET button, press the °C/°F button
3. Repeat these steps to change the units again

## CO<sub>2</sub> DISPLAY PAGES

Press the CO<sub>2</sub> button to change the CO<sub>2</sub> display page on the top-tier LCD area. The pages are shown below for CO<sub>2</sub>, Max-Min, TWA, STEL, IPS% and cfm/p.

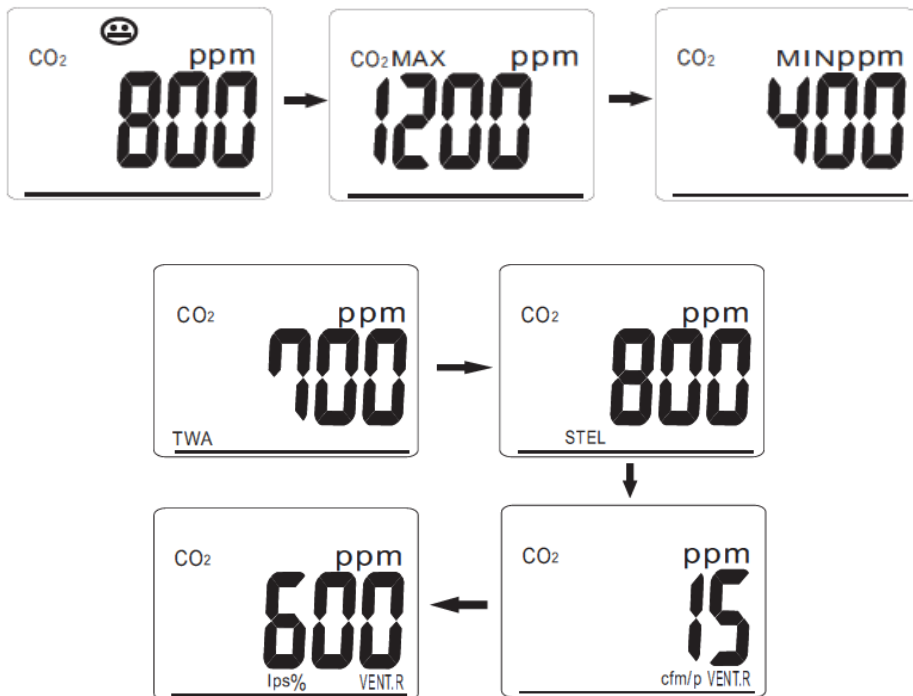

### TIME WEIGHTED AVERAGE (TWA)

TWA is Time Weighted Average (8 hours); the meter updates the reading every 60 seconds. If the meter has been powered on for less than 8 hours, the TWA value will be the weighted average of readings taken since the unit was powered ON.

### SHORT-TERM EXPOSURE LIMIT (STEL)

STEL is the Short-Term Exposure Limit (15 minutes weighted average); the meter updates readings every 60 seconds. If the meter has been powered on for less than 15 minutes, the STEL value shows the weighted average of reading taken since the unit was powered ON.

### LPS%

LPS% represents Liters per second per person.

### CFM/P

CFM/P represents Cubic Feet per Minute per person.

## VENT.R (CO<sub>2</sub>-based demand-controlled ventilation)

CO<sub>2</sub> -based demand-controlled ventilation refers to the practice of using carbon dioxide concentrations as an indicator for a per-person ventilation rate. In this context, CO<sub>2</sub> is monitored as a byproduct of respiration rather than as an indoor contaminant. The rate at which people produce CO<sub>2</sub> varies with diet and health, as well as with the duration and intensity of physical activity. The more exertion an activity entails, the more carbon dioxide is produced.

## CHANGING THE 2ND TIER DISPLAY COMBINATION

Repeated presses of the C/F-RH% button step through the following combinations of parameters:

- Humidity + Air Temperature
- Humidity + Web Bulb Temperature
- Humidity + Dew Point Temperature

## MAX/MIN MEMORY

The meter automatically records Maximum and Minimum readings when the meter is switched ON. In the normal mode, press the CO<sub>2</sub> button to see the maximum and minimum levels of CO<sub>2</sub>. While viewing the Max or Min reading, press and hold the SELECT/RECALL button to reset the MAX or MIN memory. The “Clr” icon will appear for 2 seconds and the display will begin tracking new MAX and MIN readings.

## DATALOGGER MEMORY 99 READINGS

The user can store up to 99 CO<sub>2</sub> readings in memory for later recall. Press the ESC-MEM button momentarily to save the current CO<sub>2</sub> reading with date/time stamp. The meter will emit a short beep and the memory location number will replace the RH reading for 2 seconds before returning to the RH reading.

Once the memory is full, the meter will overwrite the first data point stored and continue to overwrite existing readings as new readings are stored.

To recall the data use the SELECT/RECALL button. The middle tier display will show the memory location number and the top tier display will show the stored reading in ppm. The bottom tier display shows the date/time stamp for the displayed reading.

Press the °C/°F-RH% button momentarily to return to the normal operating mode.

Press and hold the SELECT/RECALL button to reset the 99 point memory bank, the “Clr” icon will appear for 2 seconds before returning to the normal display mode.

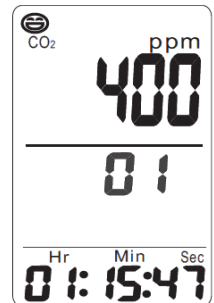

## Setup Mode

---

Press and hold the SET button for 2 seconds from the normal mode of operation to access the SETUP mode.

### Setting Year

When the two-digit year number appears, use the SELECT button to increase the year value. Press SET to move to the next setting

### Setting Month

When the two-digit month appears on the LCD press SELECT to increase the month. Press SET to save and move to the next setting.

### Setting Date

When the two-digit date appears on LCD press SELECT to increase the date. Press SET button to save and move to the next setting.

### Setting Hours

When the two-digit hour appears on the LCD press SELECT to increase the hour. Press SET to move to the next setting.

### Setting Minutes

When the two-digit minutes value appears on the LCD press SELECT to increase the minutes. Press SET to move to the next setting.

### Setting Seconds

When the two-digit seconds value appears on the LCD press SELECT to increase the seconds. Press SET to move to the next setting (high alarm below).

### High CO<sub>2</sub> Alarm

In the SETUP mode, after the date and time are set (as detailed above) the **A-on** icon will be displayed in the upper display. Press the SELECT button to switch the alarm ON or OFF. See diagram below.



When the alarm is ON, press the SET button to save the setting and move to CO<sub>2</sub> alarm setting.

The meter shows CO<sub>2</sub> 1000 ppm as the default alarm. To change the High Alarm, press the SELECT button to increase the value (press and hold the SELECT button to scroll faster). Press SET to save and press ESC to return to the normal operating mode.

Now when the reading exceeds the programmed limit the meter will beat once per second. The meter will sound the alarm until the reading does not exceed the alarm limit, the user changes the alarm limit value, the alarm is switched off as described above, or the meter power is removed.

## ***Automatic Baseline (ABC) Calibration***

---

ABC (Automatic Baseline Calibration) establishes a baseline calibration to eliminate the zero drift of the infrared sensor. The ABC function is always ON when the meter is ON. ABC is designed to calibrate the meter at the minimum CO<sub>2</sub> reading detected during 7.5 days continuous monitoring (with power on). It assumes that the area being tested receives fresh air with a CO<sub>2</sub> level of approximately 400ppm at some period of time during the seven days. **It is not suitable to use desktop CO<sub>2</sub> in closed areas with consistently high CO<sub>2</sub> levels 24 hours a day.**

NOTE: After the meter has been powered for one day, press the CO<sub>2</sub> button to determine if the environment is suitable for the automatic baseline calibration.

## ***Maintenance***

---

### **Cleaning and storage**

1. The meter should be cleaned with a damp cloth and mild detergent when necessary. Do not use solvents or abrasives.
2. Store the meter in an area with moderate temperature and humidity.



## Specifications

Function	Range	Resolution	Accuracy
CO <sub>2</sub>	0 to 9999ppm	1ppm	± (5%rdg +50ppm) from 0 to 2000ppm
Temperature	-10 to 60°C 14 to 140°F	0.1°	±0.6°C / 1.0°F
Relative Humidity	0.1 to 99.9%	0.1%	± 3% (10 to 90%) ± 5% (< 10% or > 90%) @25°C

Display	3-tier Multi-function LCD
Sensor Type	CO <sub>2</sub> : NDIR (non-dispersive infrared) technology Humidity: Capacitance sensor; Temperature (air): Thermistor
Datalogging	99 points
Operating Conditions	0 to 50°C (32 to 122°F); 5 to 80% RH
Storage Conditions	-20 to 50°C (14 to 122°F); 5 to 90% RH
Power Supply	9VDC universal plug adapter
Dimensions	155 x 87 x 81.5mm (6.1 x 3.4 x 3.2")
Weight	178g (6.2 oz.)

## Troubleshooting

<b>Meter won't power ON</b>	Check to see that the adaptor is properly plugged in.
<b>Slow response</b>	Check that the air flow channels on the rear of the meter have clearance.

### Error Codes:

<b>E-1</b>	CO <sub>2</sub> sensor is damaged	Return for repair
<b>E-2</b>	Humidity sensor is damaged	Return for repair
<b>E-3</b>	Temperature sensor is damaged	Return for repair
<b>E-4</b>	Operating temperature is too high	Put the meter in typical room temperature for 30 minutes, if problem persists, return for repair
<b>E-5</b>	Operating temperature is too low	Put the meter in typical room temperature for 30 minutes, if problem persists, return for repair
<b>E-6</b>	Hardware failed	Return for repair

# CO<sub>2</sub> Levels and Guidelines

---

## IMPORTANT LIABILITY NOTE

The CO<sub>2</sub> guideline data provided here is meant for informational purposes only and is not intended as a direct recommendation from Extech Instruments or FLIR Systems. The user must take full responsibility when determining how this information is to be used.

## Non-Enforced Reference levels

- 250 - 350 ppm – background (normal) outdoor air level
- 350- 1,000 ppm - typical level found in occupied spaces with good air exchange.
- 1,000 – 2,000 ppm - level associated with complaints of drowsiness and poor air.
- 2,000 – 5,000 ppm – level associated with headaches, sleepiness, and stagnant, stale, stuffy air. Poor concentration, loss of attention, increased heart rate and slight nausea may also be present.
- >5,000 ppm – Exposure may lead to serious oxygen deprivation resulting in permanent brain damage, coma and even death.

## Regulatory exposure limits

- ASHRAE Standard 62-1989: 1000ppm: CO<sub>2</sub> concentration in occupied building should not exceed 1000ppm.
- OSHA: 5000ppm: Time weighted average over five 8-hour work days should not exceed 5000ppm
- Building bulletin 101 (Bb101): 1500ppm. UK standards for schools say that CO<sub>2</sub> averaged over the entire day (i.e. 9am to 3.30 pm) should not exceed 1500ppm.
- Germany, Japan, Australia, UK: 5000ppm, 8 hours weighted average occupational exposure limit is 5000ppm.

**Copyright © 2013 FLIR Systems, Inc.**

All rights reserved including the right of reproduction in whole or in part in any form

**[www.extech.com](http://www.extech.com)**