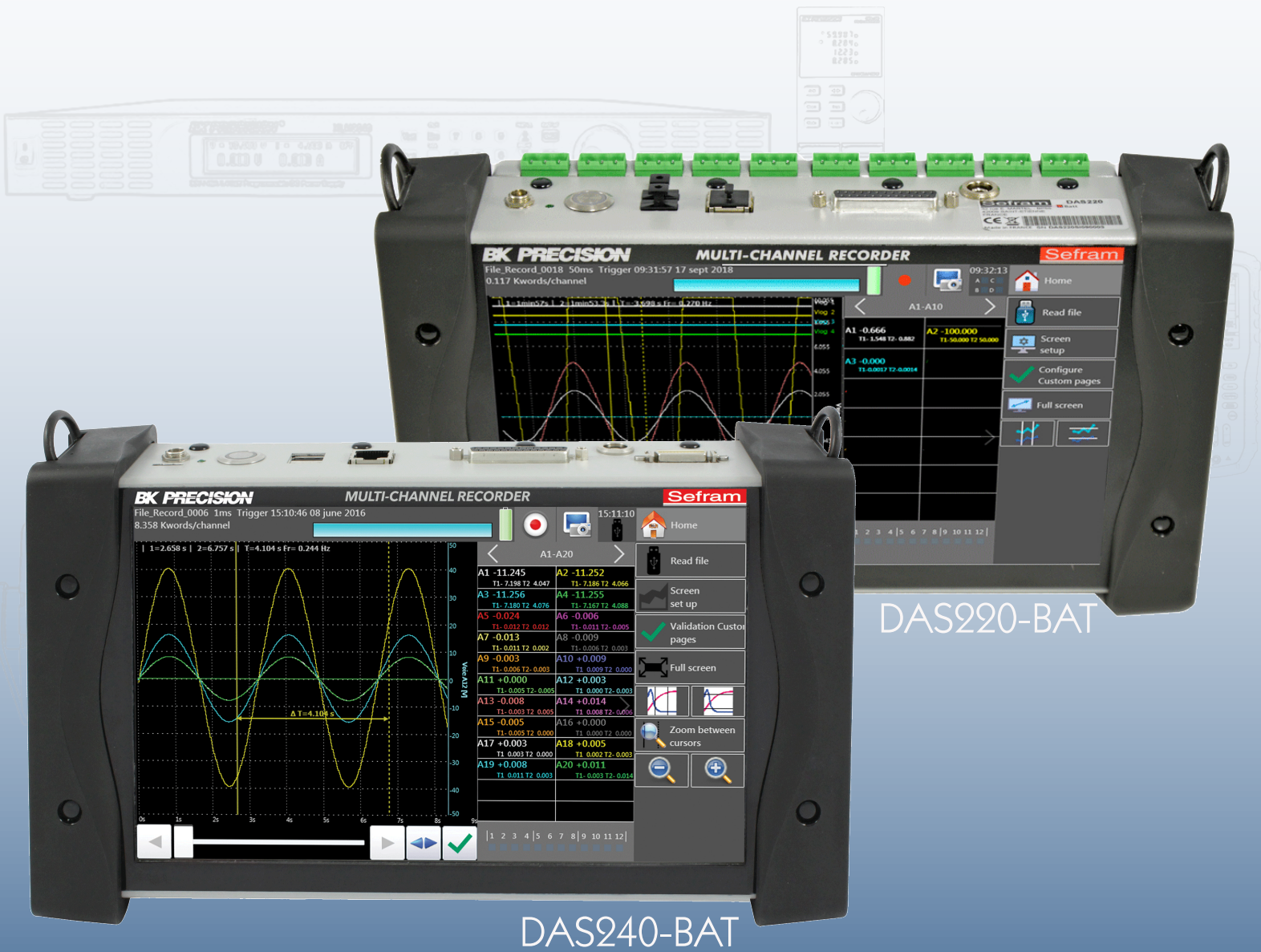


# User Manual

## DAS220-BAT & DAS240-BAT

### Portable Data Recorders



DAS220-BAT

DAS240-BAT

**BK PRECISION**

Find Quality Products Online at:

[www.GlobalTestSupply.com](http://www.GlobalTestSupply.com)

[sales@GlobalTestSupply.com](mailto:sales@GlobalTestSupply.com)

## Safety Summary

The following safety precautions apply to both operating and maintenance personnel and must be followed during all phases of operation, service, and repair of this instrument.

### WARNING

Before applying power to this instrument:

- Read and understand the safety and operational information in this manual.
- Apply all the listed safety precautions.
- Verify that the voltage selector at the line power cord input is set to the correct line voltage. Operating the instrument at an incorrect line voltage will void the warranty.
- Make all connections to the instrument before applying power.
- Do not operate the instrument in ways not specified by this manual or by B&K Precision.

Failure to comply with these precautions or with warnings elsewhere in this manual violates the safety standards of design, manufacture, and intended use of the instrument. B&K Precision assumes no liability for a customer's failure to comply with these requirements.

## Category rating

The IEC 61010 standard defines safety category ratings that specify the amount of electrical energy available and the voltage impulses that may occur on electrical conductors associated with these category ratings. The category rating is a Roman numeral of I, II, III, or IV. This rating is also accompanied by a maximum voltage of the circuit to be tested, which defines the voltage impulses expected and required insulation clearances. These categories are:

**Category I (CAT I):** Measurement instruments whose measurement inputs are not intended to be connected to the mains supply. The voltages in the environment are typically derived from a limited-energy transformer or a battery.

**Category II (CAT II):** Measurement instruments whose measurement inputs are meant to be connected to the mains supply at a standard wall outlet or similar sources. Example measurement environments are portable tools and household appliances.

**Category III (CAT III):** Measurement instruments whose measurement inputs are meant to be connected to the mains installation of a building. Examples are measurements inside a building's circuit breaker panel or the wiring of permanently-installed motors.

**Category IV (CAT IV):** Measurement instruments whose measurement inputs are meant to be connected to the primary power entering a building or other outdoor wiring.

### WARNING

Do not use this instrument in an electrical environment with a higher category rating than what is specified in this manual for this instrument.

### WARNING

You must ensure that each accessory you use with this instrument has a category rating equal to or higher than the instrument's category rating to maintain the instrument's category rating. Failure to do so will lower the category rating of the measuring system.

## Electrical Power

This instrument is intended to be powered from a CATEGORY II mains power environment. The mains power should be 115 V RMS or 230 V RMS. Use only the power cord supplied with the instrument and ensure it is appropriate for your country of use.

## Ground the Instrument

### WARNING

To minimize shock hazard, the instrument chassis and cabinet must be connected to an electrical safety ground. This instrument is grounded through the ground conductor of the supplied, three-conductor AC line power cable. The power cable must be plugged into an approved three-conductor electrical outlet. The power jack and mating plug of the power cable meet IEC safety standards.

### WARNING

Do not alter or defeat the ground connection. Without the safety ground connection, all accessible conductive parts (including control knobs) may provide an electric shock. Failure to use a properly-grounded approved outlet and the recommended three-conductor AC line power cable may result in injury or death.

### WARNING

Unless otherwise stated, a ground connection on the instrument's front or rear panel is for a reference of potential only and is not to be used as a safety ground. Do not operate in an explosive or flammable atmosphere.

### WARNING

Do not operate the instrument in the presence of flammable gases or vapors, fumes, or finely-divided particulates.

### WARNING

The instrument is designed to be used in office-type indoor environments. Do not operate the instrument

- In the presence of noxious, corrosive, or flammable fumes, gases, vapors, chemicals, or finely-divided particulates.
- In relative humidity conditions outside the instrument's specifications.
- In environments where there is a danger of any liquid being spilled on the instrument or where any liquid can condense on the instrument.
- In air temperatures exceeding the specified operating temperatures.
- In atmospheric pressures outside the specified altitude limits or where the surrounding gas is not air.
- In environments with restricted cooling air flow, even if the air temperatures are within specifications.
- In direct sunlight.

This instrument is intended to be used in an indoor pollution degree 2 environment. The operating temperature range is 0°C to 40°C and 20% to 80% relative humidity, with no condensation allowed. Measurements made by this instrument may be outside specifications if the instrument is used in non-office-type environments. Such environments may include rapid temperature or humidity changes, sunlight, vibration and/or mechanical shocks, acoustic noise, electrical noise, strong electric fields, or strong magnetic fields.

### Do not operate instrument if damaged

#### **⚠ WARNING**

If the instrument is damaged, appears to be damaged, or if any liquid, chemical, or other material gets on or inside the instrument, remove the instrument's power cord, remove the instrument from service, label it as not to be operated, and return the instrument to B&K Precision for repair. Notify B&K Precision of the nature of any contamination of the instrument.

### Clean the instrument only as instructed

#### **⚠ WARNING**

Do not clean the instrument, its switches, or its terminals with contact cleaners, abrasives, lubricants, solvents, acids/bases, or other such chemicals. Clean the instrument only with a clean dry lint-free cloth or as instructed in this manual. Not for critical applications

#### **⚠ WARNING**

This instrument is not authorized for use in contact with the human body or for use as a component in a life-support device or system.

### Do not touch live circuits

#### **⚠ WARNING**

Instrument covers must not be removed by operating personnel. Component replacement and internal adjustments must be made by qualified service-trained maintenance personnel who are aware of the hazards involved when the instrument's covers and shields are removed. Under certain conditions, even with the power cord removed, dangerous voltages may exist when the covers are removed. To avoid injuries, always disconnect the power cord from the instrument, disconnect all other connections (for example, test leads, computer interface cables, etc.), discharge all circuits, and verify there are no hazardous voltages present on any conductors by measurements with a properly-operating voltage-sensing device before touching any internal parts. Verify the voltage-sensing device is working properly before and after making the measurements by testing with known-operating voltage sources and test for both DC and AC voltages. Do not attempt any service or adjustment unless another person capable of rendering first aid and resuscitation is present.

Do not insert any object into an instrument's ventilation openings or other openings.

#### **⚠ WARNING**

Hazardous voltages may be present in unexpected locations in circuitry being tested when a fault condition in the circuit exists.

#### **⚠ WARNING**

Fuse replacement must be done by qualified service-trained maintenance personnel who are aware of the instrument's fuse requirements and safe replacement procedures. Disconnect the instrument from the power line before replacing fuses. Replace fuses only with new fuses of the fuse types, voltage ratings, and current ratings specified in this manual or on the back of the instrument. Failure to do so may damage the instrument, lead to a safety hazard, or cause a fire. Failure to use the specified fuses will void the warranty.

### Servicing












#### **⚠ WARNING**

Do not substitute parts that are not approved by B&K Precision or modify this instrument. Return the instrument to B&K Precision for service and repair to ensure that safety and performance features are maintained.

### For continued safe use of the instrument

- Do not place heavy objects on the instrument.
- Do not obstruct cooling air flow to the instrument.
- Do not place a hot soldering iron on the instrument.
- Do not pull the instrument with the power cord, connected probe, or connected test lead.
- Do not move the instrument when a probe is connected to a circuit being tested.

### Safety Symbols

Symbol	Description
	indicates a hazardous situation which, if not avoided, will result in death or serious injury.
	indicates a hazardous situation which, if not avoided, could result in death or serious injury
	indicates a hazardous situation which, if not avoided, will result in minor or moderate injury
	Refer to the text near the symbol.
	Electric Shock hazard
	Alternating current (AC)
	Chassis ground
	Earth ground
	This is the In position of the power switch when instrument is ON.
	This is the Out position of the power switch when instrument is OFF.
	is used to address practices not related to physical injury.

# Contents

1	Introduction	6
1.1	Electrical Connections	6
1.2	DAS240-BAT Extension Module	6
1.3	Home screen	8
1.4	Recording Period	8
1.4.1	Example: Recording 9 Channels	9
1.4.2	Example: Power-Line, engine noise, or other electrical noise.	9
2	Setup	10
2.1	Switching On	10
2.1.1	Switching Off	10
2.1.2	In Case of Error	11
2.2	Extension Modules (DAS240-BAT only)	11
2.3	External Power	12
2.4	Battery	12
2.4.1	To Ensure Long Battery Life	12
2.4.2	To Charge the Battery	13
2.5	Calibration	13
2.5.1	Factory Default Calibration	13
2.6	Keypad Lock	14
2.7	System Setup	14
2.8	Language	14
2.9	Screen Shut Off (Dimming)	15
2.10	VNC	15
2.11	Additional Options	15
2.12	Firmware Update	15
2.13	Instrument Configuration Loading and Saving	15
2.14	Network	15
2.15	Alarms	16
3	Channel Setup	17
3.1	All Channels Screen	17
3.2	Individual Channel Screen	17
3.3	Extension Modules (DAS240-BAT only)	17
3.4	Measurement Connections	18
3.4.1	Voltage Measurement	18
3.4.2	Temperature Measurement With a Thermocouple	19
3.4.3	Temperature Measurement With Pt100/Pt1000 and RTD	19
3.4.4	Resistance Measurement	19
3.4.5	Current Measurement	20
4	F(t) Plot	22
4.1	Screen Setup	22
4.1.1	Custom Pages	23
4.2	Freeze Screen and Cursor Measurements	23
4.3	Time Base	24
4.4	Math	24
4.4.1	Math Functions	25
5	XY Plot	29
6	Numeric Display	31

7	Recording	32
7.1	Create a Recording	32
7.2	View Recording	32
7.2.1	Loading a Recording	32
8	Triggering Recordings	35
8.1	Waiting Start Condition	35
8.2	Recordings	35
8.3	Triggering	36
8.3.1	Single Analog Channel Trigger	36
8.3.2	Single Threshold	37
8.3.3	Multiple Thresholds	38
8.3.4	Trigger Examples	39
8.4	Trigger on Logic Channels	39
9	Alarms	40
9.1	Alarm Status	40
9.2	Analog/Math/Timing Signal Alarm	41
9.3	Analog Signal Combination Alarm	41
9.4	Logic (Digital) Signal Alarm Trigger	42
9.5	Alarm on Recording Start (Trigger Acquisition)	43
10	Logic Channels	44
10.1	Logic Input Connector	44
10.2	Logic Channel Setup	44
10.3	Timing	45
10.4	Alarm Outputs	45
11	File Management	47
11.1	Note:	47
11.1	Setup Files	47
11.1.1	Default	48
11.1.2	Save Setup Files	48
11.1.3	Load Setup Files	48
11.2	Recordings Files	48
12	Remote Interfaces	49
12.1	LAN Interface	49
12.1.1	LAN Setup	49
12.2	VNC	49
12.2.1	Changing the Password	49
12.3	Network File Transfer	49
12.4	Viewing with SeframViewer	50
12.4.1	Example	51
12.5	Device Control with DASLab	52
12.6	Modbus (slave)	53
12.6.1	Setup Modbus Slave	53
12.6.2	Mapping Modbus TCP	53
12.6.2.1	Analog Data	53
12.6.2.2	Logical Data	53
13	Maintenance	55
13.1	Updating the Internal Software	55
14	Specifications	56
15		57
16		57

17	Thermocouple Measurement Accuracy	57
17.1	J Type Thermocouple Example	57
17.2	Measurement Accuracy: Pm	57
17.3	Voltage of Thermocouple (mV)	57
17.3.1	Example of Accuracy Calculation	58
17.4	Accuracy Class - Class Index	58
17.5	Grounding	58
18	LIMITED TWO-YEAR WARRANTY	60
19	Service Information	61



# Introduction



**Figure 1.1** Front View

The DAS240-BAT and DAS220-BAT programmable recorders can measure voltage, current, temperature (thermocouple, Pt100, Pt1000), resistances, and logic channels. Highlights include:

- An intuitive interface on a wide capacitive and color 10" touchscreen
- 32GB internal memory for storing recordings
- Composed of a main base frame and extension modules of 20 channels each
- Programmable via Ethernet using NTP, FTP and VNC protocols
- Built-in battery with capacity to run the recorder for hours

Model	Channels
DAS240-BAT	20-200 using expansion blocks
DAS220-BAT	10

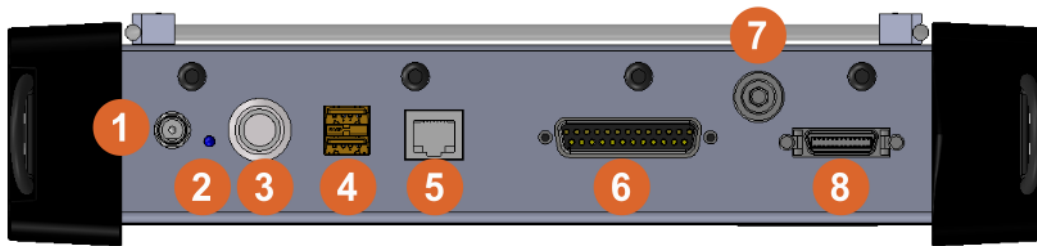
**Table 1.1** Channel Options

## 1.1 Electrical Connections

Connection to the recorders uses modular connectors shown in [Figure 1.2](#) and [Figure 1.3](#).

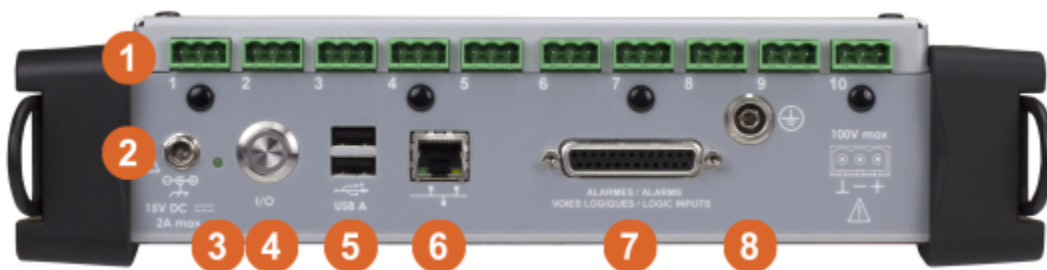
## 1.2 DAS240-BAT Extension Module

Signals are connected to the unit via terminal blocks, see [Figure 1.4](#). These blocks accommodate 20 connections each and may be chained together to provide more channels.



Item	Description
1	Power Connector
2	Charging LED
3	ON/OFF Switch
4	USB Connectors
5	LAN Interface
6	Logic and Alarm Signals
7	Ground
8	Expansion Module

Figure 1.2 DAS240-BAT Electrical Connections



Item	Description
1	Channel Inputs
2	Power Connector
3	Charging LED
4	ON/OFF Switch
5	USB Connectors
6	LAN Interface
7	Logic and Alarm Signals
8	Ground

Figure 1.3 DAS220-BAT Electrical Connections

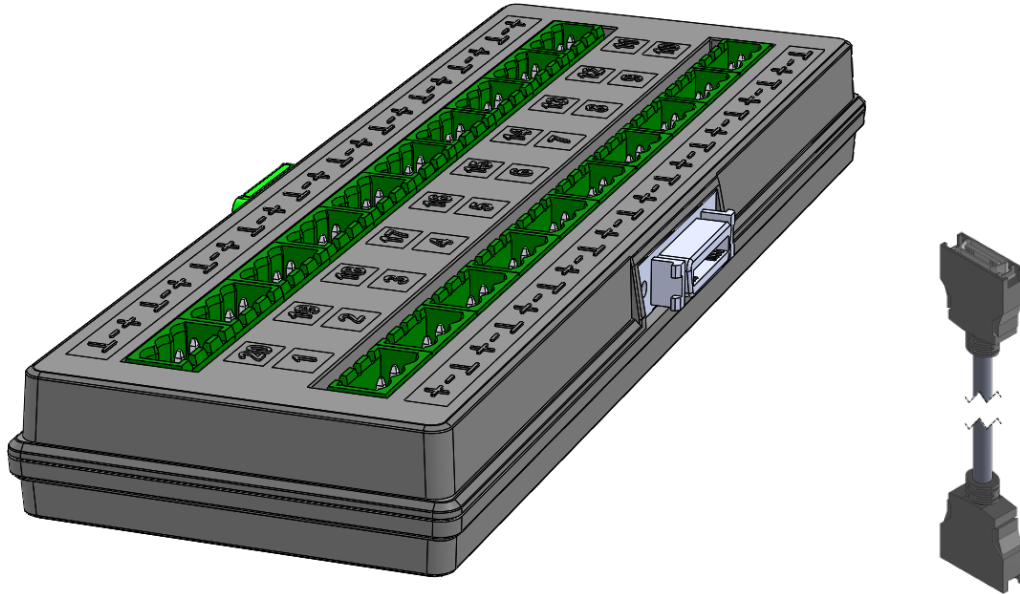
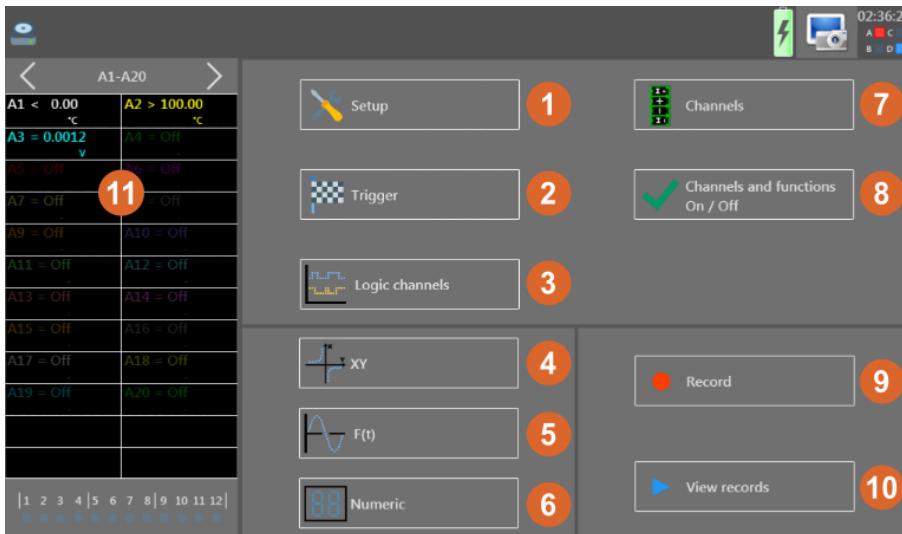


Figure 1.4 Terminal Block and Cable

### 1.3 Home screen

The home screen provides access to the various functions and settings of the unit. Access this menu via the “Home” button in the top right corner of the screen.



Item	Description
1	Setup Menu
2	Trigger Menu
3	Logic Channel Config Menu
4	XY Display
5	F(t) Display
6	Numeric Display
7	Channel Setup Menu
8	Channel and Function Display Config
9	Recording Display
10	Recording Replay Screen
11	Channel Configuration Screen

Figure 1.5 Home Screen

### 1.4 Recording Period

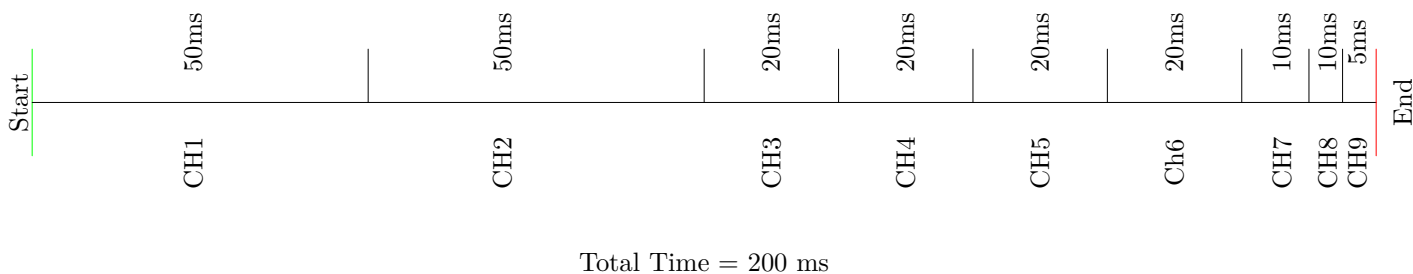
The acquisition sample rate is configurable. The unit samples one channel at a time. The sample period defines the time a sample consumes.

**Note:** Each channel is sampled in sequence. The effect is that the rate at which a channel is sampled depends on the number of channels and the sample period of each channel. See [Section 1.4.1](#)

The sample period is set to one of the following settings: 1, 2, 5, 10, 20, 50 and 100ms. When 3-wire thermocouple measurements (Pt100 and Pt1000) are made, the time periods are doubled. The doubled time periods are highlighted in the channel setup dialog with a "(x2)" beside the period. Also, by using a configurable low-pass filter per channel, measurements can be made filtering out higher frequency components.

### 1.4.1 Example: Recording 9 Channels

For example, if 9 channels are sampled, and the settings for each channel sample period are [50, 50, 20, 20, 20, 20, 10, 10, 5] ms each, the total time for an acquisition is 200 ms. Consequently, the minimum recording period, the time between samples of an individual channel, is 200 ms. See **Figure 1.6**.



**Figure 1.6** 9ch Ex.

### 1.4.2 Example: Power-Line, engine noise, or other electrical noise.

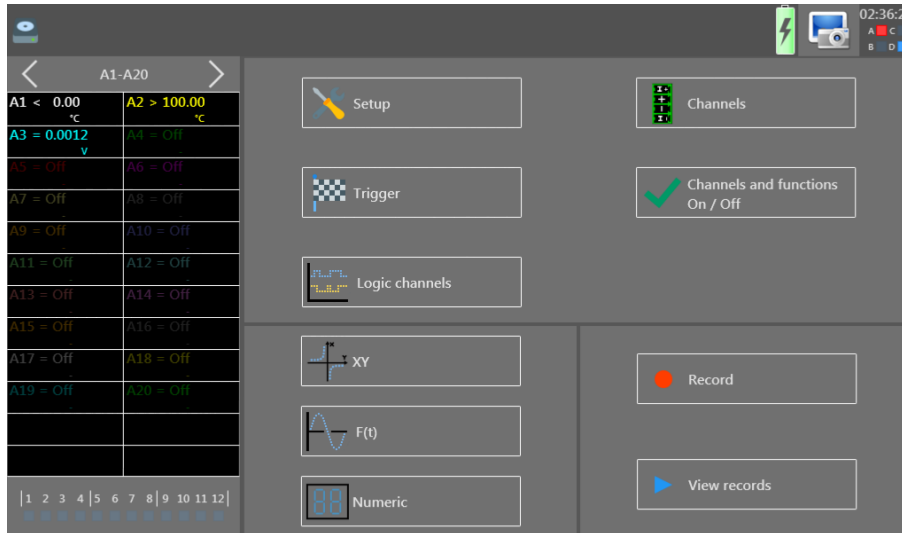
For white noise or noise with lower frequency (lower than recording frequency), you can choose a software filter.

# Setup

## 2.1 Switching On

Prior to powering ON the unit, connect the extension modules<sup>1</sup> (DAS240-BAT).

Turn on the recorder by pressing the button at the top. When the recorder is on, the ON/OFF button will illuminate, and displays a startup screen showing the hardware version. It then switches automatically to “F(t)” mode. This display is accessible from the “Home” menu, **Figure 2.1**, by pressing the “F(t)” key.

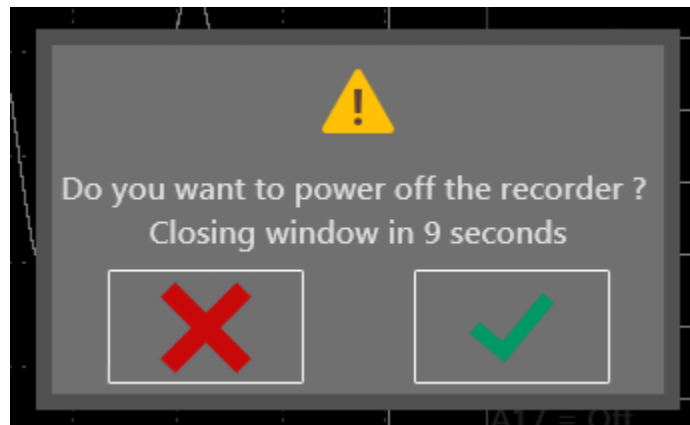


**Figure 2.1** Home Screen

On power-up, the unit recalls the last settings and configurations used.

### 2.1.1 Switching Off

To switch off the recorder, press the ON/OFF button. A dialog box appears prompting the user to confirm powering off the unit. Select the green check mark to proceed. The dialog disappears if either the red “X” is pressed or the 10 s countdown expires. Before the unit turns off, the setup will be saved and the current file will be closed.



**Figure 2.2** On Off Dialog

<sup>1</sup> If there are no modules connected or detected, the will display “Error!” in the lower right hand corner of the startup screen.

If the recorder does not switch off correctly, then press the ON/OFF button for 5 seconds. Configurations and setup values may not be saved in this case. This is also true if the unit loses power.

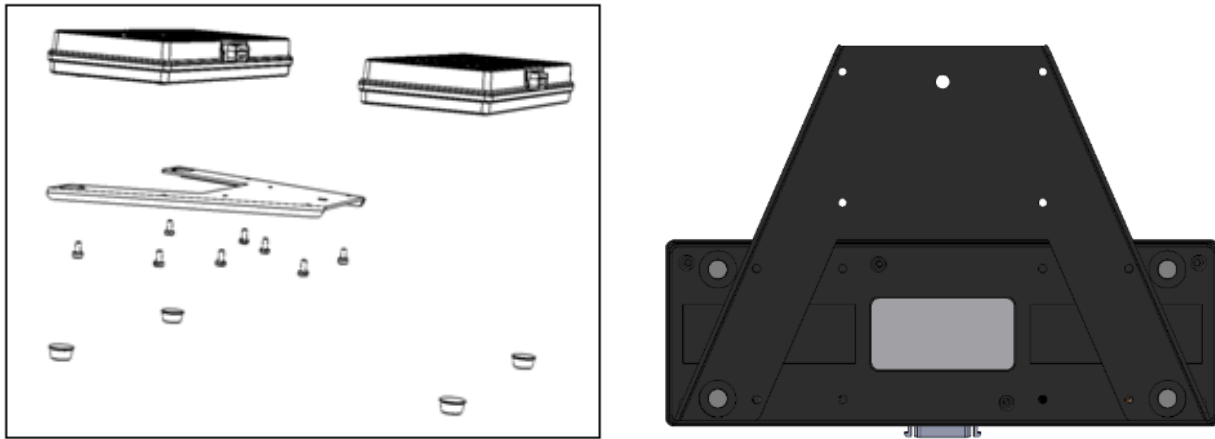
### 2.1.2 In Case of Error

- If the unit still starts normally: reinitialize to default settings. From the main menu open the “Setup” menu, then click on “Default setup” key. See [Section 2.7](#).
- Alternatively, the unit can be reset to factory defaults.
  - With the unit power off, press the power button to turn the unit on.
  - While the unit is booting up, quickly and repeatedly press power button until the display shows a white startup screen. A setup\_error.cnf file will be created in the root folder of the internal memory.
  - The unit resets to defaults and reverts to French.
  - To change the language back to English, press “Menu Principal”, then “Configuration”, then press the French flag and select the British flag for English.

**Note:** If errors persist, please contact B&K Precision for further assistance.

## 2.2 Extension Modules (DAS240-BAT only)

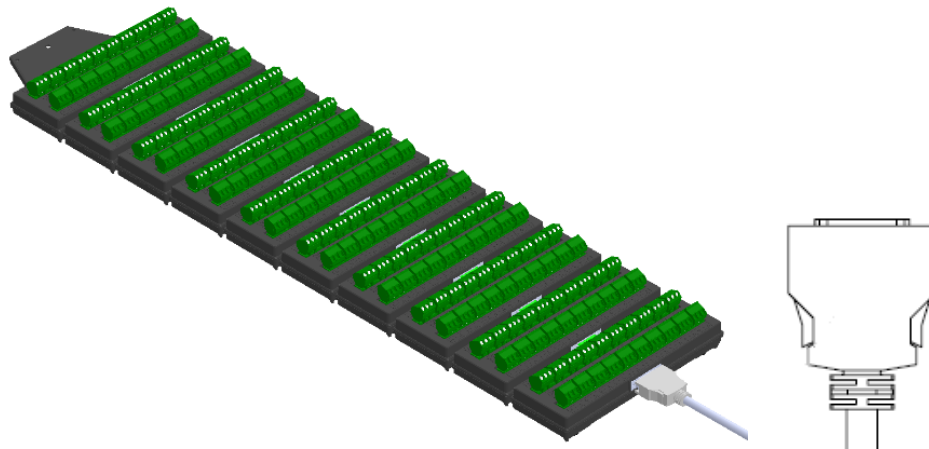
Up to 10 extension modules may be connected at a time.



**Figure 2.3** Extension Modules

To assemble multiple terminal block modules:

- Screw the electrical connectors' plate to each additional extension
- Assemble the extension modules together
- Screw the plates with the adjacent modules
- Stick the additional adhesive buttress
- Connect the cable using unlocking levers
- Connect the cable on the DAS240-BAT (must be powered off first)
- Switch on the unit.



**Figure 2.4** Breakout Cable and Module

**Note:** The unit is delivered with a 70 cm cable.

## 2.3 External Power

The DAS240-BAT and DAS220-BAT recorders are powered and charged using a 15V DC, 5A power supply.

**Warning:** To minimize the risk of shock, the instrument chassis and cabinet must be connected to an electrical safety ground. This instrument is grounded through the ground conductor of the supplied, three-conductor AC line power cable. The power cable must be plugged into a three-conductor electrical outlet.

**Warning:** When the charger is connected to the unit, the chassis is connected to the power supply earth ground.

## 2.4 Battery

The unit is equipped with a lithium-ion battery. If the unit has remained unused for more than one month, check its charge status and recharge it if necessary.

For continued safe use:

- Never heat up or expose the battery pack to fire
- Never short the battery: there is a risk of explosion!
- Do not puncture the battery.
- Do not dismantle the battery pack.
- Do not reverse the polarities of the battery.
- This battery pack includes protection that should not be damaged or removed.
- Do not store the pack in a place exposed to excessive heat.
- Do not damage the protective sheath of the pack.
- Do not store inside a vehicle exposed to the sun.

The battery should last at least 200 full charge-discharge cycles or 2 years.

### 2.4.1 To Ensure Long Battery Life

- Do not store for a long time without use.
- Store the battery at around 40% charge.
- Do not fully charge or discharge the battery before storage.

When the battery is nearly discharged, the unit closes all open files, stops the software, and will shut off automatically.

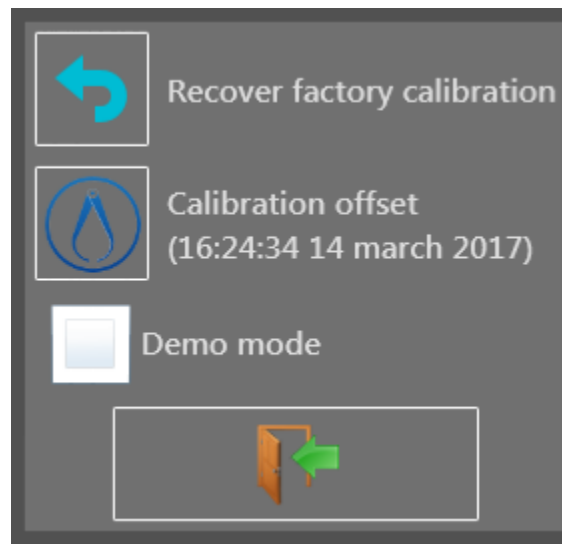
### 2.4.2 To Charge the Battery

- Connect the provided external AC adapter to the power input of the unit.
- Connect the AC adapter to a electrical outlet.
- The green LED will light when the battery is charging and will turn off when charging is complete.
- Charging can be done with the unit turned on or off.

**Note:** Battery replacement and service should be performed by B&K Precision. Contact us for details.

## 2.5 Calibration

The recorder inputs for the voltage and thermocouple offsets can be calibrated. This will remove any offset present on different channels.



**Figure 2.5** Offset Calibration Screen

1. Let the unit warm up for 20 minutes at ambient temperature 68-77F (20-25C).
2. Enter the recorder main page and then press the “Setup” key.
3. Select the “Additional Option” menu.
4. Select the “Electric Calibration” menu.
5. Press the “Calibration offset” to start calibration. This takes approximately 5 minutes.
6. Power cycle the unit.

### 2.5.1 Factory Default Calibration

The default factory calibration can be restored to correct any possible mistake in the calibration coefficients. This restores calibration values configured at the factory. This is performed as follows:



1. Let the unit warm up for 20 minutes at ambient temperature 68-77F (20-25C).
2. Enter the recorder main page and then press the “Setup” key.
3. Select the “Additional Option” menu.
4. Select the “Electric Calibration” menu.
5. Press the “Recover factory calibration”.
6. Power cycle the unit.

## 2.6 Keypad Lock

To lock all keys:

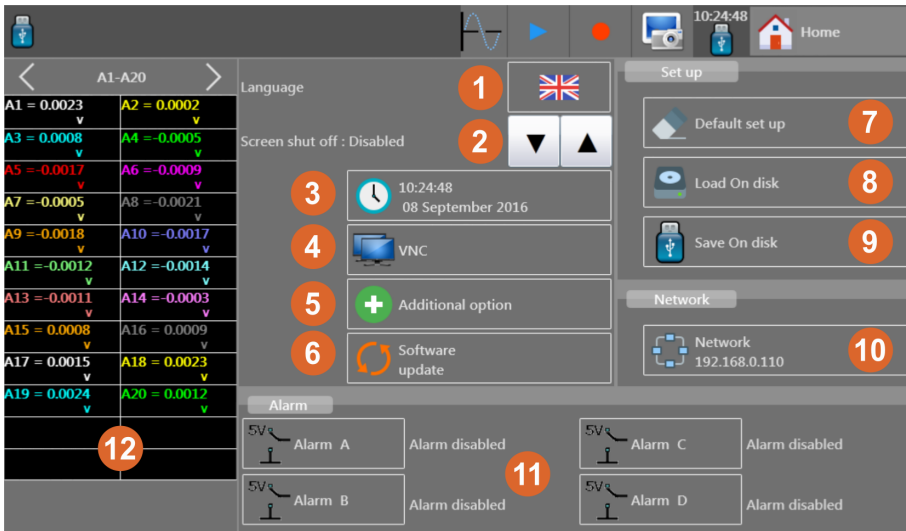
- Press the “Setup” key.
- Press the “Additional Option” key.
- Press the “Locking the recorder” key.
- Press the green check mark to confirm and lock the unit.

The keypad lock will occur 10 seconds after confirmation.

A yellow padlock appears in the upper right corner of the display when locked. To unlock the recorder, press the lock icon in the upper right corner repeatedly.

## 2.7 System Setup

The Setup Menu provides access to general setup of the instrument, monitoring of the alarm outputs, network address TCP/IP, calibration of the channels, and software (firmware) updating. The setup menu is shown in **Figure 2.6**.



Button	Description
1	Language
2	Screen dimming time
3	Date and time setup
4	VNC setup
5	Additional settings
6	Update
7	Load default settings
8	Load configuration from disk
9	Save configuration to disk
10	Network status and setup
11	Alarms
12	Channels

Figure 2.6 Setup Menu

## 2.8 Language

The system language can be set to one of the following: French, Spanish, English, Italian, German, and Swedish. Open the language dialog by pressing the flag icon on the setup screen (Home>Setup). Then select the flag icon that correlates to the language, **Figure 2.7**.



Figure 2.7 System Languages

## 2.9 Screen Shut Off (Dimming)

The amount of time the screen back-light stays at full brightness may be set from 1-30 mins or (disabled). Use the arrow keys to change the screen shut off timeout.

## 2.10 VNC

VNC (Virtual Network Computing) allows the user to mirror the front panel using a viewer on a networked computer. This button is for setting the password. See [Section 12.2](#) for more details.

## 2.11 Additional Options

Setting the screen brightness, locking the screen, calibrating the machine, setting the start-up screen image and settings for the Modbus server are available in this menu. See [Section 2.5](#) for calibration information, and see [Section 2.6](#) for screen lock information.

## 2.12 Firmware Update

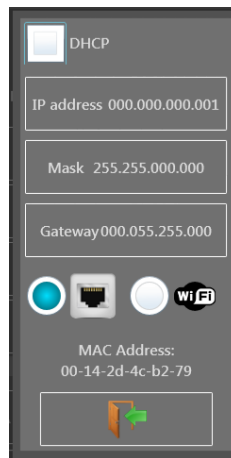
See [Chapter 13](#) for details about updating the firmware.

## 2.13 Instrument Configuration Loading and Saving

Settings like the F(t) time/division and channels to display may be saved and recalled by the instrument. Also, a default set of settings may also be loaded. These can be configured with the 3 buttons in the “Setup” box of the setup display window (home>setup).

## 2.14 Network

The current IP addresses of the network is shown within the network button. If there is no network connection, 0.0.0.0 is shown.



**Figure 2.8** Network Configuration Dialog

Pressing the button opens the network configuration dialog. Available options are shown in this window depending on the hardware connected. DHCP, IP Address, Subnet Mask, and Gateway IP can be configured here.

---

## 2.15 Alarms

---

See **Chapter 9** for details.

# Channel Setup

## 3.1 All Channels Screen

Access the channel setup menu from the Home screen and press the “Channels” button. The screen shown in **Figure 3.1** appears.



	A1	A2	A3	A4	A5	A6	A7	A8	A9	A10	
Name	Channel A1	Channel A2	Channel A3	Channel A4	Channel A5	Channel A6	Channel A7	Channel A8	Channel A9	Channel A10	Name
Type	Voltage	Voltage	Voltage	Voltage	Voltage	Voltage	Voltage	Voltage	Voltage	Voltage	Type
Filter	No filter	No filter	No filter	No filter	No filter	No filter	No filter	No filter	No filter	No filter	Filter
Samp. Period	1 ms	1 ms	1 ms	1 ms	1 ms	1 ms	1 ms	1 ms	1 ms	1 ms	Samp. Period
Function	Disabled	Disabled	Disabled	Disabled	Disabled	Disabled	Disabled	Disabled	Disabled	Disabled	Function
Range	5 V	10 V	10 V	10 V	10 V	10 V	10 V	10 V	10 V	10 V	Range
Center zero	0 V	0 V	0 V	0 V	0 V	0 V	0 V	0 V	0 V	0 V	Center zero
Max.	2.5 V	5 V	5 V	5 V	5 V	5 V	5 V	5 V	5 V	5 V	Max.
Min.	-2.5 V	-5 V	-5 V	-5 V	-5 V	-5 V	-5 V	-5 V	-5 V	-5 V	Min.
Threshold T1	0.5 V	0.5 V	0.5 V	0.5 V	0.5 V	0.5 V	0.5 V	0.5 V	0.5 V	0.5 V	Threshold T1
Threshold T2	-0.5 V	-0.5 V	-0.5 V	-0.5 V	-0.5 V	-0.5 V	-0.5 V	-0.5 V	-0.5 V	-0.5 V	Threshold T2

**Figure 3.1** Channels Menu

The channel configuration screen provides quick access to individual channel settings. Each column lists a set of values for each channel. The parameter available is listed in the left and right most columns. Pressing the box corresponding to the channel and parameter opens a dialog box with options for configuring that parameter. The contents of the dialog change depending on the selected parameter value. For example, when the channel type parameter is opened, selecting the Thermocouple value modifies the box to give further options for thermocouples (type, temperature units, etc...). Back on the main channel table, the value in the box shows a summary version of the parameter’s configured value. In the upper right and left corners of the table are navigation arrows for showing more sets of channels. 10 channels may be shown on screen at a time.

## 3.2 Individual Channel Screen

The complete set of parameters, values and options are also viewable for a single channel on a single screen. To open this screen, press the box displaying the Channel ID (A1 for example). This opens a window for setting a greater number of values than available from the channels table. For example, the plot color and thickness can be set here. See **Figure 3.2**.

## 3.3 Extension Modules (DAS240-BAT only)

Up to 10 extension modules may be connected at a time.  
To assemble multiple terminal block modules:

- Screw the electrical connectors’ plate to each additional extension
- Assemble the extension modules together
- Screw the plates with the adjacent modules
- Stick the additional adhesive buttress

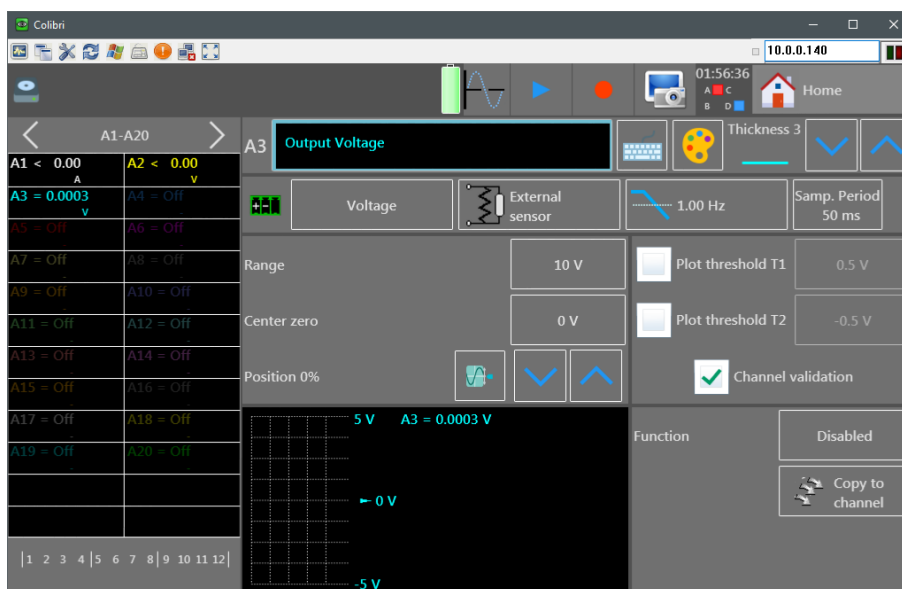


Figure 3.2 Channel Configuration Screen

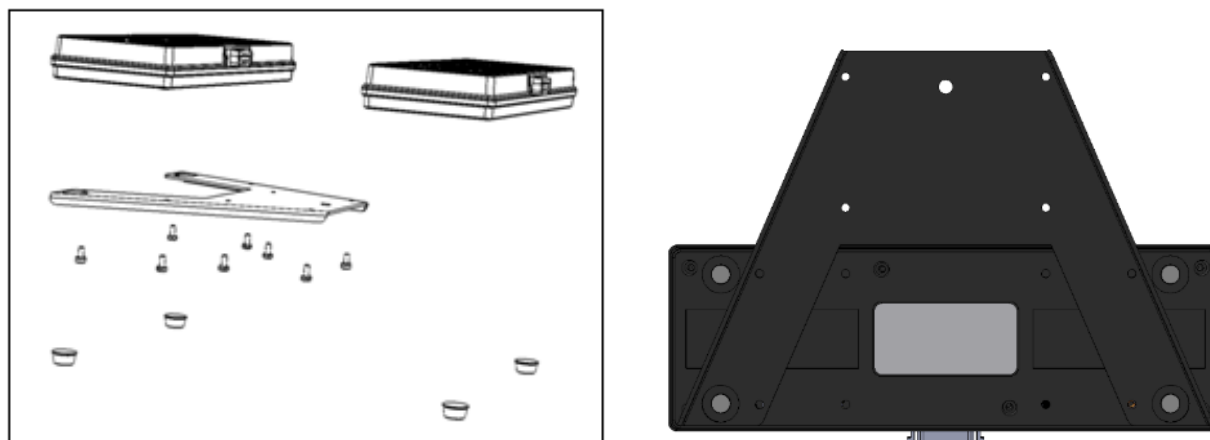


Figure 3.3 Extension Modules

- Connect the cable using unlocking levers
- Connect the cable on the DAS240-BAT (must be powered off first)
- Switch on the unit.

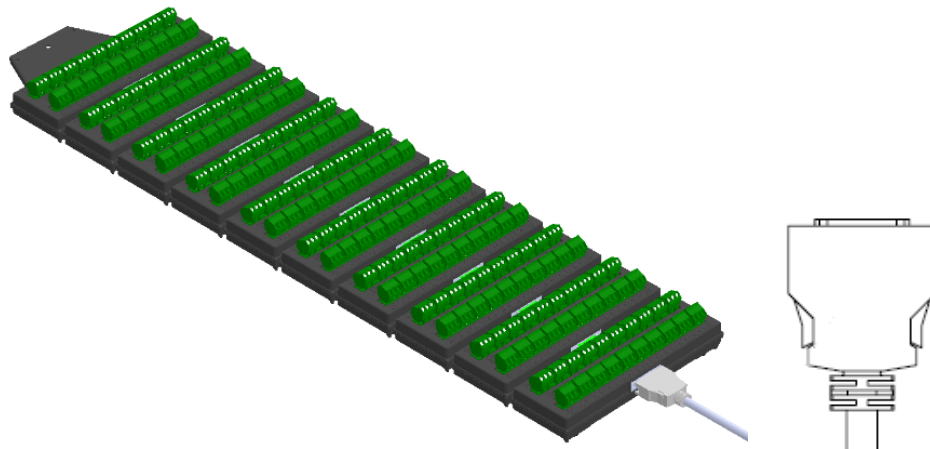
**Note:** The unit is delivered with a 70 cm cable.

## 3.4 Measurement Connections

Using the terminal blocks provided with the unit. **Figure 3.5.** (Phoenix Contacts: SMSTB 2,5/3-ST5,08 - 1826296)

### 3.4.1 Voltage Measurement

Voltage measurement is performed between the + and - terminals of the inputs. The "GND" terminal is not used.



**Figure 3.4** Breakout Cable and Module



**Figure 3.5** Terminal Blocks

### 3.4.2 Temperature Measurement With a Thermocouple

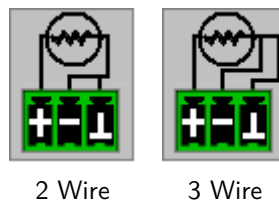
The voltage resulting from thermocouple is measured between the + and - terminals of the relevant input. The “GND” terminal is not used. Errors in reading temperature can be caused by reverse connection of the thermocouple wires.

### 3.4.3 Temperature Measurement With Pt100/Pt1000 and RTD

The Pt100/Pt1000 probe must be connected to the + and - terminals. The current injects into the “GND” terminal. For a 4 wire Pt100/Pt1000, only 3 wires are used.

**Note:** the “gnd” current injection is shared by all channels.

**Figure 3.6** shows 2 ways to wire the temperature sensors. Using the 2-wire method, the “-” and “GND” terminals are connected together at the terminal block. For 3-wire, the ground connects at the measurement point.



**Figure 3.6** Terminal Block Wiring

### 3.4.4 Resistance Measurement

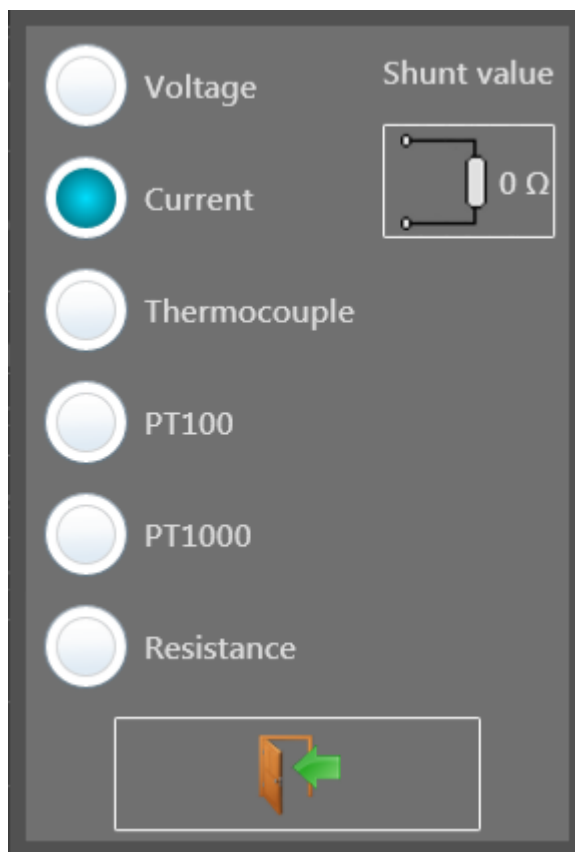
Connect the resistance to measure between the “+” and “-” terminals and connect the “-” and “GND” terminals together. For best resolution and accuracy, configure the resistance display range appropriately for the expected value. For example,

set the on screen range close to the expected measurement value. Based on the range chosen, the unit determines the sense current and voltage range to use for measurement.

### 3.4.5 Current Measurement

The recorder includes the option to convert sensed voltage across a shunt or sense resistor into a current reading. From the “Home” screen, open the “Channels” menu. The “Type” row shows the current function per channel. Press the square in the “channel” column and “Type” row to open the configuration dialog for the function type. See [figure 3.7](#). Select the “Current” menu option. The window will change to show a button listing the current shunt value. To change the value, press the button and a dialog for setting the shunt value will open. See [Figure 3.8](#). Set the value and unit and press the green check mark to confirm the setting and the screen will return to the previous menu.

To wire the circuit for current measurement, connect the “+” and “-” terminals to the current shunt. Also, set the current range in the “Channels” window appropriately. Use either an external resistance or a shunt (ref 902406500: 50 $\Omega$  [Figure 3.9](#)).



**Figure 3.7** Channel Function Type

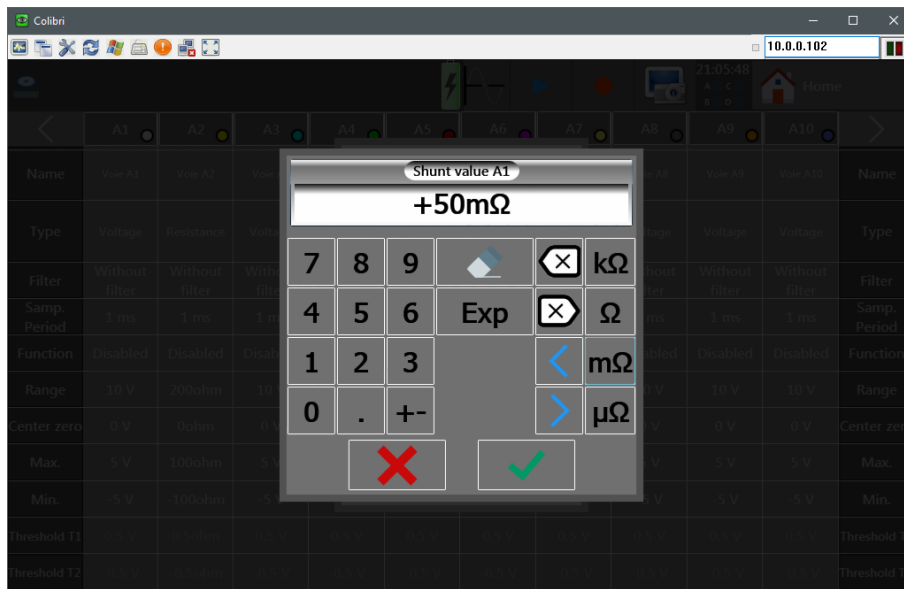


Figure 3.8 Current Shunt Value Setup

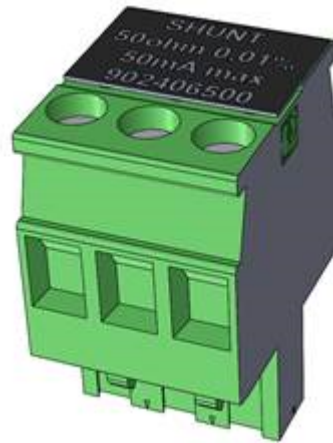
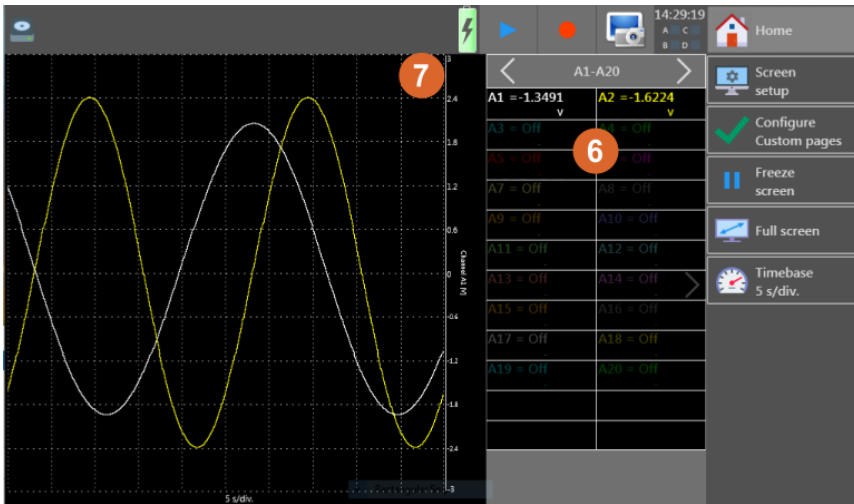


Figure 3.9 50Ω Shunt Module



# F(t) Plot

This mode displays the channel signals versus time, much like an oscilloscope. The time per division is called the “Timebase” on this unit. The display is normally in a scrolling mode displaying real time data. This changes when recording data. In that case, the display shows the full record. See [Chapter 7](#) for more information about recording data.



Item	Description
1	Screen Setup, <a href="#">Section 4.1</a> .
2	Configure custom pages, <a href="#">Section 4.1.1</a>
3	Freeze Screen, <a href="#">Section 4.2</a>
4	Full Screen - change the view to full screen, touch the screen anywhere to exit.
5	Timebase, <a href="#">Section 4.3</a>
6	Numerical display - display the current signal value and control which channel page is displayed.
7	F(t) plot

Figure 4.1 F(t) Screen

## 4.1 Screen Setup

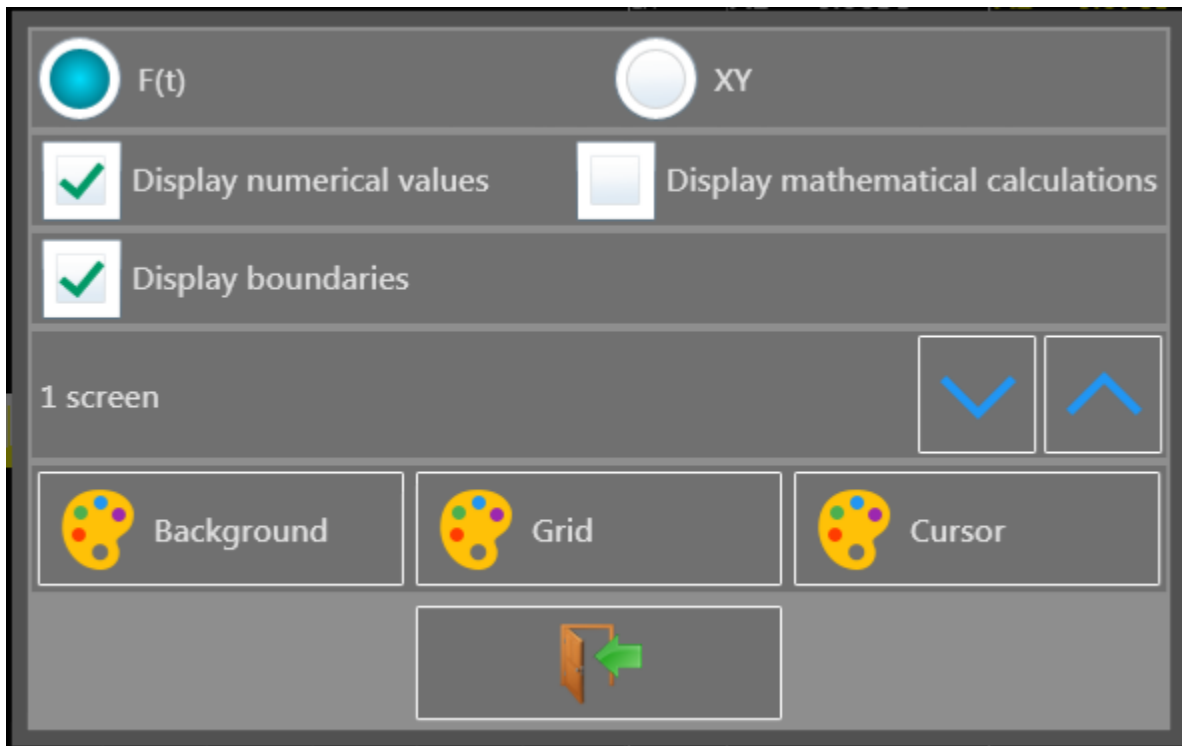
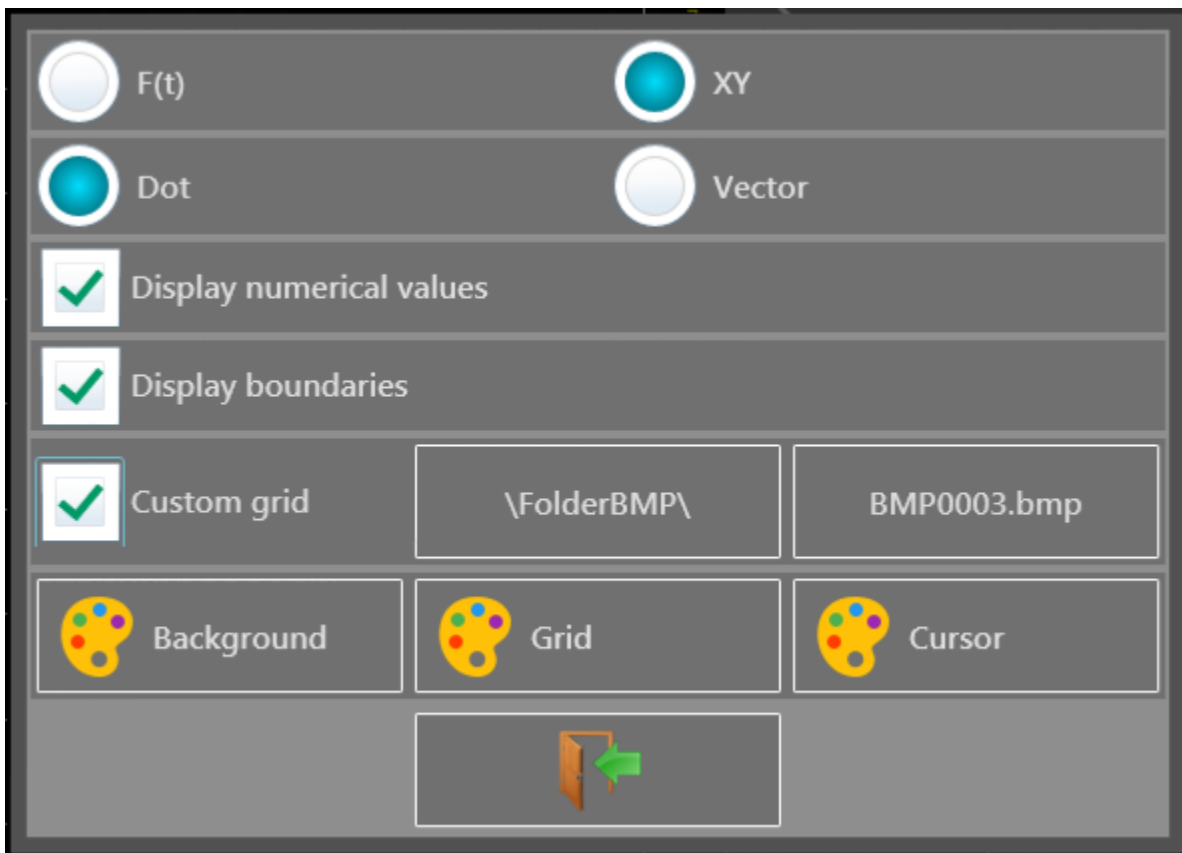


Figure 4.2 Screen Setup Dialog

From this dialog, the type of plot, numerical values, math, grid scales, number of plots, and colors are set here. The number of plots is available when in F(t) mode, and is limited to the number of signals measured. The maximum number is 10. When in XY mode, the number of plots is replaced by the option to enable a custom grid (background image). When a custom grid is enabled, the options of directory and file are added to the dialog as in [Section 4.3](#). Lastly, the choice of displaying points as dots or vectors is available for the XY display mode.



**Figure 4.3** Screen Setup Dialog - XY mode

#### 4.1.1 Custom Pages

Using this menu, set the channels to see on screen from the available channels set using the “Channels and Functions On/Off” menu. The channels are divided into banks and the shown bank is set here. For example, this allows channels 1 and 10 to be shown on the screen and turn off other channels.

#### 4.2 Freeze Screen and Cursor Measurements

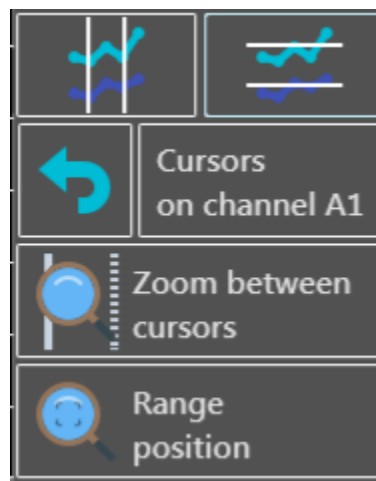
Freezes the graph at the screen to perform measurements through cursors, calculations, save or print the measurements at screen, in the F(t) mode.

When frozen, horizontal and vertical cursor icons are added to the right-hand panel. Selecting the vertical cursor icon



enables time based cursors. Move the individual cursors by the touchscreen or other mouse interface to set the

cursor positions. selecting the horizontal cursor icon  changes the available buttons in the right hand panel, See [Figure 4.4](#).



**Figure 4.4** Horizontal  
Cursor Options

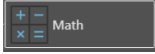
Icon	Description
	Undo the last cursor action completed.
	Opens a dialog box for setting the signal to measure with the cursors.
	Zoom the selected channel to fit within the current cursor settings.
	Set the vertical axis parameters for the selected channel. The range is the vertical span of the channel. The center value defines what value is the middle of the axis. The "Position" defines the vertical location of the horizontal axis (time) in percentage. The range is from -100 to 100 %. For example, -50 will place the horizontal axis at 2.5 divisions above the bottom of the display. All together, the range sets how many volts tall the vertical axis is, center sets the

### 4.3 Time Base

The trace time scale may be set to a number of values. Pressing the Timebase button on the right of the F(t) plot screen brings up the dialog as shown in [Figure 4.5](#).

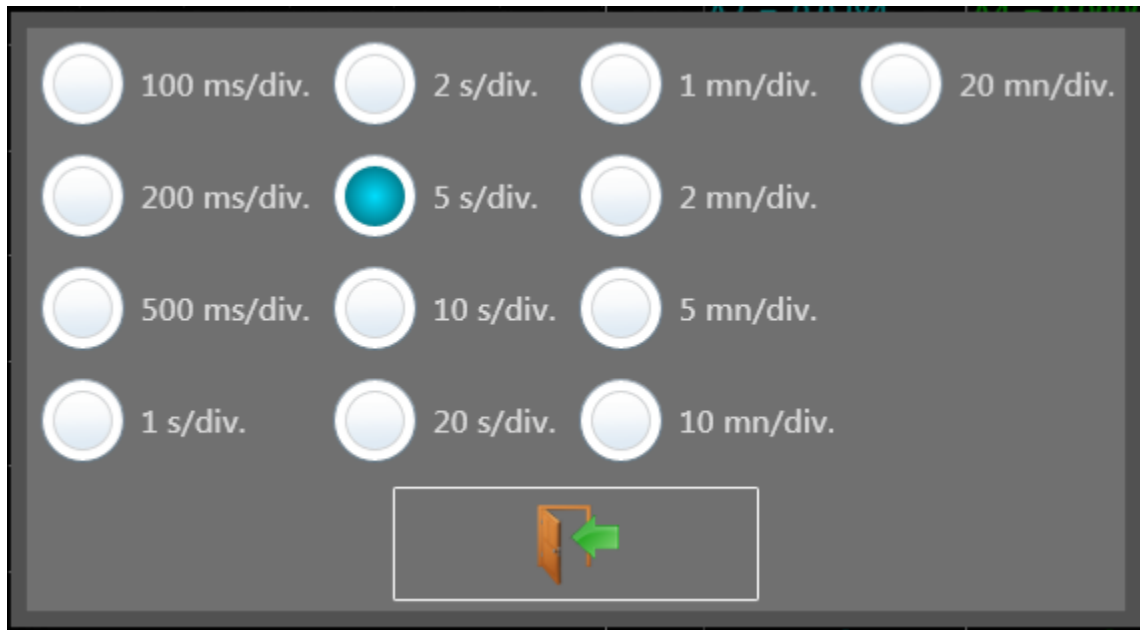
### 4.4 Math

Math functions may be applied to multiple channels. To enable math functions, enable the check-box for "Math" in the

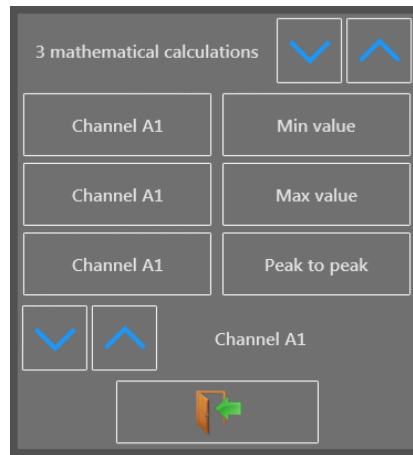
"Screen Setup" window. When enabled, the  icon is added to the right hand button panel. Pressing the button brings up the configuration dialog shown in [Figure 4.6](#). Use the arrow buttons at the top to increase or decrease the number of math functions. Use the arrows at the bottom to change the channel on which the math is done, or press the channel named for each row to set the desired channel. See [Figure 4.7](#) for the set of functions available.

The values calculated for each function configured are shown on the main plot screen, colored the same as the channel they do math on. See [Section 4.4.1](#)

Calculated values are displayed in the plot window showing the following:



**Figure 4.5** Time Base Setting (Time/Division)



**Figure 4.6** F(t) Channel Math Settings Dialog

- channel number (with its color)
- function name
- value

#### 4.4.1 Math Functions

Math function values may be moved around on the screen. To move the math values, click and drag them to a desired position on screen.

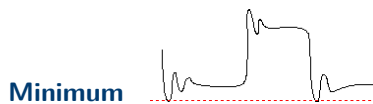




Figure 4.7 F(t) Channel Math Functions Dialog

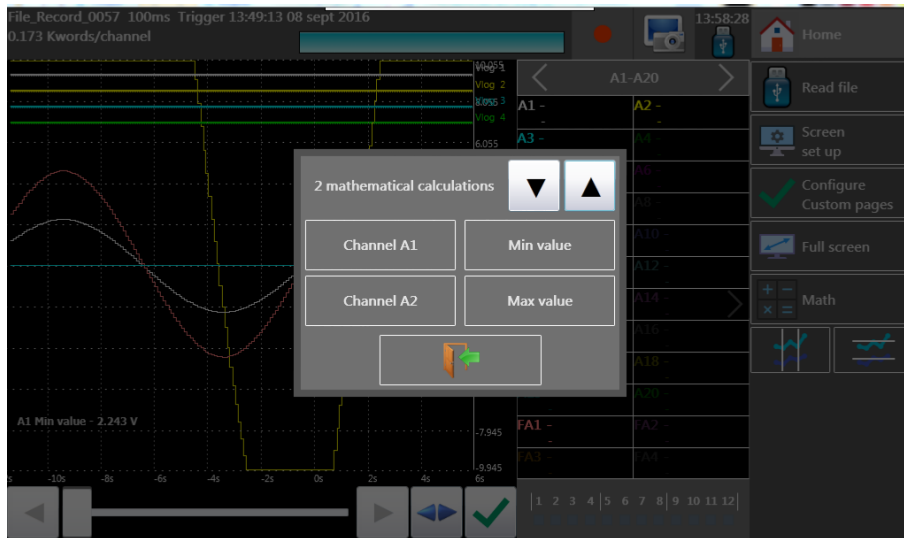
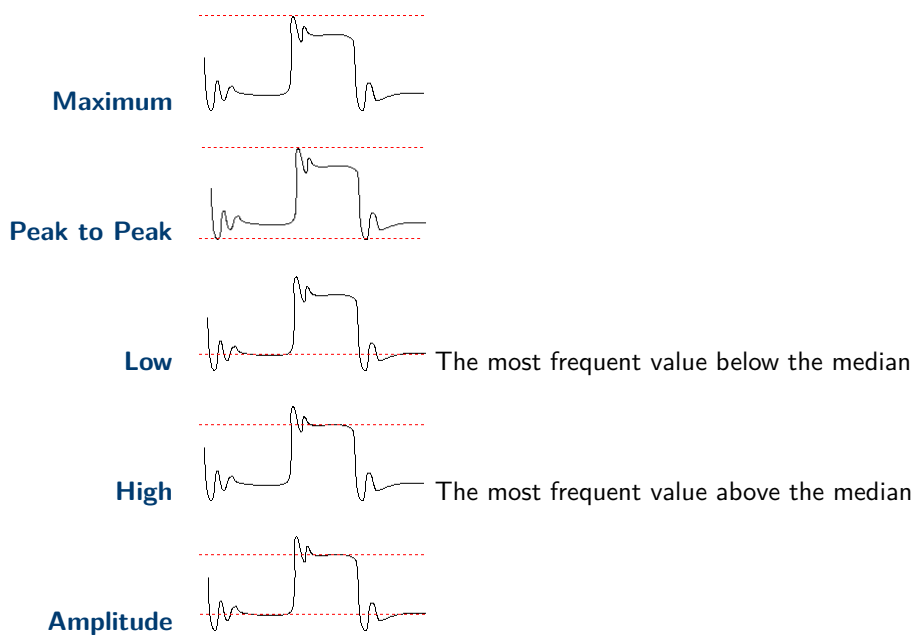
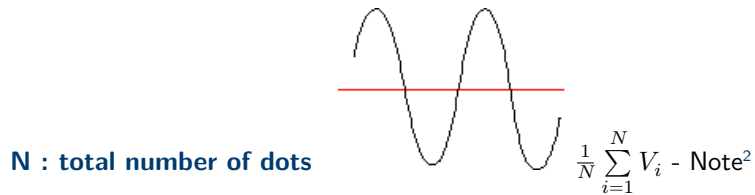
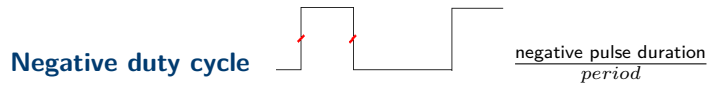
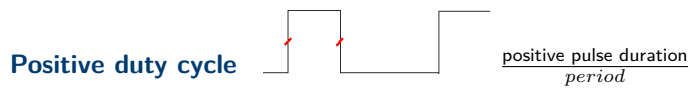
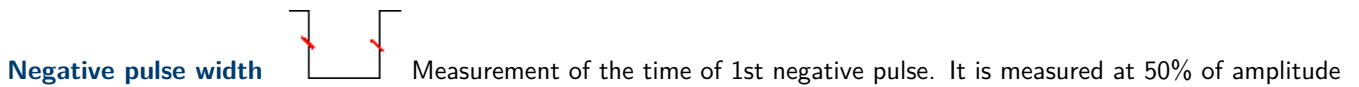
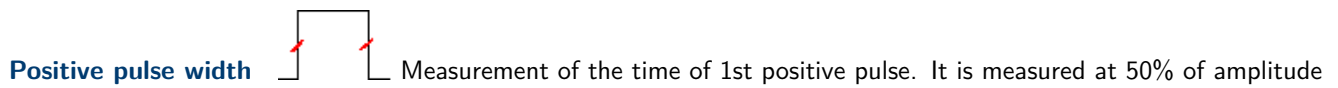
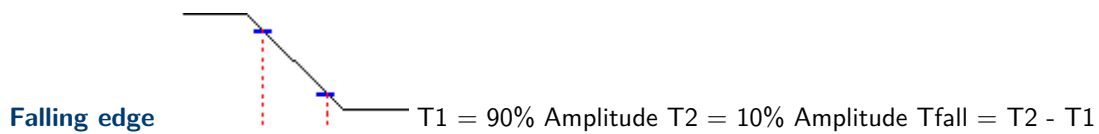
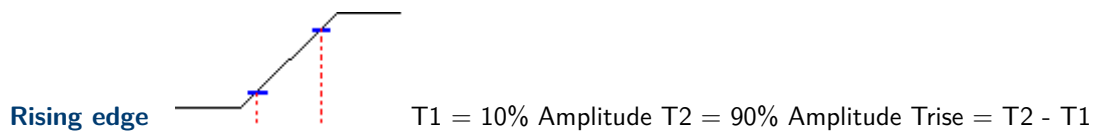
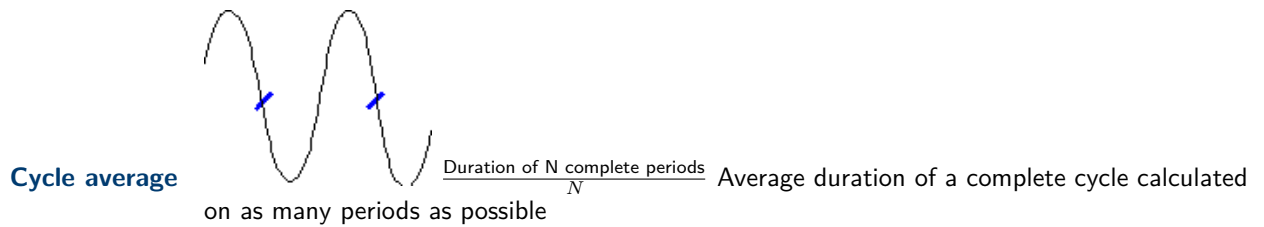
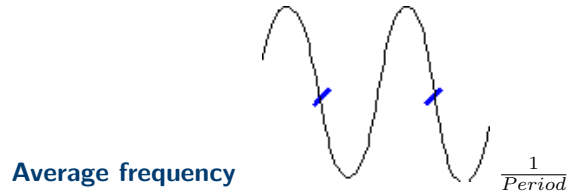
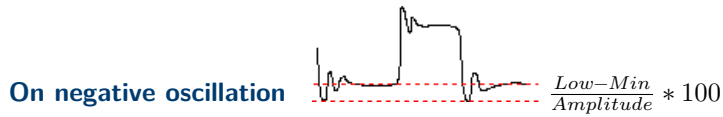
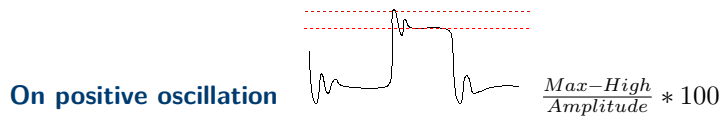


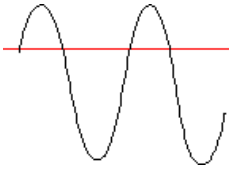
Figure 4.8 Math Dialog Box



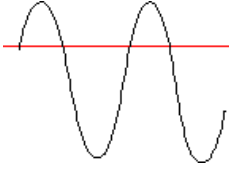


<sup>2</sup> Calculated using the whole graphic range

**RMS**


$$\sqrt{\frac{1}{N} \sum_{i=1}^N (V_i)^2} - \text{Note}^2$$

**Standard Deviation**


$$\sqrt{\frac{1}{N} \sum_{i=1}^N (V_i - \bar{V})^2} - \text{Note}^2$$

# XY Plot

The XY mode is accessible via the main menu by pressing the **XY** key. In this mode, one of the channel represents the horizontal axis (X), and the other channel the vertical axis (Y). For example, if the channel for the horizontal axis is 1V and the channel for the vertical axis is at 95F, the recorder plots a point at (1,95).

A custom background/grid may also be shown on the display. From the "Screen Setup" menu accessed by pressing the button on the XY plot screen, select the "custom grid" check-box, select the folder containing the bitmap to be used (middle button), and select the bitmap using the right most button on the line. Along with the XY plot, a numeric representation of the current signal values is shown.

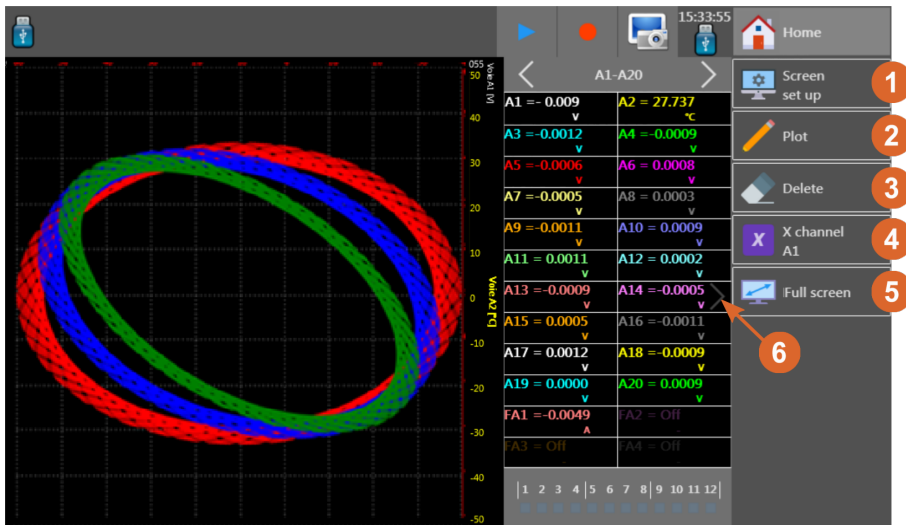



Figure 5.1 XY Display Screen

Item	Description
1	Screen configuration - Open the measurement display
2	Trace - Allows to start or stop the trace
3	Delete Allows to delete the screen
4	X channel Selects the channel for the horizontal axis
5	Full screen Allows to view on the full screen, press on the reticule to come back to the normal mode
6	Arrow  key shows or hides the numerical window

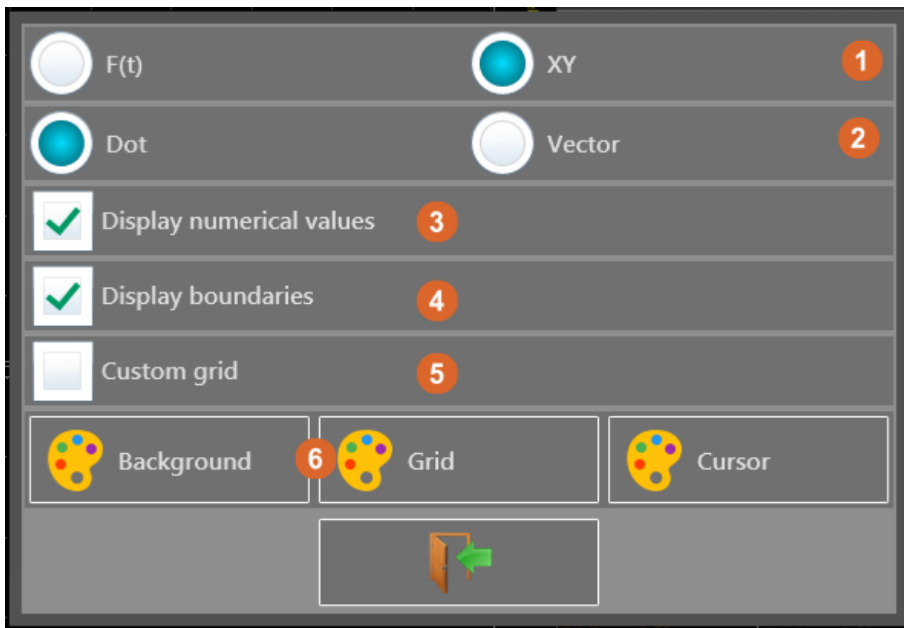




Figure 5.2 XY Setup Window

Item	Description
1	Plot type - F(t) or XY
2	Point display - Dots or vectors
3	Display Numerical Values - shows the numerical values in a table
4	Display Boundaries - shows or hides the axes
5	Custom Grid - configures the grid and background image
6	Colors - sets the color of the background, grid and cursor using a color picker





**Figure 5.3** Numerical Window

1. The  or  keys : selects the group to view.
2. By pressing a specific channel:
  - The graph terminals are bound to this channel.
  - In real time acquisition, the instant value will show up.
  - By visualizing the cursors; then the difference value between cursors as well as T1 and T2 values corresponding to cursors T1 and T2 will be displayed.
3. Press right to hide this window, and when hidden, the icon points left.

# Numeric Display

The numerical window allows to visualize in real time the values of each channel. See **Figure 6.1**. The number of channels shown per screen depends on the number of channels selected. Each display page is accessed by pressing the right and left arrows.



Item	Description
1	Cycle display screens (channels, custom sets, logic functions, etc...)
2	Digital channel state (shown when "Logic Channels" option is set in the "Channels and Functions" menu.
3	Reset minimum and maximum recorded values
4	Individual channels, click within each channel to open the configuration menu for that channel

**Figure 6.1** Numeric Display Screen

# Recording

The DAS240-BAT and DAS220-BAT can save data to internal storage. The user can then retrieve the data and review it on the unit, save it to a USB drive, or retrieve it via the Ethernet interface.

## 7.1 Create a Recording

To create recordings, press the “record” button on either the “setup” screen or from the top ribbon when in any of the 3 data display modes (F(t), XY, or Numeric) to start a recording. See **Figure 7.1**. Recording starts when the trigger condition is met. If the trigger function is not running, stop is selected on the trigger setup page, then recording starts immediately. **Figure 7.2** is waiting for a trigger, and **Figure 7.3** has started recording.



Figure 7.1 Record Keys

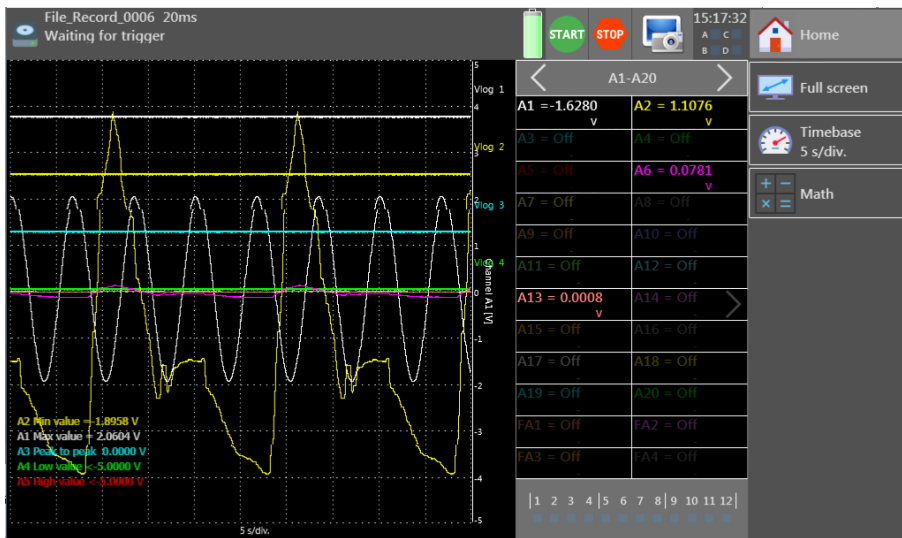
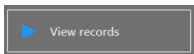


Figure 7.2 Record screen

## 7.2 View Recording

Stored recordings may be recalled and analyzed. With a recording loaded, zooming into portions of the recording and making cursor measurements can be done. To open a saved recording, navigate to the “Home” screen and press the



button. Alternatively, when in either XY or F(t) screens, the blue triangle (**Figure 7.4**) in the top ribbon opens the recording playback mode.

### 7.2.1 Loading a Recording

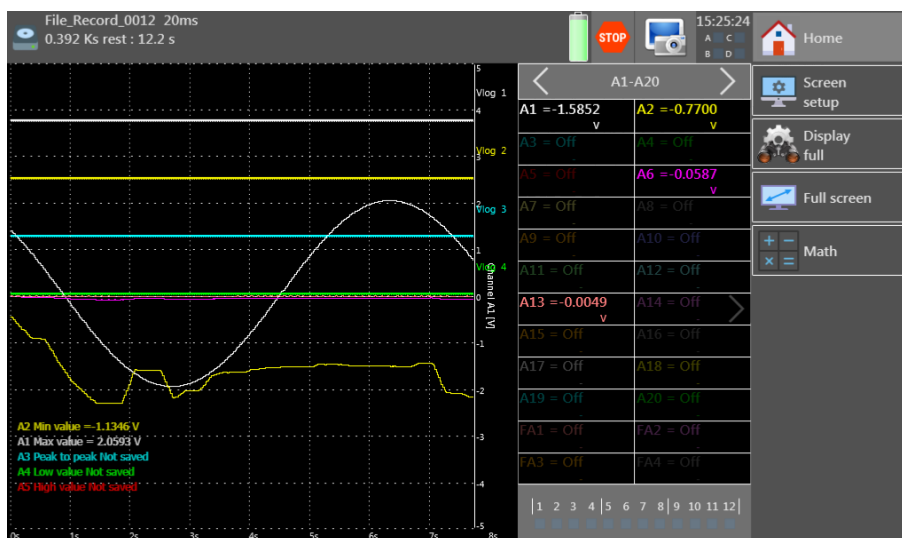


Figure 7.3 Recording started

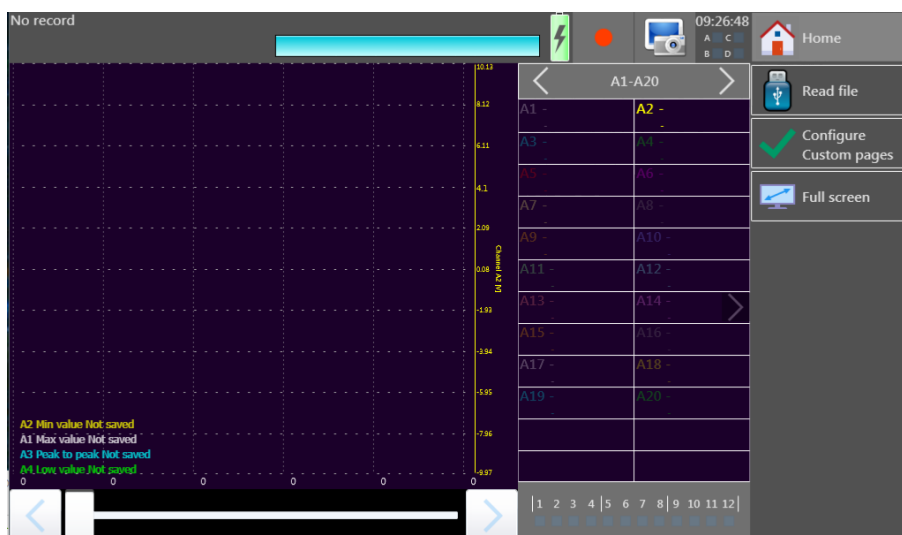
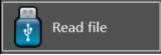



Figure 7.4 Recording playback

1. Press the  button. This will open **Figure 7.5**.
2. Press the “Read File” button within the new dialog.
3. Navigate and select the recording to view.
4. When a file is selected, a new button appears . Press this button to load the selected recording.

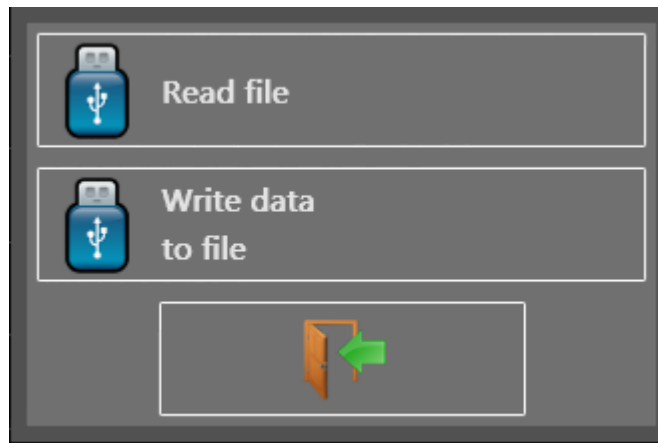


Figure 7.5 Load Saved Recording File Dialog

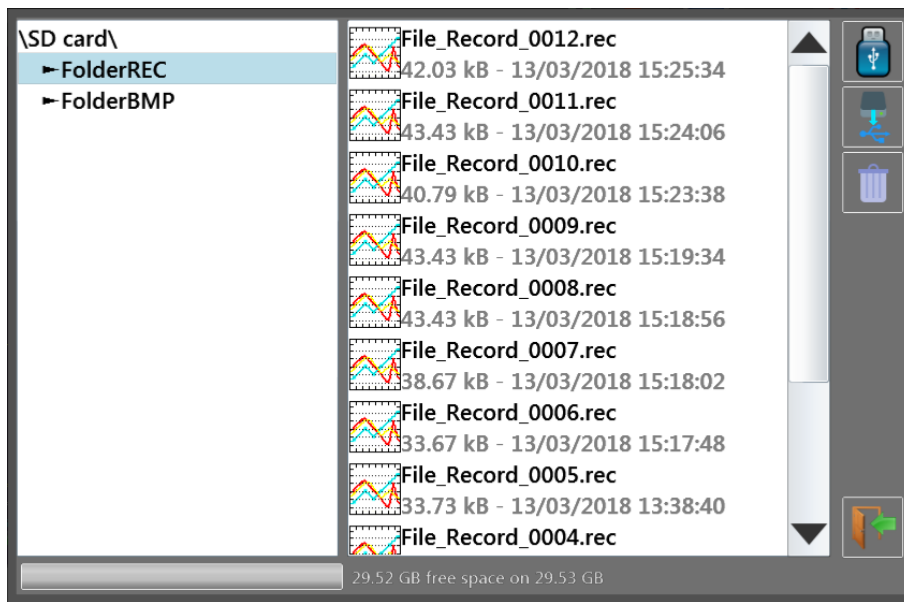


Figure 7.6 File Browser

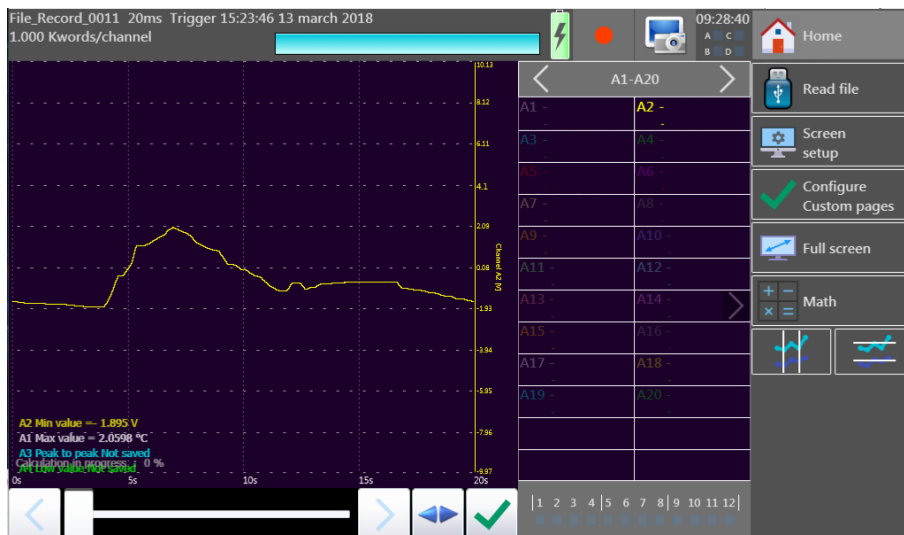
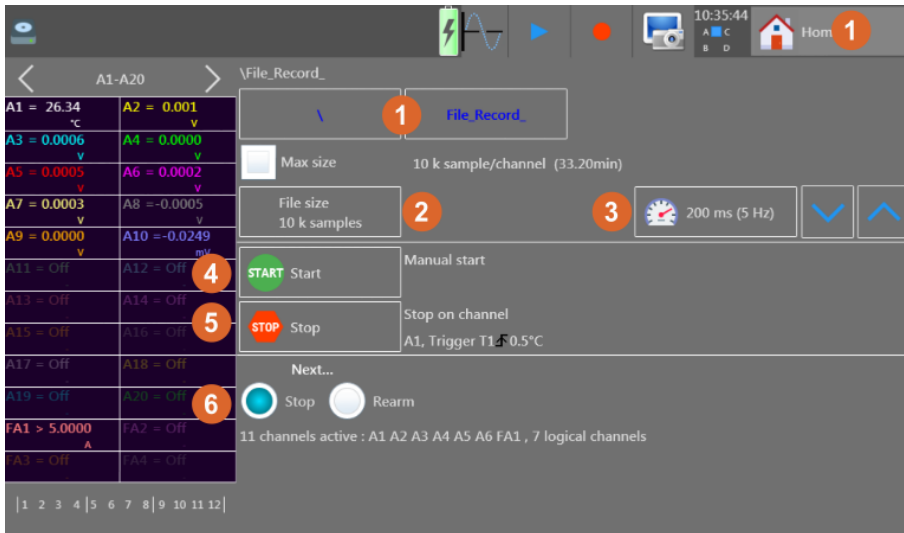


Figure 7.7 Saved Recording Loaded

# Triggering Recordings



Item	Description
1	Record file path
2	Recording size
3	Reading storage rate (reading period)
4	Start condition
5	Stop condition
6	Trigger arm state

**Figure 8.1** Trigger Menu

The start and stop functions control the conditions that initiate data recording. Opening the “Start”, or “Stop” trigger menus open the start condition dialogs with the following recording start options:

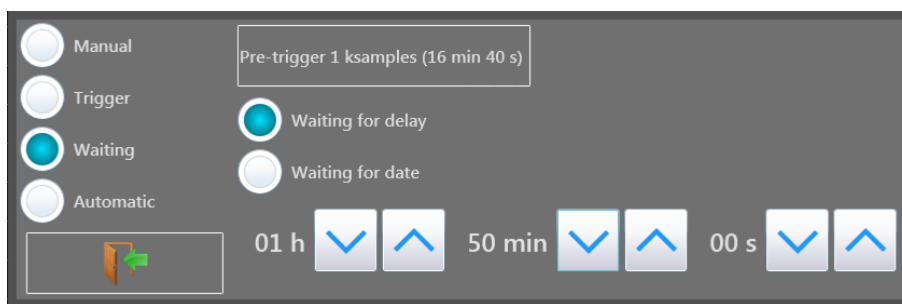
- Manual** pressing a key
- Trigger** Based on Analog, or Digital signal conditions. See [Section 8](#) for details
- Waiting** After a delay or at a specified date and hour. See [Section 8.1](#) for details
- Automatic** Occurs immediately, and automatically stops when the file is full
- Pre-Trigger** Quantity of samples to record preceding the trigger

## 8.1 Waiting Start Condition

Starting a recording at a prescribed later time or date. [Figure 8.2](#) shows the 2 dialogs for configuring each condition. Waiting on a delay, will wait for the prescribed time and proceed with a recording. Waiting for date delays recording until a specific time and date. For each, configure the time in hours, mins and seconds, and for the date, the day, month and year is also set.

## 8.2 Recordings

- Recording setup:
  - Selection the folder
  - Selection the file name (beginning of the file name, the end is an incremented numerically)
  - Length of the file (maximum or selection of the number of samples per channel)
  - Measurement data prior to a trigger event may be included in the data recording. The amount of data is defined as the “Pre-trigger” samples. The amount of data is set and determines the amount of time before the trigger event to include in the recording.
- Speed: The maximum speed is determined by the number of channels for acquisition.



Wait for a Time



Wait for a Date

**Figure 8.2** “Waiting” Start Conditions

- Start: Start condition of the data acquisition
- Stop: Stop condition of the data acquisition
  - Automatic: when the file is full
  - Trigger: on a channel or a combination of analog or logic channels
- After acquisition: action after the end of the data acquisition (only available if the Start and Stop triggers are not set to Manual)
  - Stop: no action
  - Rearm: a new file is launched waiting for the Start trigger
- View of the active channels, of the recording time, of the pre-launch

**Note:** A message “Impossible” shows up when the saving possibilities are exceeded. Fix this by reducing the sampling speed or the number of channels.

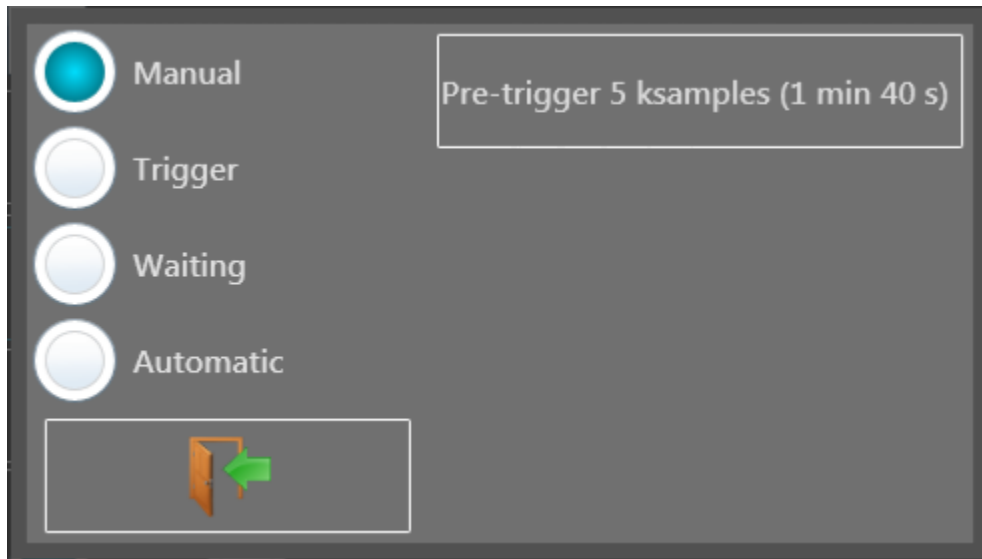
Various conditions are available for starting and stopping acquisition recording. Analog signals, time delays, and logic inputs are trigger sources. Also, the amount of data prior to a trigger event is configurable. Access the trigger menu from the “Home” screen and the “Trigger” button. **Figure 8.1** is representative of the trigger configuration window.

## 8.3 Triggering

Triggering is based either on a single channel edges and thresholds, combinations of analog channels, or set digital signal states.

### 8.3.1 Single Analog Channel Trigger

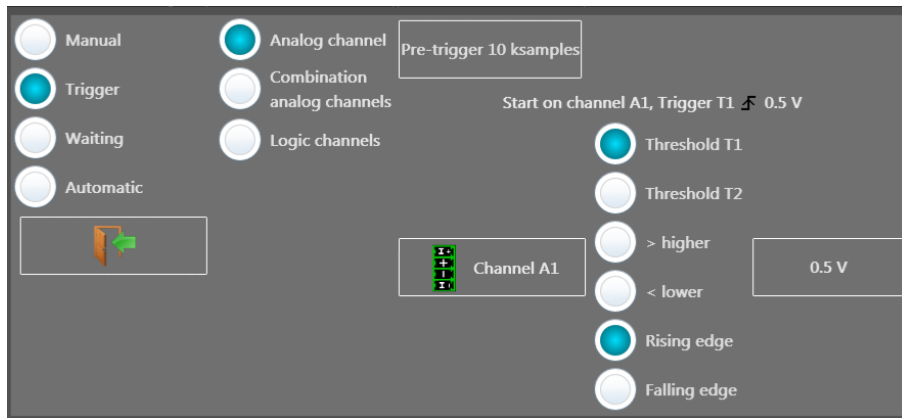
To use a single analog channel as a trigger source, the general procedure is as follows:



**Figure 8.3** Start Condition Dialog

1. Select trigger, and “Analog Channel” from the trigger dialog.
2. Set the amount of Pre-trigger samples to record.
3. Choose the trigger source channel.
4. Select the trigger condition (Threshold, level (higher/lower), or edge)
5. Set the trigger analog signal level.

### 8.3.2 Single Threshold



**Figure 8.4** Trigger Threshold Setup

**Channel:** Selection of the channel, on which the trigger threshold is applied

**Threshold 1 / Threshold 2:** Selection of the threshold to settle; each channel is tested with reference with 2 thresholds, i.e. you can program a start condition on the channel A1 and the threshold 1, and a stop condition on this same channel A1 and the threshold 2

**Higher / Lower:** Trigger when the channel value is more or less than the set threshold

**Threshold value:** Threshold value selected in real value (taking the current unit and scale of the configuration of the selected channel into account)

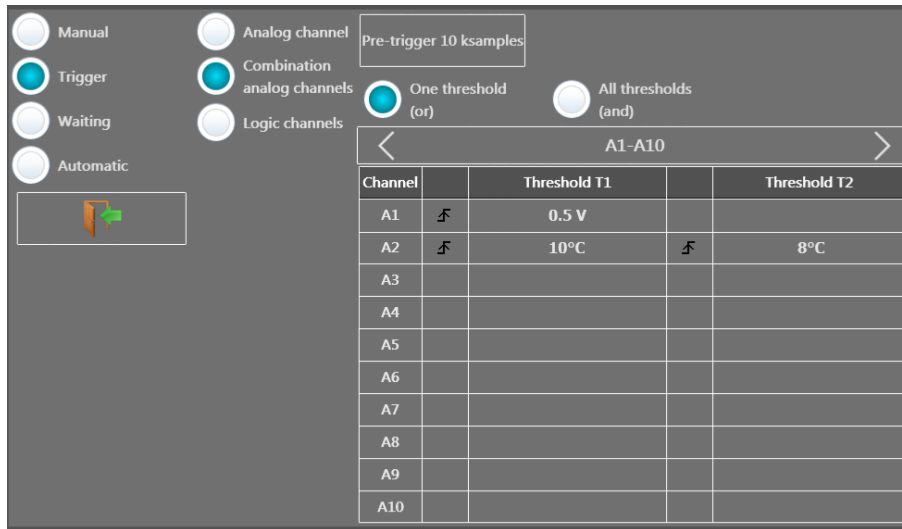


**Edge:** Selection of the active edge of the channel in reference to the threshold

**Pre-triggering (only for start):** Gives the acquisition time before the trigger appears.

### 8.3.3 Multiple Thresholds

After selection of a trigger on a set of logic channels, the window allows you to set the trigger under several conditions. Then, by pressing the various thresholds in front of their respective channels, you open the threshold parameter window.

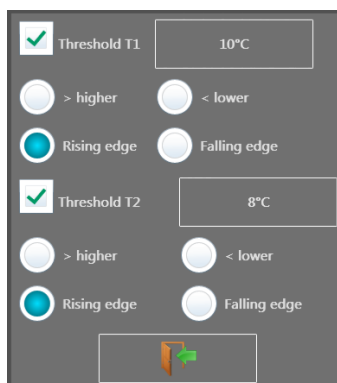


**Figure 8.5** Multiple Threshold Trigger Screen

- One of the thresholds, or the first achieved condition activates the trigger
- All thresholds, and all conditions must be simultaneously achieved to validate the trigger
- A table makes it possible to select all channels and the validity of the channels

Selecting the channel allows the selection of the thresholds:

- S1 and S2
- Value of the thresholds
- Rising / Falling edge, or Low / High value



**Figure 8.6** Trigger Type Setup Screen

### 8.3.4 Trigger Examples

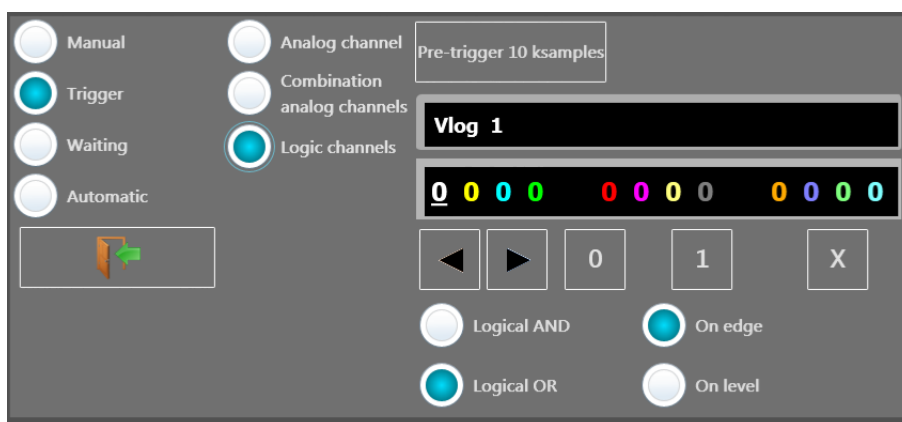
- Edge trigger: you need a change of status  
Example: Channel A1, rising edge, threshold = 0V: triggers only if the signal status changes from negative to positive
- Level trigger: no need to pass the threshold  
Example: Channel A1, high level, threshold = 0V: triggers only if the signal is positive
- Alarms only have level triggers

## 8.4 Trigger on Logic Channels

Selecting “Logic Channels” as the trigger source changes the window to show conditions for logic channel triggering. Each of the logic channels is configured as a 1, 0 or X (don’t care). Use the arrow keys to move through the logic input bits. Triggering may be configured as either an AND condition or an OR condition. This is applied to each channel. Lastly, the trigger event is generated on either a Level or Edge condition.

**Logic 1** Greater than 4.0 Volts

**Logic 0** Less than 1.6 Volts

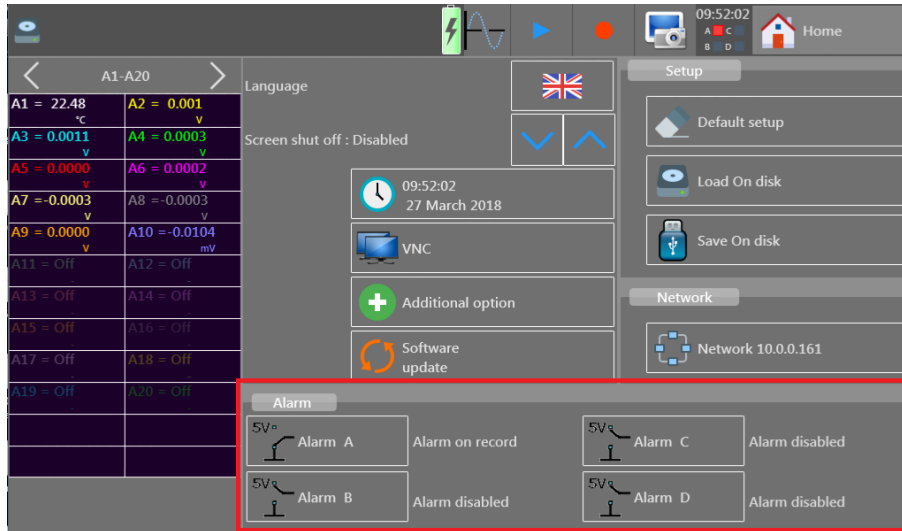


**Figure 8.7** Logic Trigger Setup Screen

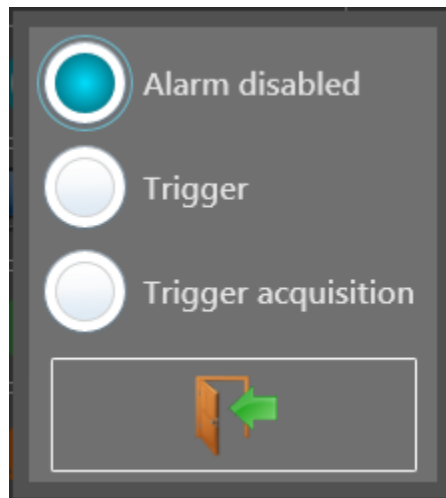
# Alarms

4 configurable alarm signals allow signaling from the recorder through the digital port. The alarm signals are high (5V) when the alarm condition is detected. The main display's alarm status section indicates the status of the alarms. The main display alarm status is "sticky" in that when alarm triggers, the field is set to active (red). See **Figure 9.3**. The condition may clear, and the alarm status will continue to show an alarm happened. The digital port clears the alarm when the programmed condition is not met any longer and returns to 0V.

To configure the alarms, open the "setup" menu from the "home" screen. See **Figure 9.1**. At the bottom of the screen are the 4 alarms. Each button opens the configuration dialog for that alarm. See **Figure 9.2**

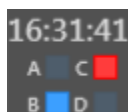


**Figure 9.1** Alarms on Setup Screen



**Figure 9.2** Alarm Dialog

## 9.1 Alarm Status



**Figure 9.3** Alarm Status

The status of all 4 alarms is always visible in the top ribbon, each with its own small square. The status of each alarm is indicated 3 colors:

- Transparent** Alarm disabled
- Blue** Alarm enabled, not triggered
- Red** Alarm enabled and triggered

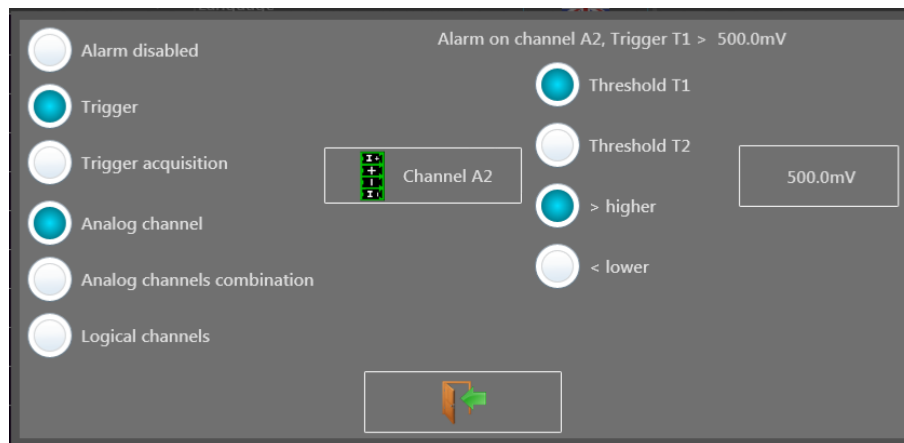
To clear an alarm, press the on screen box containing the alarm statuses.

## 9.2 Analog/Math/Timing Signal Alarm

An alarm based on analog signal levels, a math function, or a “logical function” is set by selecting the “trigger” function on the Alarm dialog (**Figure 9.2**). Signals available for Alarms must be active signals configured in the “Channels” menus on the “Home” screen.

When selected, the dialog changes contents to show something similar to **Figure 9.4**.

Select the desired signal by pressing the button listing a channel at the center of the dialog box. Depending on the signal type, 1 thresholds may be set. The selected threshold is show at the top of the dialog. To set the trigger as a window, the “channels combination” configuration must be used. See **Section 9.3**.



**Figure 9.4** Analog Alarm Trigger



**Figure 9.5** Alarm Analog Thresholds

## 9.3 Analog Signal Combination Alarm

More complex triggering based on windows, and combinations of signals is available. The signals are limited to the analog channels and do not include math and timing as in the single channel alarm. The signals may have 2 thresholds.

The set of signals configured will trigger the alarm if 1 threshold is true, or all thresholds are true. This is set by the AND/OR condition at the top of the dialog.

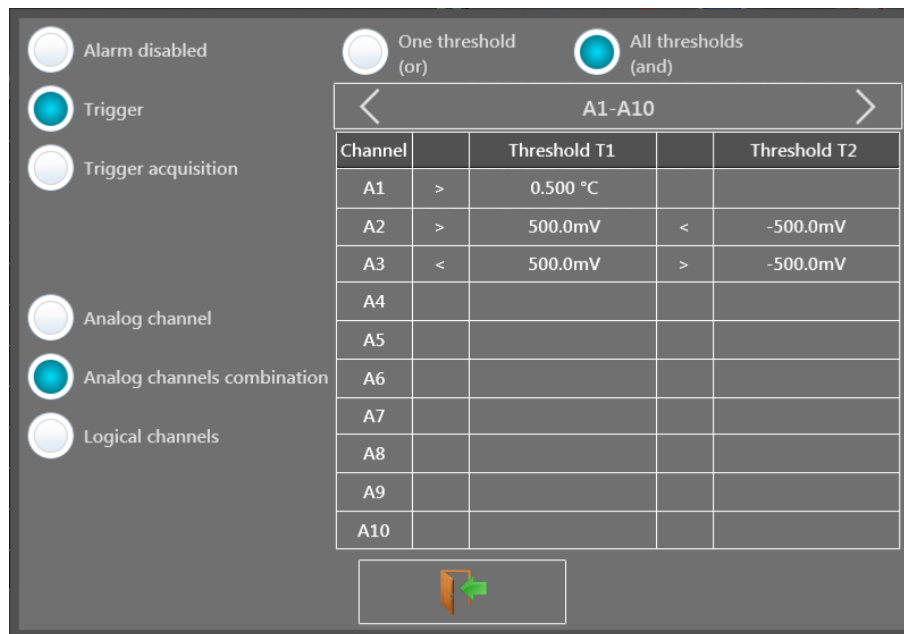


Figure 9.6 Analog Combination Trigger

### 9.4 Logic (Digital) Signal Alarm Trigger

An alarm based on the logic state of the digital input is configured by selecting the “Logical Channels” option. Following the typical convention of a 1, 0 and X to denote true, false and “dont’t care” respectively, is used to set the digital patten to trigger on. Also, using the “AND” or “OR” conditions select when the trigger occurs. With the “AND” condition, all signals defined must be true for the Alarm to trigger. In the “OR” case, any valid signal, excluding the “X” signals will trigger an alarm.

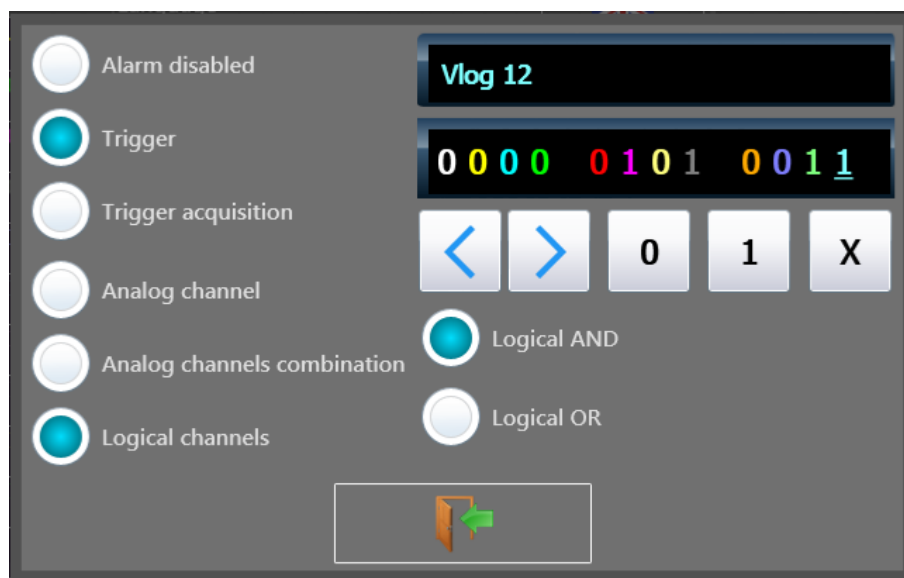


Figure 9.7 Digital Trigger

## 9.5 Alarm on Recording Start (Trigger Acquisition)

An alarm is also available for signaling the start of a recording. Select the “Trigger Acquisition” option to enable this type of alarm.



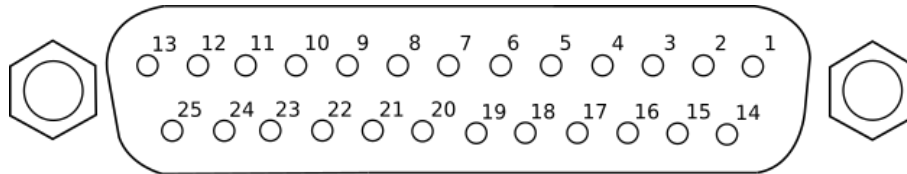
**Figure 9.8** Trigger on Alarm

# Logic Channels

Up to 12 logic channels can be recorded simultaneously with the analog channels. In addition, 4 timing channels are also available for measuring duty cycle, RPM, and pulse count.

## 10.1 Logic Input Connector

This is a DB-25 connector located on the top of the unit.



Pin	Signal	Pin	Signal
13	Logic Ch 1	19	Function K2
25	Logic Ch 2	6	Function K3
12	Logic Ch 3	18	Function K4
24	Logic Ch 4	5	Ground
11	Logic Ch 5	17	Ground
23	Logic Ch 6	4	Ground
10	Logic Ch 7	16	9-15V 0.2A
22	Logic Ch 8	3	Ground
9	Logic Ch 9	15	Alarm C
21	Logic Ch 10	2	Alarm D
8	Logic Ch 11	14	Alarm A
20	Logic Ch 12	1	Alarm B
7	Function K1		

**Figure 10.1** Logic Connector

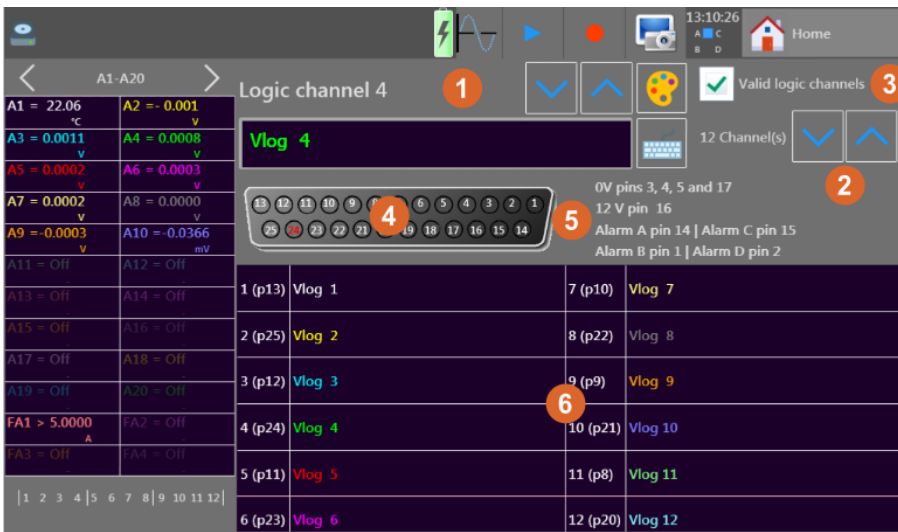
## 10.2 Logic Channel Setup

To set the logic channels, press the “logic channels” button on the “Home” screen, or from the “F(t)” screen, click within the logic signal portion of the screen when present, See **Figure 10.2**. The configuration screen will open and resemble **Figure 10.3**.

The set of channels depends on the number of channels chosen. For a given number of channels, the signals enabled on the connector is fixed. For example, if 4 channels are enabled by the up/down arrows beside the text listing the number of channels, then pins 13, 25, 12, and 24, will be active. They become channels 1-4 respectively.



**Figure 10.2** Logic Channels on the F(t) screen

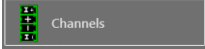


Item	Description
1	Channel number, color and arrows to change channel
2	Channel count
3	Enable logic channels
4	Connector (red - selected channel)
5	Additional pin information
6	Channel #, pin, and state (dim - disabled)

Figure 10.3 Logic Channel Configuration Screen

### 10.3 Timing

Function channels K1-4 are used for measuring the PWM duty cycle, count, or frequency of up to 4 digital signals. They are also 3.3V level signals and tolerant of 24V.

Access the setup for these functions from the “Home” screen and pressing the  Channels. Then navigate to the channels K1-4. See [Figure 10.4](#). To configure each channel, either change the parameters on this screen by opening the menus per field in the table, or open the configuration screen for a single channel by pressing the channel ID (i.e. K1). Configuration of a single channel is done via screens similar to [Figure 10.5](#).

	K1	K2	K3	K4	A5	A6	A7	A8	A9	A10	
Name	Channel K1	Channel K2	Channel K3	Channel K4							Name
Type	Frequency	Counter	PWM	Frequency							Type
Filter											Filter
Samp. Period											Samp. Period
Function	Disabled	Disabled	Disabled	Disabled							Function
Range	10 Hz	1000	100 %	10 Hz							Range
Center zero	0 Hz	0	0 %	0 Hz							Center zero
Max.	10 Hz	1000	100 %	10 Hz							Max.
Min.	0 Hz	0	0 %	0 Hz							Min.
Threshold T1	0.5 Hz	0.5	0.5 %	0.5 Hz							Threshold T1
Threshold T2	10 Hz	-0.5	-0.5 %	-0.5 Hz							Threshold T2

Figure 10.4 Timing Function Channels

### 10.4 Alarm Outputs

Finally, the “Alarm” signals are also present on the Logic connector (A, B, C and D. Pins 14, 1, 15 and 2 respectively). Their setup and use is described in [Section 9](#). All outputs are TTL 5V. When the unit is powered off, outputs have a 5kΩ resistance.



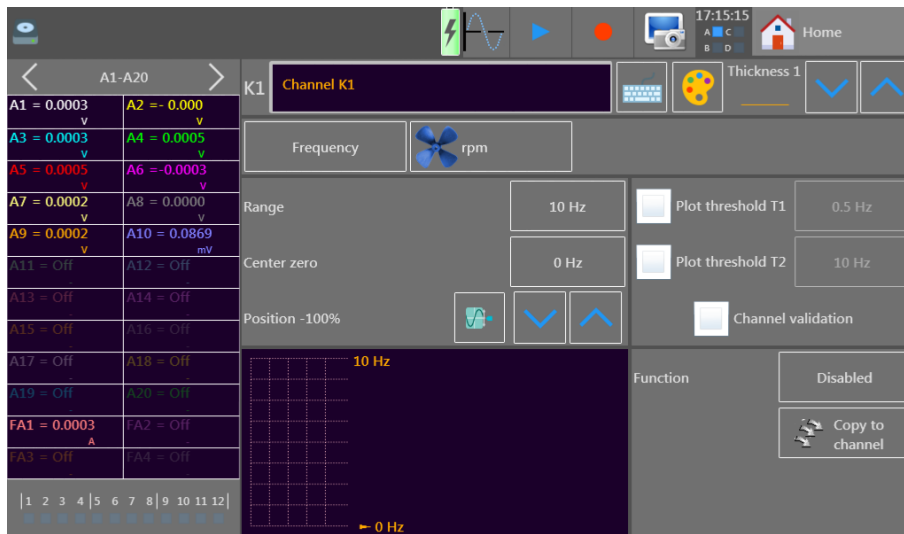


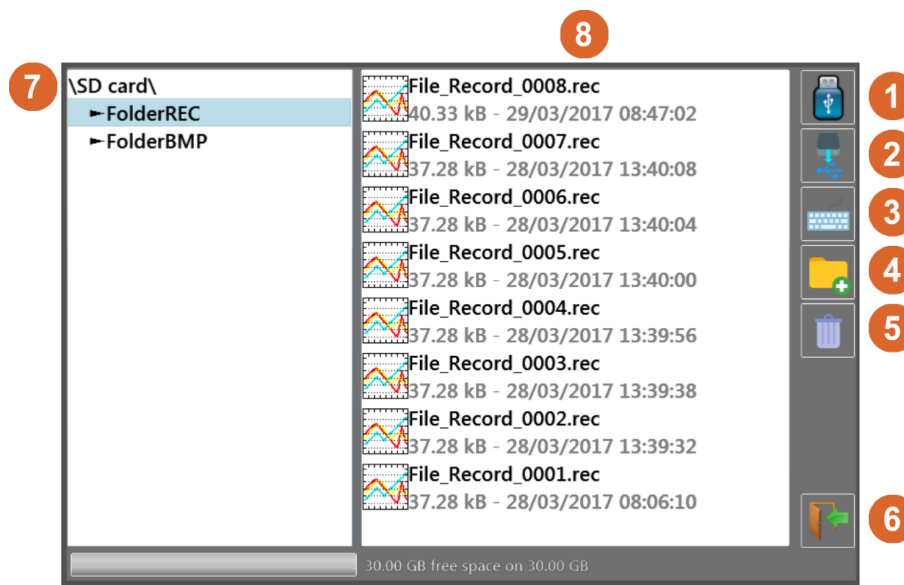
Figure 10.5 Single Timing Function Setup Screen

# File Management

The recorder is capable of creating recordings, screenshots, and saving device setup configurations. All of these are stored as files, “\*.rec” for recordings, “\*.bmp” for screenshots, and “\*.cfg” files for configurations. The file view dialog **Figure 11.1** is accessible from the “Home>Setup”, “(Waveform)>Screen Setup>Background”, “Home>View Records”, “Home>Setup>Load/Save on Disk” screens for example. Each instance of the file dialog allow interaction between internal and external (USB) storage. Finally, folder navigation and creation is also available.

## 1 Note:

It is highly advisable to work in a folder and not at the root of the flash disk. When erasing a folder, all files in this directory will be erased too.



**Figure 11.1** File View Screen

1. Read/write to internal flash disk or USB stick (if it was connected during unit startup)
2. Copy the selected file or folder to a USB drive
3. Create and name a new file
4. Create a new folder
5. Delete the selected folder or file
6. Close the window
7. Folder navigation and location window
8. File view and selection window

## 11.1 Setup Files

Setup configurations are loaded and saved from the “Home>Setup” menu. The configuration may be changed via the 3 buttons in the upper righthand corner of the screen:

**Default** Sets up the appliance in standard configuration

**Load from disk** Loads a configuration from a file in the internal flash disk or an USB stick

**Save to disk** Saves a configuration into a file in the internal flash disk or an USB stick

These commands are only available when the data recording is stopped.

### 11.1.1 Default

This action loads the system defaults as programmed into the unit during manufacturing.

### 11.1.2 Save Setup Files

To save a configuration, press the



. The name of the file with the alphanumeric keyboard displayed

on screen, or, if attached, a USB keyboard.

### 11.1.3 Load Setup Files

To load a configuration, press the



. Select the directory and then the file to load, and click "Load".

## 11.2 Recordings Files

Saved recordings are transferable between internal storage and USB. Recordings are saved to internal storage. See **Chapter 7** for details.

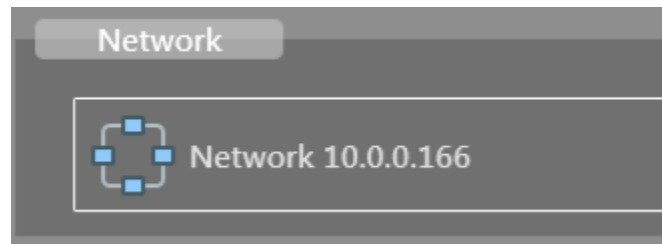
# Remote Interfaces

## 12.1 LAN Interface

The LAN connection to the DAS240-BAT supports ModBus, VNC, Sefram Viewer and DAS Lab. Sefram Viewer and DAS Lab are tools provided by B&K/Sefram, and are available as a single download from <http://www.bkprecision.com>. The LAN connection supports 10mBit and 100mBit networks. In the case where a network is not available, using a crossover cable is also possible.

### 12.1.1 LAN Setup

Setup of the LAN interface is available by clicking the “Network” button on the “Home” screen. (See **Figure 12.1**). Clicking the “Network” button opens the network setup dialog (See **Figure 12.2**). The LAN interface supports static and dynamic (DHCP) configuration. For DHCP, the DHCP checkbox is marked, and the network address will be shown on the “Network” button shown on the “Home” screen. For static IP configuration, using parameters defined for the network (see your local network administrator for details) are set in the dialog.



**Figure 12.1** LAN Configuration Button

## 12.2 VNC

Use of the unit from another computer is available using VNC (Virtual Network Computing). This presents an interactive view of the front panel allowing nearly all functions to be used remotely. Numerous software tools are available for using VNC (ex. UltraVNC).

To open a connection, the IP address of the unit is required. This is found on the “Network” button on the “Setup” screen.

### 12.2.1 Changing the Password

Open the “Setup” screen and press the “VNC” button. The resulting dialog box shows the current password. Press the keyboard icon in order to change the password.

## 12.3 Network File Transfer

Transfer your files to your computer to save them or view them with the SeframViewer software.

- Using of the Windows file explorer
- Filezilla: freeware (<https://filezilla-project.org/>)
- Using an external browser (Firefox, Chrome, Edge, etc...)

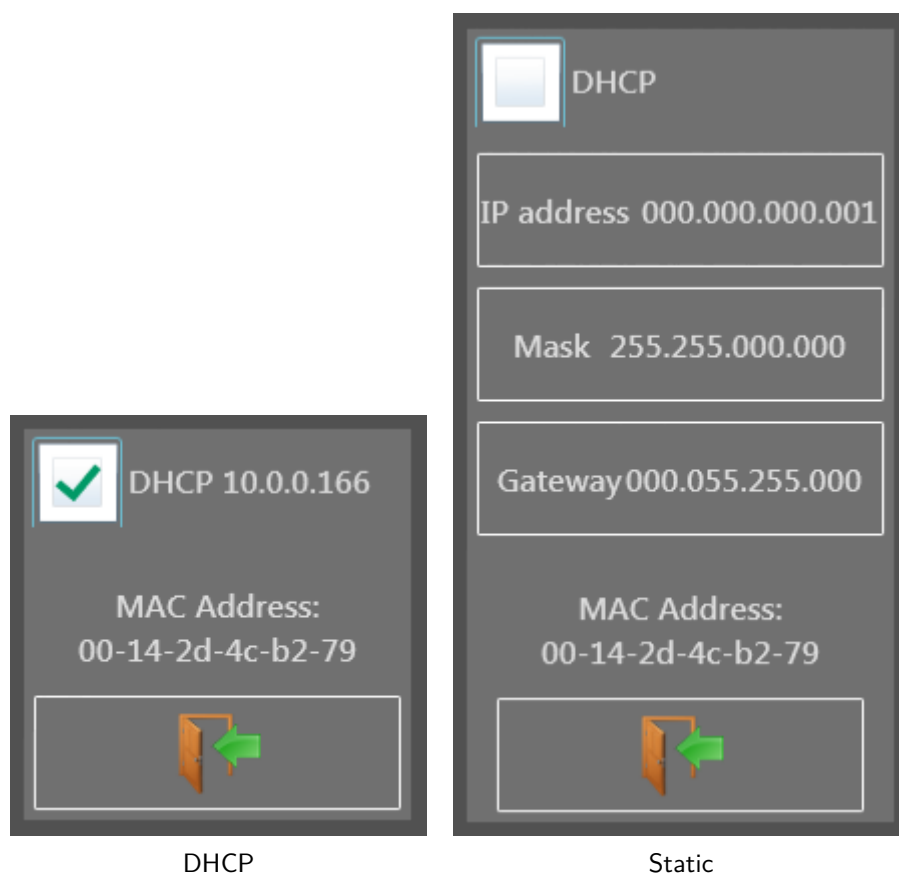


Figure 12.2 LAN Setup

## 12.4 Viewing with SeframViewer

You can transfer the data acquisition files to a PC computer for viewing.

The SeframViewer software is provided on a CD-ROM with the appliance. You can use it to view the recorded files or convert it into xls or txt files.

It works under WINDOWS with Framework 2.0.

Transfer of the files from the appliance to the PC computer:

- USB peripheral device
- with the FTP protocol

Launch the SeframViewer software (or double-click on a file)

Open a data acquisition file (suffix .rec)

You can select:

- the channels to display
- the display mode f(t) or xy
- the self-calibration of the channels.

Your data acquisition file shows up on screen. The functions of SeframViewer are available.

Refer to the instruction manual included in the software to discover all available functions in SeframViewer by clicking on the last icon < Help >.

You can also directly create a file (.txt or .xls) by launching the command mode of Windows with the following line (see the Options sub-menu of the help):

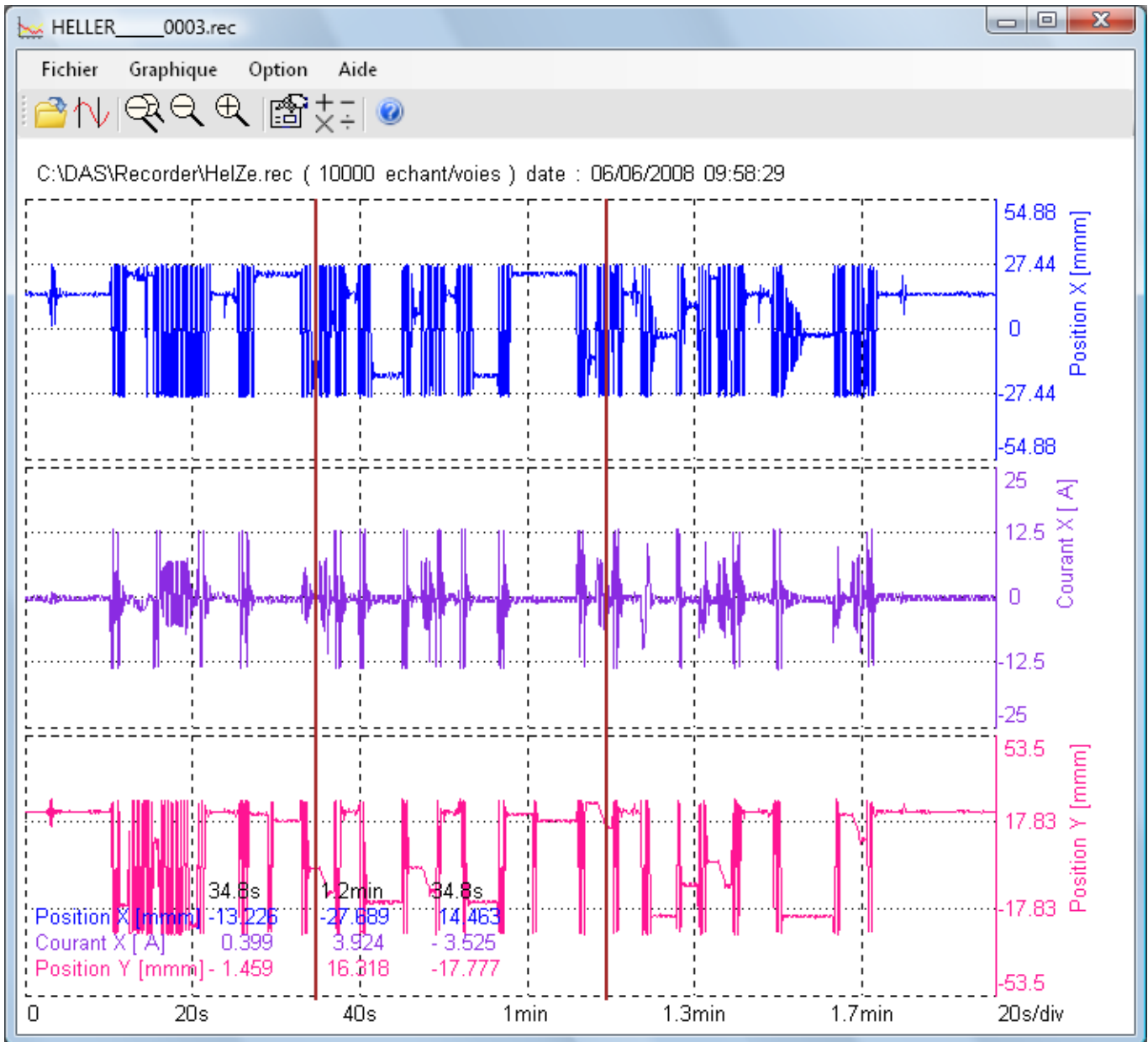


Figure 12.3 Sefram Viewer

### 12.4.1 Example

C:\Program Files (x86)\SeframViewer\sframviewer.exe myfile.rec /x  
will create a .xls file

C:\Program Files (x86)\SeframViewer\sframviewer.exe myfile.rec /t  
will create a .txt file

Excel@export will directly launch Excel in the browser.



Figure 12.4 Excel Export

## 12.5 Device Control with DASLab

The DASLaB software manages configurations of your DAS240-BAT device.

- Open, modify and save your configurations
- Manage configurations remotely using network via Ethernet or WiFi
- Download your record files using network via Ethernet or WiFi

According to your needs, click on the right button. If you want manage your DAS240-BAT or DAS220-BAT using network, enter the IP address to establish the connection.

For every action, including opening, saving, sending or refreshing configurations, the left sliding menu makes you able to apply it.

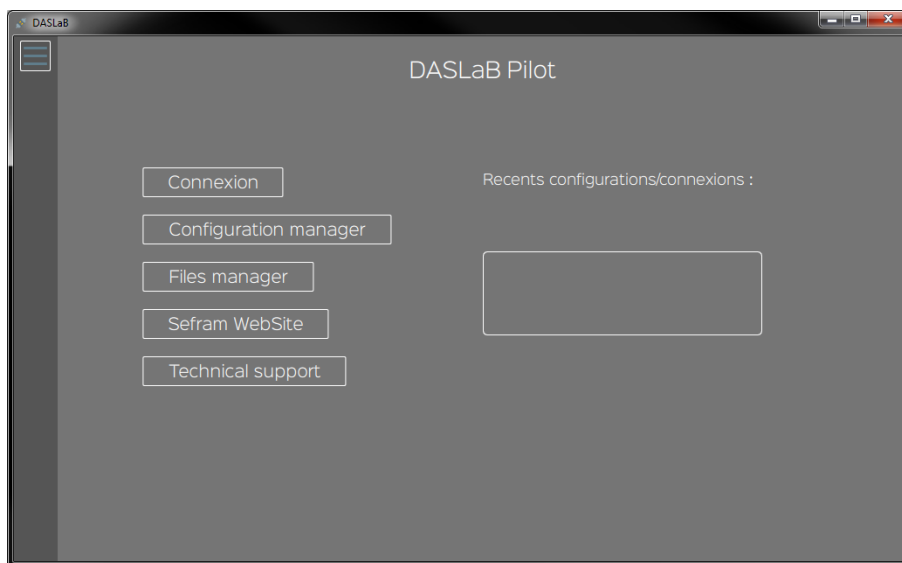


Figure 12.5 DASLab

Description	CH	Channel name	Valid	Type	Filter	Range	Zero	P
analog								
Array of channels	A1	Voie A1	<input checked="" type="checkbox"/>	Voltage	<input type="checkbox"/> 1.00 Hz	10 v	0 v	
Setup channels	A2	Voie A2	<input type="checkbox"/>	Voltage	<input type="checkbox"/> 1.00 Hz	10 v	0 v	
Trigger	A3	Voie A3	<input type="checkbox"/>	Voltage	<input type="checkbox"/> 1.00 Hz	10 v	0 v	
Setup screen	A4	Voie A4	<input type="checkbox"/>	Voltage	<input type="checkbox"/> 1.00 Hz	10 v	0 v	
Files manager	A5	Voie A5	<input type="checkbox"/>	Voltage	<input type="checkbox"/> 1.00 Hz	10 v	0 v	
	A6	Voie A6	<input type="checkbox"/>	Voltage	<input type="checkbox"/> 1.00 Hz	10 v	0 v	
	A7	Voie A7	<input type="checkbox"/>	Voltage	<input type="checkbox"/> 1.00 Hz	10 v	0 v	
	A8	Voie A8	<input type="checkbox"/>	Voltage	<input type="checkbox"/> 1.00 Hz	10 v	0 v	
	A9	Voie A9	<input type="checkbox"/>	Voltage	<input type="checkbox"/> 1.00 Hz	10 v	0 v	
	A10	Voie A10	<input type="checkbox"/>	Voltage	<input type="checkbox"/> 1.00 Hz	10 v	0 v	
	A11	Voie A11	<input type="checkbox"/>	Voltage	<input type="checkbox"/> 1.00 Hz	10 v	0 v	

Figure 12.6 DASLab

## 12.6 Modbus (slave)

Modbus is a non-proprietary communication protocol. All Modbus frames are encapsulated into Ethernet frames: it is called Modbus over TCP/IP.

That protocol is dialog based (question-answer) : the client (master) send a command, and then the server (slave), send back wanted data.

The DAS240-BAT/DAS220-BAT includes a Modbus TCP Slave service.

### 12.6.1 Setup Modbus Slave

The Modbus protocol uses ethernet network. So you have to choose the port used for that feature, and then enable the Modbus TCP server.

Default port for Modbus TCP is 502.

It is possible to use Wifi provided a USB Wifi adapter is installed and working: for performance reasons however, the wired USB interface should be used when using Modbus.

In the Setup page of your instrument, then Additional option, select the “Modbus TCP Server” button.

You could enable or disable the server: click on the radio button < Modbus server state >.

According to your preferences, you are able to change the network port dedicated to the Modbus server. To carry out that change to a successful conclusion, you must disable the Modbus server, change the port (502 by default), and then restart the Modbus server.

### 12.6.2 Mapping Modbus TCP

The instrument shares acquisition data at input registers (0x04) and discrete input (0x02).

#### 12.6.2.1 Analog Data

Acquisition data for the 200 analogs channels, and 4 logical functions channels (K1 to K4) are located in inputs registers from the following address : 0x08.

Register	Register Description
0x08	A1 High word
0x09	A1 Low word
0x0A	A2 High word
0x0B	A2 Low word
...	...
0x19F	K4 High word (channel n* 204)
0x1A0	K4 Low word

**Table 12.1** Modbus register map

An input register contains 16 bits, and each channel value is represented as a float (32 bits).

So, to read one channel, you should read two input registers.

Example : Input A1 from address 0x08 to 0x09

At address 0x08 : -16460 (16 bits)

At address 0x09 : 28160 (16 bits)

Value in float : -1.40961 (32 bits)

#### 12.6.2.2 Logical Data

Logical values about the 12 logical channels are located in the discrete inputs from the address 0x08.



Register	Register Data
0x08	DI1
...	...
0x14	DI12

**Table 12.2** Register Mapping

# Maintenance

Unplug the unit before any cleaning or maintenance.

Periodically clean the recorder while unplugged, in the following ways:

- Use water and soap to clean the front and rear surfaces.
- Never use any product that contains petroleum by-products, benzene or alcohol: damage the screen printings may occur
- Wipe with a soft lint-free cloth.
- Use an antistatic product to clean the screen.

---

## 13.1 Updating the Internal Software

---

The internal software is updated regularly with the latest evolutions. These updates are available on our website. <http://www.sefram.com/en/software-updates.html>

- To update the software, copy the file that will be provided on an USB stick. Place it on the USB connector on the rear side of the unit.
- Press the “Setup” key.
- Then press the “Software update” key to enter the update.
- Finally, to run the update, press the “Software update” key.
- Then, the internal software automatically copies the necessary files to the new version.
- Turn the unit off and on after the end of the updating process.

# Specifications

Note: All specifications apply to the unit after:

1. A temperature stabilization time of 15 minutes over an ambient temperature range of  $23\text{ }^{\circ}\text{C} \pm 5\text{ }^{\circ}\text{C}$ .
2. Short correction operation performed before making measurement.

Specifications are subject to change without notice.

## Specifications

Analog Channels		
Analog Input Channels	20 standard, expandable to 200 with optional 20-channel modules	
DC Voltage		
Ranges	± (0.5, 1, 2.5, 5, 10, 25, 50, 100) mV ± (0.5, 1, 2.5, 5, 10, 25, 50, 100) V	
Maximum input Voltage	100 V DC	
Accuracy	0.1% of the full scale ±10 µV	
Temperature with Thermocouples		
Sensors Range by Type (Cold junction compensation: ±0.5 °C)	J	-210 °C to 1200 °C
	K	-250 °C to 1370 °C
	T	-200 °C to 400 °C
	S	-50 °C to 1760 °C
	B	200 °C to 1820 °C
	E	-250 °C to 1000 °C
	N	-250 °C to 1300 °C
	C	0 °C to 2320 °C
L	-200 °C to 900 °C	
Temperature with Pt100 and Pt1000		
Current	1 mA (Pt100), 100 µA (Pt1000)	
Range	-200 °C to 850 °C	
Measurements	2 and 3 wires	
Accuracy (at 20 °C)	0.3 °C ±0.1% of reading	
Compensated Resistance	2 wires	30 Ω max.
	3 wires	50 Ω max.
Resistance		
Ranges	1 kΩ and 10 kΩ	
Accuracy	1 Ω (range 1 kΩ) and 10 Ω (range 10 kΩ)	
Logic Channels		
Logic Input/Output		
Number of Channels	12	
Maximum Permitted Voltage	24 V Cat I	
Input Impedance	4.7 kΩ	
Sampling Rate	1 ms max.	
Timing Input		
Number of Channels	4 (K1 to K4)	
Maximum Permitted Voltage	24 V Cat I	
Input impedance	4.7 kΩ	
Sampling Rate	1 ms max.	
Pulse Counter	0 to 10 Million, accuracy 0.1%	
Frequency Measurement	1 Hz to 10 kHz, accuracy 0.1%	
PWM Measurement	100 Hz to 2 kHz, accuracy 0.1%	
Alarm Output		
Number of Channels	4 Alarms (A B C D)	

Acquisition System		
Resolution	16 bit	
Acquisition System	Scan, one sample per channel	
Sampling Interval	V >50 mV	1 ms to 20 min
	V ≤50 mV, thermocouples and Pt100 / Pt1000	2 ms to 20 min
Trigger	Date, delay, threshold, combination of thresholds (and/or), word on logic channels (and, or, slope, level)	
Pre-trigger	Variable from 0 to 100k samples	
General		
Internal Flash Drive Size	32 GB	
Maximum File Size	2 GB	
Operating Temperature	0 °C to 40 °C, 80% RH (no condensation)	
Storage Temperature	-20 °C to 60 °C	
Display	10" TFT touchscreen LCD, backlit, 1024 x 600 dots	
Power Supply	15 V / 4 A max with main adapter (100 / 240 VAC)	
Interfaces	2 x USB host, LAN (10/100 base-T with RJ45 socket)	
Battery (-BAT)	Non removable, Lithium-ion	
Typical Battery Life (-BAT)	15 hours with standby mode, 10 hours without stand-by mode	
Safety	Cat I 100 V, according to IEC61010-1	
Weight	DAS240 / 3.3 lbs (1.5 kg)	
	DAS240-BAT / 4.5 lbs (2 kg)	
Dimensions (W x H x D)	2.6" x 11.7" x 6.9" (66 x 298 x 176 mm)	
Warranty	Two Years	
Supplied Accessories	Main adapter 100 / 240 V, 25 pin male connector <sup>(1)</sup> and backshell, 1 cable (70 cm) for measurement module connection, 1 measurement module (20 channels) with input terminals, stylus, soft wipe, screwdriver, calibration certificate and test report	
Order Information for Optional Accessories		
902401000	20-channel analog module with 20 input terminal blocks	
902401050	Analog input terminal blocks 20 pack	
902408000	Rugged carrying case	
902407000	Logic channels patch cord	
902406500	4 to 20 mA / 50 Ω shunt	
902409000	19" rack-mount kit	

<sup>(1)</sup> User configurable with solder cups

## Specifications

Note: All specifications apply to the unit after a temperature stabilization time of 30 minutes over an ambient temperature range of 23 °C ± 5 °C.

Analog Channels		
Analog Input Channels	10 integrated channels	
<b>DC Voltage</b>		
Ranges	± (0.5, 1, 2.5, 5, 10, 25, 50, 100) mV ± (0.5, 1, 2.5, 5, 10, 25, 50, 100) V	
Maximum input Voltage	100 V DC	
Accuracy	0.1% of the full scale ±10 µV	
<b>Temperature with Thermocouples</b>		
Sensors Range by Type (Cold junction compensation: ±0.5 °C)	J	-210 °C to 1200 °C
	K	-250 °C to 1370 °C
	T	-200 °C to 400 °C
	S	-50 °C to 1760 °C
	B	200 °C to 1820 °C
	E	-250 °C to 1000 °C
	N	-250 °C to 1300 °C
	C	0 °C to 2320 °C
L	-200 °C to 900 °C	
<b>Temperature with Pt100 and Pt1000</b>		
Current	1 mA (Pt100), 100 µA (Pt1000)	
Range	-200 °C to 850 °C	
Measurements	2 and 3 wires	
Accuracy (at 20 °C)	0.3 °C ±0.1% of reading	
Compensated Resistance	2 wires	30 Ω max.
	3 wires	50 Ω max.
<b>Resistance</b>		
Ranges	1 kΩ and 10 kΩ	
Accuracy	1 Ω (range 1 kΩ) and 10 Ω (range 10 kΩ)	
Logic Channels		
<b>Logic Input/Output</b>		
Number of Channels	12	
Maximum Permitted Voltage	24 V Cat I	
Input Impedance	4.7 kΩ	
Sampling Rate	1 ms max.	
<b>Timing Input</b>		
Number of Channels	4 (K1 to K4)	
Maximum Permitted Voltage	24 V Cat I	
Input impedance	4.7 kΩ	
Sampling Rate	1 ms max.	
Pulse Counter	0 to 10 Million, accuracy 0.1%	
Frequency Measurement	1 Hz to 10 kHz, accuracy 0.1%	
PWM Measurement	100 Hz to 2 kHz, accuracy 0.1%	
<b>Alarm Output</b>		
Number of Channels	4 Alarms (A, B, C, D)	
Output Level	0 to 5 V	

Acquisition System		
Resolution	16 bit	
Acquisition System	Scan, one sample per channel	
Sampling Interval	V >50 mV	1 ms to 20 min
	V ≤50 mV, thermocouples and Pt100 / Pt1000	2 ms to 20 min
Trigger	Date, delay, threshold, combination of thresholds (and/or), word on logic channels (and, or, slope, level)	
Pre-trigger	Variable from 0 to 100k samples	
General		
Internal Flash Drive Size	32 GB	
Maximum File Size	2 GB	
Operating Temperature	0 °C to 40 °C, 80% RH (no condensation)	
Storage Temperature	-20 °C to 60 °C	
Display	10" TFT touchscreen LCD, backlit, 1024 x 600 dots	
Power Supply	15 V / 4 A max with main adapter (100 / 240 VAC)	
Interfaces	2 x USB host, LAN (10/100 base-T with RJ45 socket)	
Battery (-BAT)	Non removable, Lithium-ion	
Typical Battery Life (-BAT)	15 hours with standby mode, 10 hours without stand-by mode	
Safety	Cat I 100 V, according to IEC61010-1	
Weight	DAS220 / 3.3 lbs (1.5 kg)	
	DAS220-BAT / 4.5 lbs (2 kg)	
Dimensions (W x H x D)	2.6" x 11.7" x 6.9" (66 x 298 x 176 mm)	
Warranty	Two Years	
Supplied Accessories	Main adapter 100 / 240 V, 25 pin male connector <sup>(1)</sup> and backshell, 10 input connectors, shoulder strap, stylus, soft wipe, screwdriver, calibration certificate and test report	
Order Information for Optional Accessories		
902401050	Analog input terminal blocks 20 pack	
902408000	Rugged carrying case	
902407000	Logic channels patch cord	
902406500	4 to 20 mA / 50 Ω shunt	
902409000	19" rack-mount kit	

(1) User configurable with solder cups.

# Thermocouple Measurement Accuracy

The thermocouple measurements are treated as voltage measurements.

For a given range of temperature measurement, the software calculates the voltage caliber the following way:

- Let  $\langle T \rangle$  the absolute value of the max. measurable value, in  $^{\circ}\text{C}$
- Add  $40^{\circ}\text{C}$  to take the max. cold welding temperature into account
- Search the corresponding voltage value  $U$  in the table of thermocouples
- Program the caliber with  $U$  included in the range.

## 17.1 J Type Thermocouple Example

You want to program a measurement range between  $-50$  and  $+50^{\circ}\text{C}$  with a J thermocouple:

- Max. absolute value  $T = 50^{\circ}\text{C}$
- Add  $40^{\circ}\text{C}$   $T + 40 = 90^{\circ}\text{C}$
- Corresponding  $U$  voltage according to the tables  $T_{\text{HJ}} U = 4.726 \text{ mV}$
- Programmed caliber:  $10 \text{ mV}$  (measurement range:  $-5\text{mV}$  to  $+5\text{mV}$ )

The measurement inaccuracies below are max. values: the typical values are half to thrice as much. The temperature measurement accuracy is the sum of several possible uncertainty causes:

- $P_l$ : linearization accuracy
- $P_s$ : weld welding accuracy
- $P_m$ : measurement accuracy of the equivalent voltage

The total accuracy  $P_t$  is then:  $P_t = P_l + P_s + P_m$

For the recorder:

- $P_l = +0.25^{\circ}\text{C}$  for all thermocouples
- $P_s = +0.5^{\circ}\text{C}$  for all thermocouples
- $P_m = 0.1\%$  of the voltage caliber  $+10\mu\text{V}$  divided by the slope of the thermocouple in  $\mu\text{V}/^{\circ}\text{C}$

## 17.2 Measurement Accuracy: $P_m$

The measurement accuracy  $P_m$  depends on the voltage caliber of the appliance (see the previous paragraph) and on the slope of the thermocouple. You shall take the slope at  $0^{\circ}\text{C}$  while knowing that it will vary as a function of the temperature, but this variation is generally of the second order for the accuracy calculation.

## 17.3 Voltage of Thermocouple (mV)

Slope of the thermocouples ( $\mu\text{V}$ )

- At 100 °C the slope of thermocouple J is  $55\mu V$
- At -100 °C slope is  $30\mu V$  .
- So the error is 2 time greater then 100°C to -100°C.

### 17.3.1 Example of Accuracy Calculation

You make a welding between -50°C and +50°C with a J thermocouple with compensation of cold welding.

$$Pt = Pl + Ps + Pm \quad (17.1)$$

**Linearization accuracy**  $Pl = +0.25^\circ C$

**Compensation of cold welding**  $Ps = +0.5^\circ C$

**Used caliber** 10mV - (see previous example)

**Accuracy for voltage measurement**  $0.1\% * 10mV + 10\mu V = 20\mu V$

**Slope of J thermocouple**  $50\mu V/^\circ C$

**Accuracy Pm**  $Pm = 20/50 = 0.4^\circ C$

**Total accuracy**  $Pt = 0.25 + 0.5 + 0.4 = 1.15^\circ C$

## 17.4 Accuracy Class - Class Index

This is one of the most important concepts of the CEI recommendation; it tends to shorten the list of specifications. To do so, it introduces the concept of PREDICTIVE CLASS that depends on the C CLASS INDEX.

The normalized values of the class index are: C = 0.1, 0.25, 0.5 and 1.

The intrinsic error (in the reference conditions) does not exceed + C% (the manufacturer may also specify this limit of the intrinsic error as an absolute value (ex. + 5  $\mu V$ ) for the first calibers).

The variations (of the measured value) with the variations of one of the influential variables in the nominal range of use do not exceed:

- C % for the position for the magnetic induction with external source and parasite voltages
- 0.5 C% for the power supply source
- 0.3 C% according to the class index at ambient temperature (0.15% for the 0.25 class).

In addition, the insensitivity range should not exceed:

- C% in the reference conditions
- 1.5C% for the maximal resistance of the external measurement circuit
- 2C% for parasite voltages

And the excess should not be more than 2C% (4C% within the limits of the power supply source). %

## 17.5 Grounding

- If the source of the signal you have to record has low internal impedance, you shall use twisted wires. In case of high impedance, you shall use shielded wires.
- When gathering grounds from the various items on the measurement line, it is good to check that there is no voltage difference between them, in order to prevent any shortcut. If any doubt, make a measurement with a voltmeter on a low resistance (i.e.  $1k\Omega$ ) between the terminals.
- If any important noise,

- When using the battery , connect the GND connection to the ground
- use the sampling period for each channel  $>20\text{ms}$
- an appropriate capacity can be placed between the ground and the - wire of the signal.