

IMPORTANT:
Read Before Using

IMPORTANT :
Lire avant usage

IMPORTANTE:
Leer antes de usar



Operating/Safety Instructions
Consignes d'utilisation/de sécurité
Instrucciones de funcionamiento y seguridad

GLM400CL



BOSCH

Call Toll Free for Consumer Information and Service Locations

Pour obtenir des informations et les adresses de nos centres de service après-vente, appelez ce numéro gratuit

Llame gratis para obtener información para el consumidor y ubicaciones de servicio

For English Version

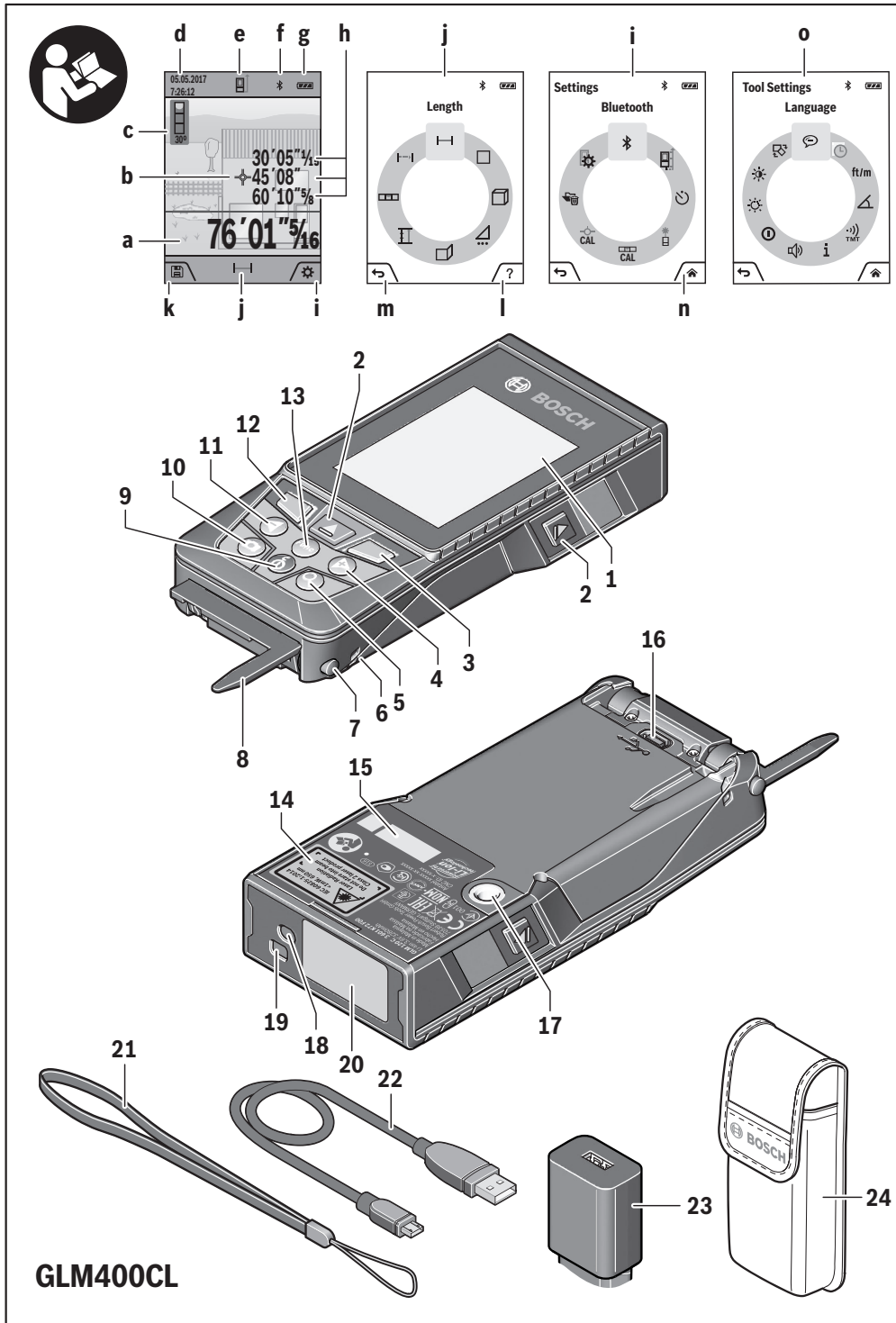

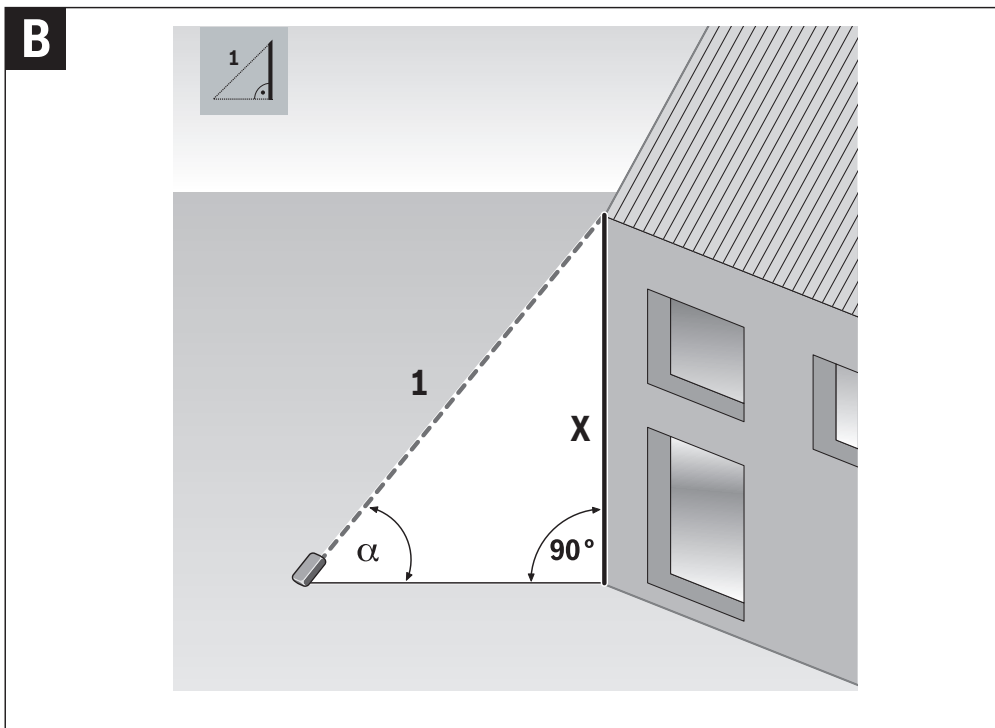
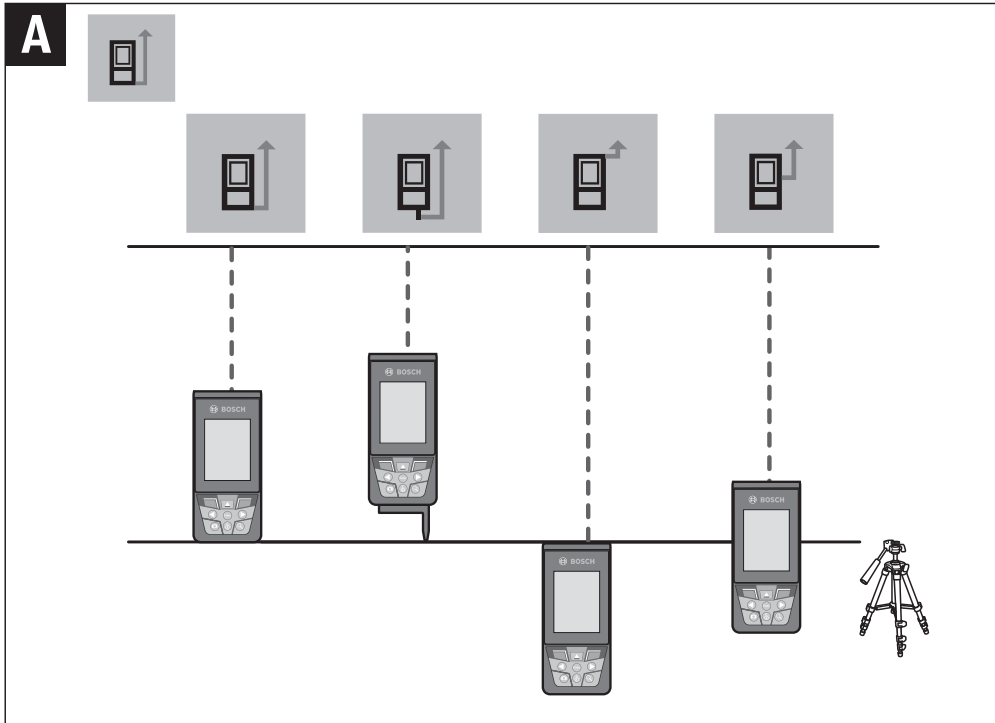

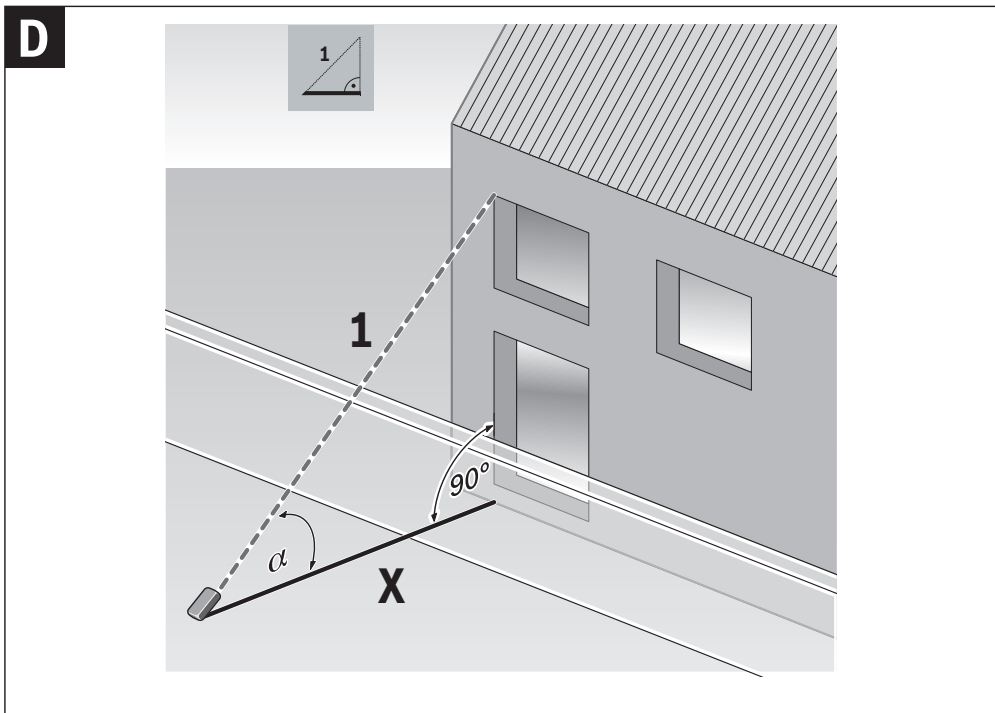
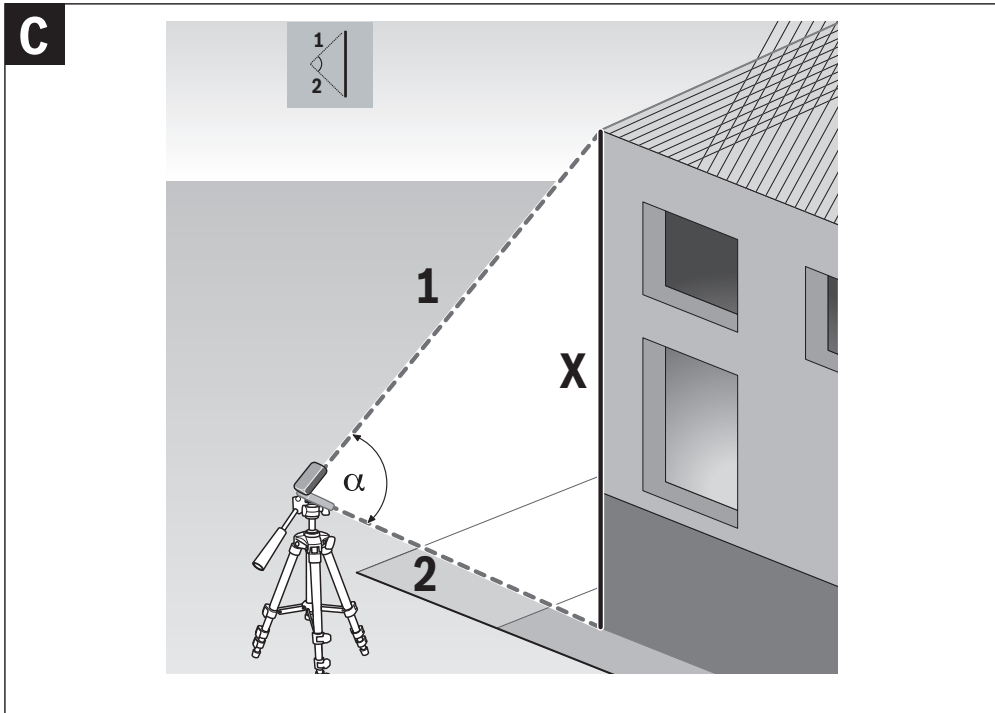

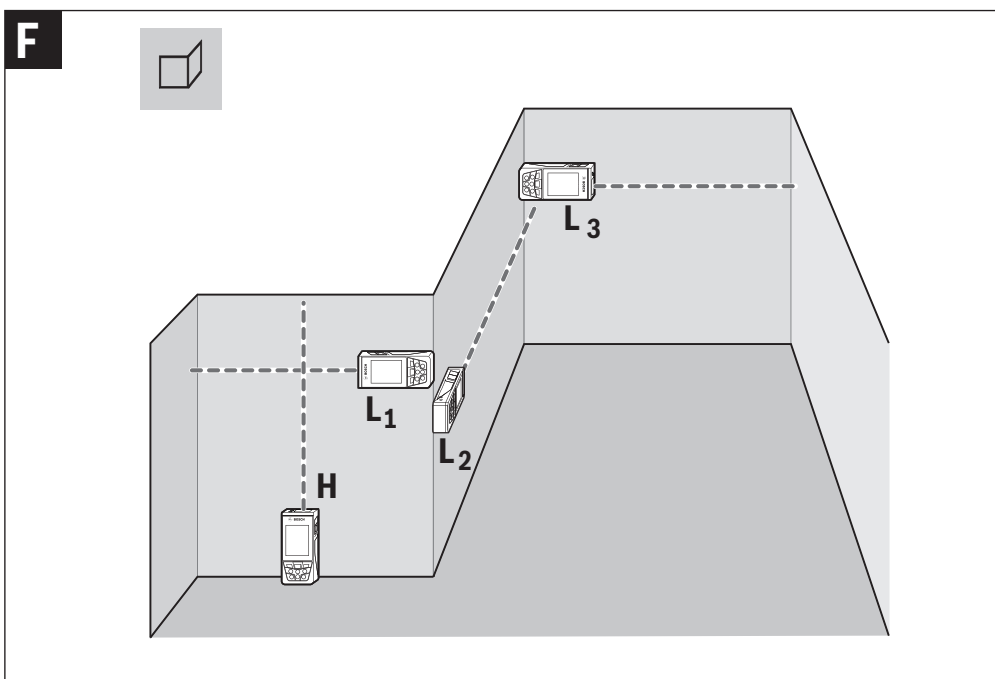
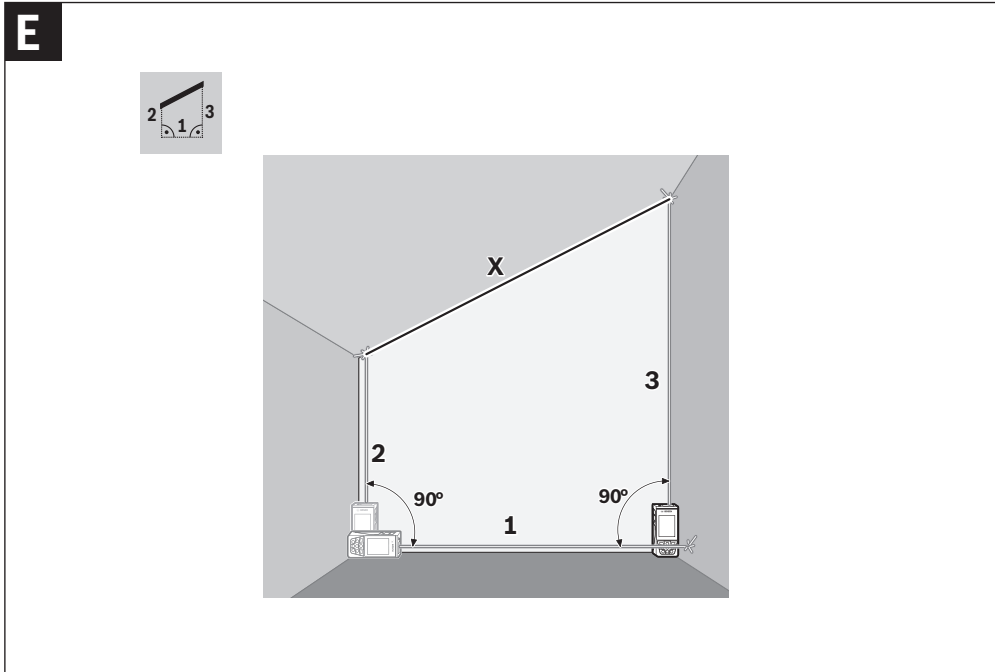

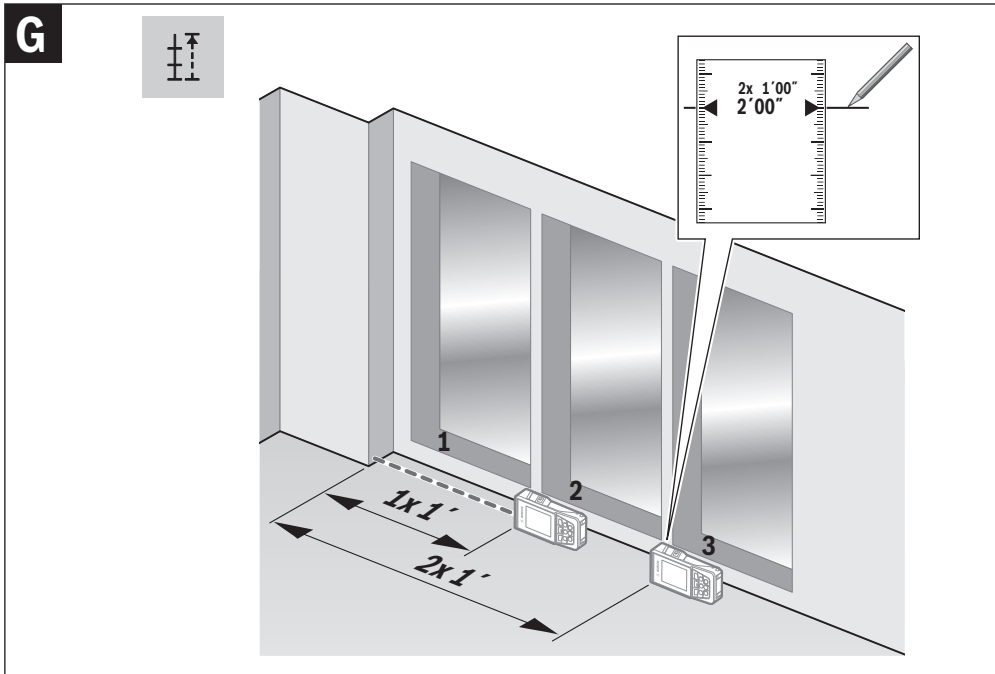

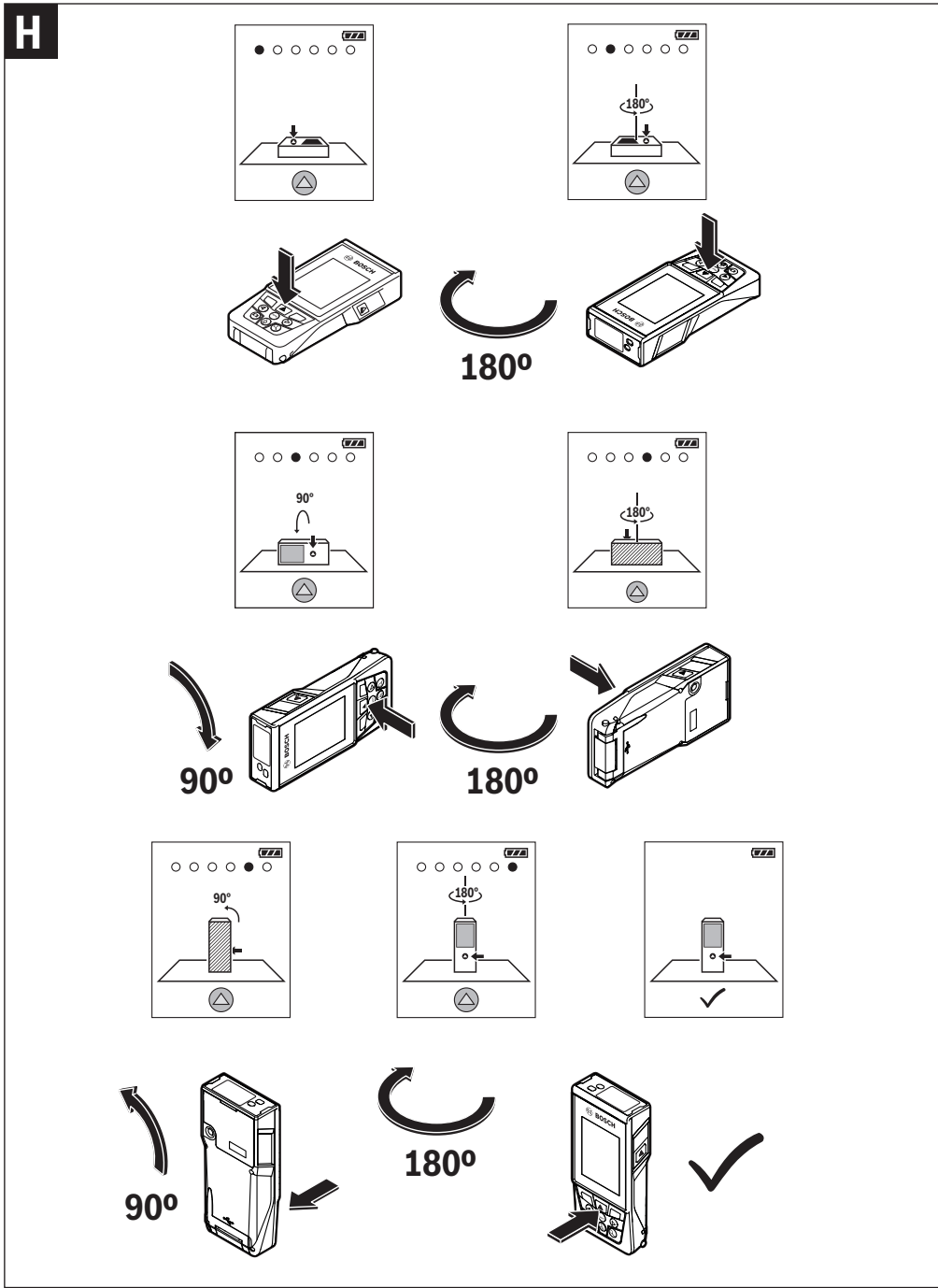

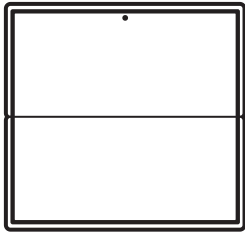

25
2 607 001 391





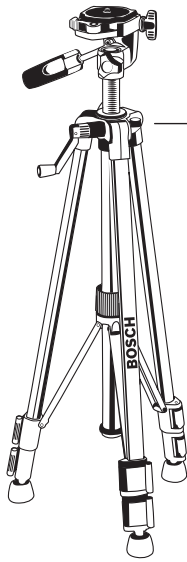

26
1 608 M00 05B



27
BT 150
0 601 096 B00

Safety Symbols

The definitions below describe the level of severity for each signal word. Please read the manual and pay attention to these symbols.

	This is the safety alert symbol. It is used to alert you to potential personal injury hazards. Obey all safety messages that follow this symbol to avoid possible injury or death.
	Read manual symbol - Alerts user to read manual.
	WARNING indicates a hazardous situation which, if not avoided, could result in death or serious injury.
	This symbol designates that this laser measure complies with Part 15 of the FCC Rules.

General Safety Rules

WARNING Read all instructions. Failure to follow all instructions listed below may result in hazardous radiation exposure, electric shock, fire and/or serious injury. The term “tool” in the warnings listed below refers to your mains-operated (corded) tool or battery-operated (cordless) tool.

**SAVE ALL WARNINGS AND INSTRUCTIONS
FOR FUTURE REFERENCE**

Work area safety

Keep work area clean and well lit. Cluttered or dark areas invite accidents.

DO NOT operate the laser tool around children or allow children to operate the laser tool. Serious eye injury could result.

DO NOT use measuring tools, attachments and accessories outdoors when lightening conditions are present.

Electrical safety



Batteries can explode or leak, cause injury or fire. To reduce this risk, always follow all instructions and warnings on the battery label and package.

Do not short any battery terminals.

Do not mix battery chemistries.

Dispose of or recycle batteries per local code.

Do not dispose of batteries in fire.

Keep batteries out of reach of children.

Personal safety

Stay alert, watch what you are doing and use common sense when operating a measuring, detection and layout tool. Do not use a measuring, detection and layout tool while you are tired or under the influence of drugs, alcohol or medication. A moment of inattention while operating measuring, detection and layout tools may result in serious personal injury or incorrect measurement results.

Use safety equipment. Always wear eye protection. Safety equipment such as dust mask, non-skid safety shoes, hard hat, or hearing protection used for appropriate conditions will reduce personal injuries.

DO NOT use any optical tools such as, but not limited to, telescopes or transits to view the laser beam. Serious eye injury could result.

DO NOT stare directly at the laser beam or project the laser beam directly into the eyes of others. Serious eye injury could result.

Use caution when using measuring tools in the vicinity of electrical hazards.

Measuring, detection and layout tool use and care

Use the correct measuring, detection and layout tool for your application. The correct measuring, detection and layout tool will do the job better and safer at the rate for which it was designed.

Do not use the measuring, detection and layout tool if the switch does not turn it on and off. Any measuring, detection and layout tool that cannot be controlled with the switch is dangerous and must be repaired.

Store idle measuring, detection and layout tools out of the reach of children and do not allow persons unfamiliar with the measuring, detection and layout tool or these instructions to operate the measuring, detection and layout tool. Measuring, detection and layout tools may be dangerous in the hands of untrained users.

Maintain measuring, detection and layout tools. Check for misalignment or binding of moving parts, breakage of parts and any other condition that may affect the measuring, detection and layout tools operation. If damaged, have the measuring, detection and layout tool repaired before use. Many accidents are caused by poorly maintained measuring, detection and layout tools.

Use the measuring, detection and layout tool, accessories, etc., in accordance with these instructions and in the manner intended for the particular type of measuring, detection and layout tool, taking into account the working conditions and the work to be performed. Use of the measuring, detection and layout tool for operations different from those intended could result in a hazardous situation.

Service

Have your measuring, detection and layout tool serviced by a qualified repair person using only approved replacement parts. This will ensure that the safety of the measuring, detection and layout tool is maintained.

Develop a periodic maintenance schedule for your measuring, detection and layout tool. Follow checking and recalibration procedures outlined in the instruction manual.

When cleaning a tool be careful not to disassemble any portion of the tool since internal wires may be misplaced or pinched or may be improperly mounted. Certain cleaning agents such as gasoline, carbon tetrachloride, ammonia, etc. may damage plastic parts.

Safety Rules for Laser Tools

The following label is on your laser tool for your safety. **ALWAYS BE AWARE** of its location when using the tool.

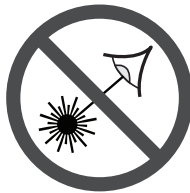

DO NOT direct the laser beam at persons or animals and do not stare into the laser beam yourself. This tool produces class 2 laser radiation and complies with 21 CFR 1040.10 and 1040.11 except for deviations pursuant to Laser Notice No. 50, dated June 24, 2007. This can lead to persons being blinded.

DO NOT place the measuring tool in a position that may cause anyone to stare into the laser beam intentionally or unintentionally. Serious eye injury could result.

Never aim the beam at a workpiece with a reflective surface. Bright shiny reflective sheet steel or similar reflective surfaces are not recommended for laser use. Reflective surfaces could direct the beam back towards the operator.

DO NOT operate the measuring tool around children or allow children to operate the measuring tool. Serious eye injury could result.

ALWAYS: Make sure that any bystanders in the vicinity of use are made aware of the dangers of looking directly into the measuring tool.

Do not use the measuring tool to photograph any people or animals, as this involves the laser beam being continuously switched on. You could blind somebody or cause accidents or eye damage with the laser beam switched on.

DO NOT remove or deface any warning or caution labels. Removing labels increases the risk of exposure to laser radiation.

Do not use the measuring tool if the display glass is visibly damaged (e.g. cracks in the surface, etc.). This poses a risk of injury.

DO NOT operate the measuring tool in combustible areas such as in the presence of flammable liquids, gases or dust.

Do not operate the measuring tool with the USB cable connected.

Do not use the measuring tool as external USB storage.

Do not use the measuring tool to photograph any people or animals, as this can involve the laser beam being continuously switched on. You could blind somebody or cause accidents or eye damage with the laser beam switched on.

Use of controls or adjustments or performance of procedures other than those specified herein may result in hazardous radiation exposure.

Do not use the laser viewing glasses as sun glasses or in traffic. The laser viewing glasses do not afford complete UV protection and reduce color perception.

DO NOT leave measuring tool “ON” unattended in any operation mode.

ALWAYS turn the measuring tool “OFF” when not in use. Leaving the measuring tool “ON” increases the risk of someone inadvertently staring into the laser beam.

ALWAYS position the measuring tool securely. Damage to the measuring tool and/or serious injury to the user could result if the measuring tool falls.

Take care to recognize the accuracy and range of the device. Measurement may not be accurate if used beyond the rated range of the device.

ALWAYS use only the accessories that are recommended by the manufacturer of your measuring tool. Use of accessories that have been designed for use with other measuring tools could result in serious injury.

DO NOT use this measuring tool for any purpose other than those outlined in this manual. This could result in serious injury.

DO NOT disassemble the measuring tool. There are no user serviceable parts inside. Disassembling the laser will void all warranties on the product. Do not modify the product in any way. Modifying the measuring tool may result in hazardous laser radiation exposure.

Repair and servicing must always be performed by a qualified repair facility. Repairs performed by unqualified personnel could result in serious injury.

Safety Warnings for Battery Chargers

- This charger is not intended for use by children and persons with physical, sensory or mental limitations or a lack of experience or knowledge. This charger can be used by children aged 8 and above and by persons who have physical, sensory or mental limitations or a lack of experience or knowledge if a person responsible for their safety supervises them or has instructed them in the safe operation of the charger and they understand the associated dangers. Otherwise, there is a danger of operating errors and injuries.
- Supervise children during use, cleaning and maintenance. This will ensure that children do not play with the charger.
- Keep the battery charger away from rain or moisture. Penetration of water in the battery charger increases the risk of an electric shock.
- Charge the measuring tool only with the supplied charger.
- Keep the battery charger clean. Contamination can lead to danger of an electric shock.
- Before each use, check the battery charger, cable and plug. If damage is detected, do not use the battery charger. Never open the battery charger yourself. Have repairs performed only by a qualified technician and only using original spare parts. Damaged battery chargers, cables and plugs increase the risk of an electric shock.

- Do not operate the battery charger on easily inflammable surfaces (e. g., paper, textiles, etc.) or surroundings. The heating of the battery charger during the charging process can pose a fire hazard.
- In case of damage and improper use of the battery, vapors may be emitted. Ventilate the area and seek medical help in case of complaints. The vapors can irritate the respiratory system.

Bluetooth®

Do not use the laser measure with Bluetooth® in the vicinity of gas stations, chemical plants, areas where there is danger of explosion and areas subject to blasting. Do not use the laser measure with Bluetooth® in airplanes. Do not use the laser measure with Bluetooth® in the vicinity of medical devices. Avoid operation in the direct vicinity of the human body over longer periods of time. When using the laser measure with Bluetooth®, interference with other devices and systems, airplanes and medical devices (e.g., cardiac pacemakers, hearing aids) may occur.

The *Bluetooth®* word mark and logos are registered trademarks owned by Bluetooth SIG, Inc. and any use of such marks by Robert Bosch Tool Corporation is under license.

ISED (Canada) Notice

This device complies with Industry Canada license-exempt RSS standard(s). Operation is subject to the following two conditions:

- (1) this device may not cause interference, and
- (2) this device must accept any interference, including interference that may cause undesired operation of the device.

FCC Caution

The manufacturer is not responsible for radio interference caused by unauthorized modifications to this equipment. Such modifications could void the user's authority to operate the equipment.

This device complies with Part 15 of the FCC Rules. Operation is subject to the following two conditions:

- 1) This device may not cause harmful interference, and
- 2) This device must accept any interference received, including interference that may cause undesired operation.

NOTE! This equipment has been tested and found to comply with the limits for a Class B digital devices, pursuant to Part 15 of the FCC rules. These limits are designed to provide reasonable protection against harmful interference in a residential installation. This equipment generates uses and can radiate radio frequency energy and, if not installed and used in accordance with the instructions, may cause harmful interference to radio communications. However, there is no guarantee that interference will not occur in a particular installation. If this equipment does cause harmful interference to radio or television reception, which can be determined by turning the equipment off and on, the user is encouraged to try to correct the interference by one or more of the following measures:

- Reorient or relocate the receiving antenna.
- Increase the separation between the equipment and receiver.
- Connect the equipment into an outlet on a circuit different from that to which the receiver is connected.
- Consult the dealer or an experienced radio/TV technician for help.

“Exposure to Radio Frequency (RF) Signals: The wireless device is a radio transmitter and receiver. It is designed and manufactured not to exceed the emission limit for exposure to radio frequency (RF) energy set by the Ministry of Health (Canada), Safety Code 6. These limits are part

of comprehensive guidelines and established permitted levels of RF energy for the general population.

These guidelines are based on the safety standards previously set by international standard bodies. These standards include a substantial safety margin designed to assure the safety of all persons, regardless of age and health.

Intended Use

The measuring tool is intended for measuring distances, lengths, heights, clearances and inclines, and for calculating areas and volumes.



The measuring results can be transmitted to other devices via *Bluetooth*[®].

Features

The numbering of the product features shown refers to the illustration of the measuring tool on the graphic page.

- 1 Display
- 2 Measuring button
- 3 Soft key
- 4 Plus button
(Select to the right)
- 5 Zoom button
- 6 Carrying strap lug
- 7 Measuring pin release
button
- 8 Measuring pin
- 9 On/Off/Clear button
- 10 Camera button
- 11 Minus button
(Select to the left)
- 12 Soft key
- 13 Function button
- 14 Laser warning label
- 15 Serial number
- 16 USB port
- 17 1/4" Tripod socket
- 18 Camera
- 19 Laser beam outlet
- 20 Reception lens
- 21 Carrying strap
- 22 USB cable
- 23 Wall charger
- 24 Protective pouch
- 25 Laser target plate*
- 26 Laser viewing glasses*
- 27 Tripod*

Display Elements

- a Result line
- b Target indicator (crosshair)
- c Display tilt angle
- d Date/time
- e Measurement reference
level
- f Connection status
 -  *Bluetooth*[®]
not activated
 -  *Bluetooth*[®]
activated
 -  *Bluetooth*[®]
connected
- g Battery charge-control
indicator
- h Measured-value lines
- i Settings (soft key)
- j Selected measuring
function
- k Internal memory (soft key)
- l Animation/Delete
- m Back (soft key)
- n Start screen (soft key)
- o Tool settings

Technical Data

Digital Laser Measure	GLM400CL
Measuring range (typical)	3 in - 400 ft (0.08 –122 m ^A)
Measuring range (typical, unfavorable conditions)	196 ft (60 m ^B)
Measuring accuracy (typical)	±1/16 in (±1.5 mm ^A)
Measuring accuracy (typical, unfavorable conditions)	±1/10 in (±3 mm ^B)
Lowest indication unit	1/32 in (0.5 mm)
Indirect Distance Measurement and Vial	
- Measuring range	0°–360° (4x90°)
Gradient measurement	
- Measuring range	0°–360° (4x90°)
- Measuring accuracy (typical)	±0.2 ^{°C/D/H}
- Lowest indication unit	0.1°
Operating temperature	+14° F to 113° F (-10° C to +45° C) ^E
Allowable charging temperature range	41°F to 104°F (5°C to 40°C)
Storage temperature	-4° F to 158° F (-20° C to +70° C)
Relative air humidity, max.	90 %
Laser class	2
Laser type	650 nm, <1mW
Laser beam diameter at 77° F (25 °C)	
- at 32 ft (10 m) distance, approx.	.35 in (9 mm)
- at 328 ft (100 m) distance, approx.	3.5 in (90 mm)
Automatic switch-off after approx.	
- Laser	20 s
- Measuring Tool	Adjustable ^G
Weight	.46 lb (0.21 kg)
Dimensions	5.5 (6.9) x 2.5 x 1.1 in (142 (176) x 64 x 28 mm)

Battery	Li-Ion
- Rated voltage	3.6 V
- Capacity	3120 mAh
- Number of battery cells	1
<hr/>	
Battery Charger	
- Charging time	approx. 5.5 h ^{D)}
- Output voltage	5.0 V
- Charging current	1000 mA
- Protection class	□ / II
<hr/>	
Degree of Protection	IP54 (dust and splash water protected) ^{D)}
<i>Bluetooth</i> [®]	<i>Bluetooth</i> [®] smart (4.1 low-energy) ^{F)}
<hr/>	
Operating frequency band	2402 – 2480 MHz
<hr/>	
Max. transmission power	8 mW
<hr/>	
Micro USB cable	USB 2.0
- Charging voltage	5.0 V
- Charging current	1000 mA
<hr/>	

- A) For measurements from the rear edge of the measuring tool, applies to high reflectivity of the target (e.g. a white-painted wall), weak backlighting and 25°C operating temperature. In addition, a deviation of ±0,05mm/m must be taken into account.
- B) For measurements from the front edge of the measuring tool, applies to high reflectivity of the target (e.g. a white-painted wall), and strong backlighting. In addition, a deviation of ±0.15 mm/m must be taken into account.
- C) After user calibration at 0° and 90°, an additional grade error of +/-0.01°/degree to 45° (max.) has to be taken into account.
- D) At 25°C operating temperature.
- E) In the continuous measurement function, the maximum operating temperature is +40°C.
- F) When using *Bluetooth*[®] Low Energy tools, it may not be possible to establish a connection depending on the model and operating system. *Bluetooth*[®] tools must support the GATT profile.
- G) Automatic switch-off of the measuring tool is adjustable after 2, 5, 10 minutes or never.
- H) The left-hand side of the measuring tool serves as the reference level for grade measurement.

A long battery runtime is achieved by means of energy-saving measures, such as deactivating the *Bluetooth*[®] function when not required, or reducing the display brightness, etc.

The measuring tool can be clearly identified with the serial number **15** on the type plate.

Initial Start-Up

- **Use only the chargers listed in the technical data.** Only these battery chargers are matched to the lithium-ion battery of your measuring tool.
- **The use of chargers from other manufacturers can lead to defects on the measuring tool; a higher voltage (e.g. 12 V) from a vehicle charger is not suitable for charging this measuring tool. The warranty is rendered void if these instructions are not followed.**
- **Observe the mains voltage!** The voltage of the power source must correspond with the data on the type plate of the battery charger.

Note: The battery is supplied partially charged. To ensure full battery capacity, completely charge the battery before using for the first time.

Note: The micro USB port **16** for connecting the micro USB cable **22** is located under the cover of the measuring pin **8**.

Press the release button **7** to open the cover.

The lithium-ion battery can be charged at any time without reducing its service life. Interrupting the charging procedure does not damage the battery. When the bottom segment of the battery charge-control indicator **g** flashes, only a few more measurements can be carried out. Charge the battery. If the frame around the segments of the battery charge indicator **g** flashes, no more measurements are possible. The measuring tool can only be used for a short time (e.g. to check entries in the measured value list). Charge the battery. Connect the measuring tool to the charger **23** using the micro USB cable **22** provided. Plug the charger **23** into the socket. The charging process begins. The battery charge-control indicator **g** indicates the charging progress. During the charging procedure, the segments flash one after the other. When all segments of battery charge-control indicator **g** are displayed, the battery is completely charged.

Disconnect the battery charger from the mains supply when not using it for longer periods. The battery can also be charged at a USB port. To do so, connect the measuring tool to a USB port using the micro USB cable.

In USB mode (charging mode, data transfer), the charging time can be noticeably longer.

The measuring tool cannot be used on its own during the charging process.

The *Bluetooth*[®] function switches off during the charging procedure. Existing connections to other devices are interrupted. This can lead to data loss.

- **Protect the battery charger against moisture!**

Notes for Optimum Handling of the Battery in the Measuring Tool

Store the measuring tool only within the allowable temperature range, see “Technical Data.” As an example, do not leave the measuring tool in a vehicle in summer.

A significantly reduced operating time after charging indicates that the battery has deteriorated and must be replaced by Bosch after-sales service.

Observe the notes for disposal.

Operation

⚠ WARNING Protect the tool against moisture and direct sun irradiation.

Do not subject the tool to extreme temperatures or variations in temperature. As an example, do not leave it in vehicles for longer periods. In case of large variations in temperature, allow the tool to adjust to the ambient temperature before putting it into operation. In case of extreme temperatures or variations in temperature, the accuracy of the tool can be impaired.

Avoid heavy impact or falling of the tool. After heavy exterior impact on the tool, an accuracy check should always be carried out before continuing to work (see “Accuracy Check of the Distance Measurement”, page 38).

⚠ WARNING **DO NOT stare directly at the laser beam or project the laser beam directly into the eyes of others.** Serious eye injury could result.

Do not leave the switched on measuring tool unattended and switch the tool off after use. Other persons could be blinded by the laser beam.

Switching On and Off

During work, ensure that the reception lens **20**, laser beam output **19**, and camera **18** are not closed off or covered, otherwise correct measurement will not be possible.

- To **switch on** the measuring tool and the laser, briefly press the On/Off button **9** [⏻], front or side measuring button **2** [▲].

Do not point the laser beam at persons or animals and do not look into the laser beam yourself, not even from a large distance.

- To **switch off** the laser, press the On/Off button **9** [⏻].
- To **switch off** the digital viewfinder, press the digital viewfinder button **10**.
- To **switch off** the measuring tool, press and hold the On/Off button **9** [⏻].

The measured values and device settings in the memory are retained when you switch the tool off.

Measuring Procedure

Once switched on, the measuring tool is in the length measurement function. For a different measuring function, press the button **13** [Func]. Select the desired measuring function with the buttons **4** [+] or the button **11** [-] (see “Measuring Functions”, page 29). Activate the measuring function with button **13** [Func] or with the measuring button **2** [▲].

After switching on, the rear edge of the measuring tool is preset as the reference level for the measurement. To change the reference level, see “Selecting the Reference Level”, page 24.

Place the measuring tool against the desired starting point of the measurement (e.g. a wall).

Note: If the measuring tool has been switched on using the On/Off button **9** [⏻], briefly press the measuring button **2** [▲] to switch the laser on.

To initiate the measurement, briefly press the measuring button **2** [▲]. Then the laser beam is switched off. For a

further measurement, repeat this process.

With the laser beam continuously switched on and in the the continuous measurement function, measurement will begin after the measuring button **2** [▲] is pressed for the first time.

Do not point the laser beam at persons or animals and do not look into the laser beam yourself, not even from a large distance.

Note: The measured value typically appears within 0.5 s and no later than approx. 4 s. The duration of the measurement depends on the distance, the lighting conditions and the reflective properties of the target surface. Upon completion of the measurement, the laser beam is automatically switched off. The continuously switched-on laser beam is not switched off after the measurement (see “Permanent Laser Beam”, page 25).

Selecting the Reference Level (see figure A)

You can choose between four different reference levels for the measurement:

- the rear measuring-tool edge (e.g. when measuring onward from a wall),
- the tip of the 180° folded-out measuring pin **8** (e.g. when measuring from a corner),
- the front measuring-tool edge (e.g. when measuring onward from a table edge),
- the center of thread **17** (e.g. for tripod measurements).

Folding out and in of the measuring pin **8** by 180° is detected automatically and the appropriate reference level is suggested. Confirm the setting by pressing the measuring button **2** [▲].

Use the soft key **3** [■] to select the basic settings for the measuring tool. Use buttons **4** [+] or **11** [-] to select the reference level and confirm this by pressing button **13** [Func].

The rear edge of the measuring tool is automatically preset as the reference level every time the measuring tool is switched on.

Permanent Laser Beam

If necessary, you can switch the measuring tool to permanent laser beam operation. To do so, use soft key **3** [▲] to select the basic settings for the measuring tool. Use buttons **4** [+] or **11** [-] to select the permanent laser beam and confirm this by pressing button **13** [Func].

Do not point the laser beam at persons or animals and do not look into the laser beam yourself, not even from a large distance.

In this setting, the laser beam remains switched on even between measurements; measurement simply requires one brief press of the measuring button **2** [▲].









The permanent laser beam can be switched off again in the basic settings or automatically when the measuring tool is switched off.

“Settings” Menu

To enter the “settings” menu (i) briefly press soft key **3** [▲] or press and hold button **13** [Func].

Use button **4** [+] or **11** [-] to select the relevant basic setting and press button **13** [Func] to select the required setting.

To exit the “settings” menu, press the On/Off button **9** [⏻] or soft key **12** [▼].

⚙ Settings	
	Bluetooth®
	Reference Edge
	Meas Timer
	Permanent Laser Beam
	Tilt Calibration
	Viewfinder User Calibration
	Internal Memory
	Tool Settings

Timer Function

The timer function is useful when measuring in hard-to-reach areas, for example, or when the measuring tool should be kept stationary during measurement.

Select the timer function in the settings. Select the required time period between triggering the timer and starting measurement and confirm by pressing the measuring button **2 [▲]** or button **13 [Func]**.

Next, press the measuring button **2 [▲]** to switch on the laser beam and focus on the target. Press the measuring button **2 [▲]** once more to start the measurement. The measurement will begin after the set time period has expired. The measured value is displayed in the result line a.

The time period between triggering the timer and starting measurement is displayed in the status bar at the top.

Continuous measurement and minimum/maximum measurement are not possible with the timer function enabled.

The timer remains enabled until the measuring tool is switched off or until the timer is switched off in the menu “settings”.

Camera

Switching on the measuring tool automatically switches on the camera **18**. To switch it off, press the camera button **10**.

Optimizing Visibility of the Laser Beam

Especially when using the measuring tool outdoors, in sunlight and also over long distances indoors, it may be that the laser point is not visible. The visibility of the laser point/measuring target can be improved additionally to switching on the camera by:











- Setting the display brightness (tool settings)
- Using the zoom by pressing button **5**

“Tool” Menu

Select the menu “Tool” in the menu “Settings”.

Use button **4 [+]** or **11 [-]** to select the desired tool setting and confirm with button **13 [Func]**. Select the desired tool setting.

To exit the “Tool” menu (**o**), press the On/Off/Clear button **9 [C]** or soft key **12 [▼]**.

 Tool Settings	
	Language
	Time & Date
ft/m	Measurement unit
	Angle unit
 BND	BlueHound
i	Tool Information
	Audio Signals
	Shutdown Time
	Dimming
	Brightness
	Auto Rotate

Setting the Language

Select the language in the basic settings (general settings).

Set the required language and confirm by pressing button **13 [Func]**.

Setting the Date and Time

Select the date and time in the basic settings (general settings).

Set the date and time and confirm by pressing soft key **12 [▼]**.

Changing the Unit of Measure

Select the “Measurement unit” in the tool settings.

Unit of measure “in” (inches) is set by default.

Set the required unit of measure and confirm by pressing button **13 [Func]**.

To exit the menu item, press the On/Off/Clear button **9 [C]** or soft key **3 [■]**. The selected setting remains saved after you switch off the measuring tool.

Changing the Angle Unit

Select the “Angle unit” in the tool settings.

Angle unit “°” (grade) is set by default.

Set the required angle unit and confirm by pressing button **13 [Func]**.

To exit the menu item, press the On/Off/Clear button **9 [C]** or soft key **3 [■]**. The selected setting remains saved after you switch off the measuring tool.

BlueHound

Select “BlueHound” in the tool settings.

Confirm the setting by pressing button **13 [Func]**.

An initial activation is required. Data transmission is only possible with the corresponding app or the corresponding PC program.

BlueHound can be disabled at any time.

Display Illumination

Select the display illumination in the basic settings (general settings).

The display illumination is continuously switched on. When no button is pressed, the display illumination is dimmed after approx. 30 seconds to preserve the batteries.

The time until start of dimming is adjustable (tool settings).

The brightness of the display can be adjusted to the surrounding conditions in multiple increments (general settings).

Measuring Functions

Note: Integrated Help Function

Help in the form of an animation is stored in the measuring tool for each measuring function. To do so, select button **13 [Func]**, buttons **4 [+]** or **11 [-]** and then soft key **3 [■]**.

The animation shows you the detailed procedure for the selected measuring function. The animation can be stopped and started again at any time. You can scroll forward and back with buttons **4 [+]** or **11 [-]**.

Length Measurement

Select the length measurement **I—|**.

To switch on the laser beam, briefly press the measuring button **2 [▲]**.

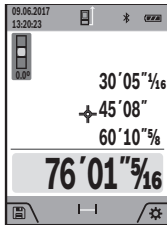

To measure, briefly press the measuring button **2 [▲]**. The measured value will be shown at the bottom of the display.

Repeat the above-mentioned steps for each subsequent measurement. The last measured value is at the bottom of the display, the penultimate measured value is above it, and so on.

Continuous Measurement (Tracking)

For continuous measurements, the measuring tool can be moved relative to the target, whereby the measuring value is updated approx. every 0.5 seconds. In this manner, as an example, you can move a certain distance away from a wall, while the actual distance can always be read.

Select the continuous measurement **I—|→**.

To switch on the laser beam, briefly press the measuring button **2 [▲]**.

Move the measuring tool until the required distance value is indicated in the bottom of the display.

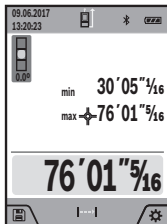

Briefly pressing the measuring button **2 [▲]** interrupts the continuous measurement. The current measured value will be shown at the bottom of the display. The maximum and minimum measured value appear above it. Pressing the measuring button **2 [▲]** once more restarts the continuous measurement.

Continuous measurement automatically switches off after 5 mins.

Area Measurement

Select the area measurement .

Then measure the width and length one after the other as with a length measurement. The laser beam remains switched on between the two measurements. The distance to be measured flashes in the indicator for area measurement .

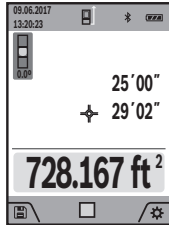

The first measured value is shown at the top of the display.

After the second measurement has been completed, the area will be automatically calculated and displayed. The end result is shown at the bottom of the display, while the individual measured values are shown above it.

Volume Measurement

Select the volume measurement .

Then measure the width, length and depth one after the other as with a length measurement. The laser beam remains switched on between the three measurements. The distance to be measured flashes in the indicator for volume measurement .

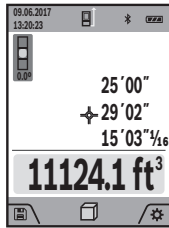

The first measured value is shown at the top of the display.

After the third measurement has been completed, the volume will be automatically calculated and displayed. The end result is shown at the bottom of the display, while the individual measured values are shown above it.

Indirect Distance Measurement

Select the indirect distance measurement .

There are four measuring functions available for the indirect distance measurement, each of which is capable of determining different distances.

The indirect distance measurement is used to measure distances that cannot be measured directly because an obstacle would obstruct the laser beam or no target surface is available as a reflector. This measuring procedure can only be used in vertical direction. Any deviation in horizontal direction leads to measuring errors.

Note: Indirect distance measurement is always less accurate

than direct distance measurement. Depending on application, greater measuring errors are possible than with direct distance measurement. To improve the measuring accuracy, we recommend using a tripod (accessory).

The laser beam remains switched on between the individual measurements.

a) Indirect height measurement (see figure B)

Select the indirect height measurement .

Ensure that the measuring tool is at the same height as the lower measuring point. Then tilt the measuring tool around the reference level and measure the distance “1” as for a length measurement (displayed as a red line).

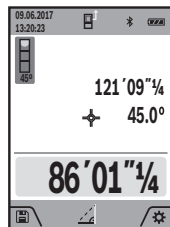

Upon completion of the measurement, the result for the sought distance “X” is displayed in the result line **a**. The measuring values for the distance “1” and the angle “ α ” are displayed in the measured-value lines **h**.

b) Double indirect height measurement (see figure C)

The measuring tool can indirectly measure all distances, which lie in the vertical level of the measuring tool.

Select the double indirect height measurement .

Measure distances “1” and “2” in this sequence as for a length measurement.

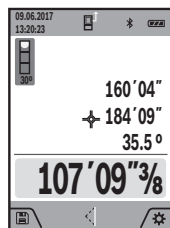

Upon completion of the measurement, the result for the sought distance “X” is displayed in the result line **a**. The measuring values for the distances “1”, “2” and the angle “ α ” are displayed in the measured-value lines **h**.

Pay attention that the reference plane of the measurement (e.g. the rear edge of the measuring tool) remains exactly at the same location for all individual measurements within a measuring sequence.

c) Indirect length measurement (see figure D)

Select the indirect length measurement .

Pay attention that the measuring tool is positioned at the same height as the sought measuring point. Now, tilt the measuring tool around the reference plane and measure distance “1” as for a length measurement.

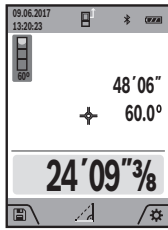

Upon completion of the measurement, the result for the sought distance “X” is displayed in the result line a. The measuring values for the distance “1” and the angle “ α ” are displayed in the measured-value lines h.

d) Trapezium measurement (see figure E)

The trapezium measurement can be used to determine the length of a roof slope, for example.

Select the trapezium measurement .

Measure distances “1”, “2” and “3” in this sequence with a length measurement. Pay attention that the measurement of distance “3” starts exactly at the end point of distance “1” and that a right angle exists between distances “1” and “2” as well as between “1” and “3”.

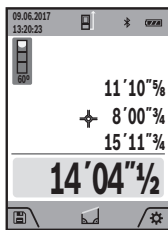

Upon completion of the last measurement, the result for the sought distance “E” is displayed in the result line a. The individual measured values are displayed in the measured-value lines h.

Wall Area Measurement (see figure F)

The wall area measurement is used to determine the sum of several individual surfaces with a common height.

In the illustrated example, the total area of several walls should be determined, which have the same ceiling height H, but different lengths L.

Select the wall area measurement .

Measure the ceiling height H as with a length measurement.

The measured value is displayed in the top measured-value line. The laser remains switched on.

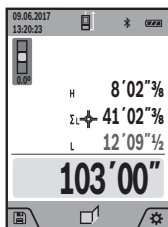

Then measure the length L1 of the first wall. The surface is automatically calculated and displayed in the result line a. The last length measured value is in the bottom measured-value line h. The laser remains switched on.

Now measure the length **L2** of the second wall. The individual measured value displayed in the measured-value line **h** is added to the length **L1**. The sum of the two lengths (displayed in the bottom measured-value line **h**) is multiplied by the saved height **H**. The total surface value is displayed in the result line **a**.

You can measure any number of lengths **LX**, which will be automatically added and multiplied by the height **H**.

The requirement for a correct area calculation is that the first measured length (for example the ceiling height **H**) is identical for all sub-areas.

Stake Out Function (see figure G)

The stake out function repeatedly measures a defined length (distance). These lengths can be transferred to a surface, for example to enable material to be cut into pieces of equal lengths or to install stud walls in a drywall construction. The minimum adjustable length is 3.2 ft (0,1m), the maximum adjustable length is 164 ft (50m).

Select the stake out function .

Set the desired length. Using button **13 [Func]** select the corresponding digit/position and change the value with button **4 [+]** or button **11 [-]**.

Begin the stake out function by pressing the measuring button **2 [▲]** and slowly move away from the starting point.

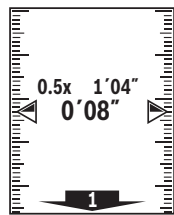

The measuring tool continuously measures the distance to the starting point. The defined length and the current measured value are thereby displayed. The lower or upper arrow displays the shortest distance to the next or last marking.

Note: The continuous measuring enables you to set a measured value as a defined length by pressing the button **3**. The distance from the marking is shown in the display in the marking function. The reference is not the edge of the measuring tool.

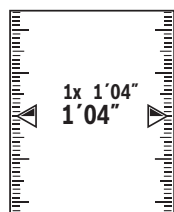

The left factor specifies how many times the defined length has already been reached. The green arrows on either side of the display indicate the reaching of a length for marking purposes.

Red arrows or a red label indicate the actual value if the reference value is outside the display.

Gradient Measurement/Digital Spirit Level

Select the inclination measurement/digital spirit level .

The measuring tool automatically switches between two states.

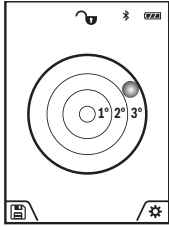

The digital spirit level is used to check the horizontal or vertical alignment of an object (e.g. washing machine, refrigerator, etc.). When the inclination 3° exceeds, the ball in the display lights red.

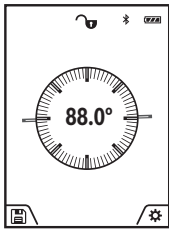

Gradient measurement is used to measure a slope or incline (e.g. of stairs, railings, when fitting furniture, laying pipes, etc.). The left-hand side of the measuring tool serves as the reference level for grade measurement. If the display flashes during measurement, the measuring tool has been tipped too heavily to the side.

Memory Functions

The value or end result of each completed measurement is automatically saved.

Tip: You can save your measurement as a photo for reference.

The following information is printed on the photo:

- Measuring result
- Measuring function used
- Reference
- Date and time
- Tilt angle (only with spirit level switched on).

Memory value display

A maximum of 50 values can be retrieved (measured values or photos with measured values).

Select the memory function using soft key **12** .

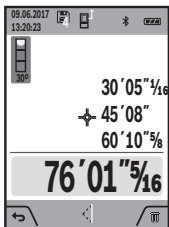

The number of the memory value is shown at the top of the display, the corresponding memory value is shown at the bottom and the corresponding measuring function is shown on the left.

Press button **4**  to browse forwards through the saved values.

Press button **11** [–] to browse backwards through the saved values.

If there is no value available in the memory, “**0.000**” is shown at the bottom of the display and “**0**” at the top.

The oldest value is located in position **1** in the memory, while the newest value is in position **50** (when 50 memory values are available). When a further value is saved, the oldest value in the memory is always deleted.

Deleting the Memory

To delete the content of the memory, press soft key **12** [▼] and then, as many times as required, press soft key **3** [■].

To delete all values stored in the memory, the function can be used. Confirm by pressing soft key **12** [▼].

Adding/Subtracting Values

Measured values or end results can be added or subtracted.

Adding Values

The following example describes the addition of areas:

Measure an area as described in section “Area Measurement,” see page 30.

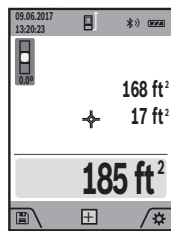

Press the button **4** [+]. The calculated area and the symbol “+” will be displayed.

Press the measuring button **2** [▲] to start another area measurement. Measure the area as described in section “Area Measurement,” see page 30. Once the second measurement is completed, the result of the second area measurement is displayed below. To show the end result, press the measurement button **2** [▲] once more.

Note: With a length measurement, the end result is displayed immediately.

Subtracting Values

To subtract values, press button **11** [–]. The subsequent steps are the same as for “Adding Values”.

Deleting Measured Values

Briefly pressing the On/Off/Clear button **9** [⊙] will delete the last measured value in all measuring functions.

Bluetooth® Interface



Do not turn on laser remotely using the Bosch app without line of sight to the laser tool. The sudden bright laser beam may increase the risk of personal injury or property damage.

Ensure there are no bystanders in the direct path of the laser beam before turning on the laser remotely.

Data Transmission to other Devices

The measuring tool is equipped with a *Bluetooth®* module, which enables data transmission via radio technology to certain mobile terminals/devices with a *Bluetooth®* interface (e.g., smartphones, tablets).

For information on the necessary system requirements for a *Bluetooth®* connection, please refer to the Bosch website.

Further information can be found on the Bosch product page.

For data transmission via *Bluetooth®*, time delays between mobile terminal/device and measuring tool may occur. This can be possible due to the distance between both devices or the object being measured.

Activating the Bluetooth® Interface for Data Transmission to a Mobile Terminal/Device

The *Bluetooth®* interface is activated in the basic settings. To activate the *Bluetooth®* signal, press button **4 [+]**. Ensure that the *Bluetooth®* interface is activated on your mobile end device. The special Bosch “Measuring Master” app is available to extend the range of functions of the mobile end device and to make data easier to process. You can download this from the store for your end device type.

The connection between mobile terminal/device and measuring tool is established after the Bosch application has started. If multiple active measuring tools are found, select the appropriate measuring tool using the serial number.

The connection status, as well as the active connection (**f**), are shown in the display **1** of the measuring tool.

Deactivating the *Bluetooth*[®] Interface

The *Bluetooth*[®] connection is deactivated in the basic settings. To deactivate the *Bluetooth*[®] signal, press button **11** [-] or switch off the measuring tool.

USB port

Data via USB Interface can be transferred from the measuring tool to certain devices with a USB port (e.g. computer, notebook) via its micro USB connection.

Connect the measuring tool to your computer or notebook using the micro USB cable. The operating system on your computer or notebook will automatically recognize the measuring tool as a drive.

Note: As soon as the measuring tool is connected to a computer or notebook via the micro USB cable, the lithium ion battery is charged. The charge duration varies depending on the charging current.

Working Advice

Further information can be found on the Bosch product page.

The measuring tool is equipped with a radio interface. Local operating restrictions, e.g. in airplanes or hospitals, are to be observed.

General Information

The reception lens **20**, the laser beam output **19** and the camera **18** must not be covered during measurement.

The measuring tool must not be moved while taking a measurement. Therefore, place the measuring tool, as far as this is possible, against or on a firm stop or supporting surface.

Influence Effects on the Measuring Range

The measuring range depends on the lighting conditions and the reflective properties of the target surface. For better visibility of the laser beam in strong extraneous light, use the integrated camera **18**, the laser viewing glasses **26** (accessory) and the laser target plate **25** (accessory) or shade the target area.

Influence Effects on the Measuring Result

Due to physical effects, faulty measurements cannot be excluded when measuring on different surfaces. Included here are:

- Transparent surfaces (e.g., glass, water),
- Reflecting surfaces (e.g., polished metal, glass),
- Porous surfaces (e.g. insulation materials),
- Structured surfaces (e.g., roughcast, natural stone).

If required, use the laser target plate **25** (accessory) on these surfaces.

Furthermore, faulty measurements are also possible when sighting inclined target surfaces.

Also, air layers with varying temperatures or indirectly received reflections can affect the measured value.

Accuracy Check and Calibration of the Grade Measurement (see figure H)

Regularly check the accuracy of the grade measurement. This is done by carrying out a reversal measurement. For this, place the measuring tool on a table and measure the grade.

Turn the measuring tool by 180° and measure the grade again. The difference of the indicated reading may not exceed by more than 0.3° (max.).

In the event of larger deviations, you have to recalibrate the measuring tool. For this, select $\overline{\text{CAL}}$. Follow the instructions on the display.

After severe temperature changes and impact, we recommend an accuracy check and, if required, to recalibrate the measuring tool. After a temperature change, the measuring tool must acclimate for a while before calibrating.

Accuracy Check of the Distance Measurement

The accuracy of the measuring tool can be checked as follows:

- Select a permanently unchangeable measuring section which is approx. 9.8 to 32 ft (3 to 10 m) long and which you know the exact length of (e.g. room width, door opening). The measurement should be performed under favorable conditions, i.e. the measuring section should be indoors with weak backlighting and the target area of the measurement should be smooth and reflect well (e.g. a white-painted wall).
- Measure the distance 10 times in succession.

The deviation of the individual measurements from the average value must not exceed ± 0.07 in (± 2 mm) over the entire measuring section in favorable conditions. Record the measurements in order to be able to compare the accuracy at a later date.

Checking Accuracy and Calibrating the Target Indicator (Crosshair)

Check the accuracy of the alignment of the laser and target indicator on a regular basis.

- Select a bright area at least 10 m away with as little illumination as possible as the target.
- Check whether the laser point is inside the target indicator in the display.

If the laser point is not inside the target indicator, you must recalibrate the target indicator. To do so, select  in the settings. Follow the instructions on the display.

Working with the Tripod (Accessory)

The use of a tripod is particularly necessary for larger distances. Position the measuring tool with the 1/4" thread **17** onto the quick-change plate of the tripod **27** or a commercially available camera tripod. Tighten the measuring tool with the locking screw of the quick-change plate.

Set the reference level for measurements with a tripod in the basic settings (thread reference level).

Troubleshooting

Cause	Corrective Measure
Temperature warning flashes, measurement not possible	
Measuring tool not within the temperature range between +14°F and 113°F (-10°C and +45°C).	Wait until the measuring tool has reached the operating temperature.
“ERROR” indication in the display	
Addition/Subtraction of measured values with different units of measure.	Only add/subtract measured values with the same units of measure.
The angle between the laser beam and the target is too acute.	Enlarge the angle between the laser beam and the target.
The target surface reflects too intensely (e.g. a mirror) or insufficiently (e.g. black fabric), or the ambient light is too bright.	Work with the laser target plate 25 (accessory).
The laser beam outlet 19 , reception lens 20 , and/or camera 18 are misted up (e.g. due to a rapid temperature change).	Wipe the laser beam outlet 19 , the reception lens 20 , and/or camera 18 dry using a soft cloth.
Calculated value is greater than 1 999 999 or smaller than -999 999in/in2/in3.	Divide calculation into intermediate steps.
“CAL” and “ERROR” indication in the display	
The calibration of the grade measurement was not carried out in the correct sequence or in the correct positions.	Repeat the calibration according to the instructions on the display and in the operating instructions.

Cause	Corrective Measure
The surfaces used for the calibration were not accurately aligned (horizontal or vertical).	Repeat the calibration on a horizontal or vertical surface; if required, check the surface first with a level.
The measuring tool was moved or tilted while pressing the button.	Repeat the calibration and hold the measuring tool in place while pressing the button.
Bluetooth® cannot be activated	
The battery is too low.	Charge the measuring tool's battery.
No Bluetooth® connection	
Failure of the <i>Bluetooth®</i> connection	<p>Switch off and restart <i>Bluetooth®</i> on the measuring tool and the mobile device.</p> <p>Check the application on your mobile terminal/device.</p> <p>Check if <i>Bluetooth®</i> is activated on your measuring tool and mobile terminal/device.</p> <p>Check your mobile terminal/device for overload.</p> <p>Reduce the distance between measuring tool and your mobile terminal/device.</p> <p>Avoid obstructions (e.g., reinforced concrete, metal doors) between measuring tool and your mobile terminal/device. Observe clearance to electromagnetic disturbances (e.g., WLAN transmitters).</p>

Cause	Corrective Measure
Battery charge indicator (g), temperature warning and “ERROR” indicator in the display	
Temperature of the measuring tool not within the allowable charge-temperature range.	Wait until the charge-temperature range is reached.
Battery charge-control indicator (g) and “ERROR” indication in the display	
Battery charging voltage not correct	Check if the plug-in connection has been established correctly and if the battery charger is operating properly. When the unit symbol is flashing, the battery is defective and must be replaced by a Bosch after-sales service.
Measuring result not plausible	
The target surface does not reflect correctly (e.g. water, glass).	Cover off the target surface.
Laser beam output 19 , reception lens 20 or camera 18 is covered.	Keep the laser beam output 19 , reception lens 20 and camera 18 clear.
Wrong reference level set.	Select reference level that corresponds to measurement.
Obstruction in path of laser beam.	Laser point must be completely on target surface.
Data transmission via USB interface not possible	
Micro USB cable	<p>Check the proper and tight seating of the micro USB cable.</p> <p>Check the micro USB cable for damage.</p>



The measuring tool monitors the correct function for each measurement. When a defect is determined, only the symbol shown aside flashes in the display. In this case, or when the above mentioned corrective measures cannot correct an error, have the measuring tool checked by an after-sales service agent for Bosch power tools.

Maintenance and Service



Keep the measuring tool clean at all times.

Do not immerse the measuring tool into water or other fluids.

Wipe off debris using a moist and soft cloth. Do not use any cleaning agents or solvents.

Take extra special care when cleaning the reception lens 20, the laser beam exit opening 19 and the camera 18:

Ensure that there is no lint on the reception lens, the laser beam exit opening and the digital viewfinder. Clean the reception lens, the laser beam exit opening and the viewfinder only with cleaning agents which are also suitable for camera lenses. Do not attempt to remove dirt from the reception lens, the laser beam exit opening and the viewfinder using pointed objects, and do not wipe over the reception lens, the laser beam exit opening and the viewfinder (risk of scratching).

If the measuring tool should fail despite the care taken in manufacturing and testing procedures, repair should be carried out by an authorized after-sales service center for Bosch power tools. Do not open the measuring tool yourself.

In all correspondence and spare parts orders, please always include the 10-digit article number given on the type plate of the measuring tool.

ENVIRONMENT PROTECTION



Recycle raw materials and batteries instead of disposing of waste. The unit, accessories, packaging and used batteries should be sorted for environmentally friendly recycling in accordance with the latest regulations.

LIMITED WARRANTY OF BOSCH LASER AND MEASURING TOOL PRODUCTS

Robert Bosch Tool Corporation (“Seller”) warrants to the original purchaser only, that all Bosch lasers and measuring tools will be free from defects in material or workmanship for a period of one (1) year from date of purchase. Bosch will extend warranty coverage to two (2) years when you register your product within eight (8) weeks after date of purchase. Product registration card must be complete and mailed to Bosch (postmarked within eight weeks after date of purchase), or you may register on-line. If you choose not to register your product, a one (1) year limited warranty will apply to your product.

30 Day Money Back Refund or Replacement -

If you are not completely satisfied with the performance of your laser and measuring tools, for any reason, you can return it to your Bosch dealer within 30 days of the date of purchase for a full refund or replacement. To obtain this 30-Day Refund or Replacement, your return must be accompanied by the original receipt for purchase of the laser or optical instrument product. A maximum of 2 returns per customer will be permitted.

SELLER’S SOLE OBLIGATION AND YOUR EXCLUSIVE REMEDY under this Limited Warranty and, to the extent permitted by law, any warranty or condition implied by law, shall be the repair or replacement of parts, without charge, which are defective in material or workmanship and which have not been misused, carelessly handled, or misrepaired by persons other than Seller or Authorized Service Center. To make a claim under this Limited Warranty, you must return the complete Bosch laser or measuring tool, transportation prepaid, to any BOSCH Factory Service Center or Authorized Service Center. Please include a dated proof of purchase with your tool. For locations of nearby service centers, please use our on-line service locator or call.

THIS WARRANTY PROGRAM DOES NOT APPLY TO TRIPODS AND RODS. Robert Bosch Tool Corporation (“Seller”) warrants tripods and leveling rods for a period of one (1) year from date of purchase.

THIS LIMITED WARRANTY DOES NOT APPLY TO OTHER ACCESSORY ITEMS AND RELATED ITEMS. THESE ITEMS RECEIVE A 90 DAY LIMITED WARRANTY.

To make a claim under this Limited Warranty, you must return the complete product, transportation prepaid. For details to make a claim under this Limited Warranty please visit.

ANY IMPLIED WARRANTIES SHALL BE LIMITED IN DURATION TO ONE YEAR FROM DATE OF PURCHASE. SOME STATES IN THE U.S., AND SOME CANADIAN PROVINCES DO NOT ALLOW LIMITATIONS ON HOW LONG AN IMPLIED WARRANTY LASTS, SO THE ABOVE LIMITATION MAY NOT APPLY TO YOU.

IN NO EVENT SHALL SELLER BE LIABLE FOR ANY INCIDENTAL OR CONSEQUENTIAL DAMAGES (INCLUDING BUT NOT LIMITED TO LIABILITY FOR LOSS OF PROFITS) ARISING FROM THE SALE OR USE OF THIS PRODUCT. SOME STATES IN THE U.S., AND SOME CANADIAN PROVINCES DO NOT ALLOW THE EXCLUSION OR LIMITATION OF INCIDENTAL OR CONSEQUENTIAL DAMAGES, SO THE ABOVE LIMITATION MAY NOT APPLY TO YOU.

THIS LIMITED WARRANTY GIVES YOU SPECIFIC LEGAL RIGHTS, AND YOU MAY ALSO HAVE OTHER RIGHTS WHICH VARY FROM STATE TO STATE IN THE U.S., OR PROVINCE TO PROVINCE IN CANADA AND FROM COUNTRY TO COUNTRY.

THIS LIMITED WARRANTY APPLIES ONLY TO PRODUCTS SOLD WITHIN THE UNITED STATES OF AMERICA, CANADA AND THE COMMONWEALTH OF PUERTO RICO. FOR WARRANTY COVERAGE WITHIN OTHER COUNTRIES, CONTACT YOUR LOCAL BOSCH DEALER OR IMPORTER.