

ENGLISH

User manual



Table of contents:

1.	PRECAUTIONS AND SAFETY MEASURES	3
1.1.	Preliminary instructions	4
1.2.	During use	4
1.3.	After use	4
1.4.	Definition of measurement (overvoltage) category	5
2.	GENERAL DESCRIPTION	6
2.1.	Measuring average values and TRMS values	7
2.2.	Definition of true root mean square value and crest factor	7
2.3.	Harmonics	7
3.	PREPARATION FOR USE	8
3.1.	Initial checks	8
3.2.	Instrument power supply	8
3.3.	Calibration	8
3.4.	Storage	8
4.	OPERATING INSTRUCTIONS	9
4.1.	Instrument description	9
4.1.1.	Description of the controls	9
4.1.2.	Alignment marks	9
4.1.3.	Hand protection	10
4.1.4.	Indication of the conventional direction of Current	10
4.2.	Description of the keys	10
4.2.1.	Keys F1 – F2 – F3 – F4	10
4.2.2.	Key H	10
4.2.3.	Key 	10
4.3.	Initial screen	11
5.	INSTRUMENT FUNCTIONS	12
5.1.	Phase detection	12
5.2.	“Settings” position: Instrument settings	12
5.2.1.	General	12
5.2.2.	Date/Time	12
5.2.3.	Log	13
5.2.4.	InRush	13
5.2.5.	Continuity	13
5.3.	Position “  ”: DC, AC+DC voltage measurement and phase sequence verification	14
5.3.1.	DC voltage measurement	14
5.3.1.1.	Key F4 “Fnz”	15
5.3.1.2.	Hold	15
5.3.1.3.	Backlight	15
5.3.2.	AC+DC voltage and Voltage Harmonics measurement	16
5.3.2.1.	Key F2 “Par”	16
5.3.2.2.	AC+DC voltage	16
5.3.2.2.1.	Key F4 “Fnz” in AC+DC voltage measurement	17
5.3.2.3.	Voltage harmonics	17
5.3.2.3.1.	Key F4 “Fnz” in Voltage Harmonics measurement	17
5.3.2.4.	Hold	18
5.3.2.5.	Backlight	18
5.3.3.	Checking phase sequence and phase concordance with a lead	19
5.3.3.1.	Verification of Phase Sequence	19
5.3.3.2.	Verification of Phase Concordance	21
5.4.	Position “  ”: DC, AC+DC current measurement	23
5.4.1.	DC current measurement	23
5.4.1.1.	Key F4 “Fnz”	24
5.4.1.2.	Hold	24
5.4.1.3.	Backlight	24
5.4.2.	AC+DC current and Current Harmonics measurement	25
5.4.2.1.	Key F2 “Par”	25
5.4.2.2.	AC+DC current	25
5.4.2.2.1.	Key F4 “Fnz” in AC+DC current measurement	26
5.4.2.3.	Current harmonics	26
5.4.2.3.1.	Key F4 “Fnz” in Current Harmonics measurement	26
5.4.2.4.	Hold	27
5.4.2.5.	Backlight	27

5.5.	Position “W \approx ” : DC, AC+DC power measurement.....	28
5.5.1.	DC power measurement	29
5.5.1.1.	Key F2 “Par”	29
5.5.1.2.	DC power.....	30
5.5.1.2.1.	Key F4 “Fnz” in DC Power measurement	30
5.5.1.3.	DC voltage and current.....	30
5.5.1.3.1.	Key F4 “Fnz” in DC Voltage and Current measurement.....	31
5.5.1.4.	DC Energy	31
5.5.1.5.	Hold	31
5.5.1.6.	Backlight	31
5.5.2.	Measurement of AC 1P or AC 3P Powers	32
5.5.2.1.	Key F2 “Par”	32
5.5.2.2.	AC+DC power.....	33
5.5.2.3.	Pf and dPf	33
5.5.2.3.1.	Key F4 “Fnz” in Power or Pf-dPf measurement	33
5.5.2.4.	AC+DC Voltage and Current.....	34
5.5.2.4.1.	Key F4 “Fnz” in AC Voltage and Current measurement.....	34
5.5.2.5.	Voltage harmonics	35
5.5.2.6.	Current harmonics	35
5.5.2.6.1.	Key F4 “Fnz” in Voltage and Current Harmonics measurement.....	35
5.5.2.7.	AC Energy	36
5.5.2.8.	Hold	36
5.5.2.9.	Backlight	36
5.6.	Position “W \approx ” : Log, On-Line Scope, SnapShot, Memory, Download	37
5.6.1.	Key F3 “Sys”.....	37
5.6.1.1.	“Start Log” recording.....	37
5.6.1.2.	On-line	38
5.6.1.3.	Memory.....	39
5.6.1.4.	SnapShot.....	39
5.6.1.5.	Download.....	40
5.7.	Position “ Ω ” : Resistance and continuity measurement	41
5.7.1.	Key F4 “Fnz”.....	42
5.7.1.1.	Hold	42
5.7.1.2.	Backlight	42
5.8.	Position “InRush A \approx ” : inrush current measurement	43
5.8.1.	Virtual key “Zero”.....	44
5.8.2.	Key F3 “Run”.....	44
5.8.3.	Key F4 “Mem”.....	44
6.	MAINTENANCE	46
6.1.	General information.....	46
6.2.	Battery replacement	46
6.3.	Cleaning the instrument	46
6.4.	End of life	46
7.	TECHNICAL SPECIFICATIONS.....	47
7.1.	Technical characteristics.....	47
7.1.1.	Safety standards	49
7.1.2.	General characteristics.....	49
7.2.	ENVIRONMENT.....	49
7.2.1.	Environmental conditions for use	49
7.3.	Accessories provided	49
8.	SERVICE	50
8.1.	Warranty conditions.....	50
8.2.	Service	50
9.	APPENDIX – THEORETICAL OUTLINE	51
9.1.	Calculation of powers in “AC 1P” mode	51
9.2.	Calculation of powers in “AC 3P” mode	51
9.3.	Calculation of powers in “DC” mode	51
9.4.	voltage and current harmonics.....	52
9.5.	Limit values for harmonics	53
9.6.	Causes of the presence of harmonics.....	53
9.7.	Consequence of the presence of harmonics	54

1. PRECAUTIONS AND SAFETY MEASURES

The instrument has been designed in compliance with directive IEC/EN61010-1 relevant to electronic measuring instruments. For your safety and in order to prevent damaging the instrument, please carefully follow the procedures described in this manual and read all notes preceded by the symbol  with the utmost attention.

Before and after carrying out the measurements, carefully observe the following instructions:

- Do not carry out any voltage or current measurement in humid environments.
- Do not carry out any measurements in case gas, explosive materials or flammables are present, or in dusty environments.
- Avoid contact with the circuit being measured if no measurements are being carried out.
- Avoid contact with exposed metal parts, with unused measuring probes, circuits, etc.
- Do not carry out any measurement in case you find anomalies in the instrument such as deformation, breaks, substance leaks, absence of display on the screen, etc.
- Pay special attention when measuring voltages higher than 20V, since a risk of electrical shock exists.

In this manual, and on the instrument, the following symbols are used:



Warning: observe the instructions given in this manual; an improper use could damage the instrument or its components.



High voltage danger: electrical shock hazard.



Double-insulated meter



AC voltage or current



DC voltage or current



Connection to earth

1.1. PRELIMINARY INSTRUCTIONS

- This clamp has been designed for use in environments of pollution degree 2.
- It can be used for **CURRENT** and **VOLTAGE** measurements on installations with measurement category CAT IV 600V and CAT III 1000V. For a definition of measurement categories, see § 1.4.
- We recommend following the normal safety rules devised by the procedures for carrying out operations on live systems and using the prescribed PPE to protect the user against dangerous currents and the instrument against incorrect use.
- Only the leads supplied with the instrument guarantee compliance with the safety standards. They must be in good conditions and replaced with identical models, when necessary.
- In case the lack of warning against the presence of voltage may constitute a danger for the operator:
 1. always carry out a continuity measurement before carrying out the measurement of the live system to confirm the correct connection and condition of the leads;
 2. before carrying out the critical measurement, carry out a measurement at a power socket where voltage is surely present. As an alternative, make this verification at your site before going to the unknown measuring point.
- Do not test circuits exceeding the specified current and voltage limits.
- Check that the battery is correctly inserted.
- Before connecting the test leads to the circuit to be tested, make sure that the switch is correctly set.
- Make sure that the LCD display and the switch indicate the same function.

1.2. DURING USE

Please carefully read the following recommendations and instructions:



WARNING

Failure to comply with the Caution notes and/or Instructions may damage the instrument and/or its components or be a source of danger for the operator.

- Before activating the switch, remove the conductor from the clamp jaw or disconnect the test leads from the circuit under test.
- When the instrument is connected to the circuit under test, do not touch any unused terminal.
- Keep your hands always under the hand protection. This protection is always located in a suitable position to guarantee a correct safety distance from possible exposed or live parts (see Fig. 3: hand protection)
- Avoid measuring resistance if external voltages are present. Even if the instrument is protected, excessive voltage could cause a malfunction of the clamp.
- During current measurement, any other current near the clamp may affect measurement precision.
- When measuring current, always put the conductor as near as possible to the middle of the clamp jaw, to obtain the most accurate reading.
- While measuring, if the value or the sign of the quantity being measured remain unchanged, check if the HOLD function is enabled.

1.3. AFTER USE

- When measurement is complete, switch OFF the instrument.
- If the instrument is not to be used for a long time, remove the batteries.

1.4. DEFINITION OF MEASUREMENT (OVERVOLTAGE) CATEGORY

Standard CEI 61010: Safety requirements for electrical equipment for measurement, control and laboratory use, Part 1: General requirements” defines what measurement category, commonly called overvoltage category, is. In § 6.7.4: Measured circuits, circuits are divided into the following measurement categories:

(OMISSIS)

- **Measurement category IV** is for measurements performed at the source of the low-voltage installation.
Examples are electricity meters and measurements on primary overcurrent protection devices and ripple control units.
- **Measurement category III** is for measurements performed on installations inside buildings.
Examples are measurements on distribution boards, circuit breakers, wiring, including cables, bus-bars, junction boxes, switches, socket-outlets in the fixed installation, and equipment for industrial use and some other equipment, for example, stationary motors with permanent connection to fixed installation.
- **Measurement category II** is for measurements performed on circuits directly connected to the low-voltage installation.
Examples are measurements on household appliances, portable tools and similar equipment.
- **Measurement category I** is for measurements performed on circuits not directly connected to MAINS.
Examples are measurements on circuits not derived from MAINS, and specially protected (internal) MAINS-derived circuits. In the latter case, transient stresses are variable; for that reason, the standard requires that the transient withstand capability of the equipment is made known to the user.

2. GENERAL DESCRIPTION

The clamp meter HT9022 carries out the following measurements:

- DC voltage and AC+CD TRMS voltage
- DC current and AC+CD TRMS current
- Phase sequence
- Active, reactive, apparent power and power factor on single-phase and/or balanced three phase systems
- Active, reactive, apparent energy on single-phase and/or balanced three-phase systems
- AC voltage harmonics (1st – 25th) and THD% up to 75Hz (1st – 8th above 75Hz)
- AC current harmonics (1st – 25th) and THD% up to 75Hz (1st – 8th above 75Hz)
- DC power
- Frequency on voltage (leads) and current (clamp jaw)
- Resistance and continuity test with buzzer
- Electric motor starting currents (INRUSH)
- Detection of presence of AC voltage with and without contact with in-built sensor in the clamp jaw

Each of these functions can be selected using the 7-position selector switch, including an OFF position.

Keys **F1**, **F2**, **F3**, **F4** e **H** /  are also provided; for their use, please refer to § 4.2.

2.1. MEASURING AVERAGE VALUES AND TRMS VALUES

Measuring instruments of alternating quantities are divided into two big families:

- AVERAGE-VALUE meters: instruments measuring the value of the sole wave at fundamental frequency from 10 to 400Hz
- TRMS (True Root Mean Square) VALUE meters: instruments measuring the TRMS value of the quantity being tested.

In the presence of a perfectly sinusoidal wave, the two families of instruments provide identical results. In the presence of distorted waves, instead, the readings shall differ. Average-value meters provide the RMS value of the sole fundamental wave, TRSM meters, instead, provide the RMS value of the whole wave, including harmonics (within the instrument's bandwidth). Therefore, by measuring the same quantity with instruments from both families, the values obtained are identical only if the wave is perfectly sinusoidal. In case it is distorted, TRMS meters shall provide higher values than the values read by average-value meters.

2.2. DEFINITION OF TRUE ROOT MEAN SQUARE VALUE AND CREST FACTOR

The root mean square value of current is defined as follows: "*In a time equal to a period, an alternating current with a root mean square value of the intensity of 1A, circulating on a resistor, dissipates the same energy that, during the same time, would have been dissipated by a direct current with the intensity of 1A*". This definition results in the numeric expression:

$$G = \sqrt{\frac{1}{T} \int_{t_0}^{t_0+T} g^2(t) dt}$$

The *root mean square value* is indicated with the acronym RMS.

The Crest Factor is defined as the relationship between the Peak Value of a signal and its

$$\text{RMS value: CF (G)} = \frac{G_p}{G_{RMS}}$$

This value changes with the signal waveform, for a purely sinusoidal wave it is

$$\sqrt{2} = 1.41.$$

In case of distortion, the Crest Factor takes higher values as wave distortion increases.

2.3. HARMONICS

See Appendix (Par.9.4)

3. PREPARATION FOR USE

3.1. INITIAL CHECKS

Before shipping, the instrument has been checked from an electric as well as mechanical point of view. All possible precautions have been taken so that the instrument is delivered undamaged.

However, we recommend generally checking the instrument in order to detect possible damage suffered during transport. In case anomalies are found, immediately contact the forwarding agent.

We also recommend checking that the packaging contains all components indicated in paragraph 7.3. In case of discrepancy, please contact the Dealer.

In case the instrument should be replaced, please carefully follow the instructions given in chapter 8.2.

3.2. INSTRUMENT POWER SUPPLY

The instrument is supplied by two 1.5V LR03 AAA UM-4 batteries. Battery charge duration is approximately 54 hours of continuous use in Power mode (selector switch to “W_≡”).

Replace them following the instructions in paragraph 5.2.

3.3. CALIBRATION

The instrument has the technical specifications described in this manual. The instrument's performance is guaranteed for one year.

3.4. STORAGE

In order to guarantee precise measurement, after a long storage time under extreme environmental conditions, wait for the instrument to come back to normal condition (see the environmental specifications contained in 6.2.1 before use).

4. OPERATING INSTRUCTIONS

4.1. INSTRUMENT DESCRIPTION

4.1.1. Description of the controls

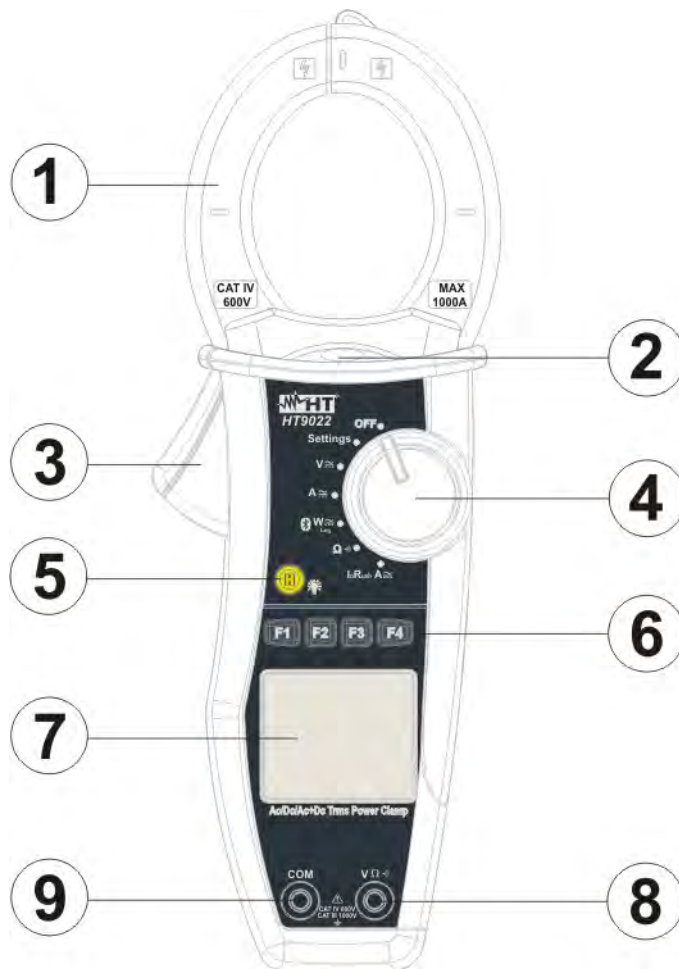

CAPTION:

1. Inductive clamp jaw
2. AC voltage indicator LED
3. Jaw trigger
4. Rotary selector switch
5. Key **H** / backlight
6. Function keys **F1** – **F2** – **F3** – **F4**
7. LCD display
8. Input terminal **VΩ**
9. Input terminal **COM**

Fig. 1: Instrument description

4.1.2. Alignment marks

Put the conductor as close as possible to the middle of the jaws on the intersection of the indicated marks (see Fig. 2) in order to meet the meter accuracy specifications.

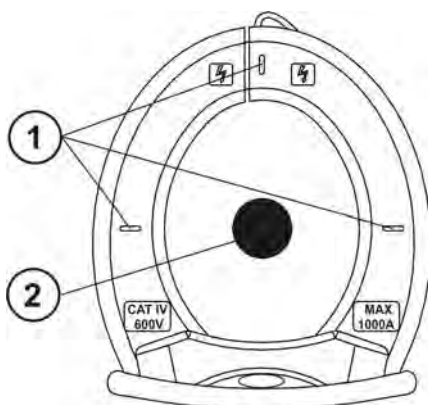

Fig. 2: alignment marks

CAPTION:

1. Alignment marks
2. Conductor

4.1.3. Hand protection

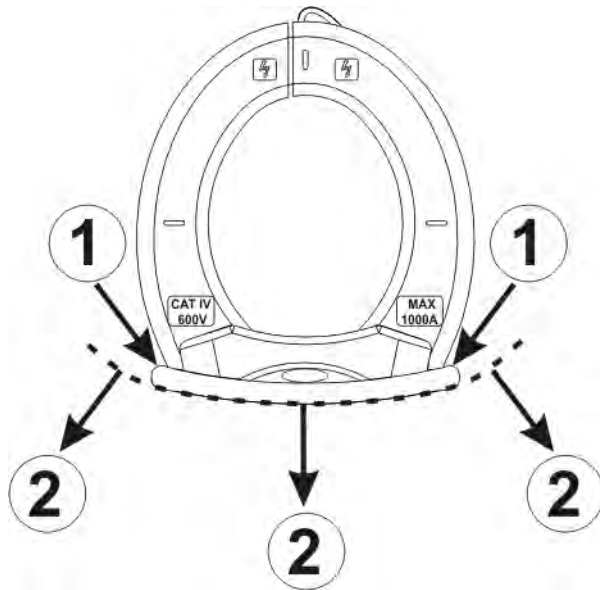

Fig. 3: hand protection

Always keep your hands under the hand protection. This protection is always located in a suitable position to guarantee a correct safety distance from possible exposed or live parts (see Fig. 3)

CAPTION:

1. Hand protection
2. Safe area

4.1.4. Indication of the conventional direction of Current



Fig. 4: current direction arrow

The photo in Fig. 4: current direction arrow shows an arrow which indicates the conventional direction of current.

4.2. DESCRIPTION OF THE KEYS

4.2.1. Keys F1 – F2 – F3 – F4

Keys F1 - F2 - F3 - F4 take different functions according to the measure set (for detailed information, see the single functions).

4.2.2. Key H

Short pressing key “H” activates the function Data HOLD, i.e. the value of the measures quantity is frozen. The symbol  is displayed when this function is enabled.

This operating mode is disabled when key “H” is pressed again or the switch is operated.

4.2.3. Key

To improve the readability of the values measured in dark places, the display has been provided with a backlighting function (backlight), which is turned on and off by long-pressing key “H”. This function automatically deactivates after approximately 10 seconds after being activated, in order not to discharge the battery.

4.3. INITIAL SCREEN

When switching on the instrument, the initial screen appears for a few seconds. It shows:

- the instrument model;
- the serial number of the instrument;
- the firmware version in the instrument's memory.

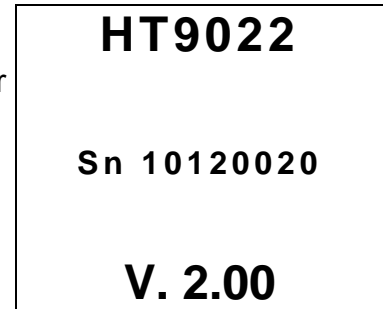

WARNING

Please note down this information, especially the firmware version, in case it should be necessary to contact the Service Department.

After a few seconds, the instrument switches to the selected function.

5. INSTRUMENT FUNCTIONS

5.1. PHASE DETECTION

With the selector switch set to “V \approx ” (Voltage measurement) or “A \approx ” (Current measurement), by taking the end of the clamp jaw near an AC source, the red LED at the base of the clamp jaw will turn on (see Fig. 1 – part 2), which indicates that current is present.



WARNING

Phase detection is not active when the clamp selector switch is set to “OFF”, “SETTINGS”, “W \approx ”, “ Ω ”), “InRush A \approx ”.

5.2. “SETTINGS” POSITION: INSTRUMENT SETTINGS

By positioning the selector switch to “Settings”, the screen aside will appear, containing the possible settings of the instrument. Press keys **F2**, **F3** (\blacktriangledown , \blacktriangle) to move the cursor and key **F4** (**OK**) to confirm the selected item.

	\blacktriangledown	\blacktriangle	OK
General			
Date/Time			
Log			
InRush			
Continuity			
19/01-17:00:00			

5.2.1. General

By selecting “General”, the screen to the side will appear. Press key **F1** (**Sel**) to move the cursor and keys **F2**, **F3** (\blacktriangledown , \blacktriangle) to change the selected item. Press key **F4** (**OK**) to save the changes made and go back to the previous screen (see par.5.2).

- **Language:** the language of the clamp may be chosen among: Italian, English, Spanish. German, Swedish, Danish, Norwegian, French, Dutch, Portuguese, Finnish and Polish.

Sel	\blacktriangledown	\blacktriangle	OK
Language:			
Italian			
Auto-Off:			
OFF			
19/01-17:00:00			

- **Auto-Off:** the auto power off of the clamp may be set to ON or OFF. If set to ON, the clamp will switch off after 5 minutes after it is last used.

5.2.2. Date/Time

By selecting “Date/Time”, the screen to the side will appear. Press key **F1** (**Sel**) to move the cursor and keys **F2**, **F3** (\blacktriangledown , \blacktriangle) to change the selected item. Item “Format” allows selecting the date and time format between EU (European) or USA (American). Press key **F4** (**OK**) to save the changes made and go back to the previous screen (see par.5.2).

Sel	\blacktriangledown	\blacktriangle	OK
Year:		11	
Month:		01	
Day:		19	
Hour:		17	
Minute:		00	
Format:		EU	
19/01-17:00:00			

5.2.3. Log

By selecting “**Log**”, the screen to the side will appear.
 Press keys **F2, F3** (▼, ▲) to change the duration of the integration period. It will take the following values:
 1, 5, 10, 30, 60, 120, 300, 600 or 900 seconds.
 Press key **F4 (OK)** to save the changes made and go back to the previous screen (see par.5.2).

	▼	▲	OK
Int. Period:			
001		s	
19/01-17:00:00			█

5.2.4. InRush

By selecting “**InRush**”, the screen to the side will appear.
 Press key **F1 (Sel)** to move the cursor and keys **F2, F3** (▼, ▲) to change the selected item.
 Press key **F4 (OK)** to save the changes made and go back to the previous screen (see par.5.2).

Sel	▼	▲	OK
Thres: 080			
Window: 1 / 1			
Mode: Fix			
19/01-17:00:00			█

- **Thresh:** threshold value beyond which the inrush current event is detected and recorded by the instrument. The current value may be set between 5A and 900A in steps of 1A.
- **Window:** the value of the inrush current measuring window. The following values are available:
 - **1/1:** sampling occurs every half-period;
 - **1/2:** sampling occurs one every two half-periods;
 - **1/4:** sampling occurs one every four half-periods;
- **Mode:** the inrush current measuring mode. Following modes are available:
 - Fix;
 - Var.

For details about the measurement of Inrush Currents see par. 5.8.2.

5.2.5. Continuity

By selecting “**Continuity**”, the screen to the side will appear.
 Press keys **F2, F3** (▼, ▲) to change the setting of the resistance limit value below which the buzzer will sound. It may be set between 1Ω and 150Ω in steps of 1Ω.
 Press key **F4 (OK)** to save the changes made and go back to the previous screen (see par.5.2).

Sel	▼	▲	OK
Res Lim:			
010		Ω	
19/01-17:00:00			█

5.3. POSITION “V \approx ”: DC, AC+DC VOLTAGE MEASUREMENT AND PHASE SEQUENCE VERIFICATION



WARNING

The maximum DC or AC+DC input voltage is 1000V. When the display shows “> 999.9V”, it means that the maximum value the clamp is able to measure has been exceeded. Exceeding these limits could result in electrical shocks to the user and damage to the instrument.

By positioning the selector switch to “V \approx ”, the screen to the side will appear.

Mod	Par	Fnz
AC	< 10.0	Hz
	- - - -	V
19/01-17:00:00		

Press key **F1 (Mod)** to open the drop-down menu shown on the screen to the side. At each subsequent pressure of key **F1**, the cursor will scroll through the available items, as follows:

- **AC**: AC+DC voltage measurement;
- **DC**: DC voltage measurement;
- **Ph Seq**: verification of phase sequence;
- **Help**: it displays the connection diagram of the instrument to the system;

Mod	Par	OK
AC	< 10.0	Hz
DC		
Ph Seq		
Help	- -	V
Esc		
19/01-17:00:00		

Select the desired mode and press key **F4 (OK)** to confirm.

5.3.1. DC voltage measurement



Fig. 5: DC voltage measurement

Insert the red cable into the input lead **VΩ[Ⓜ]**) and the black cable into the input lead **COM** (Fig. 5), and position the leads to the desired points of the circuit being tested.

The screen shows an example of DC Voltage measurement.

Mod	Par		Fnz
	DC		
	12.0		V
19/01-17:00:00			

5.3.1.1. Key F4 “Fnz”

Press key **F4 (Fnz)** to open the drop-down menu shown on the screen to the side. At each subsequent pressure of key **F4**, the cursor will scroll through the available items, as follows:

- **Max**: it constantly displays the maximum value of the measured DC Voltage;
- **Min**: it constantly displays the minimum value of the measured DC Voltage;
- **Cr+**: it constantly displays the maximum positive crest value;
- **Cr-**: it constantly displays the minimum negative crest value;
- **Rst**: it deletes all stored Max, Min, Cr+ and Cr- values;
- **Esc**: it goes back to a normal measuring mode.

Mod	Par	OK	Fnz
	DC		Max
	12.0		Min
			Cr+
			Cr-
			Rst
			Esc
19/01-17:00:00			



WARNING

Note: the measurement of the 4 Max, Min, Cr+ and Cr- values is simultaneous, regardless of the one displayed.

By pressing key **F3 (OK)**, the selected item is confirmed. To the side, an example of measurement with active Max function.

The display shows the active function.

Mod	Par		Fnz
Max	DC		
	12.0		V
19/01-17:00:00			

5.3.1.2. Hold

Short pressing key **“H”** activates the function Data HOLD. The display shows the message and the screen of the measurement in progress is “frozen”.

This operating mode is deactivated when key **“H”** is pressed again or the switch is operated.

5.3.1.3. Backlight

Long pressing key **“H”** activates or deactivates the display backlight. This function automatically deactivates after approximately 10 seconds after being activated, in order not to discharge the batteries.

5.3.2. AC+DC voltage and Voltage Harmonics measurement



Fig. 6: AC+DC voltage measurement

Insert the red cable into the input lead **VΩ** and the black cable into the input lead **COM**, and position the leads to the desired points of the circuit being tested (Fig. 6). The voltage and frequency value is shown on the display.

5.3.2.1. Key F2 “Par”

Press key **F2 (Par)** to open the drop-down menu shown on the screen to the side. At each subsequent pressure of key **F2**, the cursor will scroll through the available items, as follows:

- **Voltage**: it shows the measured Voltage value;
- **Voltage Har**: it shows the measured Voltage harmonics;
- **Esc**: it closes the drop-down menu.

Select the desired parameter and press key **F4 (OK)** to confirm.

Mod	Par	OK
	Voltage	
	Voltage Har	
	Esc	
	220.5	V
19/01-17:00:00		

5.3.2.2. AC+DC voltage

The screen shows an example of AC+DC Voltage measurement.

Mod	Par	Fnz
	AC	50.0 Hz
	220.5	V
19/01-17:00:00		

5.3.2.2.1. Key F4 “Fnz” in AC+DC voltage measurement

While measuring AC+DC voltage, press key **F4 (Fnz)** to open the drop-down menu shown on the screen to the side. At each subsequent pressure of key **F4**, the cursor will scroll through the available items, as follows:

- **Max**: it constantly displays the maximum RMS value of Voltage;
- **Min**: it constantly displays the minimum RMS value of Voltage;
- **Cr+**: it constantly displays the maximum positive crest value;
- **Cr-**: it constantly displays the minimum negative crest value;
- **Rst**: it deletes all stored Max, Min, Cr+ and Cr- values;
- **Esc**: it goes back to a normal measuring mode.

Mod	Par	OK	Fnz
	AC	50.0	Max
220.5			Min
			Cr+
			Cr-
			Rst
			Esc
19/01-17:00:00			

By pressing key **F3 (OK)**, the selected item is confirmed. To the side, an example of measurement with active Max function. The display shows the active function.

Mod	Par		Fnz
Max	AC	50.0 Hz	
220.5			V
19/01-17:00:00			

5.3.2.3. Voltage harmonics

The screen shows an example of Voltage Harmonics measurement.

By pressing keys **F1 (◀)** or **F3 (▶)**, it is possible to move the cursor over the graph and to select the harmonic to be measured.

It is possible to measure up to the 25th harmonic, for fundamental frequencies between 10Hz and 75Hz, and up to the 8th harmonic for fundamental frequencies between 75Hz and 400Hz.

◀	Par	▶	Fnz
H01	215.0	V	
ThdV	10.0	%	
19/01-17:00:00			

5.3.2.3.1. Key F4 “Fnz” in Voltage Harmonics measurement

While measuring Voltage Harmonics, press key **F4 (Fnz)** to open the drop-down menu shown on the screen to the side. At each subsequent pressure of key **F4**, the cursor will scroll through the available items, as follows:

- **Max**: it constantly displays the maximum RMS value of the selected current harmonic;
- **Min**: it constantly displays the minimum RMS value of the selected current harmonic;
- **Abs**: it displays the absolute value of the harmonics in Volts;

◀	Par	OK	Fnz
H01	215.0		Max
ThdV	10.0		Min
			Abs
			%
			Rst
			Esc
19/01-17:00:00			

- %: it displays the value of the harmonics as percentage value with respect to the fundamental;
- **Rst**: it deletes all stored Max, Min values;
- **Esc**: it goes back to a normal measuring mode.

Note: since the menu contains functions with a different meaning (Max-Min and Abs-%), it is necessary to enter the menu twice: once for displaying Abs or % values and another time to enable the Max or Min functions.

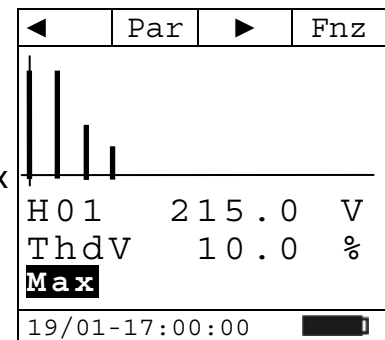

By pressing key **F3 (OK)**, the selected item is confirmed. To the side, an example of measurement with active Max function. The display shows the active function.

5.3.2.4. Hold

Short pressing key "**H**" activates the function Data HOLD. The display shows the message "" and the screen of the measurement in progress is "frozen".

This operating mode is deactivated when key "**H**" is pressed again or the switch is operated.

5.3.2.5. Backlight

Long pressing key "**H**" activates or deactivates the display backlight. This function automatically deactivates after approximately 10 seconds after being activated, in order not to discharge the batteries.

5.3.3. Checking phase sequence and phase concordance with a lead



WARNING

While measuring, the instrument must be held in the operator's hand.

Press key **F1 (Mod)** to open the drop-down menu shown on the screen to the side. At each subsequent pressure of key **F1 (Mod)**, the cursor will scroll through the available items. Select "**Ph Seq**" and press key **F4 (OK)** to confirm the selected item.

Mod	Par	Ok
AC	< 10.0 Hz	
DC		
Ph Seq		
Help	- -	V
Esc		
19/01-17:00:00 █		

5.3.3.1. Verification of Phase Sequence.



Fig. 7: verification of phase sequence

1. The instrument shows the screen here to the side, and waits for the detection of phase L1.
2. Insert the red cable into input terminal $V\Omega\text{A}$ and connect the red lead to phase L1 (Fig. 7).

Mod	Par	Go
Ph Seq		
PH1		
Wait		
19/01-17:00:00 █		

WARNING

If the frequency of the measured voltage is lower than 40Hz or higher than 70Hz, the display shows the message "**F<40 Hz**" or "**F>70 Hz**" and phase detection does not start.

- When a voltage higher than or equal to 100V is detected, the instrument gives an acoustic signal (buzzer) and the message "**Meas**" is shown on the display. Do not press any key and keep the test lead connected to L1 phase cable.

Mod			Go
Ph Seq			
PH1			
Meas			
19/01-17:00:00			

- Once phase L1 acquisition is complete, the displays shows the screen here to the side. Disconnect the test lead from phase L1 cable.

Mod			Go
Ph Seq			
Discon.			
Wait			
19/01-17:00:00			

- The instrument shows the screen here to the side, and waits for the detection of phase L2. Connect the test lead to phase L2 cable.

Mod			Go
Ph Seq			
PH2			
Wait			
19/01-17:00:00			

WARNING

If more than 3 seconds elapse before detecting phase L2, the instrument displays the message "**Time Out**". It is necessary to repeat the measuring cycle from the beginning, by pressing key **F4 (Go)** and starting from step 1 again.

- When a voltage higher than or equal to 100V is detected, the instrument gives an acoustic signal (buzzer) and the message "**Meas**" is shown on the display. Do not press any key and keep the test lead connected to L2 phase cable.

Mod			Go
Ph Seq			
PH2			
Meas			
19/01-17:00:00			

7. If the two phases, to which the test lead has been connected, are in the correct sequence, the instrument displays the screen here to the side. Should the phase sequence be incorrect, the display shows “132”.

To start a new measurement, press key **F4 (Go)**.

Mod			Go
Ph Seq			
1 2 3			
19/01-17:00:00			

5.3.3.2. Verification of Phase Concordance

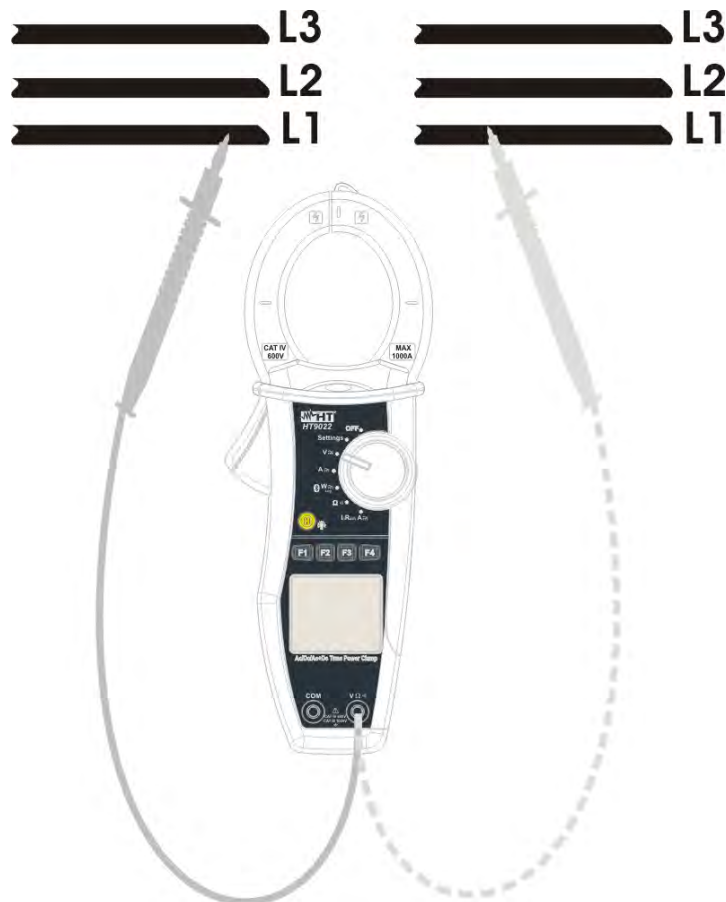
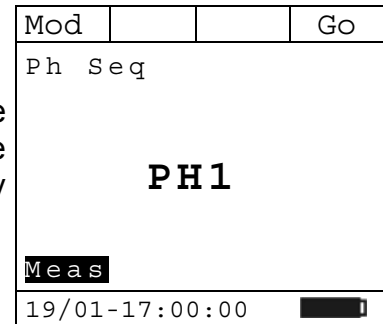

Fig. 8: verification of Phase Concordance

1. The instrument shows the screen here to the side, and waits for the detection of phase L1.
2. Insert the red cable into input terminal $V\Omega$ and connect the red lead to phase L1 of the first sequence (Fig. 8).

Mod			Go
Ph Seq			
PH1			
Wait			
19/01-17:00:00			

3. When a voltage higher than or equal to 100V is detected, the instrument gives an acoustic signal (buzzer) and the message “**Meas**” is shown on the display. Do not press any key and keep the test lead connected to L1 phase cable.



4. Once phase L1 acquisition is complete, the displays shows the screen here to the side. Disconnect the test lead from phase L1 cable.

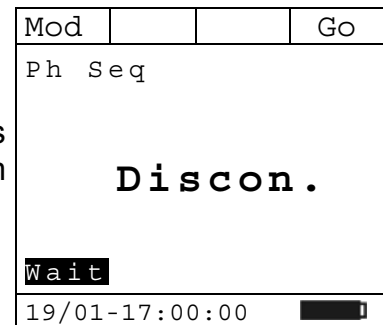

5. The instrument shows the screen here to the side, and waits for the detection of the second sequence of phase L1. Connect the test lead to phase L1 of the second sequence.

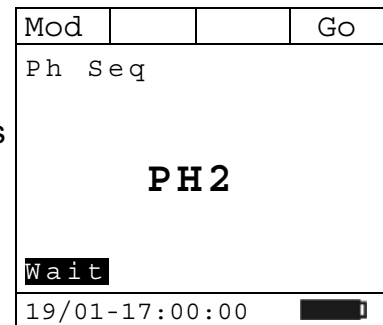

WARNING



If more than 3 seconds elapse before detecting the phase L1 of the second sequence, the instrument displays the message “**Time Out**”. It is necessary to repeat the measuring cycle from the beginning, by pressing key **F4 (Go)** and starting from step 1 again.

6. When a voltage higher than or equal to 100V is detected, the instrument gives an acoustic signal (buzzer) and the message “**Meas**” is shown on the display. Do not press any key and keep the test lead connected to L1 phase cable of the second sequence.

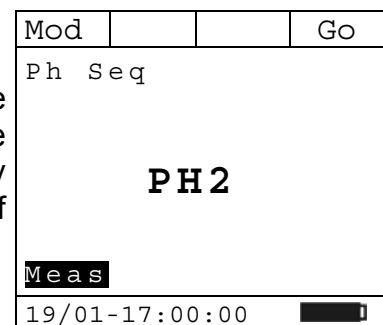

7. If there is concordance between the two phases, to which the test lead has been connected, the instrument displays the screen here to the side. Otherwise, it displays “**123**” or “**132**”.

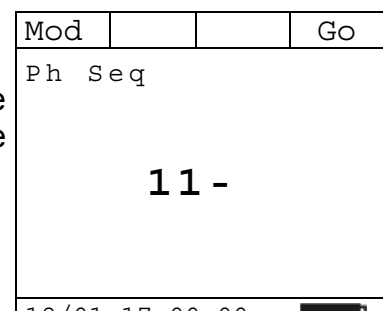

To start a new measurement, press key **F4 (Go)**.

5.4. POSITION “A \approx ”: DC, AC+DC CURRENT MEASUREMENT



WARNING

The maximum measurable DC or AC+DC current is 1000A. When the display shows “> 999.9A”, it means that the maximum value the clamp is able to measure has been exceeded. Exceeding these limits could result in electrical shocks to the user and damage to the instrument. We recommend holding the clamp respecting the safety area created by the hand protection (see Fig. 3)

By positioning the selector switch to “A \approx ”, the screen to the side will appear.

Mod	Par	Fnz
	AC	< 10.0 Hz
	- - - -	A
19/01-17:00:00		

Press key **F1 (Mod)** to open the drop-down menu shown on the screen to the side. At each subsequent pressure of key **F1**, the cursor will scroll through the available items, as follows:

- **AC**: AC+DC voltage measurement;
- **DC**: DC voltage measurement;
- **Help**: it displays the connection between instrument and system;
- **Esc**: it closes the drop-down menu.

Mod	Par	OK
AC	< 10.0 Hz	
DC	- -	A
Help		
Esc		
19/01-17:00:00		

Select the desired mode and press key **F4 (OK)** to confirm.

5.4.1. DC current measurement

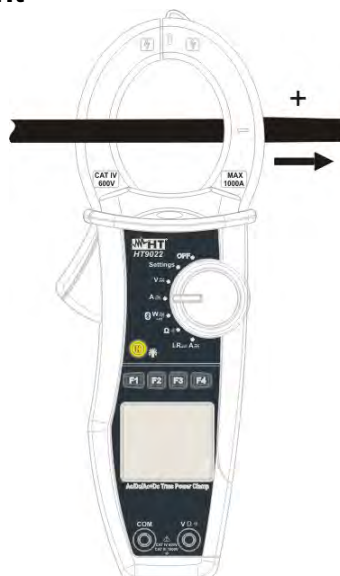

Fig. 9: DC current measurement



WARNING

Insert the cable in the middle of the clamp jaws, in order to obtain accurate measures. Use the marks as a reference (see Fig. 2).

The screen shows an example of DC current measurement.

Mod	Par		Fnz
	DC		
	100.0		A
19/01-17:00:00			

5.4.1.1. Key F4 “Fnz”

Press key **F4 (Fnz)** to open the drop-down menu shown on the screen to the side. At each subsequent pressure of key **F4**, the cursor will scroll through the available items, as follows:

- **Max**: it constantly displays the maximum value of DC current;
- **Min**: it constantly displays the minimum selected value of DC current;
- **Cr+**: it constantly displays the maximum positive crest value;
- **Cr-**: it constantly displays the minimum negative crest value;
- **Zero**: it zeroes the measured DC current;
- **Rst**: it deletes all stored Max, Min, Cr+ and Cr- values;
- **Esc**: it goes back to a normal measuring mode.

Mod	Par	OK	Fnz
	DC		Max
	100.0		Min
			Cr+
			Cr-
			Zero
			Rst
			Esc
19/01-17:00:00			

WARNING



Note:

- carry out current zeroing before clamping the conductor;
- the measurement of the 4 Max, Min, Cr+ and Cr- values is simultaneous, regardless of the one displayed.

By pressing key **F3 (OK)**, the selected item is confirmed. To the side, an example of measurement with active Max function. The display shows the active function.

Mod	Par		Fnz
Max	DC		
	100.0		A
19/01-17:00:00			

5.4.1.2. Hold

Short pressing key “**H**” activates the function Data HOLD. The display shows the message and the screen of the measurement in progress is “frozen”.

This operating mode is deactivated when key “**H**” is pressed again or the switch is operated.

5.4.1.3. Backlight

Long pressing key “**H**” activates or deactivates the display backlight. This function automatically deactivates after approximately 10 seconds after being activated, in order not to discharge the batteries.

5.4.2. AC+DC current and Current Harmonics measurement

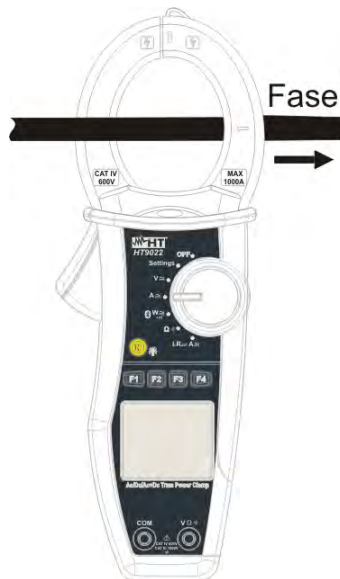

Fig. 10: AC+DC current measurement



WARNING

Insert the cable in the middle of the clamp jaws, in order to obtain accurate measures.

Use the marks as a reference (see Fig. 2).

5.4.2.1. Key F2 “Par”

Press key **F2 (Par)** to open the drop-down menu shown on the screen to the side. At each subsequent pressure of key **F2**, the cursor will scroll through the available items, as follows:

- **Current**: it shows the measured current value;
- **Current Har**: it shows the measured Current harmonics;
- **Esc**: it closes the drop-down menu.

Select the desired parameter and press key **F4 (OK)** to confirm.

Mod	Par		OK
	Current		
	Current Har		
	Esc		
	100.0	A	
19/01-17:00:00			

5.4.2.2. AC+DC current

The screen shows an example of AC+DC current measurement.

Mod	Par		Fnz
	AC	50.0	Hz
	100.0	A	
19/01-17:00:00			

5.4.2.2.1. Key F4 “Fnz” in AC+DC current measurement

While measuring Current, press key **F4 (Fnz)** to open the drop-down menu shown on the screen to the side. At each subsequent pressure of key **F4**, the cursor will scroll through the available items, as follows:

- **Max**: it constantly displays the maximum RMS value of current;
- **Min**: it constantly displays the minimum RMS value of current;
- **Cr+**: it constantly displays the maximum positive crest value;
- **Cr-**: it constantly displays the minimum negative crest value;
- **Zero**: it zeroes the average value of the measured current;
- **Rst**: it deletes all stored Max, Min, Cr+ and Cr- values;
- **Esc**: it goes back to a normal measuring mode.

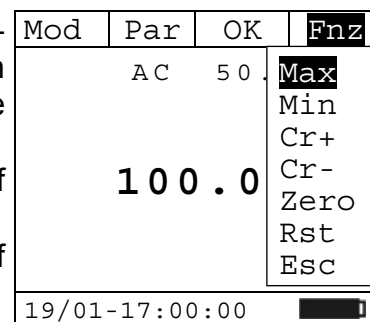

WARNING

Note: carry out current zeroing before clamping the conductor.

By pressing key **F3 (OK)**, the selected item is confirmed. To the side, an example of measurement with active Max function. The display shows the active function.

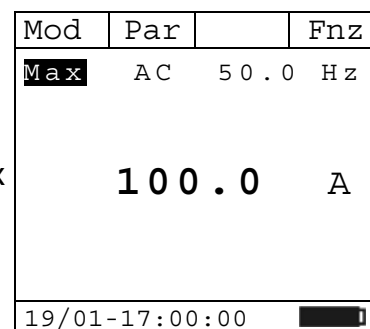

5.4.2.3. Current harmonics

The screen shows an example of Current Harmonics measurement.

By pressing keys **F1 (◀)** or **F3 (▶)**, it is possible to move the cursor over the graph and to select the harmonic to be measured.

It is possible to measure up to the 25th harmonic, for fundamental frequencies between 10Hz and 75Hz, and up to the 8th harmonic for fundamental frequencies between 75Hz and 400Hz.

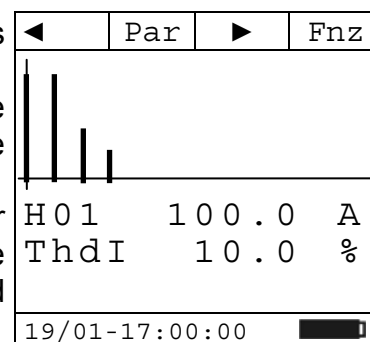

5.4.2.3.1. Key F4 “Fnz” in Current Harmonics measurement

While measuring Current Harmonics, press key **F4 (Fnz)** to open the drop-down menu shown on the screen to the side. At each subsequent pressure of key **F4**, the cursor will scroll through the available items, as follows:

- **Max**: it constantly displays the maximum RMS value of the selected current harmonic;
- **Min**: it constantly displays the minimum RMS value of the selected current harmonic;
- **Abs**: it displays the value of the harmonics in Amperes;

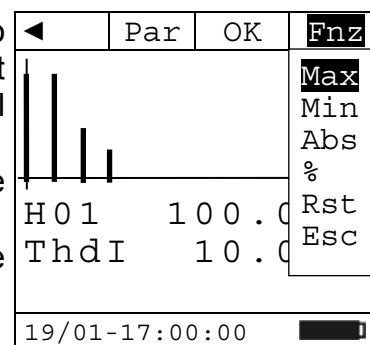

- %: it displays the value of the harmonics as percentage value with respect to the fundamental;
- **Rst**: it deletes all stored Max and Min values;
- **Esc**: it goes back to a normal measuring mode.

Note: since the menu contains functions with a different meaning (Max-Min and Abs-%), it is necessary to enter the menu twice: once for displaying Abs or % values and another time to enable the Max or Min functions.

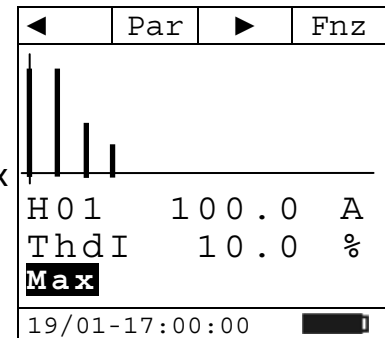

By pressing key **F3 (OK)**, the selected item is confirmed. To the side, an example of measurement with active Max function. The display shows the active function.

5.4.2.4. Hold

Short pressing key "**H**" activates the function Data HOLD. The display shows the message "" and the screen of the measurement in progress is "frozen".

This operating mode is deactivated when key "**H**" is pressed again or the switch is operated.

5.4.2.5. Backlight

Long pressing key "**H**" activates or deactivates the display backlight. This function automatically deactivates after approximately 10 seconds after being activated, in order not to discharge the batteries.

5.5. POSITION “W_≅”: DC, AC+DC POWER MEASUREMENT



WARNING

The maximum DC or AC+DC input voltage is 1000V and the maximum measurable DC or AC+DC current is 1000A. Do not measure voltages and currents exceeding the limits given in this manual. Exceeding these limits could result in electrical shocks to the user and damage to the instrument. We recommend holding the clamp respecting the safety area created by the hand protection (see Fig. 3)

By positioning the selector switch to “W_≅”, the screen to the side will appear.

Mod	Par	Sys	Fnz
	AC	<10.0	Hz
- - - -			kW
- - - -			kV a r i
- - - -			kVA
		1 P	
19/01-17:00:00			

Press key **F1 (Mod)** to open the drop-down menu shown on the screen to the side. At each subsequent pressure of key **F1**, the cursor will scroll through the available items, as follows:

- **AC 1P**: measurement of AC Powers on single-phase system;
- **AC 3P**: measurement of AC Powers on three-phase balanced system;
- **DC**: DC Power measurement;
- **Help**: it displays the connection between instrument and system;
- **Esc**: it closes the drop-down menu.

Mod	Par	Sys	OK
AC	1P	<10.0	Hz
AC	3P		
DC	- -		kW
Help	- -		kV a r i
Esc	- -		kVA
19/01-17:00:00			

Select the desired measuring mode and press key **F4 (OK)** to confirm.

See par.9.1, 9.2 and 9.3 for details about calculation formulas.

5.5.1. DC power measurement



Fig. 11: DC power measurement

Insert the red cable into input lead **VΩ** and the black cable into input lead **COM**.

Position the red lead to “+” and the black lead to “-” and insert the “+” cable into the clamp jaws, respecting the direction of current indicated by the arrow (see Fig. 4)



ATTENZIONE

Insert the cable in the middle of the clamp jaws, in order to obtain accurate measures.
Use the marks as a reference (see Fig. 2).

5.5.1.1. Key F2 “Par”

Press key **F2 (Par)** to open the drop-down menu shown on the screen to the side. At each subsequent pressure of key **F2**, the cursor will scroll through the available items, as follows:

- **Power**: it shows the measured Power value;
- **Volt-Curr**: it displays the measured Voltage and Current values;
- **Energy**: it shows the measured energy value. This measurement is only active when a recording is active (see par. 5.6.1.1).
- **Esc**: it closes the drop-down menu.

Select the desired parameter and press key **F4 (OK)** to confirm.

Mod	Par	Sys	OK
	Power		
	Volt-Curr		
	Energy		
	Esc		k W
19/01-17:00:00			

5.5.1.2. DC power

The screen to the side shows an example of DC power measurement.

Mod	Par	Sys	Fnz
	DC		
	0 . 4 0		k W
19/01-17:00:00 			

5.5.1.2.1. Key F4 “Fnz” in DC Power measurement

While measuring DC Power, press key **F4 (Fnz)** to open the drop-down menu shown on the screen to the side. At each subsequent pressure of key **F4**, the cursor will scroll through the available items, as follows:

- **Max**: it constantly displays the maximum value of the measured parameter;
- **Min**: it constantly displays the minimum value of the measured parameter;
- **Rst**: it deletes all stored Max and Min values;
- **Esc**: it goes back to a normal measuring mode.

Mod	Par	OK	Fnz
	DC		
	0 . 4 0		Max Min Rst Esc
19/01-17:00:00 			

By pressing key **F3 (OK)**, the selected item is confirmed. To the side, an example of measurement with active Max function. The display shows the active function.

Mod	Par	Sys	Fnz
Max	DC		
	0 . 4 0		k W
19/01-17:00:00 			

5.5.1.3. DC voltage and current

The screen shows an example of DC Voltage and Current measurement.

Mod	Par	Sys	Fnz
	DC		
	8 0 . 0		V
	2 0 . 0		A
19/01-17:00:00 			

5.5.1.3.1. Key F4 “Fnz” in DC Voltage and Current measurement

While measuring Voltage and Current, press key **F4 (Fnz)** to open the drop-down menu shown on the screen to the side. At each subsequent pressure of key **F4**, the cursor will scroll through the available items, as follows:

- **Max**: it constantly displays the maximum value of the measured parameter;
- **Min**: it constantly displays the minimum value of the measured parameter;
- **Cr+**: it constantly displays the maximum positive crest value measured;
- **Cr-**: it constantly displays the minimum negative crest value measured;
- **Zero**: it zeroes the measured DC current;
- **Rst**: it deletes all stored Max, Min, Cr+ and Cr- values;
- **Esc**: it goes back to a normal measuring mode.

Mod	Par	OK	Fnz
	DC		Max
			Min
	80.0		Cr+
	20.0		Cr-
			Zero
			Rst
			Esc
19/01-17:00:00			



WARNING

Note: carry out current zeroing before clamping the conductor.

By pressing key **F3 (OK)**, the selected item is confirmed. To the side, an example of measurement with active Max function. The display shows the active function.

Mod	Par	Sys	Fnz
Max	DC		
	80.0		V
	20.0		A
19/01-17:00:00			

5.5.1.4. DC Energy

The screen shows an example of DC Energy measurement.

Mod	Par	Sys	Fnz
	DC		
	2.20		kWh
			Log
19/01-17:00:00			

5.5.1.5. Hold

Short pressing key “**H**” activates the function Data HOLD. The display shows the message and the screen of the measurement in progress is “frozen”.

This operating mode is deactivated when key “**H**” is pressed again or the switch is operated.

5.5.1.6. Backlight

Long pressing key “**H**” activates or deactivates the display backlight. This function automatically deactivates after approximately 10 seconds after being activated, in order not to discharge the batteries.

5.5.2. Measurement of AC 1P or AC 3P Powers

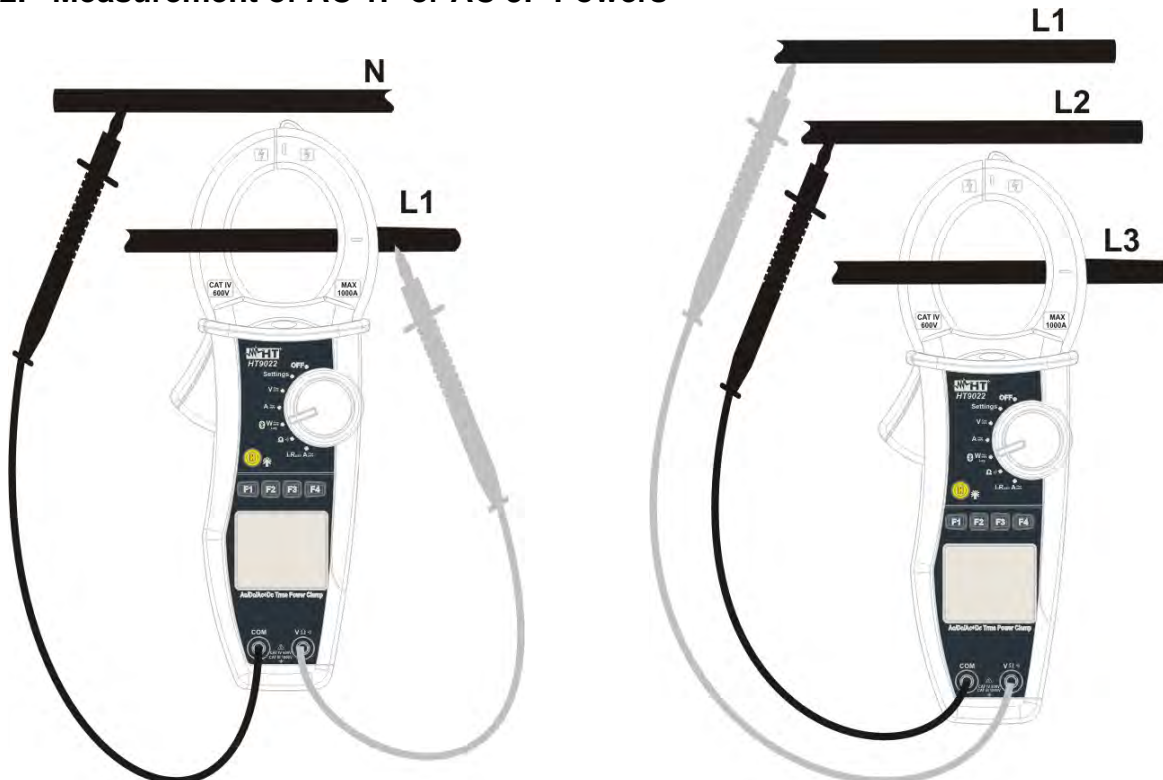

Fig. 12: measurement of AC 1P or AC 3P Powers

Insert the red cable into the input lead **VΩ μ**) and the black cable into the input lead **COM**, and connect the instrument as described in Fig. 12.



WARNING

Insert the cable in the middle of the clamp jaws, in order to obtain accurate measures.
Use the marks as a reference (see Fig. 2).

5.5.2.1. Key F2 “Par”

Press key **F2 (Par)** to open the drop-down menu shown on the screen to the side. At each subsequent pressure of key **F2**, the cursor will scroll through the available items, as follows:

- **P-Q-S**: it displays the measured values of Active, Reactive and Apparent Power;
- **Pf-dPf**: it displays the measured values of Power Factor and Cosphi;
- **Voltage Harm**: it shows the measured Voltage Harmonics;
- **Current Harm**: it shows the measured Current Harmonics;

Mod	Par	Sys	OK
	P-Q-S		
	Pf-dPf		
--	Volt-Curr		
--	Voltage Har		
--	Current Har		
--	Energy		
	Esc		
19/01-17:00:00			

- **Energy**: it shows the measured energy value. This measurement is only active when a recording is active (see par. 5.6.1.1).
- **Esc**: it closes the drop-down menu.

Select the desired parameter and press key **F4 (OK)** to confirm.

5.5.2.2. AC+DC power

The screen shows an example of AC+DC Power measurement.

Mod	Par	Sys	Fnz
	AC	50.0	Hz
	21.47		kW
	7.68		kVari
	22.90		kVA
		1P	
19/01-17:00:00			

5.5.2.3. Pf and dPf

The screen shows an example of Power Factor and Cosphi measurement.

Mod	Par	Sys	Fnz
	AC	50.0	Hz
	Pf	0.94	i
	dPf	0.94	i
		1P	
19/01-17:00:00			

5.5.2.3.1. Key F4 “Fnz” in Power or Pf-dPf measurement

While measuring Power or Pf-dPf, press key **F4 (Fnz)** to open the drop-down menu shown on the screen to the side. At each subsequent pressure of key **F4**, the cursor will scroll through the available items, as follows:

- **Max**: it constantly displays the maximum value of the measured parameter;
- **Min**: it constantly displays the minimum value of the measured parameter;
- **Rst**: it deletes all stored Max and Min values;
- **Esc**: it goes back to a normal measuring mode.

Mod	Par	OK	Fnz
	AC	50.	Max
	21.47		Min
	7.68		Rst
	22.90		Esc
			kVA
19/01-17:00:00			

By pressing key **F3 (OK)**, the selected item is confirmed.

To the side, an example of measurement with active Max function. The display shows the active function.

Mod	Par	Sys	Fnz
Max	AC	50.0	Hz
	21.47		kW
	7.68		kVari
	22.90		kVA
		1P	
19/01-17:00:00			

5.5.2.4. AC+DC Voltage and Current

The screen shows an example of AC+DC Voltage and Current measurement.

Mod	Par	Sys	Fnz
	AC	50.0	Hz
		229.7	V
		99.6	A
		1P	
19/01-17:00:00			

5.5.2.4.1. Key F4 “Fnz” in AC Voltage and Current measurement

While measuring Voltage and Current, press key **F4 (Fnz)** to open the drop-down menu shown on the screen to the side. At each subsequent pressure of key **F4**, the cursor will scroll through the available items, as follows:

- **Max**: it constantly displays the maximum value of the measured parameter;
- **Min**: it constantly displays the minimum value of the measured parameter;
- **Cr+**: it constantly displays the maximum positive crest value measured;
- **Cr-**: it constantly displays the minimum negative crest value measured;
- **Zero**: it zeroes the average value of the measured current;
- **Rst**: it deletes all stored Max, Min, Cr+ and Cr- values;
- **Esc**: it goes back to a normal measuring mode.

Mod	Par	OK	Fnz
	AC	50	Max
		229.7	Min
		99.6	Cr+
			Cr-
			Zero
			Rst
			Esc
19/01-17:00:00			



WARNING

Note: carry out current zeroing before clamping the conductor.

By pressing key **F3 (OK)**, the selected item is confirmed. To the side, an example of measurement with active Max function. The display shows the active function.

Mod	Par	Sys	Fnz
Max	AC	50.0	Hz
		229.7	V
		99.6	A
		1P	
19/01-17:00:00			

5.5.2.5. Voltage harmonics

The screen shows an example of Voltage Harmonics measurement.

By pressing keys **F1** (◀) or **F3** (▶), it is possible to move the cursor over the graph and to select the harmonic to be measured.

It is possible to measure up to the 25th harmonic, for fundamental frequencies between 10Hz and 75Hz, and up to the 8th harmonic for fundamental frequencies between 75Hz and 400Hz.

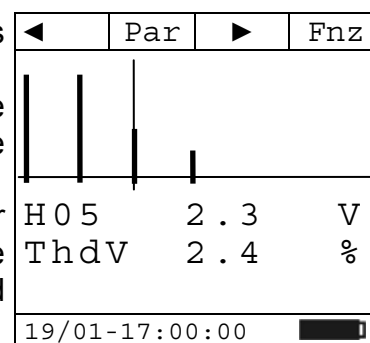

5.5.2.6. Current harmonics

The screen shows an example of Current Harmonics measurement.

By pressing keys **F1** (◀) or **F3** (▶), it is possible to move the cursor over the graph and to select the harmonic to be measured.

It is possible to measure up to the 25th harmonic, for fundamental frequencies between 10Hz and 75Hz, and up to the 8th harmonic for fundamental frequencies between 75Hz and 400Hz.

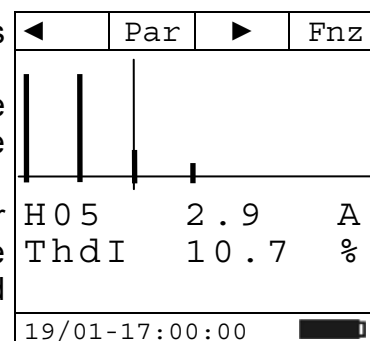

5.5.2.6.1. Key F4 “Fnz” in Voltage and Current Harmonics measurement

While measuring Voltage or Current Harmonics, press key **F4** (**Fnz**) to open the drop-down menu shown on the screen to the side. At each subsequent pressure of key **F4**, the cursor will scroll through the available items, as follows:

- **Max**: it constantly displays the maximum RMS value of the selected current or voltage harmonic;
- **Min**: it constantly displays the minimum RMS value of the selected current or voltage harmonic;
- **Abs**: it displays the value of the harmonics in Amperes or Volts;
- **%**: it displays the value of the harmonics as percentage value with respect to the fundamental;
- **Rst**: it deletes all stored Max and Min values;
- **Esc**: it goes back to a normal measuring mode.

Note: since the menu contains functions with a different meaning (Max-Min and Abs-%), it is necessary to enter the menu twice: once for displaying Abs or % values and another time to enable the Max or Min functions.

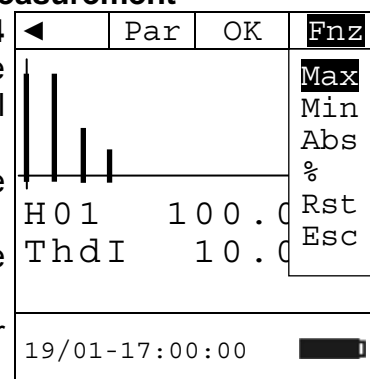

By pressing key **F3** (**OK**), the selected item is confirmed.

To the side, an example of measurement with active Max function. The display shows the active function.

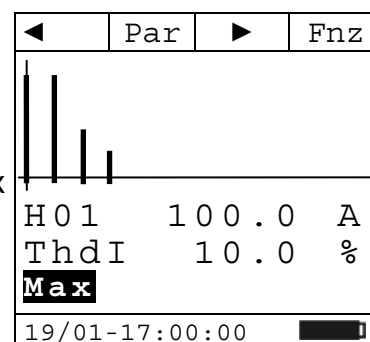

5.5.2.7. AC Energy

The screen shows an example of AC Energy measurement. The values of Active Energy, Reactive Energy, Inductive Energy and Capacitive Reactive Energy are shown.

Mod	Par	Sys	Fnz
	AC	50.0	Hz
	2.24		kWh
	0.84		kVar _{ih}
	0.00		kVar _{ch}
Log		1P	
19/01-17:00:00			

5.5.2.8. Hold

Short pressing key “H” activates the function Data HOLD. The display shows the message “” and the screen of the measurement in progress is “frozen”. This operating mode is deactivated when key “H” is pressed again or the switch is operated.

5.5.2.9. Backlight

Long pressing key “H” activates or deactivates the display backlight. This function automatically deactivates after approximately 10 seconds after being activated, in order not to discharge the batteries.

5.6. POSITION “W \approx ”: LOG, ON-LINE SCOPE, SNAPSHOT, MEMORY, DOWNLOAD



WARNING

The maximum DC or AC+DC input voltage is 1000V and the maximum measurable DC or AC+DC current is 1000A. Do not measure voltages and currents exceeding the limits given in this manual. Exceeding these limits could result in electrical shocks to the user and damage to the instrument. We recommend holding the clamp respecting the safety area created by the hand protection (see Fig. 3).

Turn the rotary switch to “W \approx ”. Insert the red cable into the input lead **V Ω**) and the black cable into the input lead **COM**, and connect the instrument as described in Fig. 12



WARNING

Insert the cable in the middle of the clamp jaws, in order to obtain accurate measures.
Use the marks as a reference (see Fig. 2).

5.6.1. Key F3 “Sys”

While measuring **DC**, **AC 1P** or **AC 3P** Power, press key **F3** (**Sys**) to open the drop-down menu shown on the screen to the side. At each subsequent pressure of key **F3**, the cursor will scroll through the available items, as follows:

- **Start Log**: it starts a recording of the electrical mains parameters;
- **On-line**: it starts a Bluetooth On-Line Scope;
- **Memory**: it shows the list of the saved data;
- **SnapShot**: it carries out an instant saving of the measured parameters;
- **Download**: it sets to the mode for downloading the data saved in the memory;
- **Esc**: it closes the drop-down menu.

Mod	Par	Sys	OK
	AC	Start Log	
		Online	
	21	Memory	
	7	SnapShot	
	22	Download	
		Esc	
19/01-17:00:00			

By pressing key **F4** (**OK**), the selected item is confirmed.

The electrical parameters recorded during a Recording, transmitted during an On-Line Scope or saved in a SnapShot, according to the mode set, are the following:

- **AC 1P:AC 1P**: P, Q, S, pF, dPf, V, I, THDV, THDI, hV01..hVxx (xx=25 for fundamental frequency 10..75Hz; xx=8 for fundamental frequency 75..400Hz);
- **AC 3P**: P, Q, S, pF, dPf, V, I, THDV, THDI, hV01..hVxx (xx=25 for fundamental frequency 10..75Hz; xx=8 for fundamental frequency 75..400Hz);
- **DC**: P, V, I.

5.6.1.1. “Start Log” recording

Upon confirming the “**Start Log**” item, the instrument sets to stand-by and waits for a recording to start. A recording shall be started when reaching the following minute as indicated by the instrument’s time.

The message “**Wait**” is displayed.

Mod	Par	Sys	Fnz
	AC	50.0	Hz
	21	47	kW
	7	68	kVARI
	22	90	kVA
Wait		1P	
19/01-17:00:35			



WARNING

When a recording is in progress, if the selector switch of the clamp is moved to any other position, the recording shall be interrupted. In the memory, you will find the values stored up to that moment.

While recording, the display shows the message “**Log**” and keys **F2 (Par)** and **F4 (Fnz)** are active, which give the possibility of displaying the parameters or enabling the functions seen in the previous paragraphs.

Mod	Par	Sys	Fnz
	AC	50.0	Hz
	21.47		kW
	7.68		kVARI
	22.90		kVA
Log		1P	
19/01-17:01:00			

While recording, press key **F3 (Sys)** to open the drop-down menu shown in the screen to the side. At each subsequent pressure of key **F3**, the cursor will scroll through the available items, as follows:

- **Stop Log**: it stops the recording in progress;
- **Info**: it shows some information about the recording in progress;
- **Esc**: it closes the drop-down menu.

By pressing key **F4 (OK)**, the selected item is confirmed.

Mod	Par	Sys	OK
	AC		Stop Log
	21.4		Info
	7.6		Esc
	22.90		kVARI
			kVA
Log			
19/01-17:01:00			

On the right, an example of the screen which is displayed when the item **Info** is selected. It shows:

- **Start**: starting date and time of recording;
- **Int. Period**: the integration period set (see par. 5.2.3);
- **N. Periods**: number of periods recorded;
- **Auton.**: memory autonomy expressed in days/hours.

Pressing key **F4 (Esc)** goes back to the parameter measuring screen.

Mod	Par	Sys	Fnz
			Esc
Start:			
19/01-17:01:00			
Int. Period: 1			
N. Periods: 00025			
Auton: 00d/02h			
19/01-17:01:25			

5.6.1.2. On-line

Upon confirming the “**On-line**” item, the instrument sets to Bluetooth transmission mode; the display shows the message “**Onl.**”.

Keys **F2 (Par)** and **F4 (Fnz)** are active, which give the possibility of displaying the parameters or enabling the functions seen in the previous paragraphs.

Mod	Par	Sys	Fnz
	AC	50.0	Hz
	21.47		kW
	7.68		kVARI
	22.90		kVA
Onl.		1P	
19/01-17:00:35			



WARNING

When an on-line transmission is in progress, if the selector switch of the clamp is moved to any other position, the transmission shall be interrupted.

During a Bluetooth transmission, press key **F3 (Sys)** to open the drop-down menu shown in the screen to the side. At each subsequent pressure of key **F3**, the cursor will scroll through the available items, as follows:

- **Stop**: it stops the transmission in progress;
- **Esc**: it closes the drop-down menu.
By pressing key **F4 (OK)**, the selected item is confirmed.

Mod	Par	Sys	OK
	AC	Stop	Hz
	21.4	Esc	W
	7.68	kV	ari
	22.90	kV	A
	Onl.		
19/01-17:01:00			

5.6.1.3. Memory

Upon confirming the “**Memory**” item, the instrument shows the screen here to the side.

The screen lists the recordings (**L**) with starting date and time and SnapShots (**S**) with saving date and time.

The residual memory autonomy is shown, expressed in days(d) / hours(h), according to the integration period set (see par. 5.2.3).

▼	Del	OK	Esc
S01:01/01-10:41:28			
S02:01/01-10:41:35			
L03:01/01-10:45:00			
S04:02/01-12:05:11			
L05:02/01-14:00:00			
Auton: 00d/02h			
19/01-17:00:35			

Each page lists 5 memory locations; by pressing key **F1 (▼)**, it is possible to scroll through the following pages.

Press key **F2 (Can)** to open the drop-down menu shown on the screen to the side. At each subsequent pressure of key **F2**, the cursor will scroll through the available items, as follows:

- **Del. Tot.**: it deletes all Recordings (L) and Snapshots (S) saved in the memory;
- **Del. Last**: it deletes the last information saved in the memory.

When pressing key **F3 (OK)** once, the display shows the message “**Delete?**”; pressing key **F3** again confirms the selected item.

By pressing key **F4 (Esc)** once, the selected item is not confirmed. Pressing key **F4** again goes back to the parameter measuring screen.

▼	Del	OK	Esc
S01:01/01-10:41:28	Del.Tot.		28
S02:01/01-10:41:35	Del.Last		35
L03:01/01-10:45:00			
S04:02/01-12:05:11			
L05:02/01-14:00:00			
Auton: 00d/02h			
	Delete?		
19/01-17:00:35			

5.6.1.4. SnapShot

Upon confirming the “**SnapShot**” item, the instrument instantly saves the measured parameters and shows the message “**Mem Ok**” on the display for 1 second, to confirm that saving has been carried out.

Mod	Par	Sys	Fnz
	AC	50.0	Hz
	21.47		kW
	7.68	kV	ari
	22.90	kV	A
	Mem Ok	1P	
19/01-17:00:35			

5.6.1.5. Download

Upon confirming the “**Download**” item, the instrument sets to the mode for downloading the data saved in the memory and shows the screen to the side.

Pressing key **F4 (Esc)** goes back to the parameter measuring screen.

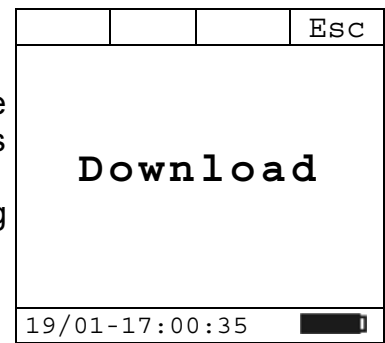

5.7. POSITION “Ω”): RESISTANCE AND CONTINUITY MEASUREMENT



WARNING

Before attempting any resistance measurement, remove power from the circuit under test and discharge all capacitors, if present.

By positioning the selector switch to “Ω”), the screen to the side will appear.

Mod		OK	Fnz
> 60.0 kΩ			
19/01-17:00:00			



Fig. 13: resistance measurement

Insert the red cable into the input lead VΩ) and the black cable into the input lead COM, and connect the instrument as described in Fig. 13.

Press key **F1 (Mod)** to open the drop-down menu shown on the screen to the side. At each subsequent pressure of key **F1**, the cursor will scroll through the available items, as follows:

- **Resistance**: resistance measurement;
- **Continuity**: continuity measurement;
- **Help**: it displays the connection between instrument and system;
- **Esc**: it closes the drop-down menu.

Select the desired mode and press key **F3 (OK)** to confirm.

Mod		OK	Fnz
Resistance)	kΩ
Continuity			
Help			
Esc			
19/01-17:00:00			

The screen shows an example of Resistance measurement.

Mod		OK	Fnz
50.0 kΩ			
19/01-17:00:00			█

The screen shows an example of Continuity measurement. If the measured resistance is lower than the limit resistance value set (see par. 5.2.5) shown below (Lim Res: 1Ω), the Buzzer sounds continuously.

Mod		OK	Fnz
0.3 Ω			
Res Lim:		1 Ω	
19/01-17:00:00			█

5.7.1. Key F4 “Fnz”

While measuring Resistance or Continuity, press key **F4 (Fnz)** to open the drop-down menu shown on the screen to the side. At each subsequent pressure of key **F4**, the cursor will scroll through the available items, as follows:

- **Max**: it constantly displays the maximum resistance value measured;
- **Min**: it constantly displays the minimum resistance value measured;
- **Rst**: it deletes all stored Max and Min values;
- **Esc**: it goes back to a normal measuring mode.

Mod		OK	Fnz
50.0			Max Min Rst Esc
19/01-17:00:00			█

By pressing key **F3 (OK)**, the selected item is confirmed. To the side, an example of measurement with active Max function. The display shows the active function.

Mod		OK	Fnz
Max			
50.0 kΩ			
19/01-17:00:00			█

5.7.1.1. Hold

Short pressing key “**H**” activates the function Data HOLD. The display shows the message “**H**” and the screen of the measurement in progress is “frozen”.

This operating mode is deactivated when key “**H**” is pressed again or the switch is operated.

5.7.1.2. Backlight

Long pressing key “**H**” activates or deactivates the display backlight. This function automatically deactivates after approximately 10 seconds after being activated, in order not to discharge the batteries.

5.8. POSITION “INRUSH A_∞”: INRUSH CURRENT MEASUREMENT



WARNING

- The maximum measurable DC or AC+DC current is 1000A. Do not measure currents exceeding the limits given in this manual. Exceeding these limits could result in electrical shocks to the user and damage to the instrument.
- We recommend holding the clamp respecting the safety area created by the hand protection (see Fig. 3).
- Currents <3A are zeroed.

By positioning the selector switch to “InRush A_∞”, the screen to the side will appear.
The display shows the current settings for recording inrush currents (see par. 5.2.4).

Mod	Zero	Run	Mem
50Hz			01/10
		10	A
Fix	15A	1/1	
19/01-17:00:00			

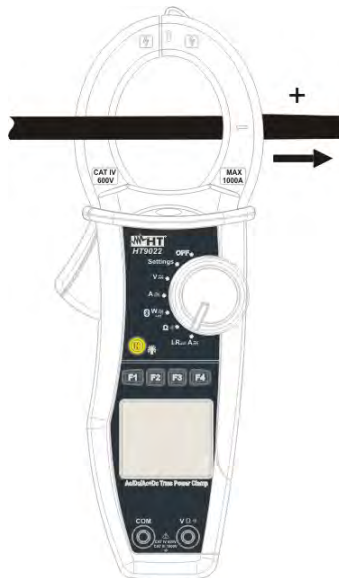

Fig. 14: inrush current measurement

Press key **F1 (Mod)** to open the drop-down menu shown on the screen to the side. At each subsequent pressure of key **F1**, the cursor will scroll through the available items, as follows:

- **50Hz**: 50Hz inrush current measurement;
 - **60Hz**: 60Hz inrush current measurement;
 - **400Hz**: 400Hz inrush current measurement;
 - **DC**: DC inrush current measurement;
 - **Help**: it displays the connection between instrument and system;
 - **Esc**: it closes the drop-down menu.
- Select the desired mode and press key **F4 (OK)** to confirm.

Mod	Zero	Run	OK
50Hz			01/10
60Hz			
400Hz			
DC			
Help		10	A
Esc	15A	1/1	
19/01-17:00:00			

5.8.1. Virtual key “Zero”

By pressing key **F2 (Zero)**, the average value of measured current is zeroed.



WARNING

Note: carry out current zeroing before clamping the conductor.

5.8.2. Key F3 “Run”



WARNING

For any frequency of 50Hz, 60Hz and DC, 32 samples are taken in each half-period for 100 half-periods, while for a frequency of 400Hz 8 samples are taken every half-period for 100 half-periods.

In Fix mode, the event is detected when the RMS value of the current exceeds the set current threshold value.

In Var mode, the event is detected when the difference between the RMS value of a half-period and that of the previous one exceeds the set current threshold value.

The maximum number of events which can be saved in a single campaign is 10 and the maximum number of storable recordings is 20.

Pressing key **F3 (Run)** starts an inrush current recording and the indication relevant to key F3 turns into **Stp**. On the right, a sample screen, which contains:

- the message “**Log**”, to indicate that recording is in progress;
- indication “**03/10**”, relevant to the last detected event;
- indication of date/time and current value reached by the last detected event.

By pressing key **F3 (Stp)** again, recording is stopped and the data are stored in the memory.

If 10 events are detected while recording, recording is automatically stopped.

Mod	Zero	Stp	Mem
50Hz			03/10
24/01-16:30:49			
		19	A
Fix	15A	1/1	
Log			
24/01-16:30:50			

5.8.3. Key F4 “Mem”

By pressing key **F4 (Mem)**, the screen to the side appears, which lists the Inrush Currents saved in the memory.

Each displayed page lists 5 memory locations and, by pressing key **F1 (▼)**, it is possible to scroll through each single location.

▼	Del	OK	Esc
I01:24/01-16:23:13			
I02:24/01-16:26:23			
I03:24/01-16:30:47			
I04:24/01-16:53:38			
I05:24/01-17:06:45			
25/01-17:05:00			

Press key **F2 (Can)** to open the drop-down menu shown on the screen to the side. At each subsequent pressure of key **F2**, the cursor will scroll through the available items, as follows:

- **Del. Tot.:** it deletes all InRush current data saved in the memory;
- **Del. Last:** it deletes the last information saved in the memory.

When pressing key **F3 (OK)** once, the display shows the message “**Delete?**”; pressing key **F3** again confirms the selected item

▼	Del	OK	Esc
I01:2	Del. Tot.	3	
I02:2	Del. Last	3	
I03:24/01-16:30:47			
I04:24/01-16:53:38			
I05:24/01-17:06:45			
25/01-17:05:00			

By pressing key **F4 (Esc)** once, the selected item is not confirmed. Pressing key F4 again takes you back to the Inrush Current measuring screen.

Pressing key **F3 (OK)** shows the trend of inrush current relevant to the selected memory location. It shows:

- starting date/time of the recorded event;
- maximum current value reached during the event;
- number of the event relevant to the measuring campaign;
- measuring modes set relevant to the measuring campaign;
- the number of the selected location.

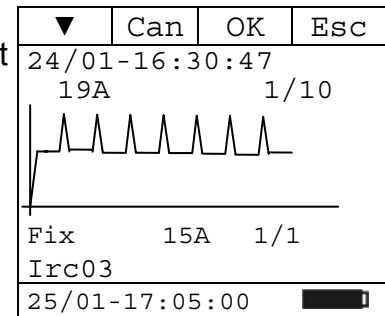

By pressing key **F1 (▼)**, it is possible to display the other events relevant to the selected campaign.

Pressing key **F4 (Esc)** goes back to the list of the Inrush Currents saved in the memory (see par. 5.8.3).

6. MAINTENANCE

6.1. GENERAL INFORMATION

1. The instrument you purchased is a precision instrument. While using and storing the instrument, carefully observe the recommendations listed in this manual in order to prevent possible damage or danger during use.
2. Do not use the instrument in environments with high humidity levels or high temperatures. Do not expose to direct sunlight.
3. Always switch off the instrument after use. In case the instrument is not to be used for a long time, remove the batteries to avoid liquid leaks that could damage the instrument's internal circuits.

6.2. BATTERY REPLACEMENT



WARNING

Only expert and trained technicians should perform this operation. Before carrying out this operation, make sure you have removed all cabled from the input leads or the cable being tested from inside the clamp jaw.

1. Turn the rotary switch to the OFF position.
2. Disconnect the cabled from the input leads and the cable being tested from the clamp jaw.
3. Loosen the battery cover fastening screw and remove the cover.
4. Remove the flat batteries from the battery compartment.
5. Insert two new batteries of the same type (1.5V LR 03 AAA). Pay attention to the correct polarity.
6. Position the battery cover back over the compartment and fasten it with the relevant screw.
7. Do not scatter old batteries into the environment. Use the relevant containers for disposal.

6.3. CLEANING THE INSTRUMENT

Use a soft and dry cloth to clean the instrument. Never use wet cloths, solvents, water, etc.

6.4. END OF LIFE



WARNING: the symbol on the instrument indicates that the appliance and its accessories must be collected separately and correctly disposed of.

7. TECHNICAL SPECIFICATIONS

7.1. TECHNICAL CHARACTERISTICS

Uncertainty is indicated as [% of reading + digit number]. It is referred to the following reference conditions: temperature 23°C ± 5°C with relative humidity < 80%.

DC voltage

Range	Resolution	Uncertainty	Protection against overcharge
0.5 ÷ 999.9V	0.1V	±(1.0%rdg+4dgt)	1000VDC/ACrms

Input impedance: 2.6MΩ

AC Voltage (AC+DC TRMS)

Range	Resolution	Uncertainty		Protection against overcharge
		43 ÷ 63Hz	10 ÷ 47Hz, 63 ÷ 400Hz	
0.5 ÷ 999.9V	0.1V	±(1.0%rdg+3dgt)	±(3.5%rdg+3dgt)	1000VDC/ACrms

Input impedance: 2.6MΩ; Max. Crest Factor: 1.41

AC/DC voltage: MAX / MIN / CREST

Function	Range	Resolution	Uncertainty	Response time
MAX,MIN,CREST	0.5 ÷ 999.9V	0.1V	±(3.5%rdg+5dgt)	1sec

Input impedance: 2.6MΩ; Max. Crest Factor: 1.41

DC current

Range	Resolution	Uncertainty	Protection against overcharge
0.5 ÷ 999.9A	0.1A	±(2.0%rdg+5dgt)	2000ADC/ACrms

AC current (AC+DC TRMS)

Range	Resolution	Uncertainty		Protection against overcharge
		43 ÷ 63Hz	10 ÷ 47Hz, 63 ÷ 400Hz	
0.5 ÷ 999.9A	0.1A	±(2.0%rdg+4dgt)	±(3.5%rdg+5dgt)	2000ADC/ACrms

Max. Crest Factor: 3

Corrente AC/DC:AC/DC current: MAX / MIN / CREST

Function	Range	Resolution	Uncertainty	Response time
MAX,MIN,CREST	0.5 ÷ 999.9A	0.1A	±(3.5%rdg+5dgt)	1sec

Max. Crest Factor: 3

Resistance and Continuity test

Range	Best resolution	Uncertainty	Protection against overcharge
0.0Ω ÷ 59.9kΩ	0.1Ω	±(1.0%rdg+5dgt)	1000VDC/ACrms x 60s

Frequency (with test leads/ with jaws)

Range	Resolution	Uncertainty	Protection against overcharge
10.0 ÷ 99.9Hz	0.1Hz	±(1.0%rdg+5dgt)	1000VDC/ACrms
100 ÷ 400Hz	1Hz		2000ADC/ACrms

Voltage range for frequency measure: 0.5 ÷ 1000V / Current range for frequency measure with jaws: 0.5 ÷ 1000A

DC power

Range [kW]	Resolution [kW]	Uncertainty
0.00 ÷ 99.99	0.01	±(3.0%rdg+3dgt)
100.0 ÷ 999.9	0.1	

Uncertainty defined for: Voltage > 10V, Current ≥ 2A

Active Power, Apparent power:

Range [kW], [kVA]	Resolution [kW], [kVA]	Uncertainty
0.00 ÷ 99.99	0.01	±(2.0%rdg+3dgt)
100.0 ÷ 999.9	0.1	

Uncertainty defined for: sine waveform 10..65Hz, Voltage > 10V, Current ≥ 2A, Pf ≥ 0.5

Range [kW], [kVA]	Resolution [kW], [kVA]	Uncertainty
0.00 ÷ 99.99	0.01	±(3.0%rdg+3dgt)
100.0 ÷ 999.9	0.1	

Uncertainty defined for: sine waveform > 65Hz, Voltage > 10V, Current ≥ 5A, Pf ≥ 0.5

Active Energy

Range [kWh]	Resolution [kWh]	Uncertainty
0.00 ÷ 99.99	0.01	±(2.0%rdg+3dgt)
100.0 ÷ 999.9	0.1	

Uncertainty defined for: sine wave 10..65Hz, Voltage > 10V, Current ≥ 2A, Pf ≥ 0.5

Range [kWh]	Resolution [kWh]	Uncertainty
0.00 ÷ 99.99	0.01	±(3.0%rdg+3dgt)
100.0 ÷ 999.9	0.1	

Uncertainty defined for: sine waveform > 65Hz, Voltage > 10V, Current ≥ 5A, Pf ≥ 0.5

Reactive Power

Range [kVAR]	Resolution [kVAR]	Uncertainty
0.00 ÷ 99.99	0.01	±(2.0%rdg+3dgt)
100.0 ÷ 999.9	0.1	

Uncertainty defined for: sine wave 10..65Hz, Voltage > 10V, Current ≥ 2A, 0.992 ≥ Pf ≥ 0.5

Range [kVAR]	Resolution [kVAR]	Uncertainty
0.00 ÷ 99.99	0.01	±(3.0%rdg+3dgt)
100.0 ÷ 999.9	0.1	

Uncertainty defined for: sine waveform > 65Hz, Voltage > 10V, Current ≥ 5A, 0.992 ≥ Pf ≥ 0.5

Reactive Energy

Range [kVARh]	Resolution [kVARh]	Uncertainty
0.00 ÷ 99.99	0.01	±(2.0%rdg+3dgt)
100.0 ÷ 999.9	0.1	

Uncertainty defined for: sine wave 10..65Hz, Voltage > 10V, Current ≥ 2A, 0.992 ≥ Pf ≥ 0.5

Range [kVARh]	Resolution [kVARh]	Uncertainty
0.00 ÷ 99.99	0.01	±(3.0%rdg+3dgt)
100.0 ÷ 999.9	0.1	

Uncertainty defined for: sine waveform > 65Hz, Voltage > 10V, Current ≥ 5A, 0.992 ≥ Pf ≥ 0.5

Power factor

Range	Resolution	Uncertainty
0.20 ÷ 1.00	0.01	±3°

Uncertainty defined for: sine waveform 10..65Hz, Voltage > 10V, Current ≥ 2A

Uncertainty defined for: sine waveform > 65Hz, Voltage > 10V, Current ≥ 5A

Voltage and Current harmonics

Harmonic order	Frequency [Hz]	Resolution [V], [A]	Uncertainty
1 ÷ 25	10 ÷ 75	0.1	±(5.0%rdg+5dgt)
1 ÷ 8	75 ÷ 400		

Phase sequence and 1-lead phase coincidence

Range	Input impedance
100 ÷ 1000V	1.3MΩ

Frequency range: 40..70Hz.

(*) Measurement carried out under the following standard conditions: instrument firmly held in the hand, standard shoes, standard floor, etc.

7.1.1. Safety standards

Compliant with Standards:	IEC / EN61010-1, IEC / EN61010-2 – 032
Technical documentation:	IEC/EN61187
Safety of measuring accessories:	IEC/EN61010-31
Insulation:	Class 2, double insulation
Pollution level:	2
Max height:	2000m, indoor use
Overvoltage category:	CAT IV 600V / CAT III 1000V to earth, max 1000V between inputs

7.1.2. General characteristics

Characteristics of radio module

Radio:	Bluetooth V2.0
Frequency:	2.4 GHz (2400-2483.5MHz)
Power:	Class 2
Data rate:	57600 baud

Memory

Internal memory:	2Mbytes
------------------	---------

Recordings

N°. max Log + Snapshot stores:	99
N°. max InRush stores:	20 (each with max 10 events)

Mechanical characteristics

Size:	252 (L) x 88 (W) x 44 (H) mm; 9.92 x 3.46 x 1.73 in
Weight (batteries included):	approx 420g; 14.8 ounces
Jaw opening / Max cable size:	45mm; 1.77 in

Power supply

Battery type:	2 batteries x 1.5V LR 03 AAA
Battery life:	approx. 53 hours of use in “W _≡ ” position
Auto power OFF:	5 min. with enabled function The display shows the following symbol “  ”

Display

Characteristics:	graphic display 128x128 pixels
Sampling rate:	128 samples per period (base sampling)
Updating frequency:	1/s

7.2. ENVIRONMENT

7.2.1. Environmental conditions for use

Reference calibration temperature:	23° ± 5 °C
Operating temperature:	0 ÷ 40 °C
Allowable relative humidity:	< 80%
Storage temperature:	-10 ÷ 60 °C
Storage humidity:	< 70%

This instrument satisfies the requirements of Low Voltage Directive 2006/95/EEC (LVD) and of EMC Directive 2004/108/EEC

7.3. ACCESSORIES PROVIDED

- Instrument
- Pair of test leads
- Pair of alligator clips
- ISO9000 calibration certificate
- User manual
- Bag
- Batteries

8. SERVICE

8.1. WARRANTY CONDITIONS

This instrument is warranted against any material or manufacturing defect, in compliance with the general sales conditions. During the warranty period, defective parts may be replaced. However, the manufacturer reserves the right to repair or replace the product.

The warranty shall not apply in the following cases:

- Repair and/or replacement of accessories and batteries (not covered by warranty).
- Repairs that may become necessary as a consequence of an incorrect use of the instrument or due to its use together with non-compatible appliances.
- Repairs that may become necessary as a consequence of improper packaging.
- Repairs which may become necessary as a consequence of interventions performed by unauthorized personnel.
- Modifications to the instrument performed without the manufacturer's explicit authorization.
- Use not provided for in the instrument's specifications or in the instruction manual.

The content of this manual cannot be reproduced in any form without the manufacturer's authorization.

Our products are patented and our trademarks are registered. The manufacturer reserves the right to make changes in the specifications and prices if this is due to improvements in technology.

8.2. SERVICE

If the instrument does not operate properly, before contacting the After-sales Service, please check the conditions of batteries and cables and replace them, if necessary. Should the instrument still operate improperly, check that the product is operated according to the instructions given in this manual.

Should the instrument be returned to the After-sales Service or to a Dealer, transport will be at the Customer's charge. However, shipment will be agreed in advance.

A report will always be enclosed to a shipment, stating the reasons for the product's return. Only use original packaging for shipment; any damage due to the use of non-original packaging material will be charged to the Customer.

9. APPENDIX – THEORETICAL OUTLINE

9.1. CALCULATION OF POWERS IN “AC 1P” MODE

The instrument measures the values of Rms Voltage and Rms Current and calculates the average Power values for each period. The formulas for power calculation are:

$$P = \frac{1}{N} \times \sum_{i=1}^N v_i \times i_i$$

$$S = \sqrt{\frac{1}{N} \times \sum_{i=1}^N v_i^2} \times \sqrt{\frac{1}{N} \times \sum_{i=1}^N i_i^2}$$

$$Q = \sqrt{S^2 - P^2}$$

$$Pf = \frac{P}{S}$$

where:

N = number of samples in the period

9.2. CALCULATION OF POWERS IN “AC 3P” MODE

The instrument measures the values of Rms Voltage and Rms Current and calculates the average Power values for each period. The formulas for power calculation are:

$$Q = \sqrt{3} \times \frac{1}{N} \times \sum_{i=1}^N v_i \times i_i$$

$$S = \sqrt{3} \times \sqrt{\frac{1}{N} \times \sum_{i=1}^N v_i^2} \times \sqrt{\frac{1}{N} \times \sum_{i=1}^N i_i^2}$$

$$P = \sqrt{S^2 - Q^2}$$

$$Pf = \frac{P}{S}$$

where:

N = number of samples in the period

9.3. CALCULATION OF POWERS IN “DC” MODE

The instrument measures the values of Avg Voltage and Avg Current and calculates the average Power value for each period. The formula for power calculation is:

$$P = \left(\frac{1}{N} \times \sum_{i=1}^N v_i \right) \times \left(\frac{1}{N} \times \sum_{i=1}^N i_i \right)$$

9.4. VOLTAGE AND CURRENT HARMONICS

Any periodic non-sinusoidal wave may be represented by a sum of sinusoidal waves, each with a frequency which is a whole multiple of the fundamental, according to the relationship:

$$v(t) = V_0 + \sum_{k=1}^{\infty} V_k \sin(\omega_k t + \phi_k) \quad (1)$$

where:

V_0 = Average value of $v(t)$

V_1 = Amplitude of the fundamental of $v(t)$

V_k = Amplitude of the k -nth harmonic of $v(t)$

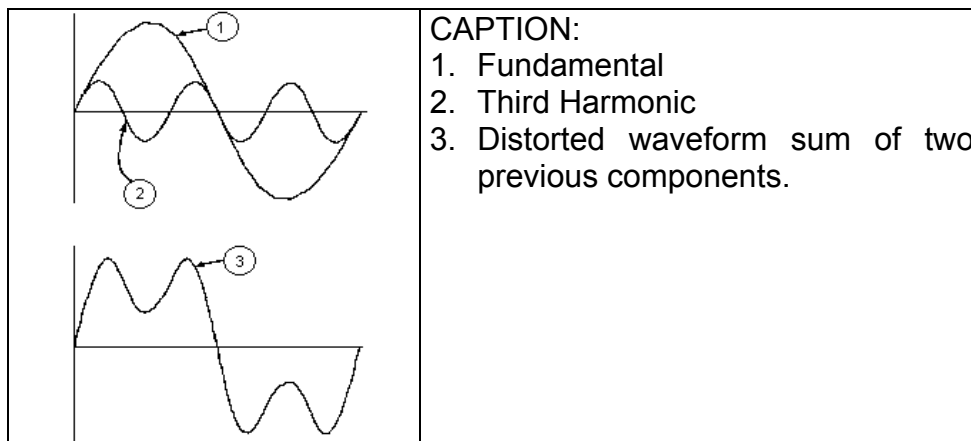

Effect of the sum of 2 multiple frequencies.

For network voltage, the fundamental has a frequency of 50 Hz, the second harmonic has a frequency of 100 Hz, the third harmonic has a frequency of 150 Hz and so on. Harmonic distortion is a continuous problem and must not be confused with short-duration phenomena such as peaks, drops or fluctuations.

It can be seen from (1) that each signal consists of the summation of infinite harmonics. However, an order number exists beyond which the value of the harmonics may be considered as negligible. Standard EN 50160 suggests cutting the summation in the expression (1) at the 40th harmonic.

A fundamental index to detect the presence of harmonics is the THD defined as:

$$THD_v = \frac{\sqrt{\sum_{h=2}^{40} V_h^2}}{V_1}$$

This index takes into consideration the presence of all harmonics, and the more distorted is the waveform, the higher is the index.

9.5. LIMIT VALUES FOR HARMONICS

Standard EN-50160 prescribes the limits for the Voltage Harmonics the Energy Provider may introduce into the network. In normal operating conditions, at any time in a week, 95% of the efficient values of each harmonic voltage, averaged to 10 minutes, must be lower than or equal to the values indicated in the following Table.

The total harmonic distortion (THD%) of supply voltage (including all harmonics up to the 40th order) must be lower than or equal to 8%.

Odd Harmonics				Even Harmonics	
Not multiple of 3		Multiple of 3		Order h	Relative Voltage %Max
Order h	Relative Voltage %Max	Order h	Relative Voltage %Max		
5	6	3	5	2	2
7	5	9	1,5	4	1
11	3,5	15	0,5	6..24	0,5
13	3	21	0,5		
17	2				
19	1,5				
23	1,5				
25	1,5				

These limits, which theoretically apply only to Electric Power Suppliers, anyway provide a series of reference values within which also the harmonics put into network by users should be kept.

9.6. CAUSES OF THE PRESENCE OF HARMONICS

Any appliance altering the sinusoidal wave or simply using a part of such wave causes distortions to the sinusoid, and hence harmonics.

All current signals are therefore somewhat virtually distorted. The most common distortion is the harmonic distortion caused by non-linear loads such as household appliances, personal computers or motor speed adjusters. Harmonic distortion generates significant currents at frequencies which are whole multiples of network voltage. Harmonic currents have a remarkable effect on neutral conductors of electrical systems.

In most countries, the network voltage used is three-phase 50/60Hz, supplied by a transformer with triangle-connected primary circuit and star-connected secondary circuit. The secondary circuit generally generates 230V AC between phase and neutral and 400V AC between phase and phase. Balancing loads for each phase has always been a problem electrical system designers.

Until approximately ten years ago, in a well balanced system, the vector sum of the currents in the neutral was zero or anyway quite low (given the difficulty of obtaining a perfect balance). Connected devices were incandescent lights, small motors and other devices that presented linear loads. The result was an essentially sinusoidal current in each phase and a low current on the neutral at a frequency of 50/60Hz.

“Modern” devices such as TV sets, fluorescent lights, video machines and microwave ovens normally draw current for only a fraction of each cycle, thus causing non-linear loads and, consequently, non-linear currents. All this generates odd harmonics of the 50/60Hz line frequency. For this reason, nowadays the current in the transformers of the distribution boxes contains not only a 50Hz (or 60Hz) component, but also a 150Hz (or 180Hz) component, a 250Hz (or 300Hz) component and other significant harmonic components up to 750Hz (or 900Hz) and above.

The vector sum of the currents in a well balanced system that feeds non-linear loads may still be quite low. However, the sum does not eliminate all harmonic currents. The odd multiples of the third harmonic (called “TRIPLENS”) are added together in the neutral conductor and can cause overheating even with balanced loads.

9.7. CONSEQUENCE OF THE PRESENCE OF HARMONICS

Generally, harmonics of even, 2nd, 4th etc. order do not create problems.

Designers must consider the following points when designing a power distribution system containing harmonic currents:

Installation parts	Effects attributed to Harmonics
Fuses	Non-uniform heating of internal fuse element and consequent overheating which can also lead to an explosion of the fuse casing.
Cables	Increase in “body” effect; this means that, for cables with many wires, the internal wires have higher impedance than the external wires. As a consequence, current, which normally distributes along the external surface of the wire, produces: <ul style="list-style-type: none"> – over-heating of the conductor; – a premature degrading of the cable’s insulation; – an increase in line voltage drop.
Neutral conductor	Triple harmonics, odd multiple of three, sum on neutral (instead of nullifying themselves), thus generating a potentially dangerous overheating of the conductor.
Transformers	Increase in copper loss due to a higher TRMS value of the current that circulates on internal circuits, and also due to the “body” effect on protected wires. Increase of iron loss due to hysteresis cycle distortion and due to the generation of leakage currents on the magnetic core. Heating of insulation material due to a possible DC component that can generate saturation of the magnetic core column.
Motors	Increase of loss due to overheating of internal circuits and possible damage of insulation material. The 5 th and 11 th harmonic components generate some abnormal electromagnetic coupling that can increase motor speed.
Re-phasing capacitors	Increase in “parallel resonance” present inside a circuit, due to inductive loads and re-phasing capacitors, when at least one of the harmonics has the same frequency as the resonance phenomenon. Effects of this event can be very dangerous, with explosion of used re-phasing capacitors.
RCD devices	Possible saturation of current sensing toroidal transducers resulting in malfunction, both in terms of untimely intervention and increase of the intervention threshold.
Energy disk counters	Increased rotation speed of a disk resulting in measurement errors (especially in case of low power factor loads).
Power controls switch	Reduction of electric duration of contact surfaces.
UPS	Reduced power generation from UPS.
Electronics devices	Internal damage of electronic components not protected by suitable devices.