



User's manual FLIR Kx series

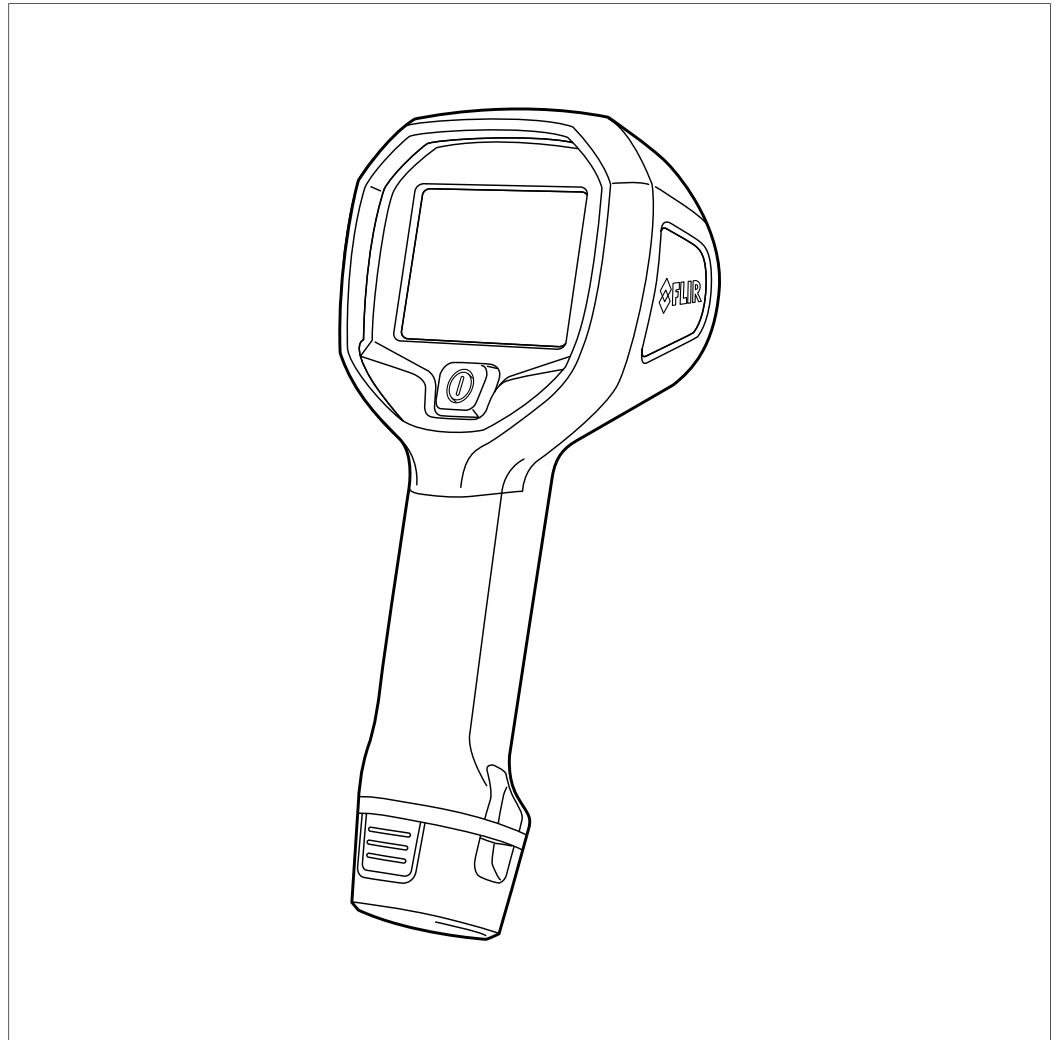

Table of contents

1	Legal disclaimer	1
1.1	Legal disclaimer	1
1.2	Usage statistics	1
1.3	Changes to registry	1
1.4	U.S. Government Regulations.....	1
1.5	Copyright	1
1.6	Quality assurance	1
1.7	Patents	1
1.8	EULA Terms	1
2	Safety information	2
3	Notice to user	6
3.1	User-to-user forums	6
3.2	Disposal of electronic waste	6
3.3	Training	6
3.4	Documentation updates	6
3.5	Important note about this manual.....	6
3.6	Note about authoritative versions.....	7
4	Customer help	8
4.1	General	8
4.2	Submitting a question	8
4.3	Downloads	9
5	Important information about FLIR Kx series service	10
6	Introduction	11
7	Quick start guide	12
8	Camera parts	13
8.1	View from the front	13
8.1.1	Figure.....	13
8.1.2	Explanation.....	13
8.2	View from the rear	14
8.2.1	Figure.....	14
8.2.2	Explanation.....	14
8.3	Lanyard strap.....	15
9	Screen elements	16
9.1	Figure	16
9.2	Explanation	16
10	Operation	17
10.1	Charging the battery	17
10.1.1	Charging the battery using the FLIR power supply	17
10.1.2	Charging the battery using the FLIR stand-alone battery charger.	17
10.1.3	Charging the battery using a USB cable	18
10.2	Turning on and turning off the camera.....	18
10.3	Accessing the connector bay	18
10.3.1	Procedure	18
10.4	Changing temperature unit.....	19
10.4.1	General.....	19
10.4.2	Procedure	19
10.5	Changing settings (in FLIR Tools)	20
10.5.1	General.....	20

Table of contents

	10.5.2 The <i>General settings</i> tab.....	20
	10.5.3 The <i>User interface</i> tab.....	21
	10.5.4 Camera modes.....	21
10.6	Updating the camera.....	26
	10.6.1 General.....	26
11	Technical data.....	27
11.1	Online field-of-view calculator.....	27
11.2	Note about technical data.....	27
11.3	Note about authoritative versions.....	27
11.4	FLIR K2.....	28
12	Mechanical drawings.....	32
13	CE Declaration of conformity.....	37
14	Cleaning the camera.....	39
14.1	Camera housing, cables, and other items.....	39
	14.1.1 Liquids.....	39
	14.1.2 Equipment.....	39
	14.1.3 Procedure.....	39
14.2	Infrared lens.....	39
	14.2.1 Liquids.....	39
	14.2.2 Equipment.....	39
	14.2.3 Procedure.....	39
15	About FLIR Systems.....	40
15.1	More than just an infrared camera.....	41
15.2	Sharing our knowledge.....	42
15.3	Supporting our customers.....	42

1.1 Legal disclaimer

All products manufactured by FLIR Systems are warranted against defective materials and workmanship for a period of one (1) year from the delivery date of the original purchase, provided such products have been under normal storage, use and service, and in accordance with FLIR Systems instruction.

Uncooled handheld infrared cameras manufactured by FLIR Systems are warranted against defective materials and workmanship for a period of two (2) years from the delivery date of the original purchase, provided such products have been under normal storage, use and service, and in accordance with FLIR Systems instruction, and provided that the camera has been registered within 60 days of original purchase.

Detectors for uncooled handheld infrared cameras manufactured by FLIR Systems are warranted against defective materials and workmanship for a period of ten (10) years from the delivery date of the original purchase, provided such products have been under normal storage, use and service, and in accordance with FLIR Systems instruction, and provided that the camera has been registered within 60 days of original purchase.

Products which are not manufactured by FLIR Systems but included in systems delivered by FLIR Systems to the original purchaser, carry the warranty, if any, of the particular supplier only. FLIR Systems has no responsibility whatsoever for such products.

The warranty extends only to the original purchaser and is not transferable. It is not applicable to any product which has been subjected to misuse, neglect, accident or abnormal conditions of operation. Expendable parts are excluded from the warranty.

In the case of a defect in a product covered by this warranty the product must not be further used in order to prevent additional damage. The purchaser shall promptly report any defect to FLIR Systems or this warranty will not apply.

FLIR Systems will, at its option, repair or replace any such defective product free of charge if, upon inspection, it proves to be defective in material or workmanship and provided that it is returned to FLIR Systems within the said one-year period.

FLIR Systems has no other obligation or liability for defects than those set forth above.

No other warranty is expressed or implied. FLIR Systems specifically disclaims the implied warranties of merchantability and fitness for a particular purpose.

FLIR Systems shall not be liable for any direct, indirect, special, incidental or consequential loss or damage, whether based on contract, tort or any other legal theory.

This warranty shall be governed by Swedish law.

Any dispute, controversy or claim arising out of or in connection with this warranty, shall be finally settled by arbitration in accordance with the Rules of the Arbitration Institute of the Stockholm Chamber of Commerce. The place of arbitration shall be Stockholm. The language to be used in the arbitral proceedings shall be English.

1.2 Usage statistics

FLIR Systems reserves the right to gather anonymous usage statistics to help maintain and improve the quality of our software and services.

1.3 Changes to registry

The registry entry HKEY_LOCAL_MACHINE\SYSTEM\CurrentControlSet\Control\Lsa\LmCompatibilityLevel will be automatically changed to level 2 if the FLIR Camera Monitor service detects a FLIR camera connected to the computer with a USB cable. The modification will only be executed if the camera device implements a remote network service that supports network logons.

1.4 U.S. Government Regulations

This product may be subject to U.S. Export Regulations. Please send any inquiries to exportquestions@flir.com.

1.5 Copyright

© 2016, FLIR Systems, Inc. All rights reserved worldwide. No parts of the software including source code may be reproduced, transmitted, transcribed or translated into any language or computer language in any form or by any means, electronic, magnetic, optical, manual or otherwise, without the prior written permission of FLIR Systems.

The documentation must not, in whole or part, be copied, photocopied, reproduced, translated or transmitted to any electronic medium or machine readable form without prior consent, in writing, from FLIR Systems.

Names and marks appearing on the products herein are either registered trademarks or trademarks of FLIR Systems and/or its subsidiaries. All other trademarks, trade names or company names referenced herein are used for identification only and are the property of their respective owners.

1.6 Quality assurance

The Quality Management System under which these products are developed and manufactured has been certified in accordance with the ISO 9001 standard.

FLIR Systems is committed to a policy of continuous development; therefore we reserve the right to make changes and improvements on any of the products without prior notice.

1.7 Patents

One or several of the following patents and/or design patents may apply to the products and/or features. Additional pending patents and/or pending design patents may also apply.

000279476-0001; 000439161; 000499579-0001; 000653423; 000726344; 000859020; 001106306-0001; 001707738; 001707746; 001707787; 001776519; 001954074; 002021543; 002058180; 002249953; 002531178; 0600574-8; 1144833; 1182246; 1182620; 1285345; 1299699; 1325808; 1336775; 1391114; 1402918; 1404291; 1411581; 1415075; 1421497; 1458284; 1678485; 1732314; 2106017; 2107799; 2381417; 3006596; 3006597; 466540; 483782; 484155; 4888913; 5177595; 60122153.2; 602004011681.5-08; 6707044; 68657; 7034300; 7110035; 7154093; 7157705; 7237946; 7312822; 7332716; 7336823; 7544944; 7667198; 7809258 B2; 7826736; 8,153,971; 8,823,803; 8,853,631; 8018649 B2; 8212210 B2; 8289372; 8354639 B2; 8384783; 8520970; 8565547; 8595689; 8599262; 8654239; 8680468; 8803093; D540838; D549758; D579475; D584755; D599,392; D615,113; D664,580; D664,581; D665,004; D665,440; D677298; D710,424 S; D718801; D16702302-9; D16903617-9; D17002221-6; D17002891-5; D17002892-3; D17005799-0; DM/057692; DM/061609; EP 2115696 B1; EP2315433; SE 0700240-5; US 8340414 B2; ZL 20130267619.5; ZL01823221.3; ZL01823226.4; ZL02331553.9; ZL02331554.7; ZL200480034894.0; ZL200530120994.2; ZL200610088759.5; ZL200630130114.4; ZL200730151141.4; ZL200730339504.7; ZL200820105768.8; ZL200830128581.2; ZL200880105236.4; ZL200880105769.2; ZL200930190061.9; ZL201030176127.1; ZL201030176130.3; ZL201030176157.2; ZL201030595931.3; ZL201130442354.9; ZL201230471744.3; ZL201230620731.8.

1.8 EULA Terms

- You have acquired a device ("INFRARED CAMERA") that includes software licensed by FLIR Systems AB from Microsoft Licensing, GP or its affiliates ("MS"). Those installed software products of MS origin, as well as associated media, printed materials, and "online" or electronic documentation ("SOFTWARE") are protected by international intellectual property laws and treaties. The SOFTWARE is licensed, not sold. All rights reserved.
- IF YOU DO NOT AGREE TO THIS END USER LICENSE AGREEMENT ("EULA"), DO NOT USE THE DEVICE OR COPY THE SOFTWARE. INSTEAD, PROMPTLY CONTACT FLIR Systems AB FOR INSTRUCTIONS ON RETURN OF THE UNUSED DEVICE(S) FOR A REFUND. **ANY USE OF THE SOFTWARE, INCLUDING BUT NOT LIMITED TO USE ON THE DEVICE, WILL CONSTITUTE YOUR AGREEMENT TO THIS EULA (OR RATIFICATION OF ANY PREVIOUS CONSENT).**
- **GRANT OF SOFTWARE LICENSE.** This EULA grants you the following license:
 - You may use the SOFTWARE only on the DEVICE.
 - **NOT FAULT TOLERANT.** THE SOFTWARE IS NOT FAULT TOLERANT. FLIR Systems AB HAS INDEPENDENTLY DETERMINED HOW TO USE THE SOFTWARE IN THE DEVICE, AND MS HAS RELIED UPON FLIR Systems AB TO CONDUCT SUFFICIENT TESTING TO DETERMINE THAT THE SOFTWARE IS SUITABLE FOR SUCH USE.
 - **NO WARRANTIES FOR THE SOFTWARE.** THE SOFTWARE IS provided "AS IS" and with all faults. THE ENTIRE RISK AS TO SATISFACTORY QUALITY, PERFORMANCE, ACCURACY, AND EFFORT (INCLUDING LACK OF NEGLIGENCE) IS WITH YOU. ALSO, THERE IS NO WARRANTY AGAINST INTERFERENCE WITH YOUR ENJOYMENT OF THE SOFTWARE OR AGAINST INFRINGEMENT. **IF YOU HAVE RECEIVED ANY WARRANTIES REGARDING THE DEVICE OR THE SOFTWARE, THOSE WARRANTIES DO NOT ORIGINATE FROM, AND ARE NOT BINDING ON, MS.**
 - No Liability for Certain Damages. **EXCEPT AS PROHIBITED BY LAW, MS SHALL HAVE NO LIABILITY FOR ANY INDIRECT, SPECIAL, CONSEQUENTIAL OR INCIDENTAL DAMAGES ARISING FROM OR IN CONNECTION WITH THE USE OR PERFORMANCE OF THE SOFTWARE. THIS LIMITATION SHALL APPLY EVEN IF ANY REMEDY FAILS OF ITS ESSENTIAL PURPOSE. IN NO EVENT SHALL MS BE LIABLE FOR ANY AMOUNT IN EXCESS OF U.S. TWO HUNDRED FIFTY DOLLARS (U.S.\$250.00).**
 - **Limitations on Reverse Engineering, Decompilation, and Disassembly.** You may not reverse engineer, decompile, or disassemble the SOFTWARE, except and only to the extent that such activity is expressly permitted by applicable law notwithstanding this limitation.
 - **SOFTWARE TRANSFER ALLOWED BUT WITH RESTRICTIONS.** You may permanently transfer rights under this EULA only as part of a permanent sale or transfer of the Device, and only if the recipient agrees to this EULA. If the SOFTWARE is an upgrade, any transfer must also include all prior versions of the SOFTWARE.
 - **EXPORT RESTRICTIONS.** You acknowledge that SOFTWARE is subject to U.S. export jurisdiction. You agree to comply with all applicable international and national laws that apply to the SOFTWARE, including the U.S. Export Administration Regulations, as well as end-user, end-use and destination restrictions issued by U.S. and other governments. For additional information see <http://www.micro-soft.com/exporting/>.

Safety information

 **WARNING**

Applicability: Cameras with one or more batteries.

Do not disassemble or do a modification to the battery. The battery contains safety and protection devices which, if damage occurs, can cause the battery to become hot, or cause an explosion or an ignition.

 **WARNING**

Applicability: Cameras with one or more batteries.

If there is a leak from the battery and you get the fluid in your eyes, do not rub your eyes. Flush well with water and immediately get medical care. The battery fluid can cause injury to your eyes if you do not do this.

 **WARNING**

Applicability: Cameras with one or more batteries.

Do not continue to charge the battery if it does not become charged in the specified charging time. If you continue to charge the battery, it can become hot and cause an explosion or ignition. Injury to persons can occur.

 **WARNING**

Applicability: Cameras with one or more batteries.

Only use the correct equipment to remove the electrical power from the battery. If you do not use the correct equipment, you can decrease the performance or the life cycle of the battery. If you do not use the correct equipment, an incorrect flow of current to the battery can occur. This can cause the battery to become hot, or cause an explosion. Injury to persons can occur.

 **WARNING**

Make sure that you read all applicable MSDS (Material Safety Data Sheets) and warning labels on containers before you use a liquid. The liquids can be dangerous. Injury to persons can occur.

 **CAUTION**

Do not point the infrared camera (with or without the lens cover) at strong energy sources, for example, devices that cause laser radiation, or the sun. This can have an unwanted effect on the accuracy of the camera. It can also cause damage to the detector in the camera.

 **CAUTION**

Applicability: Cameras with one or more batteries.

Do not attach the batteries directly to a car's cigarette lighter socket, unless FLIR Systems supplies a specific adapter to connect the batteries to a cigarette lighter socket. Damage to the batteries can occur.

 **CAUTION**

Applicability: Cameras with one or more batteries.

Do not connect the positive terminal and the negative terminal of the battery to each other with a metal object (such as wire). Damage to the batteries can occur.

 **CAUTION**

Applicability: Cameras with one or more batteries.

Do not get water or salt water on the battery, or permit the battery to become wet. Damage to the batteries can occur.

Safety information

 **CAUTION**

Applicability: Cameras with one or more batteries.

Do not make holes in the battery with objects. Damage to the battery can occur.

 **CAUTION**

Applicability: Cameras with one or more batteries.

Do not hit the battery with a hammer. Damage to the battery can occur.

 **CAUTION**

Applicability: Cameras with one or more batteries.

Do not put your foot on the battery, hit it or cause shocks to it. Damage to the battery can occur.

 **CAUTION**

Applicability: Cameras with one or more batteries.

Do not put the batteries in or near a fire, or into direct sunlight. When the battery becomes hot, the built-in safety equipment becomes energized and can stop the battery charging procedure. If the battery becomes hot, damage can occur to the safety equipment and this can cause more heat, damage or ignition of the battery.

 **CAUTION**

Applicability: Cameras with one or more batteries.

Do not put the battery on a fire or increase the temperature of the battery with heat. Damage to the battery and injury to persons can occur.

 **CAUTION**

Applicability: Cameras with one or more batteries.

Do not put the battery on or near fires, stoves, or other high-temperature locations. Damage to the battery and injury to persons can occur.

 **CAUTION**

Applicability: Cameras with one or more batteries.

Do not solder directly onto the battery. Damage to the battery can occur.

 **CAUTION**

Applicability: Cameras with one or more batteries.

Do not use the battery if, when you use, charge, or put the battery in storage, there is an unusual smell from the battery, the battery feels hot, changes color, changes shape, or is in an unusual condition. Speak with your sales office if one or more of these problems occurs. Damage to the battery and injury to persons can occur.

 **CAUTION**

Applicability: Cameras with one or more batteries.

Only use a specified battery charger when you charge the battery. Damage to the battery can occur if you do not do this.

Safety information

 **CAUTION**

Applicability: Cameras with one or more batteries.

Only use a specified battery for the camera. Damage to the camera and the battery can occur if you do not do this.

 **CAUTION**

Applicability: Cameras with one or more batteries.

The temperature range through which you can charge the battery is $\pm 0^{\circ}\text{C}$ to $+45^{\circ}\text{C}$ ($+32^{\circ}\text{F}$ to $+113^{\circ}\text{F}$), unless other information is specified in the user documentation or technical data. If you charge the battery at temperatures out of this range, it can cause the battery to become hot or to break. It can also decrease the performance or the life cycle of the battery.

 **CAUTION**

Applicability: Cameras with one or more batteries.

The temperature range through which you can remove the electrical power from the battery is -15°C to $+50^{\circ}\text{C}$ ($+5^{\circ}\text{F}$ to $+122^{\circ}\text{F}$), unless other information is specified in the user documentation or technical data. If you operate the battery out of this temperature range, it can decrease the performance or the life cycle of the battery.

 **CAUTION**

Applicability: Cameras with one or more batteries.

When the battery is worn, apply insulation to the terminals with adhesive tape or equivalent materials before you discard it. Damage to the battery and injury to persons can occur if you do not do this.

 **CAUTION**

Applicability: Cameras with one or more batteries.

Remove any water or moisture on the battery before you install it. Damage to the battery can occur if you do not do this.

 **CAUTION**

Do not apply solvents or equivalent liquids to the camera, the cables, or other items. Damage to the battery and injury to persons can occur.

 **CAUTION**

Be careful when you clean the infrared lens. The lens has an anti-reflective coating which is easily damaged. Damage to the infrared lens can occur.

 **CAUTION**

Do not use too much force to clean the infrared lens. This can cause damage to the anti-reflective coating.

Note The encapsulation rating is only applicable when all the openings on the camera are sealed with their correct covers, hatches, or caps. This includes the compartments for data storage, batteries, and connectors.

 **CAUTION**

Do not change the standard fire-fighting procedures when you use a FLIR K series camera. The FLIR K series camera is not a replacement technology.

**CAUTION**

Do not use the FLIR K series camera without the correct training. If the persons that operate the camera do not have the correct training, an incorrect analysis of the infrared images can occur. Thus, incorrect decisions during the firefighting can be made.

The training must include:

- How a thermal camera operates and its limits
- How to interpret an image
- How to work safely with the camera.

3.1 User-to-user forums

Exchange ideas, problems, and infrared solutions with fellow thermographers around the world in our user-to-user forums. To go to the forums, visit:

<http://forum.infraredtraining.com/>

3.2 Disposal of electronic waste



As with most electronic products, this equipment must be disposed of in an environmentally friendly way, and in accordance with existing regulations for electronic waste.

Please contact your FLIR Systems representative for more details.

3.3 Training

To read about infrared training, visit:

- <http://www.infraredtraining.com>
- <http://www.irtraining.com>
- <http://www.irtraining.eu>

3.4 Documentation updates

Our manuals are updated several times per year, and we also issue product-critical notifications of changes on a regular basis.

To access the latest manuals, translations of manuals, and notifications, go to the Download tab at:

<http://support.flir.com>

It only takes a few minutes to register online. In the download area you will also find the latest releases of manuals for our other products, as well as manuals for our historical and obsolete products.

3.5 Important note about this manual

FLIR Systems issues generic manuals that cover several cameras within a model line.

This means that this manual may contain descriptions and explanations that do not apply to your particular camera model.

3.6 Note about authoritative versions

The authoritative version of this publication is English. In the event of divergences due to translation errors, the English text has precedence.

Any late changes are first implemented in English.

FLIR Customer Support Center

Home | Answers | Ask a Question | Product Registration | Downloads | My Stuff | Service

FLIR Customer support

Get the most out of your FLIR products

Get Support for Your FLIR Products

Welcome to the FLIR Customer Support Center. This portal will help you as a FLIR customer to get the most out of your FLIR products. The portal gives you access to:

- The FLIR Knowledgebase
- Ask our support team (requires registration)
- Software and documentation (requires registration)
- FLIR service contacts

Find Answers
We store all resolved problems in our solution database. Search by product, category, keywords, or phrases.

Search by Keyword

[Search All Answers](#)

[See All Popular Answers](#)

To find a datasheet for a current product, click on a picture.
To find a datasheet for a legacy product, click [here](#).

FLIR Ex



FLIR Exx



FLIR Kxx



FLIR T4xx



FLIR T6xx



FLIR G3xx



ThermaCAM™
GasFindIR



FLIR GF3xx



FLIR AX



FLIR Ax5



FLIR A3xx



[More...](#)

Product catalog
Please right-click the links below and select Save Target As... to save the file.



[US Letter \(28 Mb\)](#)

[A4 \(27.4 Mb\)](#)

Accessories



[Important legal disclaimer, dangers, warnings, and cautions](#)

4.1 General

For customer help, visit:

<http://support.flir.com>

4.2 Submitting a question

To submit a question to the customer help team, you must be a registered user. It only takes a few minutes to register online. If you only want to search the knowledgebase for existing questions and answers, you do not need to be a registered user.

When you want to submit a question, make sure that you have the following information to hand:

- The camera model

- The camera serial number
- The communication protocol, or method, between the camera and your device (for example, SD card reader, HDMI, Ethernet, USB, or FireWire)
- Device type (PC/Mac/iPhone/iPad/Android device, etc.)
- Version of any programs from FLIR Systems
- Full name, publication number, and revision number of the manual

4.3 Downloads

On the customer help site you can also download the following, when applicable for the product:

- Firmware updates for your infrared camera.
- Program updates for your PC/Mac software.
- Freeware and evaluation versions of PC/Mac software.
- User documentation for current, obsolete, and historical products.
- Mechanical drawings (in *.dxf and *.pdf format).
- Cad data models (in *.stp format).
- Application stories.
- Technical datasheets.
- Product catalogs.

Important information about FLIR Kx series service

- Contact the service department before shipping the camera. Many problems can be resolved on the phone—if so, the camera does not need to be shipped.
- The camera must be thoroughly cleaned, decontaminated and disinfected before shipping to our service department. No hazardous residues are allowed on cameras. Such residues include—but are not limited to—chemical fire-extinguishing compounds, radioactivity, biohazardous materials, and residues from chemical fires.
- FLIR Systems reserves the right to charge the full cost for the decontamination and disinfection of contaminated cameras that are shipped to our service department.



Thank you for choosing a FLIR Kx series camera from FLIR Systems.

The FLIR Kx series is a robust and reliable infrared camera series designed to perform under extremely severe conditions. The FLIR Kx series camera has an intuitive interface with a design that makes it easy to control even with a gloved hand.

Main features:

- **Robust and reliable.** The FLIR Kx series is designed to meet tough operating conditions. It can withstand a drop from 2 m (6.5') onto a concrete floor, is water resistant to IP67, and is fully operational up to 55°C (135°F).
- **Innovative.** The FLIR Kx series utilizes our patented technology MSX, where a thermal sensor is combined with a visual camera sensor to give detailed image information in many user situations.
- **Easy-to-use.** The FLIR Kx series is easily used in a gloved professional hand. An intuitive and simple user interface allows you to focus on the job. The FLIR Kx series can be controlled by just one large button on top of the unit.

Quick start guide

Follow this procedure:

1. Charge the battery. You can do this in three different ways:

- Charge the battery using the FLIR stand-alone battery charger.
- Charge the battery using the FLIR power supply.
- Charge the battery using a USB cable connected to a computer.

Note Charging the camera using a USB cable connected to a computer takes *considerably* longer than using the FLIR power supply or the FLIR stand-alone battery charger.

2. Push the on/off button to turn on the camera.
3. Aim the camera toward the object of interest.

8.1 View from the front

8.1.1 Figure

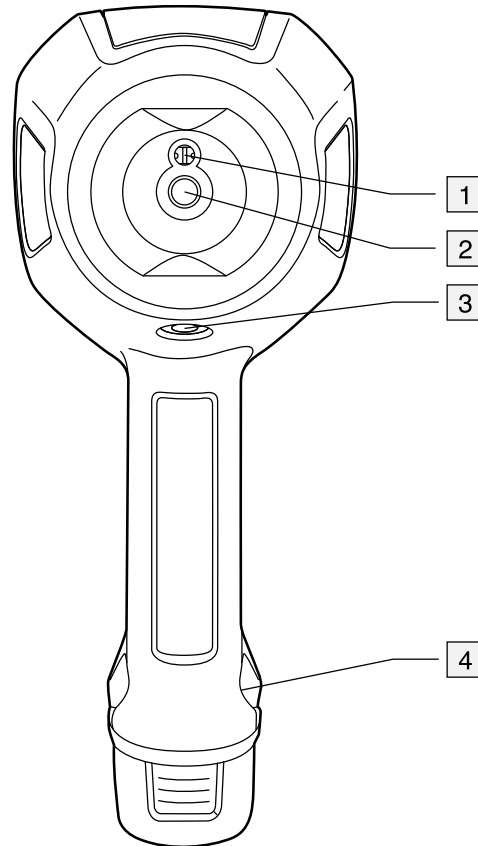

8.1.2 Explanation

1. Digital camera lens.
2. Infrared lens.
3. Tripod mount.
4. Attachment point for lanyard strap.

8.2 View from the rear

8.2.1 Figure

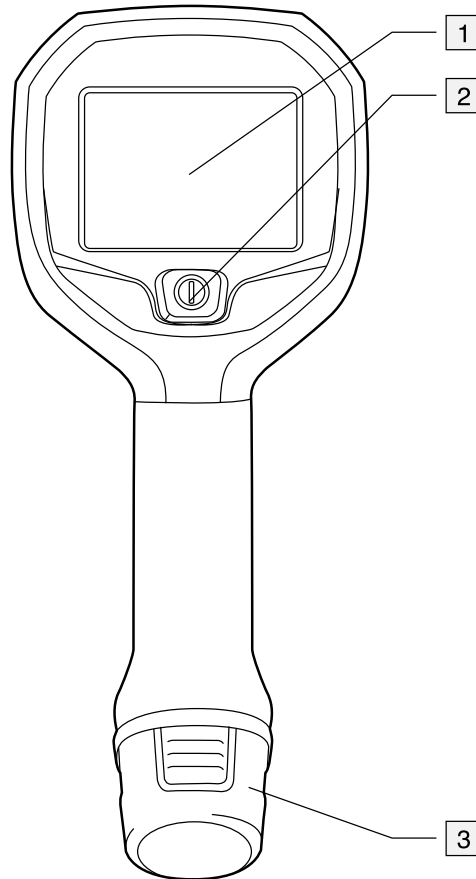

8.2.2 Explanation

1. Camera screen.
2. On/off button. This button has three functions:
 - Push the on/off button to turn on the camera.
 - Push and hold the on/off button for more than 3 seconds but less than 10 seconds to put the camera into standby mode. The camera then automatically turns off after 6 hours.
 - Push and hold the on/off button for more than 10 seconds to turn off the camera.
3. Battery.

8.3 Lanyard strap

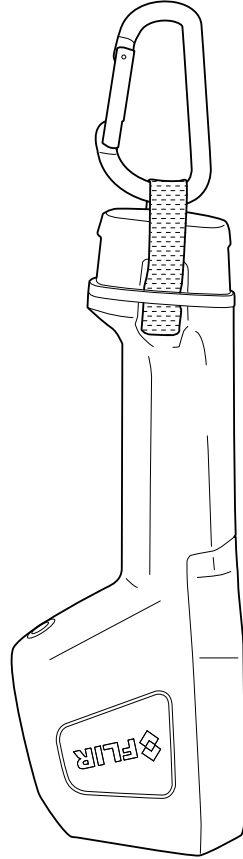

9.1 Figure



9.2 Explanation

1. Low-sensitivity range indicator.
2. Overheating indicator. The indicator provides a visual warning to the user that the thermal imager is about to shut down due to internal overheating.
3. Temperature scale.
4. Digital readout of the temperature at the position of the spotmeter.
5. Battery status indicator.
6. Camera mode indicator (e.g. *fire mode*).
7. Spotmeter.

Note The icons are displayed in green or blue, depending on the selected camera mode.

- The green icon color indicates that the camera is in a mode where it automatically switches between the high-sensitivity range and the low-sensitivity range, depending on the temperature of objects in the field of view.
- The blue icon color indicates that the camera is in a mode where the temperature range is locked to the high-sensitivity range.

10.1 Charging the battery

10.1.1 Charging the battery using the FLIR power supply

Follow this procedure:

1. Connect the power supply to a wall outlet.
2. Connect the power supply cable to the USB connector on the camera. To access the USB connector, see section 10.3 *Accessing the connector bay*, page 18.

Note The charging time for a fully depleted battery is 2 hours.

10.1.2 Charging the battery using the FLIR stand-alone battery charger.

Follow this procedure:

1. Connect the stand-alone battery charger to a wall outlet.
2. Remove the battery from the camera.

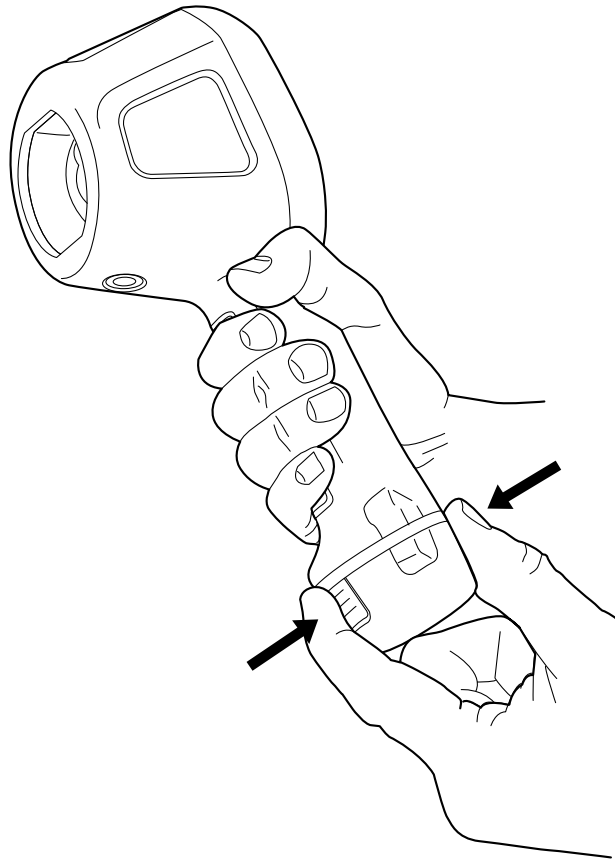

3. Put the battery into the stand-alone battery charger.

Note

- The charging time for a fully depleted battery is 2 hours.
- The battery is being charged when the blue LED is flashing.
- The battery is fully charged when the blue LED is continuous.

10.1.3 Charging the battery using a USB cable

Follow this procedure:

1. Connect the camera to a computer using a USB cable. To access the USB connector, see section 10.3 *Accessing the connector bay*, page 18.

Note

- To charge the camera, the computer must be turned on.
- Charging the camera using a USB cable connected to a computer takes *considerably* longer than using the FLIR power supply or the FLIR stand-alone battery charger.

10.2 Turning on and turning off the camera

- Push the on/off button to turn on the camera.
- Push and hold the on/off button for more than 3 seconds but less than 10 seconds to put the camera into standby mode. The camera then automatically turns off after 6 hours.
- Push and hold the on/off button for more than 10 seconds to turn off the camera.

10.3 Accessing the connector bay

10.3.1 Procedure

Follow this procedure:

1. Fold up the rubber cover at the top of the camera.

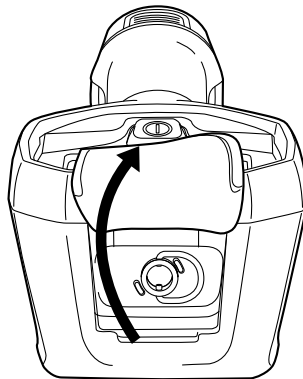

2. Hold the metal ring firmly.

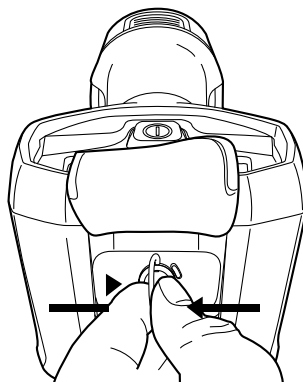

3. Turn the ring about 90° counter-clockwise.

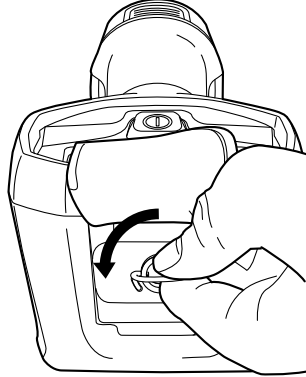

4. Pull out the plastic insert.

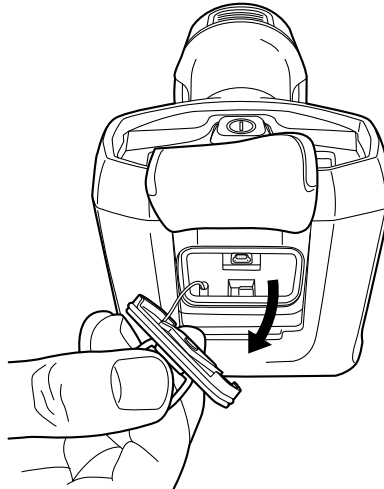
**CAUTION**

The plastic insert has an O-ring seal. Do not damage the O-ring seal.

10.4 Changing temperature unit

10.4.1 General

The camera displays temperatures in °C or °F. You change the temperature unit with a switch, located in the connector bay.

10.4.2 Procedure

Follow this procedure:

1. To access the temperature unit switch, see section 10.3 *Accessing the connector bay*, page 18.
2. Set the temperature unit switch to the desired position.

10.5 Changing settings (in FLIR Tools)

10.5.1 General

By connecting the camera to FLIR Tools, you get access to a variety of settings in the camera.

A download card for FLIR Tools is included in the transport case. Connect the camera to the computer using the USB cable. To access the USB connector, see section 10.3 *Accessing the connector bay*, page 18.

10.5.2 The *General settings* tab

10.5.2.1 *Figure*



10.5.2.2 *Explanation*

Firmware info area: To check whether a newer version of the camera firmware exists, click *Check for updates*, and follow the on-screen instructions.

Restore to factory default area: To restore all camera settings to the factory defaults, click *Restore*.

10.5.3 The User interface tab

10.5.3.1 Figure



10.5.3.2 Explanation

Camera modes area: To define which camera modes to enable in the camera, select the camera mode. For more information on each camera mode, see section 10.5.4.2 *Explanation of the different camera modes*, page 22.

Gain mode area:

- **Auto gain mode:** Select to make the camera automatically switch between the high-sensitivity range and the low-sensitivity range, depending on the scene temperature. The temperature level at which the camera switches between the two modes is +150°C (+302°F).
- **Low gain mode:** Select to make the camera work in the low-sensitivity range only. This has the advantage that the camera does not perform a non-uniformity correction when an object with a temperature higher than +150°C (+302°F) enters the scene. However, the disadvantage is lower sensitivity and a higher level of signal noise.

Add custom boot image area: To specify your own unique image to appear during start-up, click *Browse*, and navigate to the image file. This is useful for, for example, identifying your fire department's cameras. By incorporating your fire department's logo, and a unique identity number in the image, you can keep track of your cameras.

10.5.4 Camera modes

10.5.4.1 General

The FLIR Kx series features seven different camera modes:

1. Basic mode.
2. Black and white firefighting mode.

3. Fire mode.
4. Search and rescue mode.
5. Heat detection mode.
6. Cold detection mode.
7. Building analysis mode.

Each mode is optimized for a certain type of firefighting application. The modes also differ in the following ways:

- Modes with green icons (1–3 in the list): The camera switches between the high-sensitivity range (-20 to $+150^{\circ}\text{C}$ (-4 to $+302^{\circ}\text{F}$)) and the low-sensitivity range (0 to $+500^{\circ}\text{C}$ ($+32$ to $+932^{\circ}\text{F}$)) automatically when an object with a temperature above 150°C (302°F), covering more than 2% of the image, enters the field of view of the camera.
- Modes with blue icons (4–7 in the list): The temperature range is locked to the high-sensitivity range (-20 to $+150^{\circ}\text{C}$ (-4 to $+302^{\circ}\text{F}$)). This is useful if you need to maintain the best possible image for objects with a temperature below 150°C (302°F), even if there are objects with a temperature above 150°C (302°F) in the field of view of the camera.

10.5.4.2 Explanation of the different camera modes

10.5.4.2.1 Basic mode



Figure 10.1 Basic mode.

The Basic mode is the default mode of the camera. It is a multipurpose mode for the initial fire attack with life rescuing operation and control of the fire. The camera automatically switches between the high-sensitivity range and the low-sensitivity range, to maintain an optimal infrared image while at the same time maintaining a safe and consistent heat colorization of the fire scene.

- Automatic range.
- Colorization of heat: $+150$ to $+500^{\circ}\text{C}$ ($+302$ to $+932^{\circ}\text{F}$).
- High-sensitivity range: -20 to $+150^{\circ}\text{C}$ (-4 to $+302^{\circ}\text{F}$).
- Low-sensitivity range: 0 to $+500^{\circ}\text{C}$ ($+32$ to $+932^{\circ}\text{F}$).

10.5.4.2.2 Black and white firefighting mode



Figure 10.2 Black and white firefighting mode.

The *black and white firefighting mode* is a standardized firefighting mode based on the Basic mode. It is a multipurpose mode for the initial fire intervention that includes life rescuing operations and control of the fire. It is specifically designed for fire services that do not want to use the heat colorization feature.

The camera automatically switches between the high-sensitivity range and the low-sensitivity range, to maintain an optimal infrared image.

- Automatic range.
- High-sensitivity range: -20 to $+150^{\circ}\text{C}$ (-4 to $+302^{\circ}\text{F}$).
- Low-sensitivity range: 0 to $+500^{\circ}\text{C}$ ($+32$ to $+932^{\circ}\text{F}$).

10.5.4.2.3 Fire mode



Figure 10.3 Fire mode.

The *fire mode* is similar to the Basic mode, but with a higher-temperature starting point for the heat colorization. It is suitable for fire scenes with higher background temperatures, where there are already a lot of open flames and a high background temperature. The camera automatically switches between the high-sensitivity range and the low-sensitivity range, to maintain an optimal infrared image while at the same time maintaining a safe and consistent heat colorization.

- Automatic range.

- Colorization of heat: +250 to +500°C (+ 482 to +932°F).
- High-sensitivity range: -20 to +150°C (-4 to +302°F).
- Low-sensitivity range: 0 to +500°C (+32 to +932°F).

10.5.4.2.4 Search and rescue mode



Figure 10.4 Search and rescue mode.

The *search and rescue mode* is optimized for maintaining high contrast in the infrared image while searching for people in landscapes, buildings, or traffic accident scenes.

- High-sensitivity range only.
- Colorization of heat: +100 to +150°C (+212 to +302°F).
- High-sensitivity range: -20 to +150°C (-4 to +302°F).

10.5.4.2.5 Heat detection mode

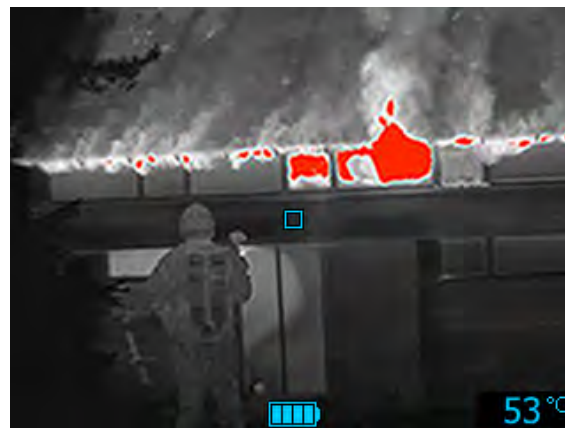

Figure 10.5 Heat detection mode.

The *heat detection mode* is optimized for searching hotspots during overhaul after the fire is out—typically to ensure that there is no remaining hidden fire. This mode can also be used to find thermal patterns (e.g., signs of people in car seats after accidents), to ensure that everyone has been found. This mode can also be used to search for people in water and open landscapes.

- High-sensitivity range only.
- Colorization of heat: the 20% highest temperatures in the scene.

- High-sensitivity range: -20 to $+150^{\circ}\text{C}$ (-4 to $+302^{\circ}\text{F}$).

10.5.4.2.6 Cold detection mode



Figure 10.6 Cold detection mode.

The *cold detection mode* is optimized for searching coldspots—typically to find drafts and air flows.

- High-sensitivity range only.
- Colorization of cold: the 20% lowest temperatures in the scene.
- High-sensitivity range: -20 to $+150^{\circ}\text{C}$ (-4 to $+302^{\circ}\text{F}$).

10.5.4.2.7 Building analysis mode

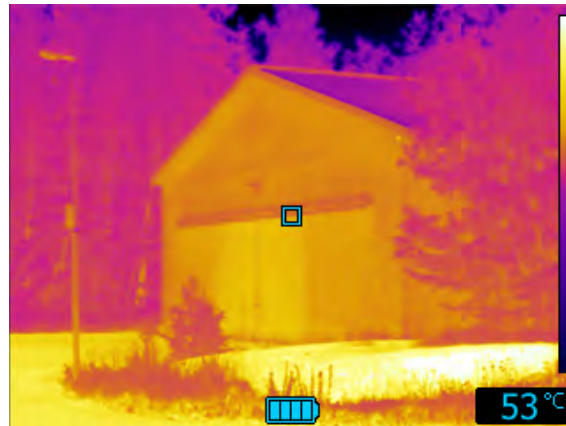

Figure 10.7 Building analysis mode.

The *building analysis mode* is suitable for the analysis of buildings and the detection of building-related anomalies. The thermal image can provide information on structural, mechanical, plumbing, and electrical constructions as well as an indication of moisture, wetness, and air infiltration.

In this mode, the camera uses an iron color palette to display the different temperatures, where black, blue, and purple are for the coldest areas, followed by red, orange, and yellow for the mid-range and going to white for the hottest parts. The temperature scale is automatically adjusted to the thermal content of the image.

10.6 Updating the camera

10.6.1 General

To take advantage of the latest FLIR camera firmware, it is important that you keep your camera updated. You update your camera using FLIR Tools, see section 10.5 *Changing settings (in FLIR Tools)*, page 20.

Table of contents

11.1	Online field-of-view calculator.....	27
11.2	Note about technical data.....	27
11.3	Note about authoritative versions.....	27
11.4	FLIR K2	28

11.1 Online field-of-view calculator

Please visit <http://support.flir.com> and click the photo of the camera series for field-of-view tables for all lens-camera combinations.

11.2 Note about technical data

FLIR Systems reserves the right to change specifications at any time without prior notice. Please check <http://support.flir.com> for latest changes.

11.3 Note about authoritative versions

The authoritative version of this publication is English. In the event of divergences due to translation errors, the English text has precedence.

Any late changes are first implemented in English.

11.4 FLIR K2

P/N: 73701-0101

Rev.: 39875

General description	
The FLIR K2 is a robust and reliable infrared camera designed to perform under extremely severe conditions. The FLIR K2 has an intuitive interface with a design that makes it easy to control even with a gloved hand.	
Benefits:	
<ul style="list-style-type: none"> • Robust and reliable: The FLIR K2 is designed to meet tough operating conditions. It can withstand a drop from 2 m (6.5 ft.), is water resistant to IP67, and is fully operational up to 55°C (135°F), and operational up to +85°C (+185°F) for 15 minutes, +150°C (+302°F) for 10 minutes, and +260°C (+500°F) for 3 minutes. • Innovative: The FLIR K2 utilizes our patented technology MSX, where a thermal sensor is combined with a visual camera sensor to give detailed image information in many user situations. • Easy-to-use: Easily used in a gloved professional hand. An intuitive and simple user interface allows you to focus on the job. The FLIR K2 can be controlled by just one large button on top of the unit. 	
Typical applications:	
<ul style="list-style-type: none"> • Heat detection. • Search and rescue. • Final extinction. • Back-up camera. • Scanning camera. • Fire attack. 	
Imaging and optical data	
IR resolution	160 × 120 pixels
Thermal sensitivity/NETD	< 100 mK @ +30°C (+86°F)
Field of view (FOV)	47° × 35°
Depth of field	0.1 m (0.33 ft.), infinity
Focal length	1.9 mm (0.075 in.)
Spatial resolution (IFOV)	6.22 mrad
F-number	1.1
Image frequency	9 Hz
Focus	Fixed
Detector data	
Detector type	Focal plane array, uncooled microbolometer
Spectral range	7.5–13 μm
Pitch	12 μm
Visual camera	
Built-in digital camera	640 × 480 pixels
Digital camera, FOV	73° × 61°, adapts to the IR lens
Sensitivity	Minimum 10 lux

Technical data

Image presentation	
Display	3 in. LCD, 320 x 240 pixels, backlit
Auto range	Auto, non-selectable
Image presentation modes	
Image modes	<ul style="list-style-type: none"> • Basic fire-fighting mode (default) • Black-and-white fire-fighting mode • Fire mode • Search-and-rescue mode • Heat detection mode • Cold detection mode • Building analysis mode
	<div style="border: 1px solid black; padding: 5px;">  NOTE The image mode can only be changed using FLIR Tools. </div>
Multi Spectral Dynamic Imaging (MSX)	Yes
Measurement	
Object temperature range	<ul style="list-style-type: none"> • -20°C to +150°C (-4°F to +302°F) • 0°C to +500°C (+32°F to +932°F)
Accuracy	±4°C (±7.2°F) or ±4% for ambient temperatures of 10–35°C (50–95°F)
Measurement analysis	
Spotmeter	1
Automatic hot detection	Heat detection mode (the hottest 20% of the of scene is colorized)
Isotherm	Yes
USB	
USB	USB Micro-B
Compatibility	
Compatible with FLIR software	FLIR Tools
Data communication interfaces	
Interfaces	Update from PC devices
Power system	
Battery type	Li ion
Battery voltage	3.6 V
Battery capacity	2.6 Ah at 20–25°C (68–77°F)
Battery operating time	Approximately 4 hours at +25°C (+77°F) ambient temperature and typical use
Charging system	Battery is charged inside the camera or in a dedicated charger
Charging time	2.5 h to 90% capacity, charging status indicated by LEDs
Charging temperature	0–45°C (32–113°F)
Power management	Automatic shutdown and sleep mode

Technical data

Power system	
Start-up time from sleep mode	10 seconds
Start-up time	30 seconds
Environmental data	
Operating temperature range	<ul style="list-style-type: none"> -10°C to +55°C (+14°F to +131°F): infinity +85°C (+185°F): 15 minutes +150°C (+302°F): 10 minutes +260°C (+500°F): 3 minutes
Storage temperature range	-40°C to +70°C (-40°F to +158°F)
Humidity (operating and storage)	IEC 60068-2-30, 24 hours, 95% relative humidity, 25–40°C (77–104°F), 2 cycles
Relative humidity	95% relative humidity, 25–40°C (77–104°F), non-condensing
EMC	<ul style="list-style-type: none"> EN 61000-6-2:2005 (immunity) EN 61000-6-3:2011 (emission) FCC 47 CFR Part 15 B (emission)
Magnetic fields	EN 61 000-4-8, test level 5 for continuous field (severe industrial environment)
Encapsulation	IP 67 (IEC 60529)
Corrosion	ASTM B117, salt spray, 5% saline solution in 48 hours and +35°C
Shock	25 g (IEC 60068-2-27)
Vibration	2 g (IEC 60068-2-6)
Drop	2 m (6.6 ft.)
Safety (power supply)	CE/EN/UL/CSA/PSE 60950-1
Physical data	
Camera weight, incl. battery	0.7 kg (1.54 lb.)
Battery weight	0.119 kg (0.26 lb.)
Camera size (L x W x H)	250 mm x 105 mm x 90 mm (9.8 in. x 4.1 in. x 3.5 in.)
Tripod mounting	UNC ¼"-20
Material	<ul style="list-style-type: none"> PPSU Silicon rubber Aluminium, cast Flame-resistant magnesium alloy
Shipping information	
List of contents	<ul style="list-style-type: none"> Infrared camera Battery (x2) Battery charger Lanyard strap Power supply Printed documentation USB cable
Packaging, weight	<ul style="list-style-type: none"> 1-pack: 2.06 kg (4.5 lb.) 5-pack: 11.2 kg (24.7 lb.)

Shipping information	
Packaging, size	<ul style="list-style-type: none"> • 1-pack: 323 × 325 × 110 mm (12.7 × 12.8 × 4.3 in.) • 5-pack: 578 × 336 × 351 mm (22.93 × 13.10 × 13.68 in.)
EAN-13	4743254002050
UPC-12	845188011345
Country of origin	Estonia

Supplies & accessories:

- T198532; Car charger
- T198533; USB cable Std A <-> Micro B
- T127722ACC; Retractable lanyard
- T199127; Li-Ion Battery pack 3.6 V 2.6 Ah
- T199128; Battery charger, incl. power supply with multi plugs
- T199423ACC; Battery Li-ion 3.6 V, 2.6 Ah, 9.4 Wh
- T199414; In-truck charger
- T199130; Lanyard strap
- T199357; Hard transport case

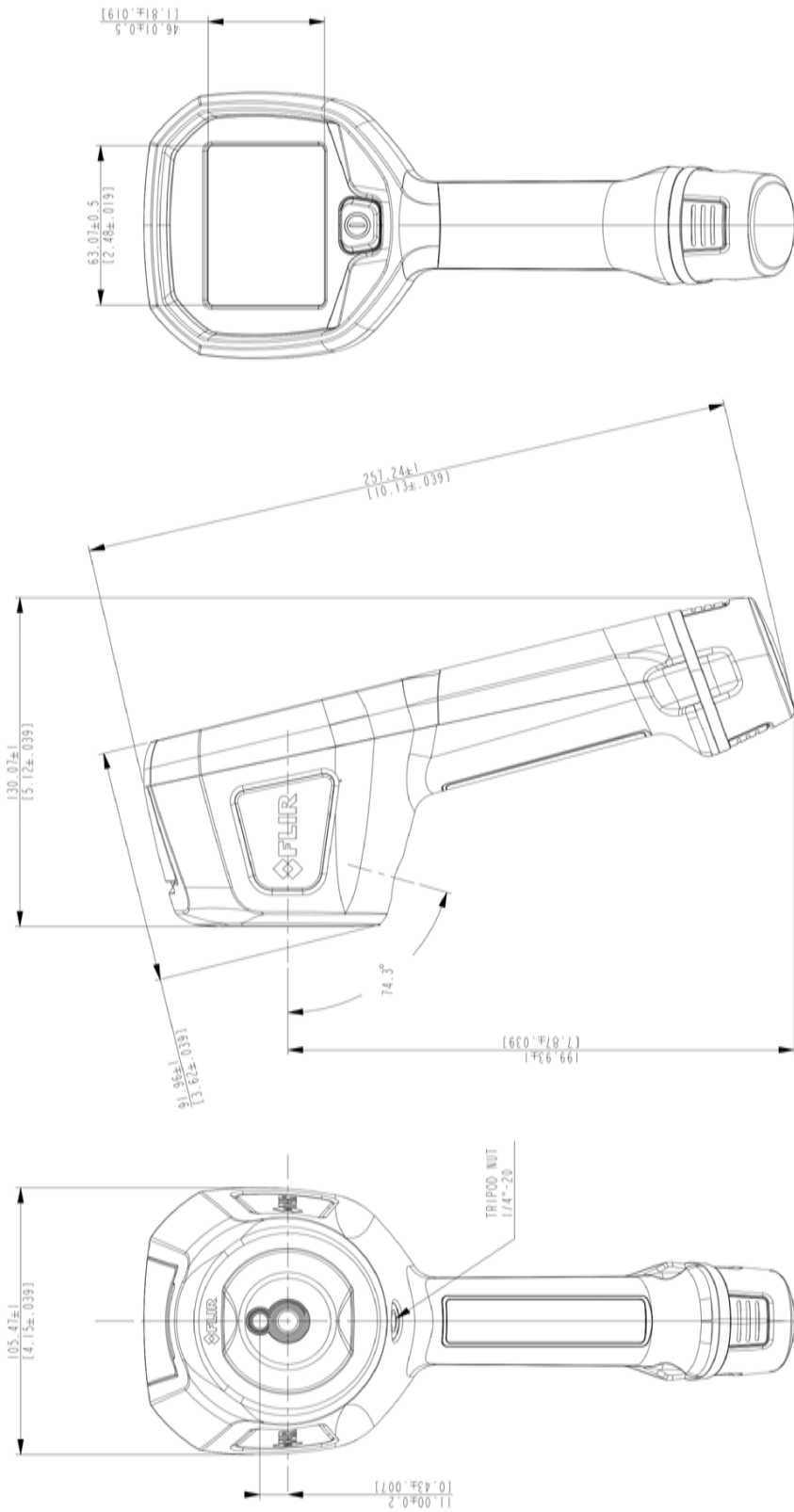

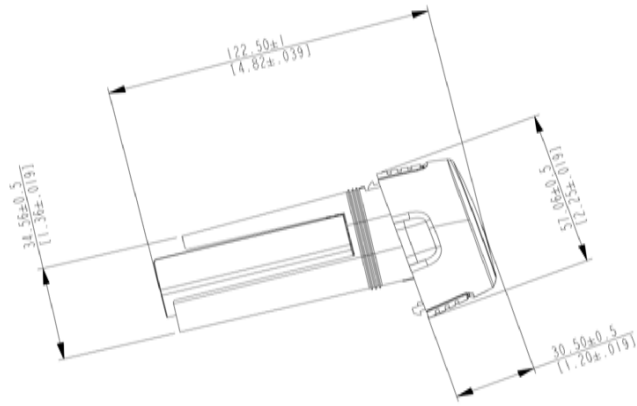
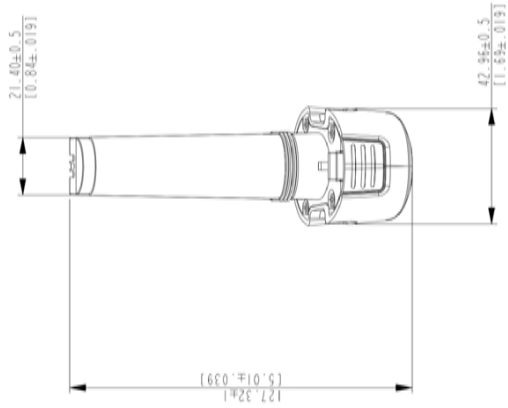

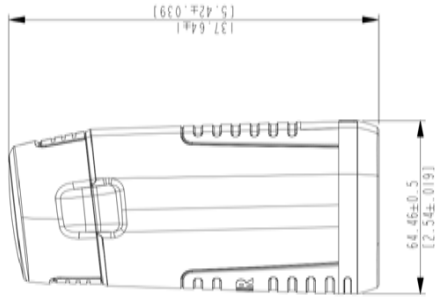
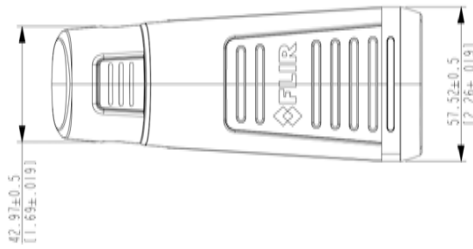

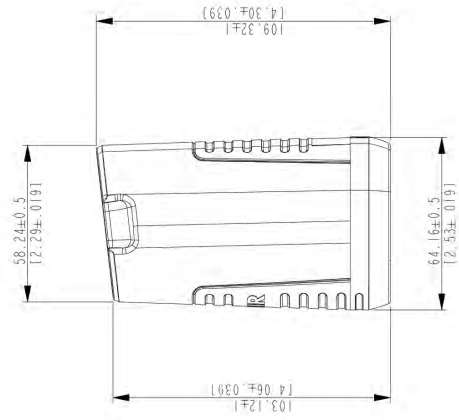
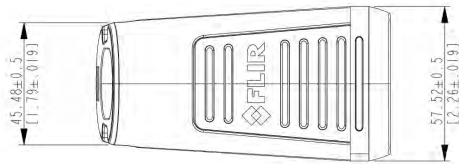
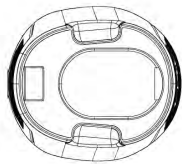



The World's Sixth Sense™

October 26, 2016

AQ320200

CE Declaration of Conformity

This is to certify that the System listed below has been designed and manufactured to meet the requirements, as applicable, of the following EU-Directives and corresponding harmonizing standards. The systems consequently meet the requirements for the CE-mark.

Directives:

Directive 2014/30/EU:

Electromagnetic Compatibility

Directive 2011/65/EU:

Restriction of the use of certain hazardous substances in electrical and electronic equipment (RoHS recast)

Standards:

Emission:

EN 61000-6-3

**Electromagnetic Compatibility
Generic standards - Emission**

Immunity:

EN 61000-6-2

**Electromagnetic Compatibility
Generic standards - Immunity**

RoHS:

EN 50581

Technical documentation for the assessment of electrical and electronic products with respect to the restriction of hazardous substances

System:

KX-series

FLIR Systems AB
Quality Assurance

Björn Svensson
Director, Quality Assurance

14.1 Camera housing, cables, and other items

14.1.1 Liquids

Use one of these liquids:

- Warm water
- A weak detergent solution

14.1.2 Equipment

A soft cloth

14.1.3 Procedure

Follow this procedure:

1. Soak the cloth in the liquid.
2. Twist the cloth to remove excess liquid.
3. Clean the part with the cloth.



CAUTION

Do not apply solvents or similar liquids to the camera, the cables, or other items. This can cause damage.

14.2 Infrared lens

14.2.1 Liquids

Use one of these liquids:

- A commercial lens cleaning liquid with more than 30% isopropyl alcohol.
- 96% ethyl alcohol (C₂H₅OH).

14.2.2 Equipment

Cotton wool

14.2.3 Procedure

Follow this procedure:

1. Soak the cotton wool in the liquid.
2. Twist the cotton wool to remove excess liquid.
3. Clean the lens one time only and discard the cotton wool.



WARNING

Make sure that you read all applicable MSDS (Material Safety Data Sheets) and warning labels on containers before you use a liquid: the liquids can be dangerous.



CAUTION

- Be careful when you clean the infrared lens. The lens has a delicate anti-reflective coating.
- Do not clean the infrared lens too vigorously. This can damage the anti-reflective coating.

FLIR Systems was established in 1978 to pioneer the development of high-performance infrared imaging systems, and is the world leader in the design, manufacture, and marketing of thermal imaging systems for a wide variety of commercial, industrial, and government applications. Today, FLIR Systems embraces five major companies with outstanding achievements in infrared technology since 1958—the Swedish AGEMA Infrared Systems (formerly AGA Infrared Systems), the three United States companies Indigo Systems, FSI, and Inframetrics, and the French company Cedicp.

Since 2007, FLIR Systems has acquired several companies with world-leading expertise in sensor technologies:

- Exttech Instruments (2007)
- Ifara Tecnologías (2008)
- Salvador Imaging (2009)
- OmniTech Partners (2009)
- Directed Perception (2009)
- Raymarine (2010)
- ICx Technologies (2010)
- TackTick Marine Digital Instruments (2011)
- Aerius Photonics (2011)
- Lorex Technology (2012)
- Traficon (2012)
- MARSS (2013)
- DigitalOptics micro-optics business (2013)
- DVTEL (2015)
- Point Grey Research (2016)
- Prox Dynamics (2016)

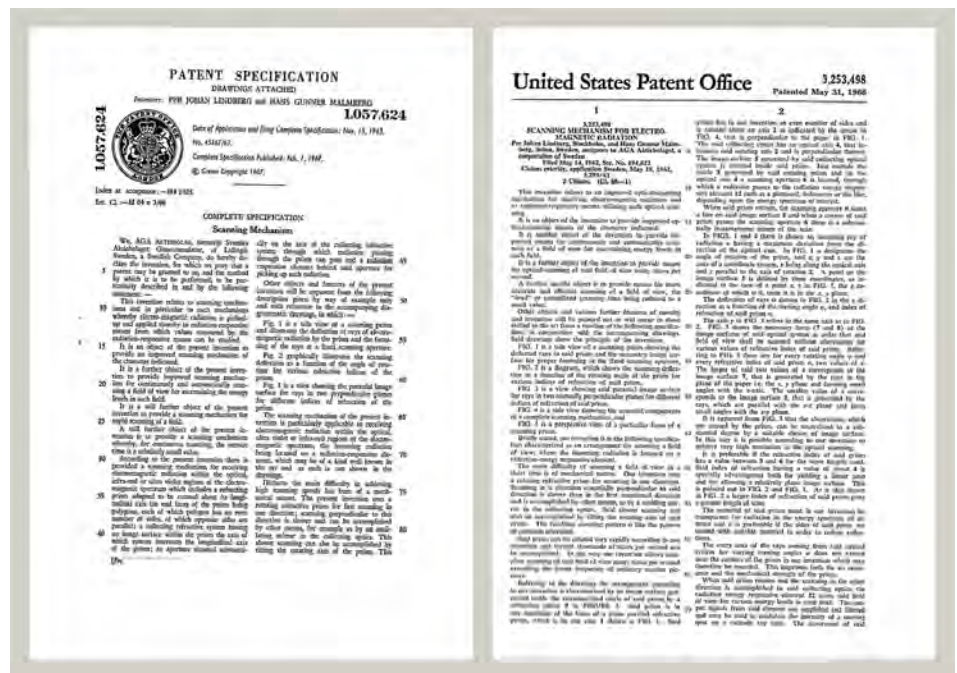

Figure 15.1 Patent documents from the early 1960s

FLIR Systems has three manufacturing plants in the United States (Portland, OR, Boston, MA, Santa Barbara, CA) and one in Sweden (Stockholm). Since 2007 there is also a

manufacturing plant in Tallinn, Estonia. Direct sales offices in Belgium, Brazil, China, France, Germany, Great Britain, Hong Kong, Italy, Japan, Korea, Sweden, and the USA— together with a worldwide network of agents and distributors—support our international customer base.

FLIR Systems is at the forefront of innovation in the infrared camera industry. We anticipate market demand by constantly improving our existing cameras and developing new ones. The company has set milestones in product design and development such as the introduction of the first battery-operated portable camera for industrial inspections, and the first uncooled infrared camera, to mention just two innovations.



Figure 15.2 1969: Thermovision Model 661. The camera weighed approximately 25 kg (55 lb.), the oscilloscope 20 kg (44 lb.), and the tripod 15 kg (33 lb.). The operator also needed a 220 VAC generator set, and a 10 L (2.6 US gallon) jar with liquid nitrogen. To the left of the oscilloscope the Polaroid attachment (6 kg/13 lb.) can be seen.



Figure 15.3 2015: FLIR One, an accessory to iPhone and Android mobile phones. Weight: 90 g (3.2 oz.).

FLIR Systems manufactures all vital mechanical and electronic components of the camera systems itself. From detector design and manufacturing, to lenses and system electronics, to final testing and calibration, all production steps are carried out and supervised by our own engineers. The in-depth expertise of these infrared specialists ensures the accuracy and reliability of all vital components that are assembled into your infrared camera.

15.1 More than just an infrared camera

At FLIR Systems we recognize that our job is to go beyond just producing the best infrared camera systems. We are committed to enabling all users of our infrared camera systems to work more productively by providing them with the most powerful camera–software combination. Especially tailored software for predictive maintenance, R & D, and process monitoring is developed in-house. Most software is available in a wide variety of languages.

We support all our infrared cameras with a wide variety of accessories to adapt your equipment to the most demanding infrared applications.

15.2 Sharing our knowledge

Although our cameras are designed to be very user-friendly, there is a lot more to thermography than just knowing how to handle a camera. Therefore, FLIR Systems has founded the Infrared Training Center (ITC), a separate business unit, that provides certified training courses. Attending one of the ITC courses will give you a truly hands-on learning experience.

The staff of the ITC are also there to provide you with any application support you may need in putting infrared theory into practice.

15.3 Supporting our customers

FLIR Systems operates a worldwide service network to keep your camera running at all times. If you discover a problem with your camera, local service centers have all the equipment and expertise to solve it within the shortest possible time. Therefore, there is no need to send your camera to the other side of the world or to talk to someone who does not speak your language.