

Instruction manual

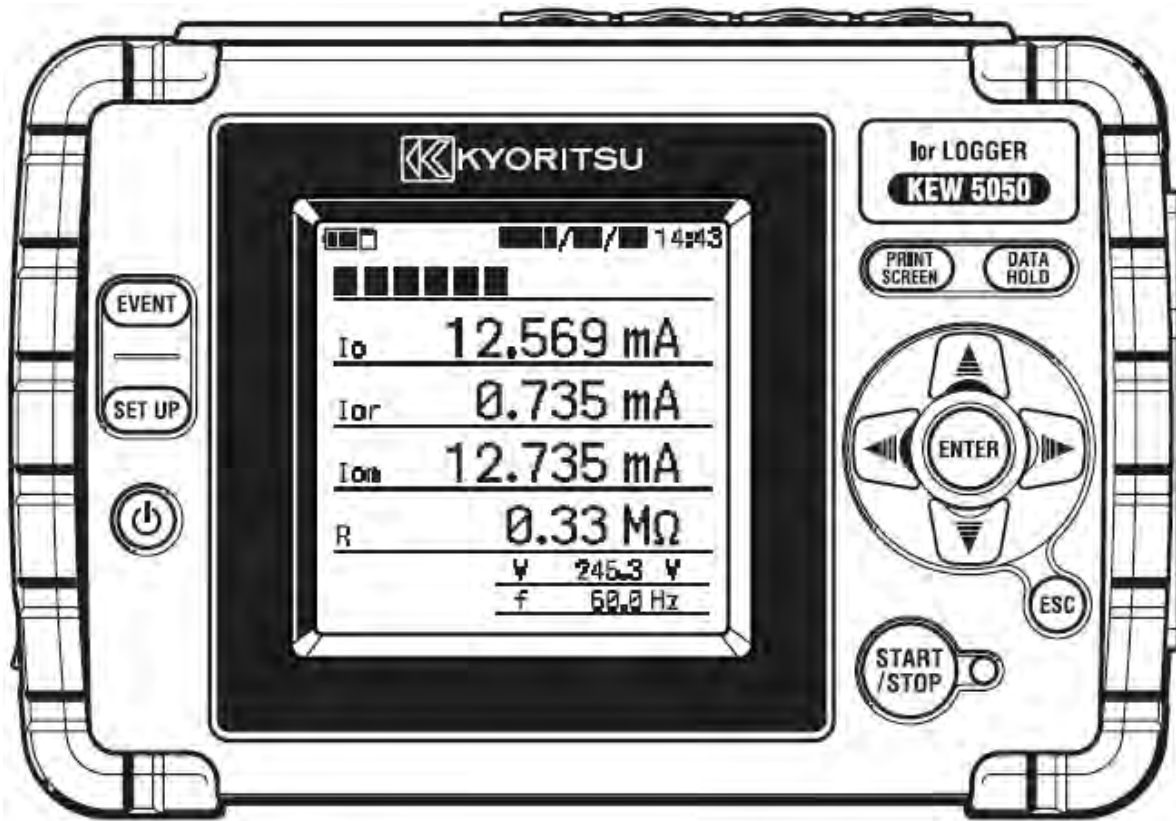

Ior LEAKAGE CURRENT LOGGER

KEW 5050



KYORITSU ELECTRICAL INSTRUMENTS WORKS, LTD.

Contents

Unpacking procedure	5
Safety warnings	7
1. Functional overview	11
1.1 Features	11
1.2 Constructional drawing	12
1.3 Steps for measurement	13
2. Product layout	14
2.1 Display(LCD)/ Keys	14
2.2 Connector	15
2.3 Side face	16
2.4 Voltage test lead and clamp sensor	17
3. Basic operations	18
3.1 Keys	18
3.2 Icons on LCD	19
3.3 Symbols on LCD	19
3.4 Screens	20
Rough chart of available screens	20
Measured value (vector)	21
Event	22
Settings	23
4. Leakage current	24
4.1 Leakage current (Io) measurement	24
4.2 Resistive leakage current (Ior) measurement	25
Single-phase 2-wire	25
Single-phase 3-wire	25
Three-phase 3-wire	26
Three-phase 4-wire	26
Ior measurement on wiring with different capacities	27
5. Getting started	27
5.1 Attaching markers to clamp sensors	27
5.2 Power supply	27
Battery	27
How to install batteries	28
The battery indicator/ AC power icon	29
AC adapter	30
AC adapter connection	31

5.3	Placing/ removing SD card	32
	Inserting SD card	32
	Removing SD card	32
5.4	Voltage test lead and Clamp sensor connection	33
5.5	Start KEW5050	34
	Start-up screen	34
	Cautionary message	34
5.6	Connection to the measured object	35
	Connection method (Selecting wiring system: Wiring diagram)	36
5.7	Recording procedure	38
	How to start recording	38
	How to stop recording	38
6.	Settings	39
	Moving the highlighted cursor	39
6.1	Detail settings	40
6.2	Basic setting	41
	Sensor recognition	41
	Current clamp sensor/ ch	42
	Frequency	45
6.3	Event setting	45
	Common settings to all events	45
	Upper threshold value (H)/ ch	46
	Lower threshold value (L)	48
	Peak threshold value (Pk)/ch	50
6.4	Recording setting	53
	Recording method	53
	Possible recording time	56
6.5	Saved data	57
	Recorded data	57
	KEW5050 settings	59
	Types of saved data	61
6.6	Others	63
	Environmental settings	63
	KEW5050 system settings	64
7.	Displayed Items	67
7.1	Measured values	67
	Displaying vector diagram	68
	Displaying measured values of entire system	69
7.2	Event	71
	Displaying information on occurred event	71

8.	Other functions.....	75
9.	Device connection.....	77
9.1	Data transfer to PC	77
9.2	Signal control	78
	Connection to output terminal	78
9.3	Getting power from measured line	79
10.	PC software for setting and data analysis.....	80
11.	Specifications.....	81
11.1	Safety requirements.....	81
11.2	General specification	81
11.3	Measurement specification	83
	Instantaneous events to be measured	84
	Items to be calculated	85
	Event items	88
12.	Troubleshooting	89
12.1	General troubleshooting.....	89
12.2	Input and display items	91
12.3	Error messages and actions	91

Unpacking procedure

We thank you for purchasing our **KEW5050** for **LEAKAGE CURRENT LOGGER**. Please check all the items listed below are included in the box.

1	Main unit	KEW5050	: 1 pce
2	Voltage test lead	MODEL7273	: One set with alligator clip (red & black, 1 pce. each)
3	Power cord	MODEL7170	: 1 pce
4	AC adapter	MODEL8262	: 1 pce
5	Earth cable	MODEL7278	: 1 pce
6	USB cable	MODEL7219	: 1 pce
7	SD card (2GB)	1 pce	
8	CD-ROM	PC software	: 1 pce
9	Battery	Alkaline size AA battery (LR6)	: 6 pcs
10	Carrying bag	MODEL9125	: 1 pce
11	Cable marker	4 colors x 2 pcs each (red, yellow, blue, green)	
12	Instruction manual	1 pce	
13	Software installation manual	1 pce	

1. Main unit

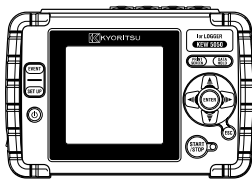

2. Voltage test lead

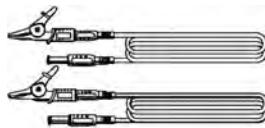

3. Power cord

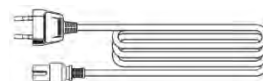

4. AC adapter



5. Earth cable

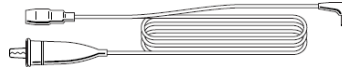

6. USB cable

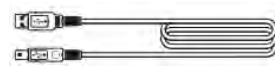

7. SD card (2GB)

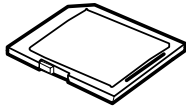

8. CD-ROM



9. Battery



10. Carrying bag

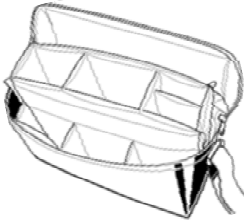

11. Cable marker

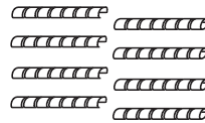

12. Instruction manual



13. Software installation manual



<Storage>

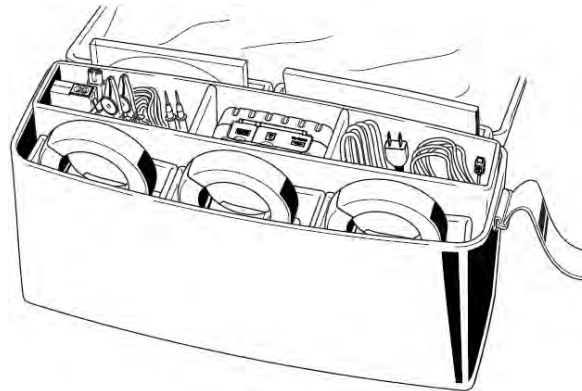

- In case any of the items listed above are found to be damaged or missing, or if the printing is unclear, please contact your local KYORITSU distributor.

Optional accessories

1	Ior leakage clamp sensor	KEW8177	(10 A/ Ø40mm)
		KEW8178	(10 A/ Ø68mm)
2	Power adapter	MODEL8329 (CAT III 150 V, CAT II 240 V)	

1. Ior leakage clamp sensor

2. Power adapter

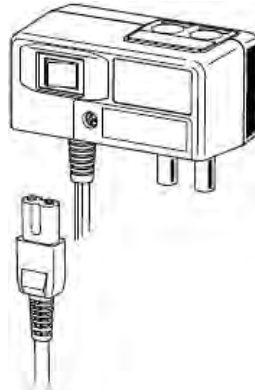
KEW8177
(Ø 40 mm)KEW8178
(Ø 68 mm)

Safety warnings

KEW5050 Ior Leakage current logger (Product) has been designed, manufactured and tested according to IEC 61010: Safety requirements for Electronic Measuring apparatus, and delivered in the best condition after passing quality control tests. **This instruction manual contains warnings and safety procedures which have to be observed by the user to ensure safe operation of the Product and to maintain it in safe condition. Therefore, read through these operating instructions before starting to use the Product.**



WARNING

- For about instruction manual –

- Read through and understand the instructions contained in this manual before starting to use the Product.
- Keep the manual at hand to enable quick reference whenever necessary.
- The Product is to be used only in its intended applications.
- Understand and follow all the safety instructions contained in the manual.
- Read the instruction manual for clamp sensor after reading this instruction manual.

It is essential that the above instructions are adhered to. Failure to follow the above instructions may cause injury or damage the Product, and/or damage the equipment under test. Kyoritsu assumes no responsibility for damage and injury caused by misuse or not following the instructions in the manual.

The symbol  indicated on the Product, means that the user must refer to the related parts in the manual for safe operation of the Product. It is essential to read the instructions wherever the symbol appears in the manual.

-  **DANGER:** is reserved for conditions and actions that are likely to cause serious or fatal injury.
-  **WARNING:** is reserved for conditions and actions that can cause serious or fatal injury.
-  **CAUTION:** is reserved for conditions and actions that can cause injury or instrument damage.

Measurement Category

To ensure safe operation of measuring instruments, IEC 61010 establishes safety standards for various electrical environments, categorized as O to CAT IV, and called measurement categories. Higher-numbered categories correspond to electrical environments with greater momentary energy, so a measuring instrument designed for CAT III environments can endure greater momentary energy than one designed for CAT II.

O (None, other) : Circuits which are not directly connected to the mains power supply.

CAT II : Electrical circuits of equipment connected to an AC electrical outlet by a power cord.

CAT III : Primary electrical circuits of the equipment connected directly to the distribution panel, and feeders from the distribution panel to outlets.

CAT IV : The circuit from the service drop to the service entrance, and to the power meter and primary overcurrent protection device (distribution panel).

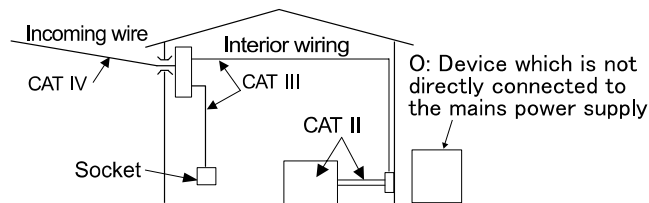

DANGER

- The Product is to be used only in its intended applications or conditions. Otherwise, safety functions equipped with the Product doesn't work, and instrument damage or serious personal injury may occur. Verify proper operation on a known source before taking action as a result of the indication of the Product.
 - With attention to the measurement category to which the object under test belongs, do not make measurements on a circuit in which the electrical potential exceeds the following values.
 - * 300 V AC for CAT IV, 600 V AC for CAT III
 - Do not attempt to make measurement in the presence of flammable or explosive gasses, or in steam environment.
 - Never attempt to use the Product if its surface or your hand is wet.
- Measurement -**
- Do not exceed the maximum allowable input of any measuring range.
 - Never open the battery compartment cover during a measurement.

 **DANGER****- Voltage test lead -**

- Use only the ones supplied with the Product.
- When the Product and the test lead are combined and used together, whichever lower category either of them belongs to is applied. Confirm that the measured voltage rating of the test lead is not exceeded.
- Connect voltage test leads to the Product first, and only then connect them to the circuit under test.
- Keep your fingers behind the barrier* during a measurement.

* Barrier provides protection against electrical shock and ensures the minimum required air and creepage distances.

- Never disconnect the voltage test leads from the connectors of the Product during a measurement (while the Product is energized).
- Do not touch two lines under test with the metal tips of the test leads.
- Never touch the metal tips of the test leads.

- Clamp sensor -

- Use only the ones designed specially for the Product.
- Ensure that sensor rating is appropriate for a current to be measured; voltage rating of the circuit under test should not exceed the maximum rated voltage.
- For leakage clamp sensors (KEW8177/ 8178) are rated to CAT III 300 V. The reference voltage input terminals on the Product is rated to CAT IV 300 V, CAT III 600 V. The lower category rating is applied when using these sensors with the Product; be careful not to exceed CAT III 300 V.
- Connect the sensors only required for the testing.
- Connect sensors to the Product first, and only then connect them to the circuit under test.
- Keep your fingers behind the barrier* during a measurement.

* Barrier provides protection against electrical shock and ensures the minimum required air and creepage distances.

- Never disconnect the sensors from the connectors of the Product during a measurement (while the Product is energized).
- Connect to the secondary side of a circuit breaker; the primary side may have large current capacity and may cause danger.
- Do not touch two lines under test with the metal tips of the jaw.

- Battery -

- Do not try to replace batteries during a measurement.

- AC adapter –

- Ensure that the power cord and the AC adapter are firmly connected.
- Use the power cord and the AC adapter MODEL8262 supplied with the Product.
- The AC adapter is rated to 100 V AC – 240 V AC. When using MODEL7170 power cord, ensure that it should be connected to 125 V AC or less.
- The AC adapter frequency rating is 50/ 60Hz.
- Always check the frequency rating is not exceeded, and do not connect to a circuit in which 240 V AC or higher electrical potentials exist. Otherwise, it may damage the AC adapter or KEW5050 and electrical accidents may happen.

- Earth cable –

- Use the supplied earth cable and connect the Product to a well-known earth terminal. Never connect the earth cable to a live circuit to avoid damaging the Product and prevent electrical accidents; the cable isn't protected against high voltage.

⚠ WARNING

- Verify proper operation on a well-known source before starting to use the Product.

⚠ CAUTION

- Examine the conductor under test before starting a test. It might be hot.
- Do not apply current or voltage exceeding any measuring ranges for a long period.
- Never apply voltage or current to voltage test leads or clamp sensors while the Product is off.
- Do not use the Product at dusty places or to be spattered.
- Keep away from a strong electric magnetic field or energized object.
- Never give strong vibrations or drop shocks.
- Insert an SD card to the slot with the correct orientation. If the card is inserted up-side-down, the SD card or the Product may be damaged.
- Do not replace or remove SD card while the Product is transferring or accessing information. (The  symbol blinks while accessing the SD card.) Otherwise, the saved data in the card may be lost or the Product may be damaged.

- Clamp sensor -



- Do not bend or pull the cable of the clamp sensor.

- Battery -





- Brand and type of the batteries to be used should be harmonized.

- Treatment after use -

- Power off the Product and disconnect the power cord, voltage test leads and clamp sensors from the Product.
- Remove the batteries if the Product is to be stored and will not be in use for a long period.
- Remove the SD card when carrying the Product.
- Never give strong vibrations or drop shocks when carrying the Product.
- Do not expose the Product to direct sunlight, high temperature, humidity or dew.
- Use a damp cloth with neutral detergent or water for cleaning the Product. Do not use abrasives or solvents.
- Dry and store the Product if it is wet.

Carefully read and follow the instructions:  DANGER,  WARNING,  CAUTION and NOTE described in each section.

Meaning of symbols on the Product:

	User must refer to the explanations in the instruction manual.
	Instrument with double or reinforced insulation
	AC
	Functional earth
	Crossed-out wheel bin symbol (according to WEEE Directive: 2002/96/EC) indicating that this electrical product may not be treated as household waste, but that it must be collected and treated separately.

1. Functional overview

1.1 Features

Description

KEW 5050 is an advanced LEAKAGE CURRENT LOGGER that is able to identify the resistive leakage current I_{or} in various wiring systems. The I_{or} is the dangerous component of the leakage current because I_{or} consumes power and then it can cause a rise in temperature that can lead to fire and electrical shock. KEW 5050 can simultaneously measure and record several parameters such as: I_{or} resistive leakage current, R Insulation Resistance based on I_{or} , I_{om} and I_{o} leakage current with and without harmonic components, V_m and V mains voltage with and without harmonic components, θ phase difference and F mains frequency. KEW 5050 can measure instantaneous and event values.

Wiring configuration

KEW 5050 supports single-phase 2-wire, single-phase 3-wire, three-phase 3-wire, three-phase 4-wire. The graphic display shows how to connect the KEW 5050 to the electrical installation under test according to the wiring configuration set. Vector diagram shown on display helps to check the correct orientation of the clamp sensors.

Less susceptible to harmonics

Measured value is determined on basic waveform of mains frequency by a unique calculation method. Thus, leakage current with harmonics does not affect the measured value.

* Leakage current Trms (I_{om}) and reference voltage Trms (V_m) values contain harmonics.

Measurement at pre-set interval

Easy to find intermittent leakage current since KEW 5050 will measure and record data every 200 ms with gapless. If the selected interval is longer than 200 ms, the max., min., average and instantaneous values in the selected period will be saved at the set interval.

Events detection

In case KEW 5050 detects a value of current / voltage larger (or lower) than the threshold values, it will record the value of detected current / voltage with date and time but also the instantaneous leakage current.

Saving data

KEW 5050 has a logging function with user-selectable recording intervals. The saved data is stored in the SD card offering possible recording time up to several years. The start/stop of the logging can be done by manual or automatic operation. A useful Print Screen function allows the end user to save displayed screens as BMP files.

Vector diagram

Vector diagram of KEW 5050 graphically represents the phase relation between reference voltage (V) and leakage current (I_o) on its display.

Dual power supply system

KEW 5050 operates either with AC power supply or with battery. AA alkaline dry-cell battery (LR6) and AA Ni-MH rechargeable battery can both be used. * Rechargeable battery and specific charger are not supplied. If using rechargeable battery, use the charger which is manufactured by the same company as the battery. For safety reason, KEW 5050 does not charge rechargeable battery.

Data analysis

The saved data can be read by a PC or can be transferred to a PC via USB. Dedicated software "KEW Windows for KEW5050" allows data analysis and the setup of KEW 5050 on a PC.

Signals output

KEW 5050 has digital output signals that can activate alarm devices when events occur. *Alarm devices are not supplied with KEW 5050.

Safety construction

KEW 5050 is designed to meet the International Safety Standard IEC 61010-1 CATIV 300V / CATIII 600V.

1.2 Constructional drawing

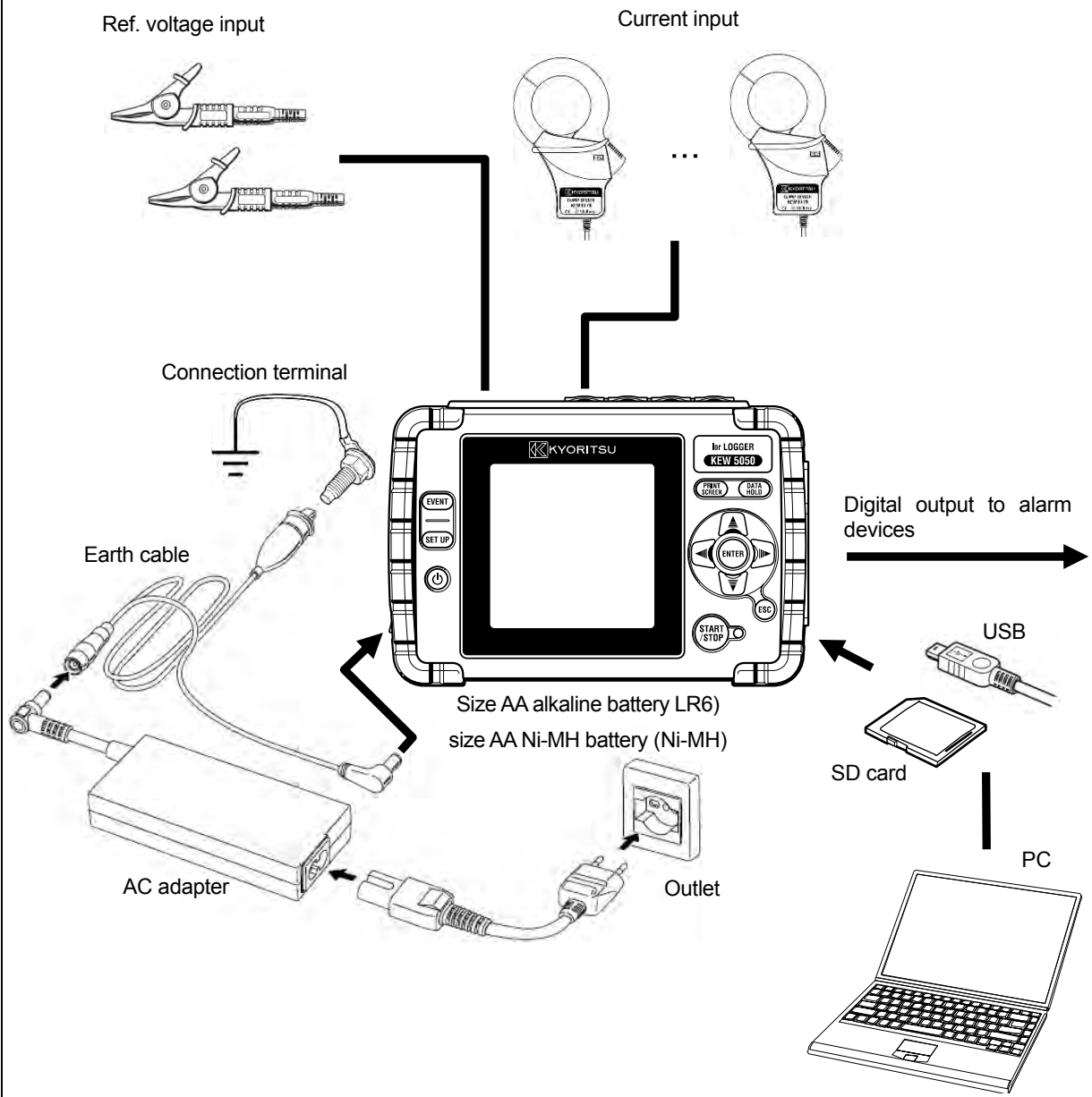

1.3 Steps for measurement

Read through the operating instructions described in "**Safety Warnings**" (P.7) before starting to use the Product.

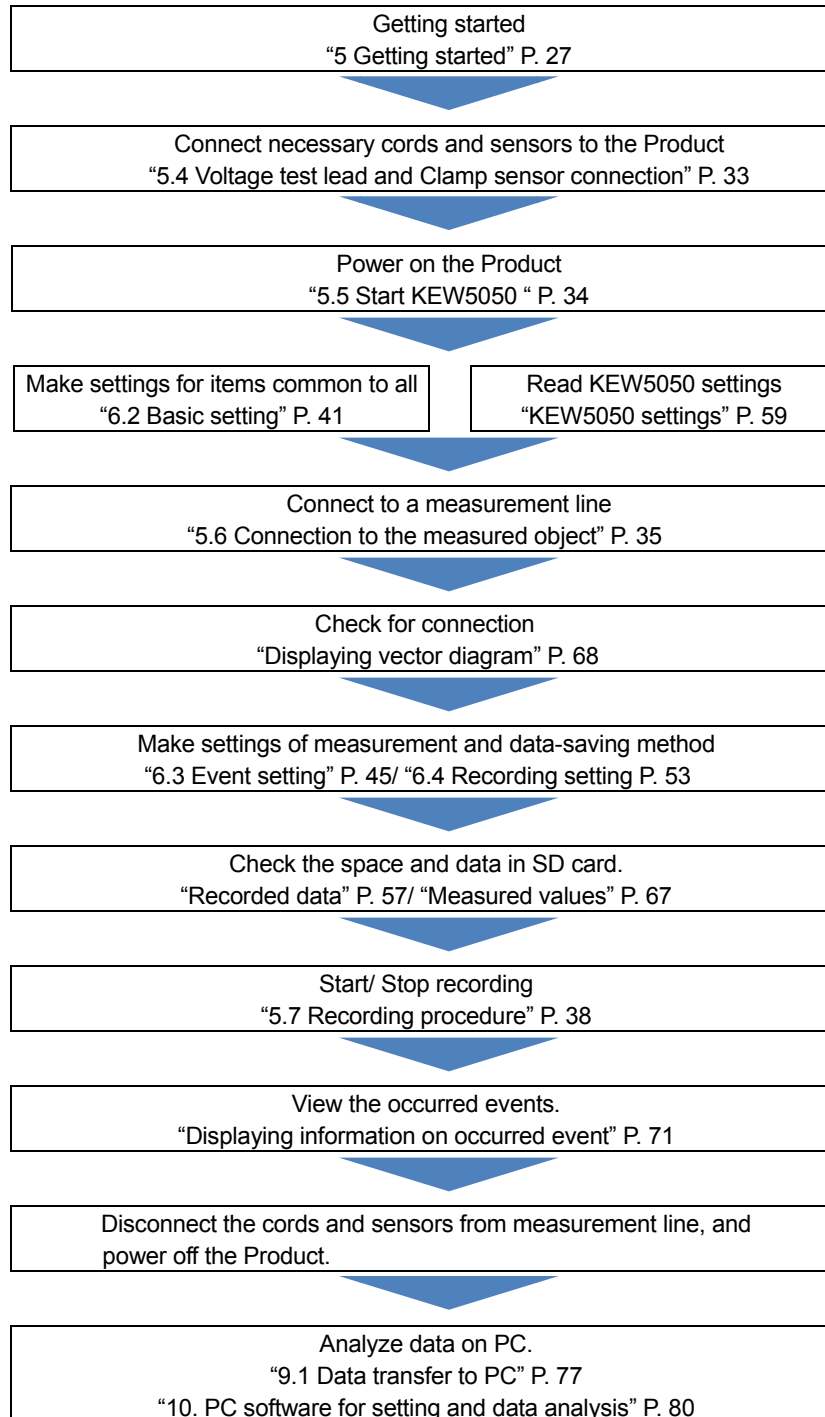

2. Product layout

2.1 Display(LCD)/ Keys

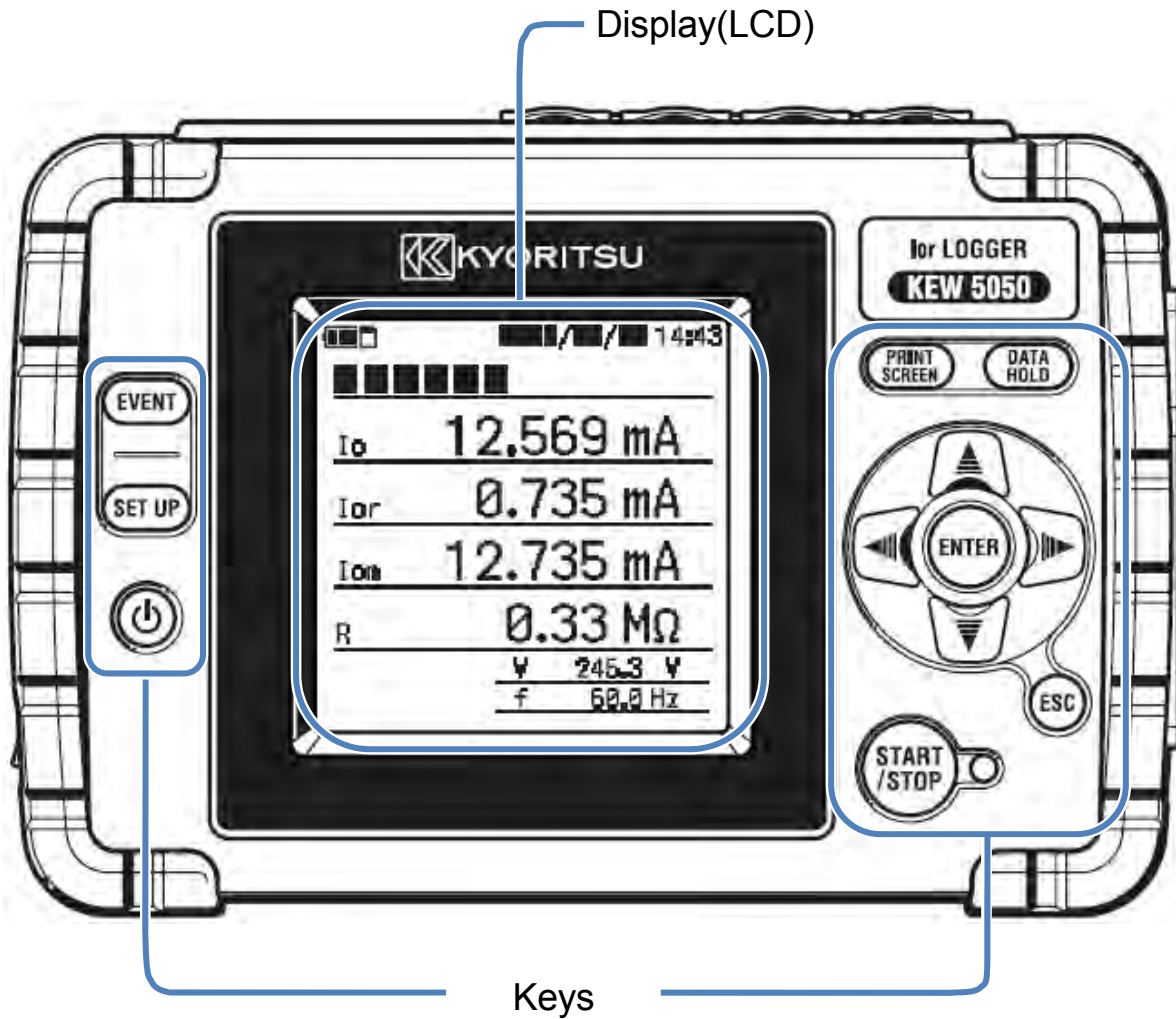

2.2 Connector

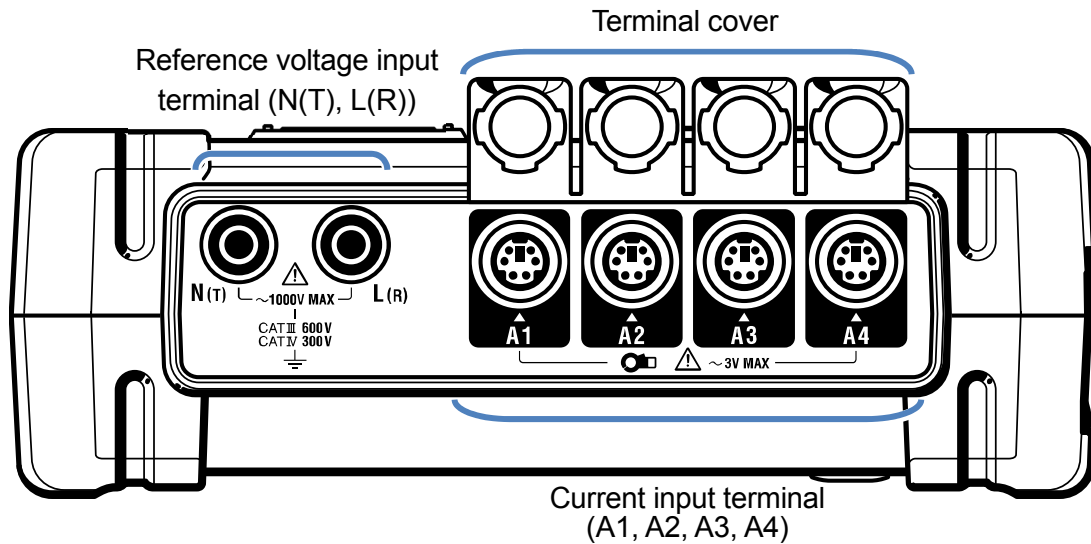

Wiring configuration		Reference voltage input terminal ^{*1}	Current input terminal (×number of systems ^{*2})
Single-phase 2-wire	1P2W	N, L	A1 to A4
Single-phase 3-wire	1P3W	N, L1	A1 to A4
Three-phase 3-wire	3P3W	T, R	A1 to A4
Three-phase 4-wire	3P4W	N, R	A1 to A4
Voltage, Current logging	V, A	N(T), L(R)	A1 to A4

^{*1} Always connect the reference voltage even when measuring current only; otherwise, measurement errors increase and result in inaccurate measurement.

^{*2} When measuring multiple systems simultaneously, connect the clamp sensors required for the intended measurement only in order from A1.

2.3 Side face

< Connector cover closed >

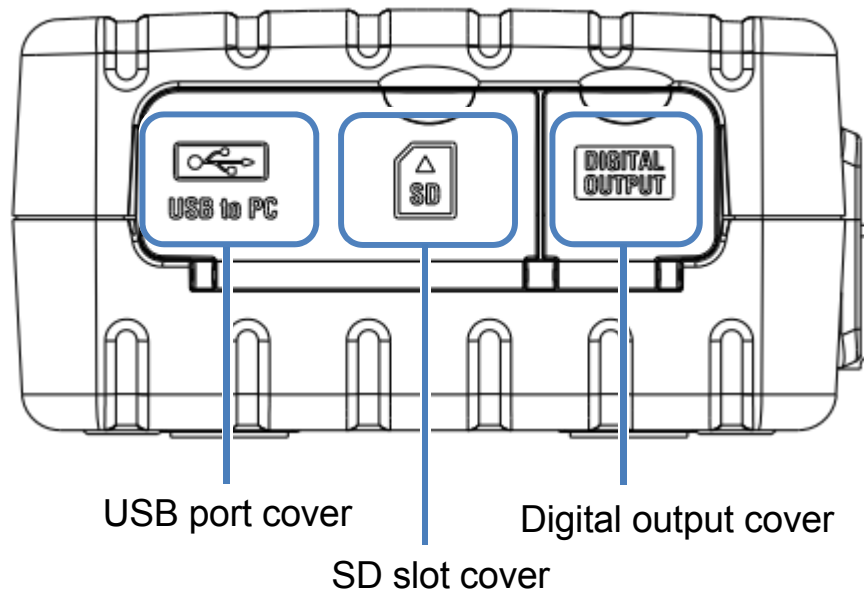

< Connector cover opened >

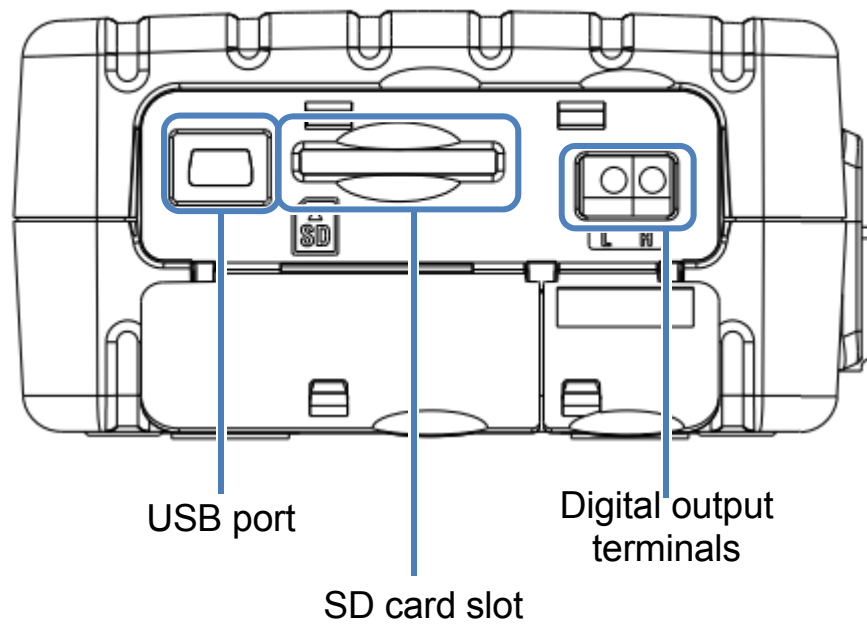

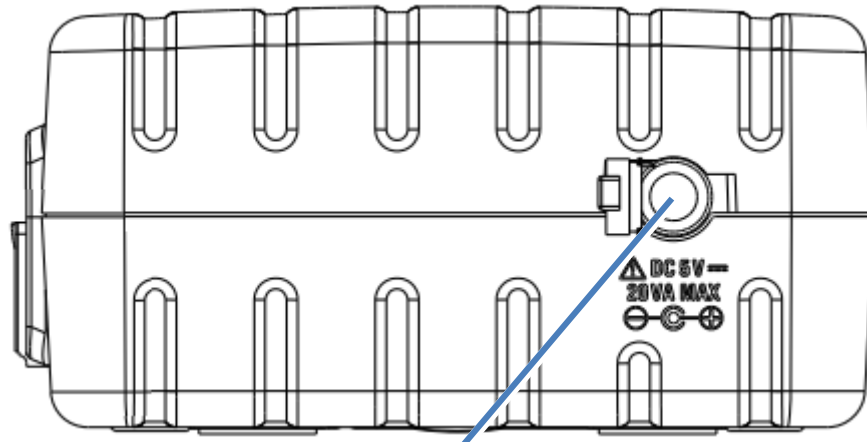

Connector for AC adapter

2.4 Voltage test lead and clamp sensor

<Alligator clip> *Tip of voltage test lead

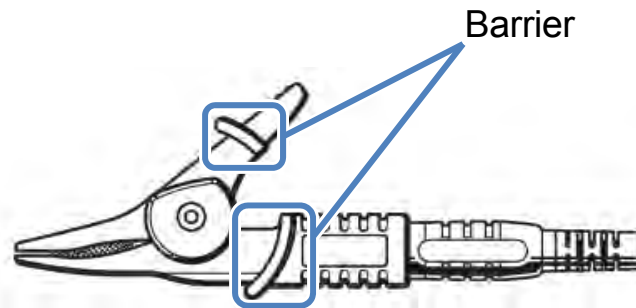

<Clamp sensor>

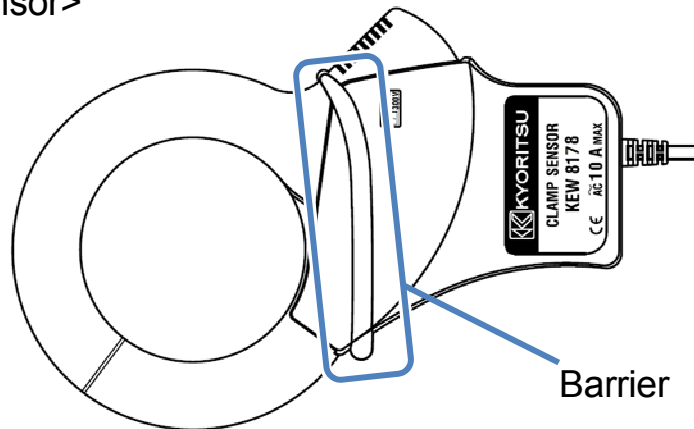

Barrier is a mechanical safety part and provides protection against electrical shock and ensures the minimum required air and creepage distances. Keep your fingers and hands behind the barrier during a measurement.

3. Basic operations



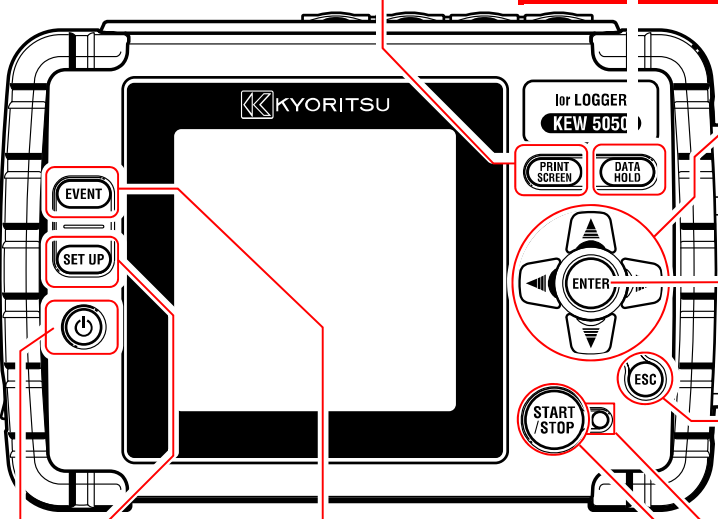









3.1 Keys



The diagram shows the Kew5050 device with the following keys and their functions:

- PRINT SCREEN key:** Save the currently displayed screen as BMP file.
- DATA HOLD key:** Hold the readings on the display. * Measurement continues while the readings are being held on the display. Long press (at least 2 sec.) disables all keys to prevent unintentional operations. Another long press restores the disabled Keys.
- Cursor key:** Select item or switch displays.
- ENTER key:** Confirm the entries.
- ESC key:** Cancel setting changes and return to the previous settings.
- Status LED:**
 - Green: Light up: Recording/ measuring; Blink: Stand-by
 - Red: Blink: Backlight is off.
- START/ STOP key:** Start/ stop measurement.
- EVENT key:** Show the event occurrence status.
- SET UP key:** Change and confirm the settings for wiring, basic items, measurement and recording, and edit the saved data.
- POWER key:** Power on/ off the Product.

3.2 Icons on LCD

Icons	Description
	The Product is operating with battery. This icon varies in 4 steps according to the battery power condition.
	The Product is operating with AC power supply.
	Display is held.
	Keys are locked.
	SD card is accessible.
	Recording data in the SD card.
	Not enough storage space in the SD card.
	Failed to access the SD card.
	Stand-by state
	Recording the measured values.
	The SD card is full.
	USB is available.

3.3 Symbols on LCD

Symbols displayed on the LCD					
I_{om}	Leakage current (Trms) including harmonic components	I_o	Leakage current (Trms) with basic wave of 50/ 60Hz only	I_{or}	Leakage current (Trms) with resistive components only
V_m	Reference voltage (Trms) including harmonic components	V	Reference voltage (Trms) with basic wave of 50/ 60Hz only	f	Frequency of reference voltage
θ	Phase angle - lagging + leading	Indicates phase angle of leakage current Trms (I_o), basic wave by regarding phase angle of reference voltage Trms (V), basic wave, as 0.0° .			
R	Insulation resistance (Ref. value)	Shows insulation resistance values determined by the following formula. V : Reference voltage/ I_{or} : Leakage current (Trms, basic wave) (Trms, resistive components) Note: Displayed value is just for reference since the measurement method differs from insulation resistance testers and may not be consistent with each other.			

A number representing CH number is added and displayed with above symbol. If just the symbol is displayed, without a number, it means that the value is the sum of all CHs.

3.4 Screens

Rough chart of available screens

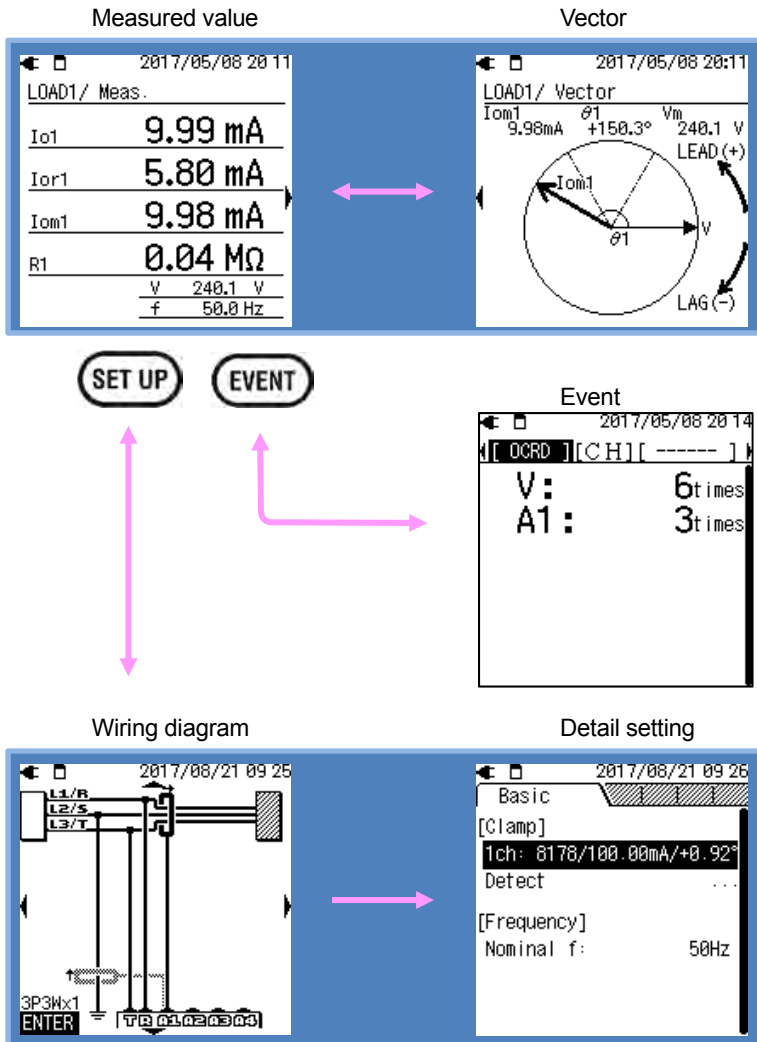

Measured value (vector)

* Taking single-phase 2-wire as an example.

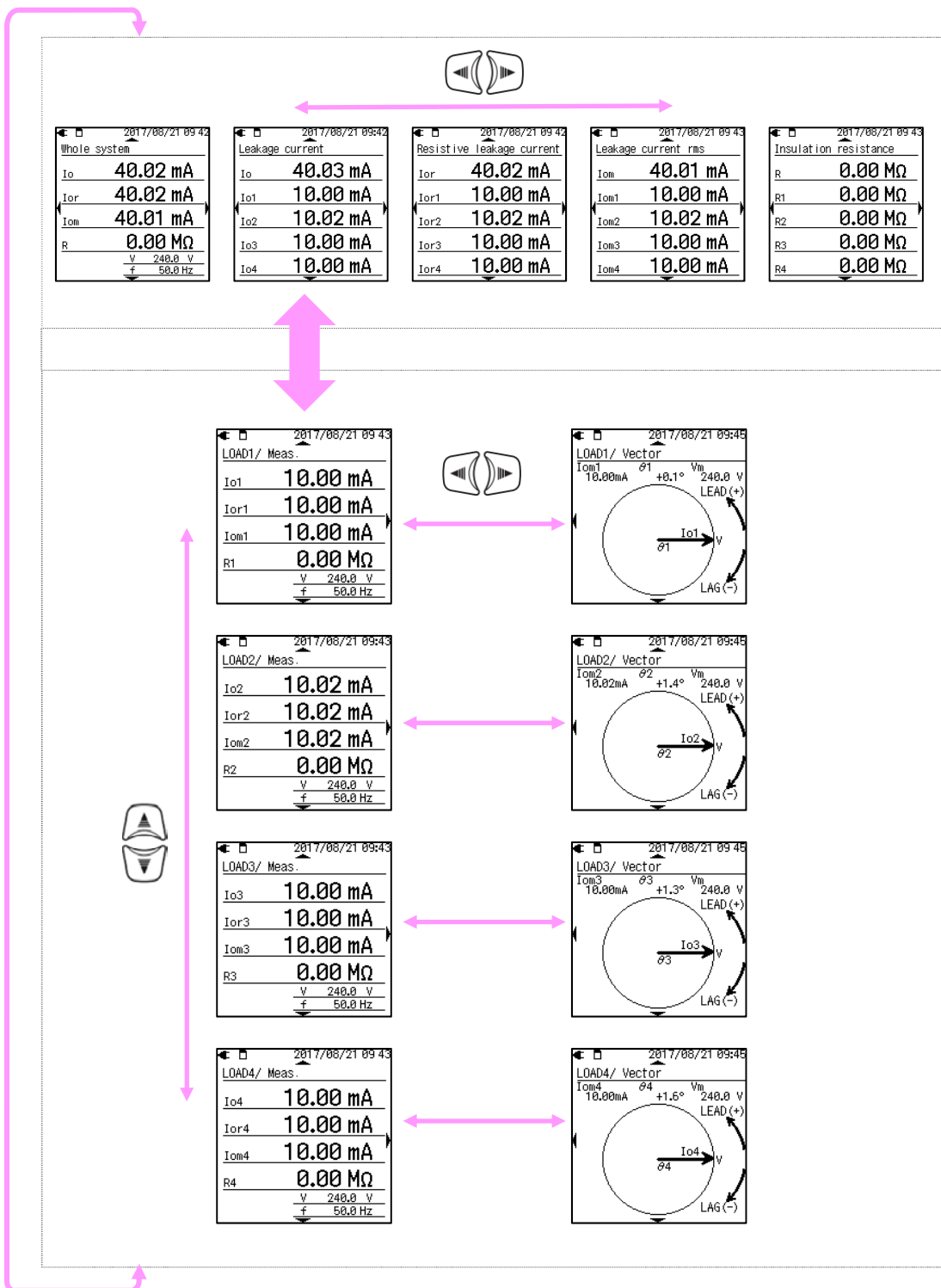

Event

EVENT : Switches displayed items.

+ **ENTER** : Moves black highlight to the items enclosed in “<” “>” marks.

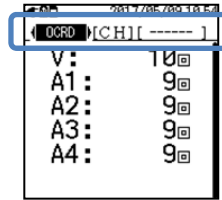

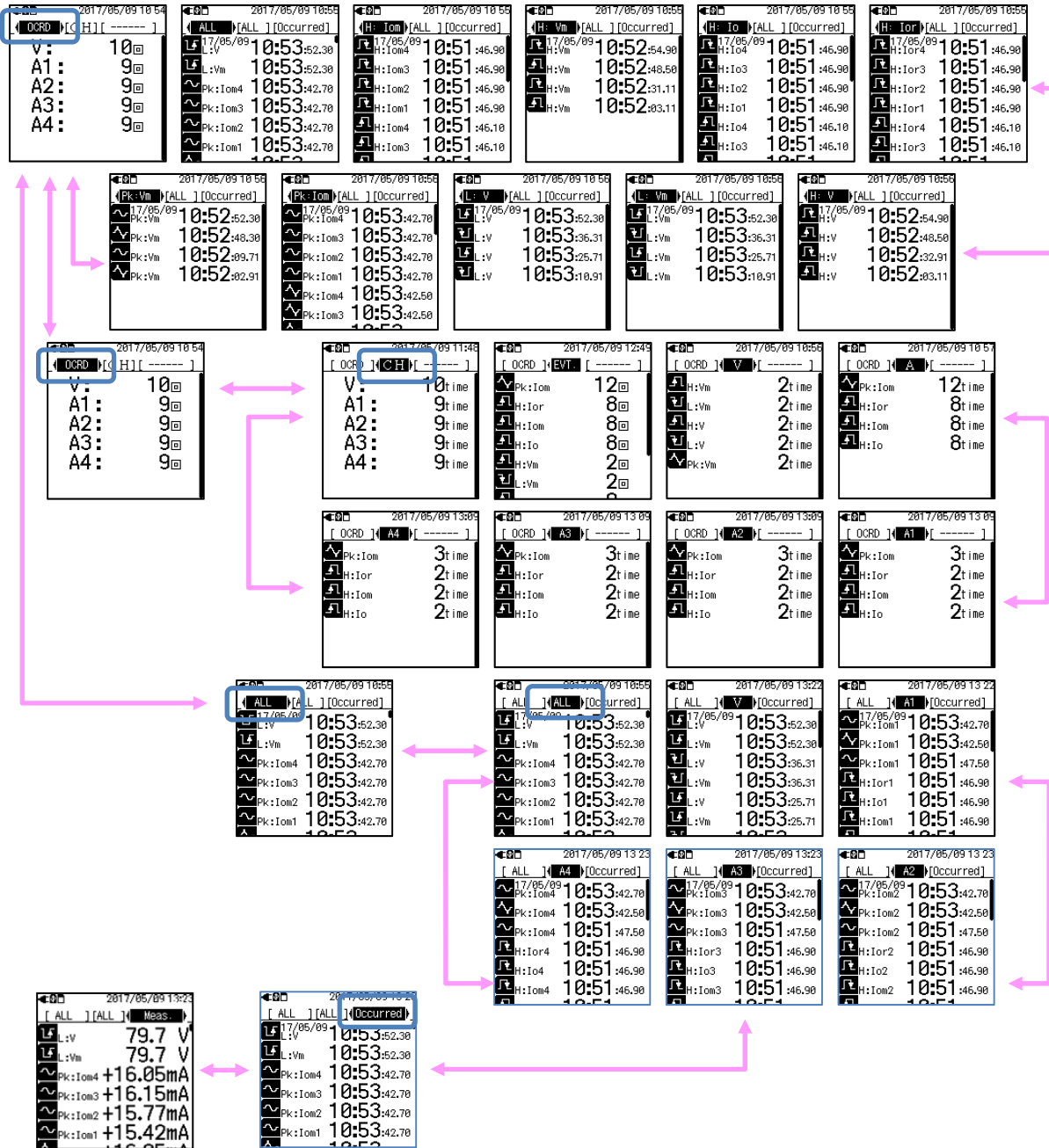

* The following examples show the status that all events are detected on four systems (A1 to A4)

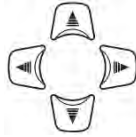
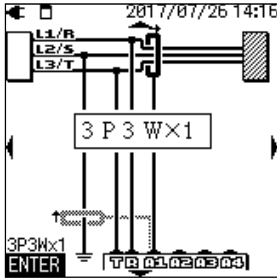

Settings

SET UP : Switches the displayed items.



Press  to toggle the screens.

2017/08/21 14:17

Basic

[Cramp]

1ch: 8178/100.00mA/+0.92%

Detect

[Frequency]

Nominal f: 50Hz

2017/08/21 14:17

Event

[Common]

Hysteresis: 5%

[Upper TH(H)]

H:Iom ON

H:Vm ON

H:Io ON

H:Ior ON

2017/08/21 14:17

Recording

[REC method]

Interval: 30min.

Start: Manual

2017/08/21 14:17

Saved data

[REC data]

Check free memory space...

Delete data...

Format

[KEW5050 setting]

Save settings...

Read settings...

2017/08/21 14:17

Others

[Environment]

Language: English

Date format: YYYY/MM/DD

[KEW5050 setting]

Time: 2017/08/21 14:17

ID Number: 00-001

Buzzer: OFF

4. Leakage current

In general, insulation monitoring devices measure leakage current (**I_o**) and detect deterioration of insulation; however, the measured leakage current usually includes resistive leakage current (**I_{or}**) – potential causes of fire, electrical shock or power loss - and capacitive leakage current (**I_{oc}**) – usually not dangerous. Therefore, to diagnose insulation deterioration accurately on an electrical installation with large I_{oc} (e.g. installation with long wiring or with inverter devices) is difficult.

Example:
I_o on single-phase 2-wire
 Vector: $I_o = I_{or} + I_{oc}$

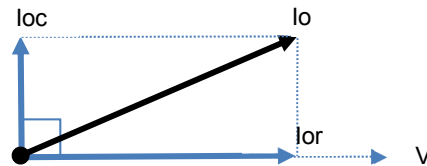

I_{or} and voltage (**V**) flow in the same phase (no phase difference) and they can be converted to active power as follows.

$$\text{Active power (P)} = V \times I_{or} \times \cos 0^\circ (\cos 0^\circ = 1) = \underline{V \times I_{or}}$$

It means that I_{or} consumes power and then it can cause a rise in temperature that can lead to fire and electrical shock.

<Why I_{oc} is not usually dangerous?>

On the other hand, **I_{oc}** leads the phase to voltage by 90° and can be converted to active power as follows.

$$\text{Active power (P)} = V \times I_{oc} \times \cos 90^\circ (\cos 90^\circ = 0) = \underline{0}$$

The consumed Power of **I_{oc}** will be zero and then it can be ignored as no dangerous situations usually occur.

4.1 Leakage current (I_o) measurement

To determine **I_o**, harmonics are removed from the basic wave of leakage current (1st order of nominal power frequency 50/ 60 Hz) using Fast Fourier transform (FFT).

$$I_o = \sqrt{I_{o_kr}^2 + I_{o_ki}^2}$$

Where:

I_{o_kr}: real number component after FFT,

I_{o_ki}: imaginary number component after FFT, and

k = 1: FFT analysis order (1st order)

4.2 Resistive leakage current (*I_{or}*) measurement

Single-phase 2-wire

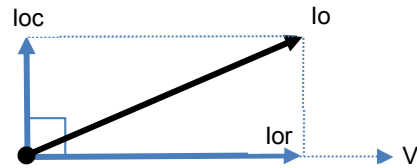
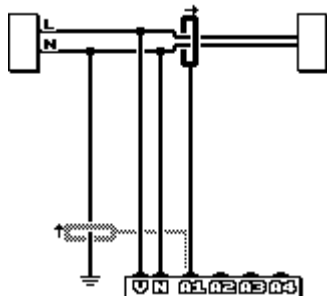

To find ***I_{or}*** only, we determine active power (***P***) using ***I_o*** and real and imaginary numbers of Trms reference voltage (***V***) at first, and then remove ***V***.

$$P_k = V_{kr} \times I_{o_kr} + V_{ki} \times I_{o_ki}$$

$$V = \sqrt{I_{o_kr}^2 + I_{o_ki}^2}$$

$$I_{or} = \frac{P_k}{V}$$

Where:

_kr: real number component after FFT, ***_ki***: imaginary number component after FFT, and ***k*** = 1: FFT analysis order (1st order)

Single-phase 3-wire

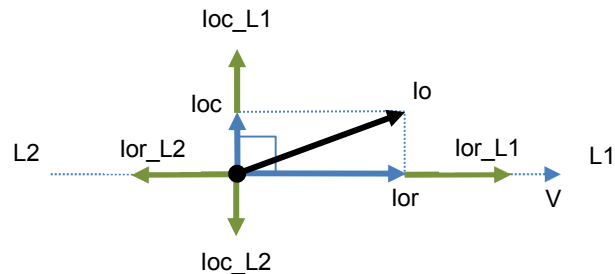
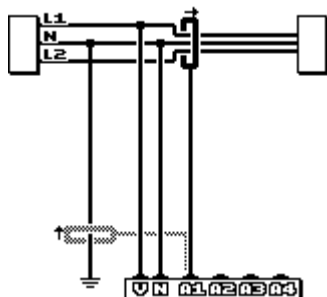

Where:

I_{or_L1} and ***I_{or_L2}*** represent resistive leakage current in L1 and L2 phase, and ***I_{oc_L1}*** and ***I_{oc_L2}*** represent capacitive leakage current in L1 and L2 phase respectively.

Theoretically if insulation deterioration occurs in L1 and L2 phase simultaneously and in the same value, ***I_{or}*** is canceled because the voltage across L1 and L2 is always in opposite phase. But practically this is a very rare case; therefore, it is possible to test and judge the phase with relevant degraded insulation. The vector direction of ***I_o*** helps to identify the phase with relevant degraded insulation. To find ***I_{or}*** only, we determine active power (***P***) using ***I_o*** and real and imaginary numbers of Trms reference voltage (***V***) at first, and then remove ***V***.

$$P_k = V_{kr} \times I_{o_kr} + V_{ki} \times I_{o_ki}$$

$$V = \sqrt{I_{o_kr}^2 + I_{o_ki}^2}$$

$$I_{or} = \frac{P_k}{V}$$

Where:

_kr: real number component after FFT, ***_ki***: imaginary number component after FFT, and ***k*** = 1: FFT analysis order (1st order)

Three-phase 3-wire

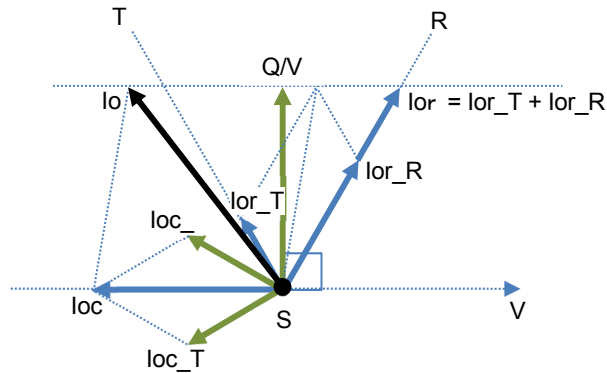
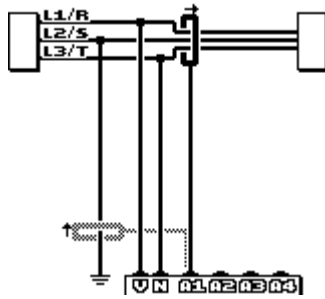

In the above illustration, I_{or_R} and I_{or_T} represent resistive leakage current in R and T phase, and I_{loc_R} and I_{loc_T} represent capacitive leakage current in R and T phase respectively.

First, find reactive power Q using I_0 and real and imaginary numbers of Trms reference voltage (V), and then remove V to find a reference value. I_{or} flows in the same phase as voltages flow in R and T phases. When I_{loc_R} and I_{loc_T} are balanced, I_{loc} flows in the reverse direction against V . The above figure shows relationship of each component in the form of vector. Use the following formula to find I_{or} .

$$Q_k = V_{kr} \times I_{0_ki} + V_{ki} \times I_{0_kr}$$

$$V = \sqrt{I_{0_kr}^2 + I_{0_ki}^2}$$

$$I_{or} = \frac{2\sqrt{3}}{3} \times \frac{Q_k}{V}$$

Where:

$_kr$: real number component after FFT, $_ki$: imaginary number component after FFT, and $k = 1$: FFT analysis order (1st order)

The vector direction of I_0 helps to identify the phase with relevant degraded insulation.

Note: When a vector of I_0 is between the vectors of I_{loc_R} and I_{loc_T} , the relationship of current magnitude will be $I_{or} = I_0 \cdot (Q/V)$. If I_{loc_R} and I_{loc_T} are unbalanced, measurement error occurs.

Three-phase 4-wire

In the following illustration, I_{or_R} , I_{or_S} and I_{or_T} represent resistive leakage current in R, S and T phase, and I_{loc_R} , I_{loc_S} and I_{loc_T} represent capacitive leakage current in R, S and T phase respectively.

When I_{loc} in each phase are balanced, the total leakage current will be zero and can be ignored. In this case, I_0 and I_{or} are equal.

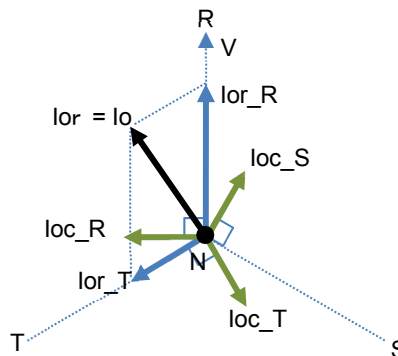
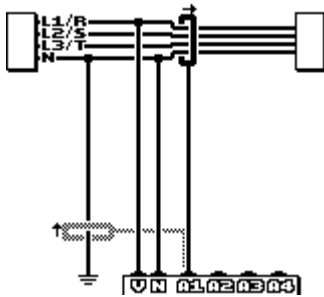

The vector direction of I_0 helps to identify the phase with relevant degraded insulation.

lor measurement on wiring with different capacities

Phases of **lor** and **loc** may overlap when testing Delta, Open Delta/ V-connection three-phase systems with different capacities. In such cases, removing **loc** from **lo** is impossible; therefore, **lor** cannot be accurately measured. Leakage current doesn't flow on the flowing power supply (not connected to earth ground) such as IT system; so also in this case **lor** cannot be measured.

5. Getting started

5.1 Attaching markers to clamp sensors

Attach the color markers to clamp sensors for easy recognition. Colors of the marker are harmonized with that of current input terminals (red: A1, yellow: A2, blue: A3, green: A4). Supplied markers are 8 pcs in total (red, blue, yellow, green: 2 pcs each).

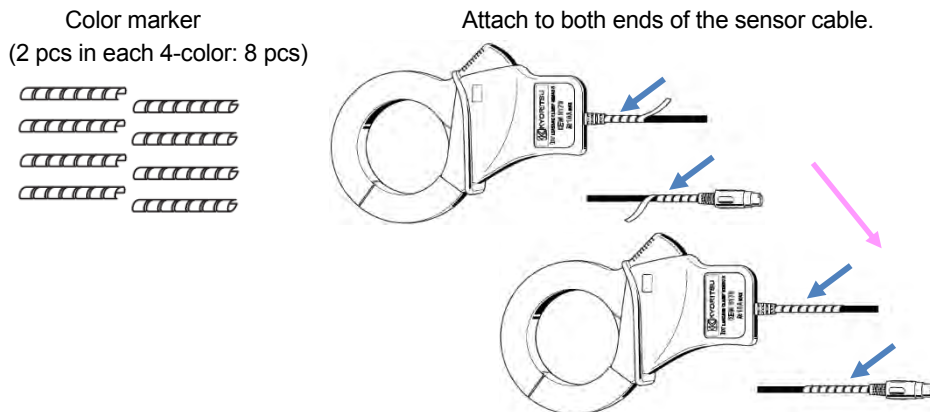

5.2 Power supply

The Product operates with either AC power supply or battery. Capable of performing measurements in the event of AC power interruption, power to the Product is automatically restored by the batteries installed in the Product.

Battery

AA alkaline dry-cell battery (LR6) or AA Ni-MH battery can both be used. To charge rechargeable battery, use the charger which is manufactured by the same company as the battery. The Product cannot charge batteries.

* Size AA alkaline dry-cell batteries (LR6) are supplied as accessories.

⚠ DANGER

- Do not try to replace batteries during a measurement.
- Never touch the connector of AC adapter while the Product is operating with batteries.

⚠ WARNING

- Ensure that the power cord, voltage test leads and clamp sensors are removed from the Product, and that the Product is switched off when opening the battery compartment cover for battery replacement.

CAUTION

- Brand and type of the batteries to be used should be harmonized.
- Never mix new and old batteries.
- Install batteries in correct polarity as marked inside the battery compartment area.

Note

Batteries are not installed in the Product at the time of purchase. Please insert the supplied batteries before starting to use the Product. Battery power is consumed even if the Product is being off. Remove all the batteries if the Product is to be stored and will not be in use for a long period.

How to install batteries

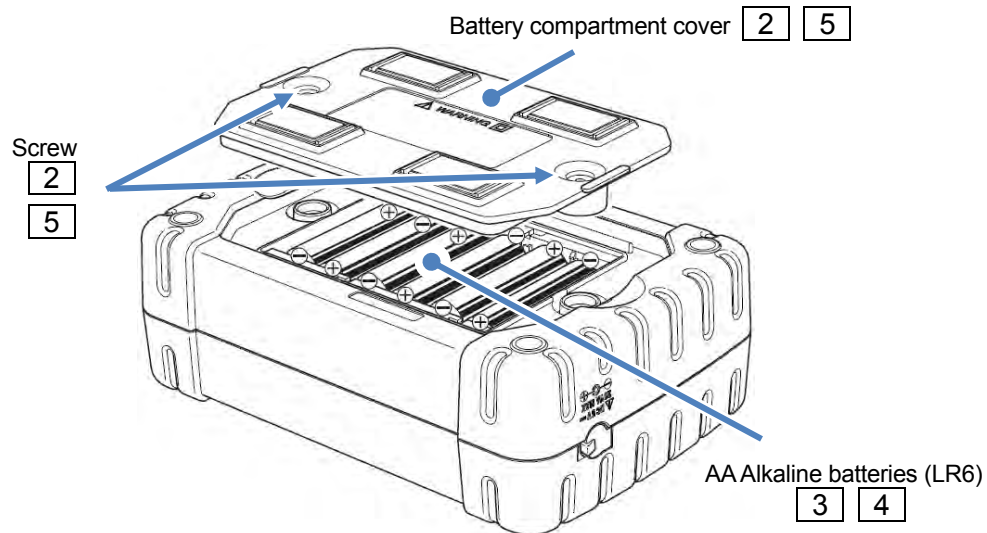

- 1 Disconnect AC adapter, earth cable, voltage test leads and clamp sensors from the Product, and power off the Product.
- 2 Loosen two battery compartment cover-fixing screws and remove the cover.
- 3 Take out all the batteries.
- 4 Insert six batteries (size AA alkaline battery: LR6) in correct polarity.
- 5 Install the battery compartment cover and fix it with two screws.

The battery indicator/ AC power icon

The battery indicator icon varies according to the battery condition; the icon changes to AC power icon when the Product is connected to AC power.

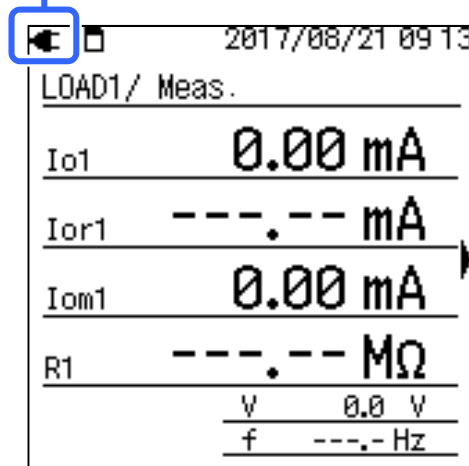
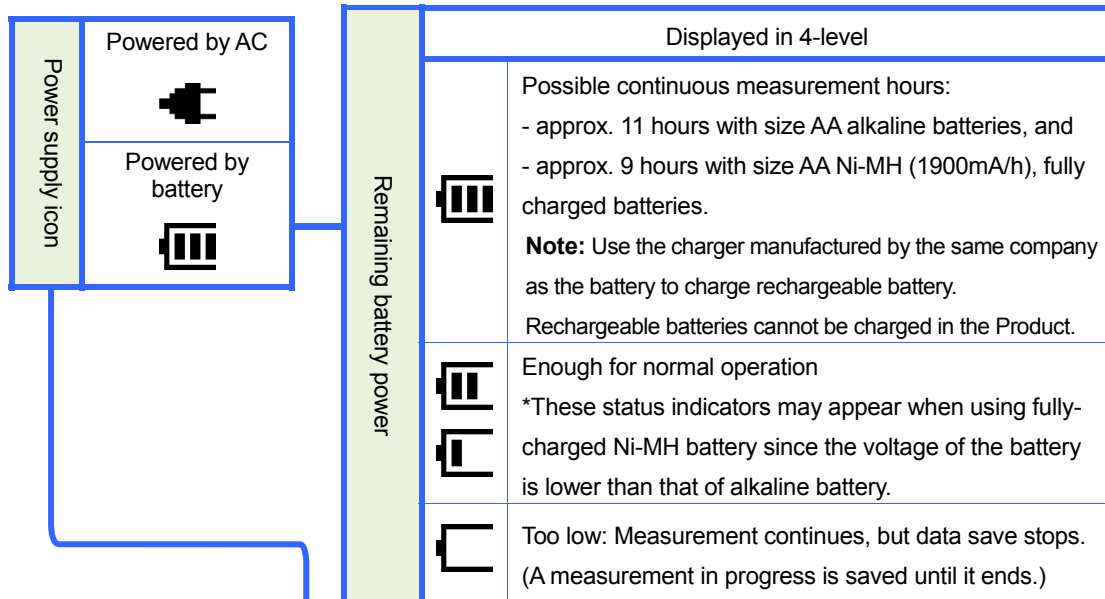

AC adapter

For a long period of logging, use the supplied AC adapter. It is recommended to install batteries even while connecting the Product to mains outlet. Power to the Product is automatically restored by the installed batteries in the event of unexpected power interruption. The following tables show the ratings of AC adapter and power cord.

MODEL7170 Power cord

Rated supply voltage	125 V AC
Rated supply current	7 A max

MODEL8262 AC adapter

Rated supply voltage	100 – 240 V AC ($\pm 10\%$)
Rated supply freq.	50/ 60Hz
Max power consumption	20 VA max.

 Always check the followings before plugging/unplugging the AC adapter.

DANGER

- Use only the AC adapter and the power cord supplied with this Product.
- Never connect MODEL7170 power cord to a power supply of greater than 125 V AC.
- Ensure that the rating suits the power supply voltage and the frequency to be used. Do not connect the AC adapter to a power supply greater than 240 V AC (50/ 60Hz) otherwise it may damage the adapter or the Product and cause electrical accident.
- **Connect the supplied earth cable to a well-known earth terminal to earth the Product.** Never connect the earth cable to a live wire to avoid damaging the Product or to prevent electrical accident since the cable is not protected against high voltage.

WARNING

- Power off the Product and connect the power cord.
- Connect the power cord to the Product first, and then to an outlet. The cord should be firmly connected.
- Never attempt to make measurement if any abnormal conditions are noted, such as cracks or exposed metal parts.
- Disconnect the power cord from the outlet when the Product is not in use.
- When unplugging the power cord from the outlet, do so by removing the plug first and not by pulling the cord.

Note

- **Always connect the supplied earth cable when using the AC adapter and make measurements to stabilize the readings.**
- Use of AC adapter to supply power to the Product can conserve battery life.
- The Product shuts off in the event of sudden power interruption and data may be lost if no batteries are installed in the Product.

AC adapter connection

Follow the procedure below and connect the AC adapter to the Product.

- 1 Confirm that the Product is powered off.
 - 2 Firmly connect the power cord to the AC adapter.
 - 3 Connect the output terminal of the AC adapter to the female connector of the earth cable.
 - 4 Firmly connect the connection terminal of earth cable to the AC adapter connector on the Product.
- * Direct connection of AC adapter to the Product – insert the output terminal of AC adapter to the connector for AC adapter on the Product – is allowed where the Product is connected to a PC for data analysis and performs no measurements.

- 5 Connect the clip of the earth cable to **a well-known earth terminal.**

⚠ DANGER: Always check and confirm the terminal to be connected is surely the earth terminal.

- 6 Connect the power cord to an outlet.

Never connect to a live conductor.

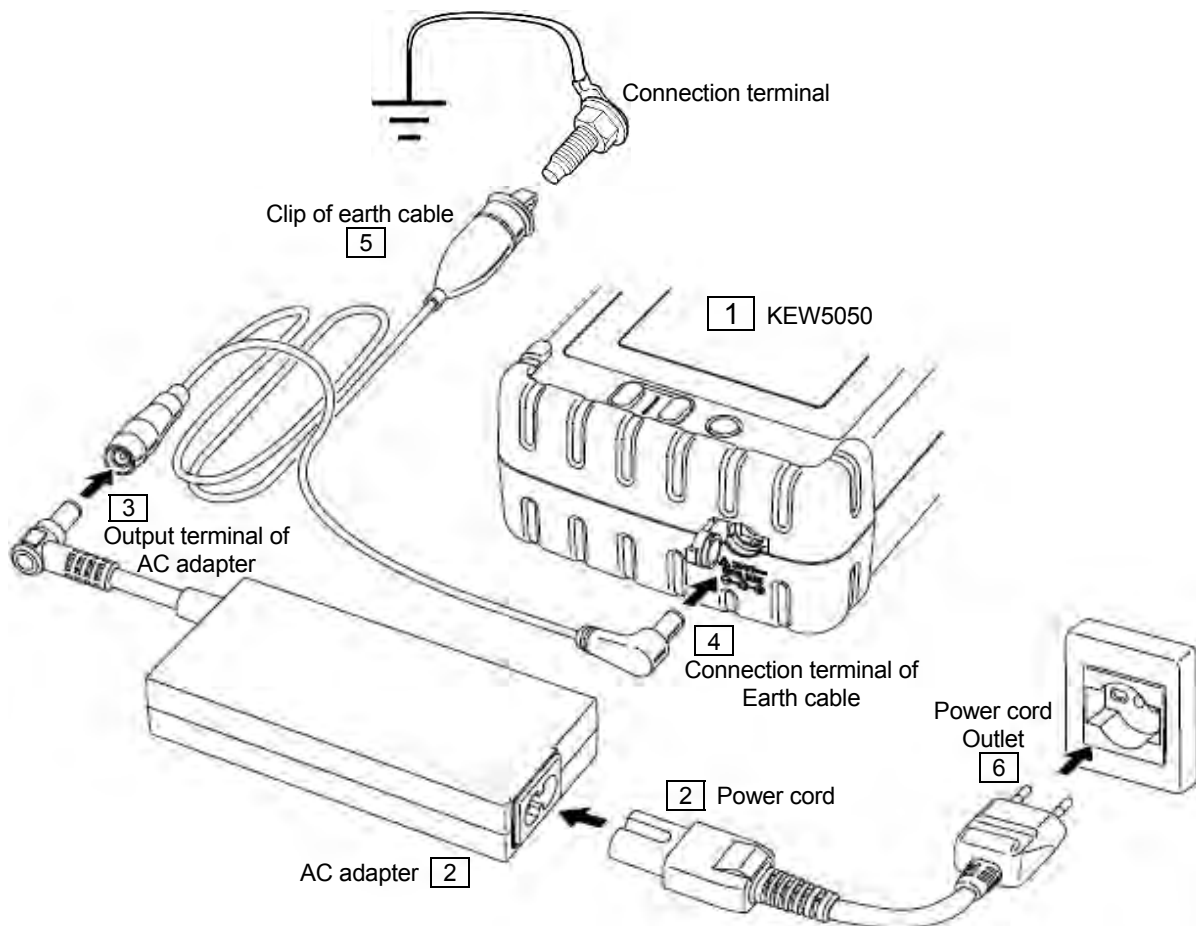

The Product can derive power from a measurement line of 240 V or less to ground by using an optional power adapter, MODEL8329. For further detail, see "9.3 Getting power from measured line" (P. 78).

5.3 Placing/ removing SD card

! Check the following points before using SD card.

⚠ CAUTION

- Follow the instructions described below and insert the SD card into the slot with the correct orientation. Inserting the card with incorrect orientation may damage the card itself or the Product.
- Do not replace or remove the SD card while accessing to the card; otherwise, the saved data in the card may be lost or the Product may be damaged. The  symbol blinks while accessing to the card.
- Do not remove the SD card while **REC** symbol is blinking, otherwise the saved data or the Product may be damaged. Before removing the card, stop recording and confirm that the LCD shows "Recording stopped."

Note

- Use the SD card supplied with the Product or the one supplied as optional parts.
- Newly purchased SD card must be formatted on the Product before use. Data might not be successfully saved on an SD card formatted on a PC. For the details, please refer to "Format" (P.58) in this manual.
- If the SD card has been frequently used for a long period, the flash memory may be exhausted and further data may not be saved on it. In such a case, please use another new card.
- The data in the SD card might be damaged or lost by accident or failure. It is recommended to back up the recorded data periodically. Kyoritsu will not be liable for any loss of data or any other damages or losses.

Inserting SD card

- 1 Open the connector cover.
- 2 Insert the SD card into the SD card slot with the topside turned up.
- 3 Close the cover. Do not leave the cover open unless it is necessary to do so.

Removing SD card

- 1 Open the connector cover.
- 2 Gently push the SD card towards inside, and then the card comes out.
- 3 Remove the card slowly.
- 4 Close the cover. Do not leave the cover open unless it is necessary to do so.

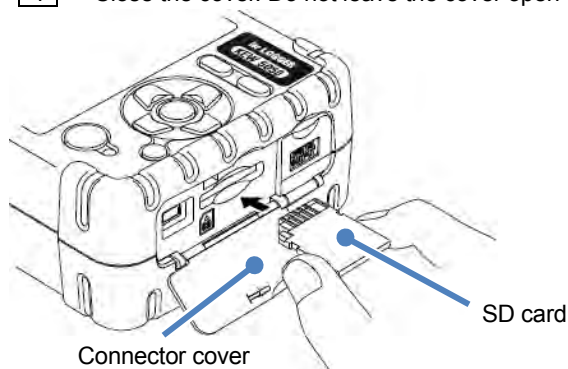

5.4 Voltage test lead and Clamp sensor connection

! Check the following before connecting the test leads and sensors.

⚠ DANGER

- Use only the voltage test leads supplied with the Product.
- Use the clamp sensors designed for the Product. Ensure that the rating of the sensors suits the measurement current.
- Connect the clamp sensors only required for a measurement.
- Connect the test leads and sensors to the Product first, and only then connect them to the circuit under test.
- Never disconnect the test leads and sensors during a measurement - while the Product is supplied from the measurement line.

⚠ WARNING

- Confirm that the Product is powered off, and then connect voltage test leads and clamp sensors.
- Connect the test leads and sensors firmly to the Product first and then to the object to be tested.
- Never attempt to make measurement if any abnormal conditions are noted, such as cracks or exposed metal parts.

Follow the procedure below, and connect the voltage test leads and clamp sensors.

- 1 Confirm that the Product is powered off.
- 2 Connect a voltage test lead to the reference voltage input terminal on the Product.
- 3 Connect the necessary clamp sensors to the current input terminal on the Product. Match the direction of the arrow mark on the output terminal of the clamp sensor and the mark on the current input terminal on the Product.

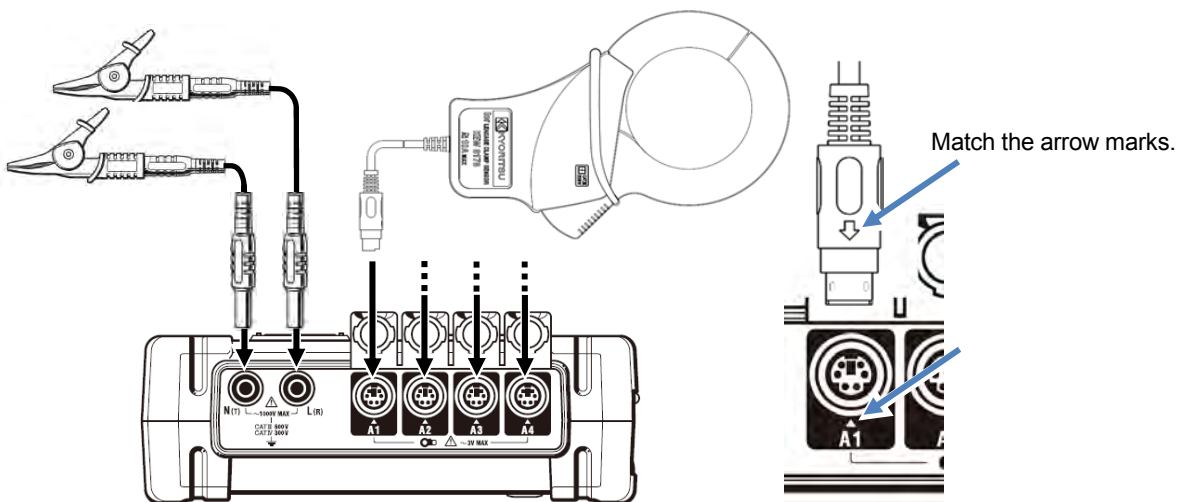







Number of clamp sensors to be used varies depending on the wiring configuration under test. See "Wiring diagrams" (P.37) in this manual.

5.5 Start KEW5050

Start-up screen

Note:

The  key doesn't turn off the Product while  symbol stays on the LCD; key lock function is enabled. Hold down  key at least 2 sec. and confirm  symbol disappears, and then hold down  key 2 sec. or longer to turn off the Product.

Hold down  key until the following screen is displayed. To power off the Product, hold down  key at least 2 sec.

- 1 Model name and software version will be displayed upon powering on the Product. Stop using the Product if it does not get started properly, and refer to "11. Troubleshooting" (P. 89) in this manual.

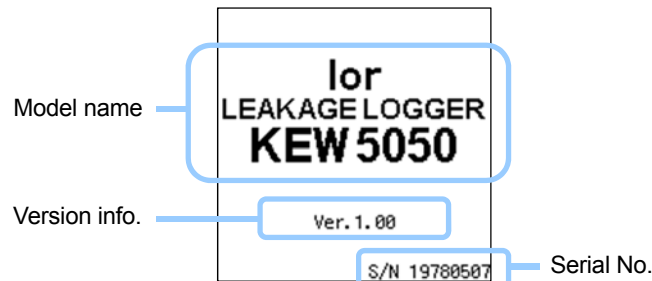

- 2 A screen to show measured values appears followed by the start-up screen.

Cautionary message

If the connected clamp sensors are not the same ones used at the previous test, the LCD shows the sensors currently connected, serial no. and phase correction values five sec. Correct the displayed information if it doesn't conform to the present connection. Press  to move to "Basic setting".

Note:

When using general purpose leakage clamp sensor or load current clamp sensor, manual configuration is required. Press  to move to "Basic setting".

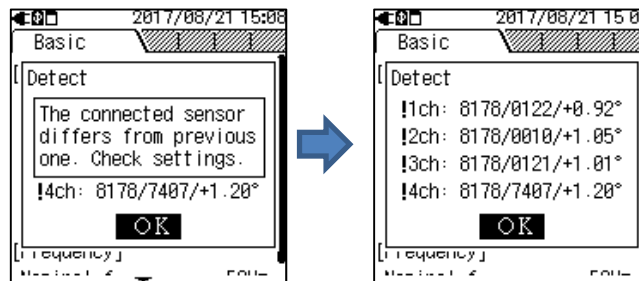

5.6 Connection to the measured object

 Read the following precautions prior to making connection.



DANGER

- The voltage to ground rating of the Product is 300 V AC for CAT IV and 600 V AC for CAT III max. Do not make measurements on a circuit in which the higher electrical potentials exist.
- Use the voltage test leads and clamp sensors designed specially for the Product.
- The voltage to ground rating of the supplied clamp sensors is 300 V AC for CAT III max. The rating differs from the one of reference voltage input terminal on the Product. Always check and confirm that the rating suits the measurement voltage.
- Connect the clamp sensors, voltage test leads and power cord to the Product first, and then connect to the object to be measured or the power source.
- When the Product and the test lead are combined and used together, whichever lower category either of them belongs to will be applied. Confirm that the voltage rating of the test lead is not exceeded.
- Do not connect unnecessary voltage test leads or clamp sensors to the Product.
- Clamp sensors should always be connected on the downstream side of a circuit breaker, which is safer than the upstream side.
- Do not open-circuit the secondary side of a supplementary CT while it is energized; otherwise, high voltage will be generated at the secondary side terminal.
- Be careful to avoid short-circuiting the power line with the un-insulated part of the voltage test leads. Do not touch the tip metal part.
- Transformer jaw tips are designed in such a way to avoid short-circuiting; however, extra care should be taken to minimize the possibility of shorting when measuring un-insulated conductors.
- Keep your fingers behind the barrier during a measurement.
 - * Barrier provides protection against electrical shock and ensures the minimum required air and creepage distances.
- Never disconnect test leads or sensors from the connectors on the Product during a measurement (while the Product is energized).
- Do not touch two lines under test with the metal tips when opening the jaws.

WARNING

- To avoid possible electric shock and short-circuit, always turn off the measurement line under test at connection.
- Do not touch the un-insulated tip of voltage test leads.

Connection method (Selecting wiring system: Wiring diagram)

Press **SET UP** to show the wiring diagram corresponding to the current settings. Use  to toggle the types of wiring system and  to change the number of system. Connect the necessary clamp sensors and voltage test leads according to the displayed wiring diagram, and then press **ENTER** to move to “Basic setting” screen to reflect the selection. The selection won't be reflected by pressing **ESC**.

Note:

- **Always connect voltage test leads** even when measuring current only to calculate the measured values at proper timing and stabilize the readings.
- Phases of **lor** and **loc** may overlap when testing Delta, Open Delta/ V-connection three-phase systems with different capacities. In such cases, removing **loc** from **lo** is impossible; therefore, **lor** cannot be accurately measured. Leakage current doesn't flow on the flowing power supply (not connected to earth ground) such as IT system; so also in this case **lor** cannot be measured.

 For accurate measurement

- Confirm that the configuration of wiring system suits the measurement line.
- Ensure that the arrow mark on the clamp sensor points towards load side (towards neutral at earth line measurement).

When measuring earth line/ A (Load current) X 1 - 4

Neutral/ Load

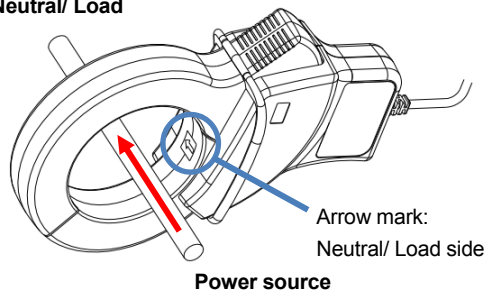

1P2W (Single-phase 2-wire) X 1 - 4

: clamp onto L and N lines

Load

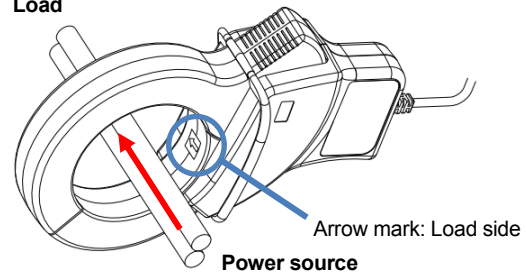

1P3W (Single-phase 3-wire) X 1 - 4: clamp onto L1, L2 and N

3P4W (Three-phase 4-wire) X 1 - 4:

3P3W (Three-phase 3-wire) X 1 - 4 : clamp onto R, S and T

clamp onto L1, L2, L3 and N

Load

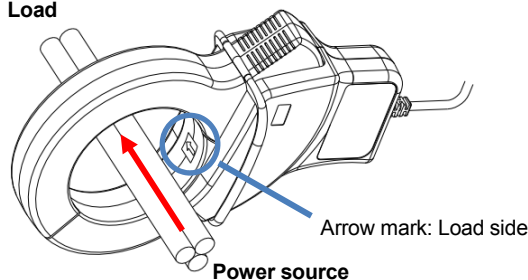

Load

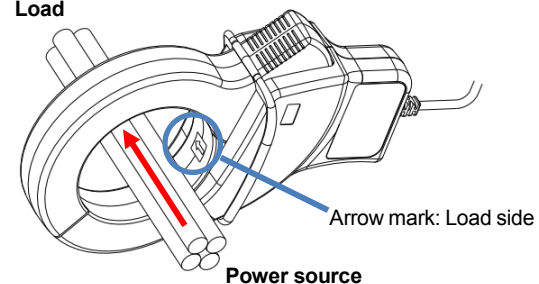

Wiring diagram

Detail				
Load current, voltage logger(A)	Single-phase 2-wire (1P2W)	Single-phase 3-wire (1P3W)	Three-phase 3-wire (3P3W)	Three-phase 4-wire (3P4W)
× 1 – 4 systems	× 1 – 4 systems	× 1 – 4 systems	× 1 – 4 systems	× 1 – 4 systems

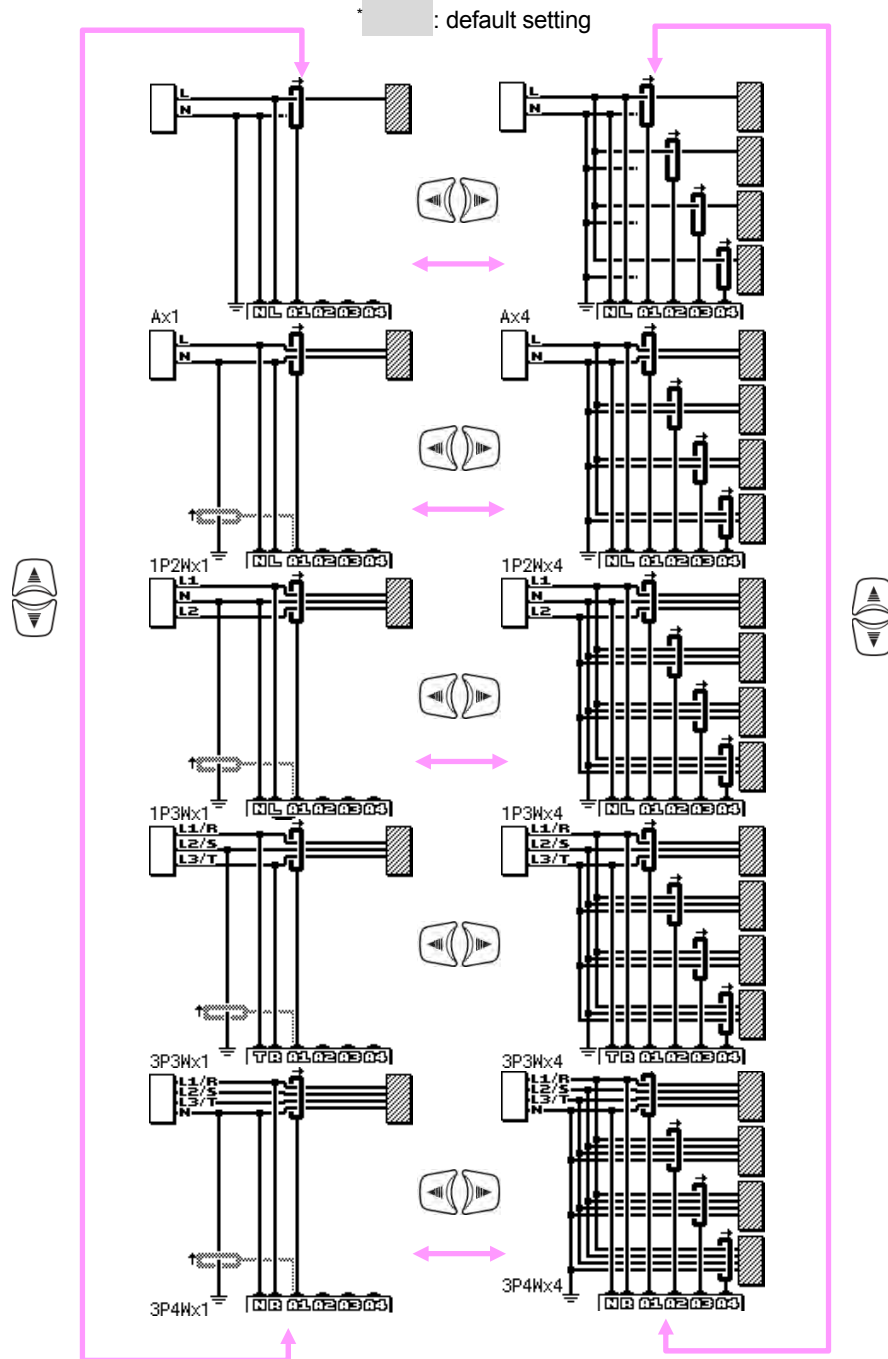

5.7 Recording procedure

How to start recording

Press .

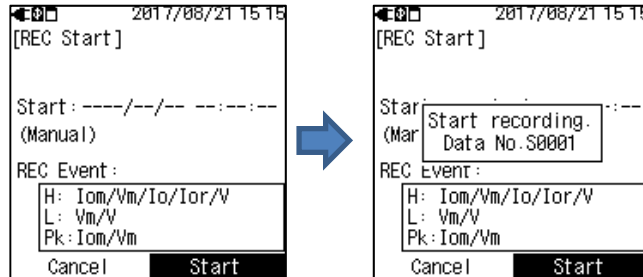

The LCD shows the currently applied recording settings before a start of recording. Select **Start** to start recording with the displayed settings. To change the settings, select **Cancel** and press  to change the settings. Always check and follow the safety precautions and do proper preparation before starting measurement.

: Move the highlight to **Cancel/ Start** →  Confirm  Cancel

How to stop recording

Press .

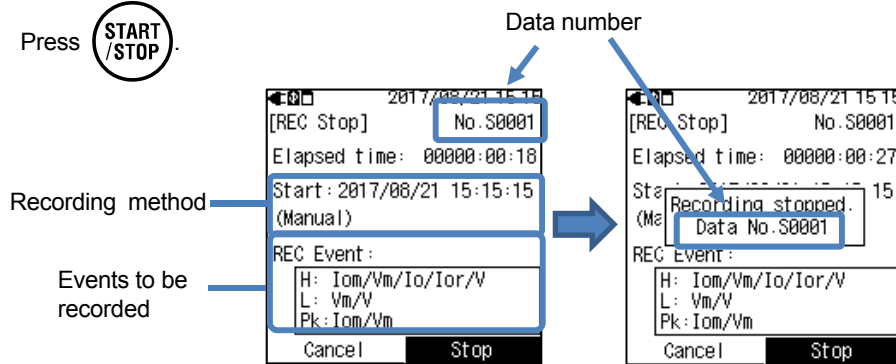

Displayed items		
Data No.	Data no. of the recorded data. It is also used as a folder name to save data.	
Elapsed time	The time that elapsed while recording.	
Recording method	Manual	Shows recording start date and time.
	Constant	Shows recording start/ stop date and time.
	Time period	Shows recording period and time.
REC Event	Events to be recorded and compared with criteria of judgement.	

 Move the highlight to **Cancel/ Stop** →  Confirm  Cancel

6. Settings

Before starting a measurement, make settings for measurement conditions and data saving.

Press **SET UP** and show the wiring diagram screen  first. Select an appropriate diagram and press

ENTER to proceed with detail settings. Press **SET UP** or **ESC** to return to the previous screen.

Moving the highlighted cursor

Basically,  is to move the highlighted cursor, **ENTER** is to confirm the change/ selection, **ESC** is to return to the previous settings. The following example shows how to make settings for current clamp sensors. The other input operations are basically the same.

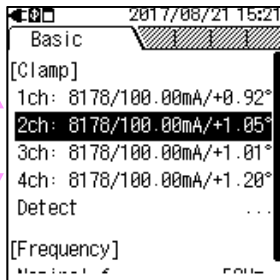



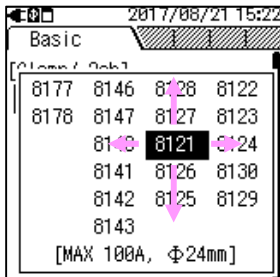

The item with **white text with black background** indicates the item currently selected.

In this example, press  to move the highlight to select a clamp for each CH and **ENTER** to confirm the selection. Press **ESC** to return to the previous screen.

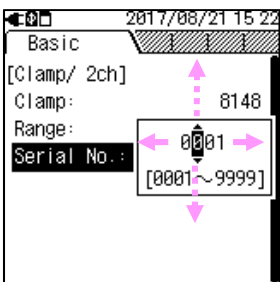

If the display of the selectable items is like the one shown to the left, the highlighted cursor can move to up, down, right and left. Use  keys and select the sensor to be connected, and then press **ENTER** to confirm. To return to the previous screen and cancel the changes, press the **ESC** key.



To alter the numbers such as serial no., date and time, move the highlighted cursor with  keys and alter the number with  keys. In the example shown to the left, the hundreds place of serial no. is being selected. The number can be increased or decreased by 1 with  keys. Press **ENTER** to confirm the selection, or press **ESC** key to return to the previous screen without making changes.

6.1 Detail settings

Detail settings consist of the following five items. Use  keys to move between screens.

Note

Press **SET UP** and move to another screen to reflect changes in settings. Turning off the Product without moving screens doesn't change settings.

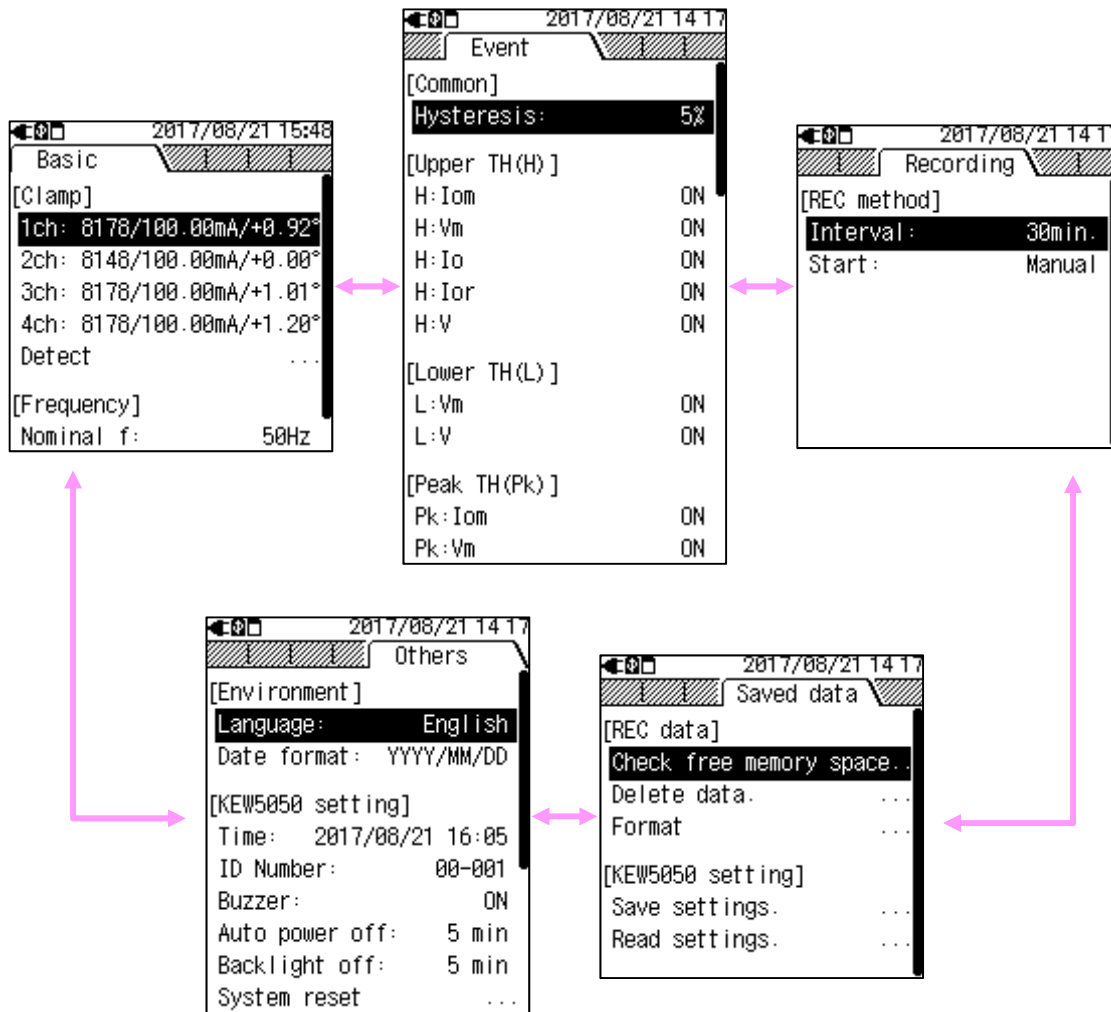

6.2 Basic setting

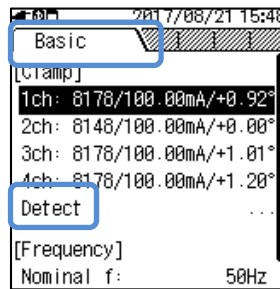

Use  to move to "Basic setting" tab.

Sensor recognition

Auto-configuration works only for Ior leakage clamp sensor

Connect Ior leakage clamp sensor(s) to the Product and perform sensor detection. Type of the sensor, serial no. and phase correction value are automatically updated. If the connected sensors are not the same ones used at the previous test, "!" symbol is displayed to the left of the CH number.

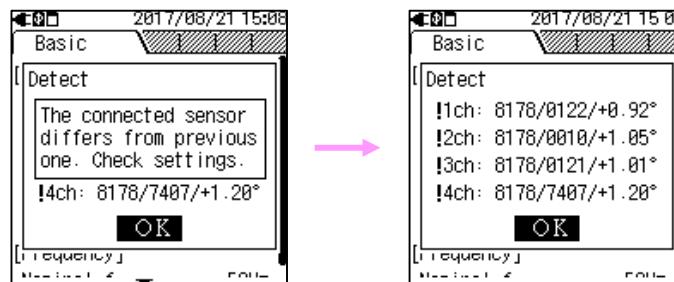

Manual configuration is required for general purpose leakage clamp sensor or load current clamp sensor; the settings aren't updated automatically.

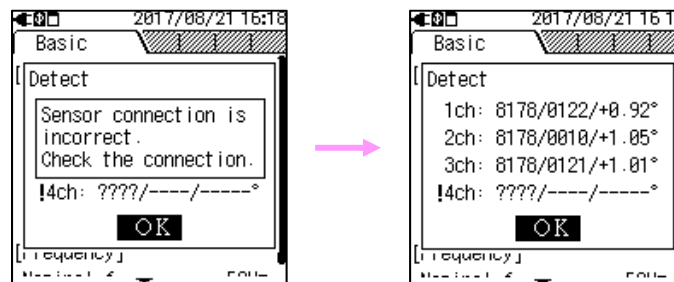

Press  to move to "Detect" →  Start sensor detection/  Cancel

Check the followings if sensor detection failed.

Check	Remedies
Type of current clamp sensor	KEW5050 automatically identifies lor leakage clamp sensors only. Manual configuration is required when using general purpose leakage clamp sensor or load current clamp sensor.
??? (Identification error)	<ul style="list-style-type: none"> - Current clamp sensors are firmly connected to the Product? - If any failure is in doubt: Disconnect the sensor, for which "NG" is given and connect to the different CH on which another sensor is properly detected. If the result "NG" is given for the same CH, a defect of the Product is suspected. A defect of sensor itself is suspected if "NG" is given for the same sensor. Stop using the Product and the sensor, if any defects are in doubt.

Current clamp sensor/ ch

Follow the procedure below and make detailed settings for current clamp sensor.

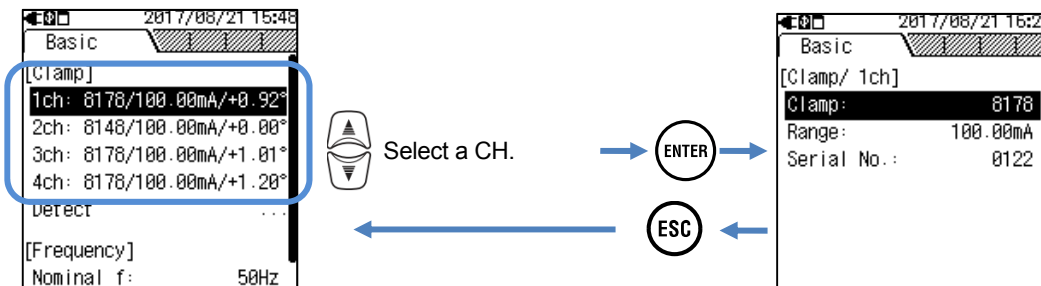

Clamp sensor:

Select the model name of the sensor to be used. When locating the highlighted cursor to any of the listed clamp sensors, rate current and conductor size information are displayed for easy recognition.

Selection	
lor leakage clamp sensor	
8177/8178	:10.000mA/100.00mA/1000.0mA/10.000A/AUTO
General purpose leakage clamp sensor	
8146/8147/8148	:10.000mA/100.00mA/1000.0mA/10.000A/AUTO
8141/8142/8143	:5.000mA/50.00mA/500.0mA/1.000A/AUTO
Load current clamp sensor	
8128	:500.0mA/5.000A/50.00A/AUTO
8121/8127	:1000mA/10.00A/100.0A/AUTO
8126	:2.000A/20.00A/200.0A/AUTO
8122/8125	:5.000A/50.00A/500.0A/AUTO
8123/8124/8130	:10.00A/100.0A/1000A/AUTO
8129	:300.0A/1000A/3000A

*  : default setting



Range:

Select a desired current range.

Note

- When "AUTO" is set, event detection on the subjected CH is **automatically set to "OFF"**. Select a fixed range to enable the event detection function.

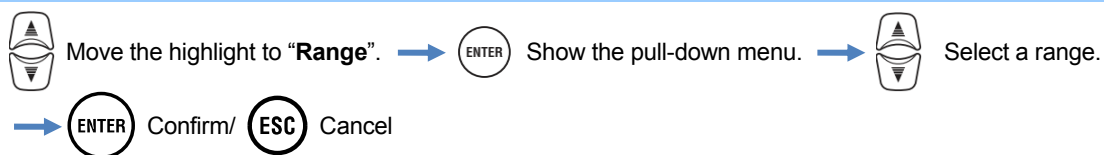

Serial No. :

Leakage current clamp sensors used for a measurement can be searched on the application by registering a serial no. of the sensor beforehand.

lor leakage clamp sensor

Serial no. is automatically registered when connected to the Product and do sensor detection, or power on the Product or start recording. The serial numbers, which have already been registered, are selectable from the list. The registered serial no. cannot be cleared.

General purpose leakage clamp sensor

First, select "New" and then enter the number labeled on the sensor. The entered number is selectable from the list. After entering the number, the currently selected number (serial no. of currently selected general purpose leakage clamp sensor) can be cleared; move down the highlight to "Delete serial number".

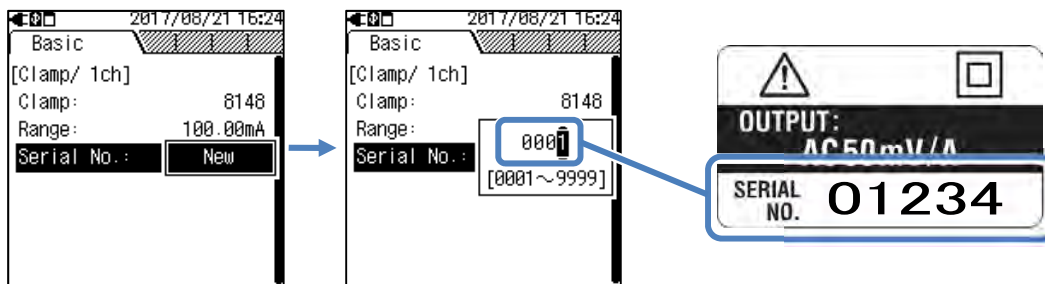

Load current clamp sensor

Cannot enter serial number of load current clamp sensor. No entry window opens.

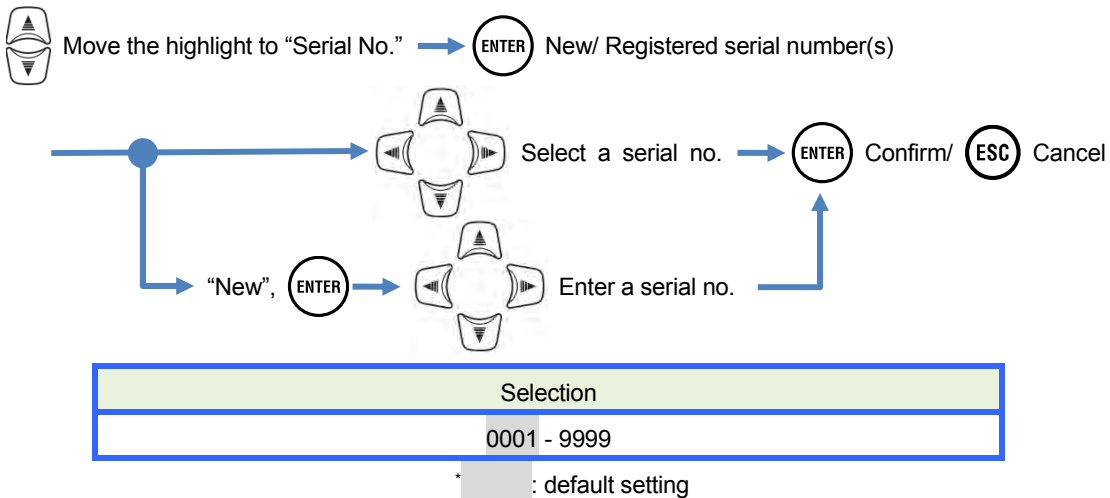

Frequency

Choose the nominal frequency of the system to be measured. If voltage frequency is uncertain; for example, in the event of power interruption, the Product performs measurements based on the preset nominal frequency.

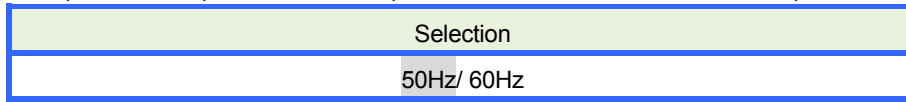

* : default setting

Move the highlight to "Nominal f" → Show the pull-down menu.

→ Select a frequency. → Confirm/ Cancel

6.3 Event setting

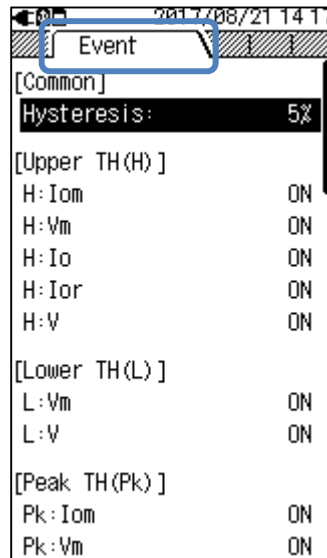

Use to move to "Event" tab.

Common settings to all events

Hysteresis :

Set a desired hysteresis in percentage to disable the event detection in the specific area. Setting a proper hysteresis will be helpful to prevent unnecessary detection of events which are caused by voltage or current fluctuations around the threshold values.

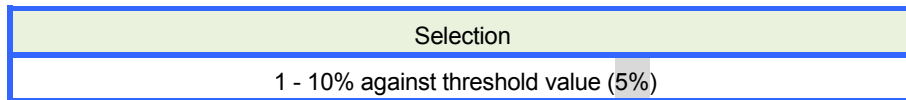

* : default setting

Move the highlight to "Hysteresis". → Show the value entry window.* →

* A pop-up appears and show the effective range.

Enter hysteresis value (%). → Confirm/ Cancel

Upper threshold value (H)/ ch

The following shows how to set upper threshold values.

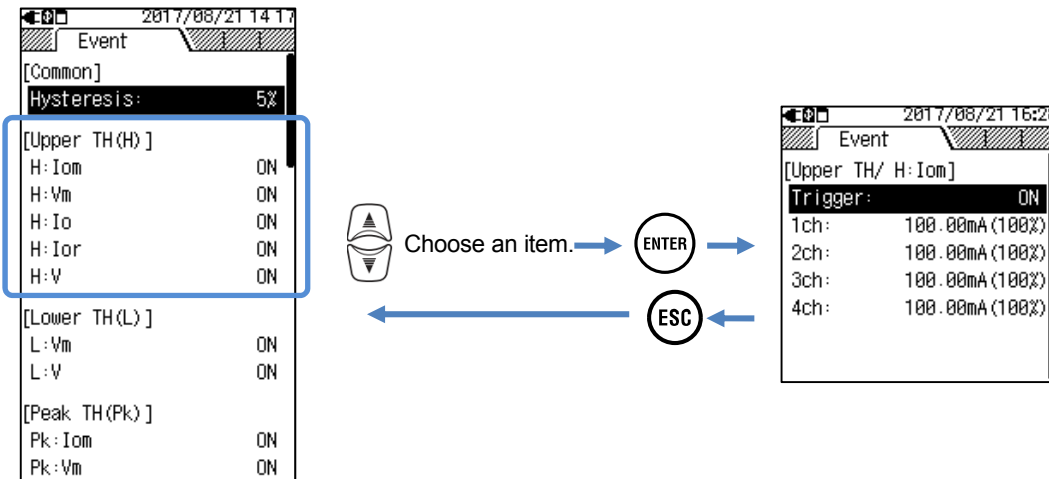

Selection	
Upper TH (H):	RMS leakage current (rms) :Iom
	RMS reference voltage :Vm
	Leakage current :Io
	Resistive leakage current :Ior
	Reference voltage :V

Trigger:

Choose and set "ON" to enter threshold value for each event. The event with "ON" setting is applied to all CHs. To disable event detection on a certain CH, set the Current range to "AUTO" or adjust the threshold value for the subjected CH.

Note

- While Current range setting has been set to "AUTO", "ON" cannot be set for current-related event. Choose an appropriate current range, and then select "ON".

Selection	
	ON/ OFF

* : default setting

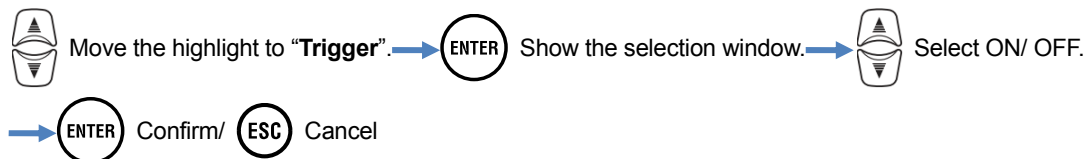

ch:

Set the upper Trms threshold value, which is determined at every 200 ms, to the max value of each range. For this threshold value, the pre-set hysteresis value is applied.

Note

- Upper threshold values for Trms leakage current is set in percentage against each current range; therefore, current value for the threshold value changes if Current range settings are changed. Reference voltage range is fixed to 1000V.

Selection
0 - 100% against voltage range (100%)
0 - 110% against current range (100%)

* : default setting

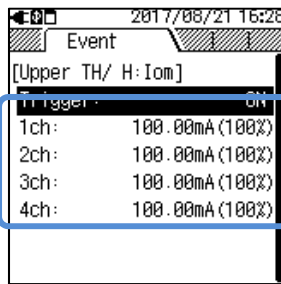

Move the highlight to a desired CH. →



Show the value entry window.*

* A pop-up appears and show the effective range.

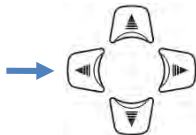

Enter values. →



Confirm/



Cancel

Detection example: * Trms values measured at every 200ms (50/60Hz: 10/12-cycle)

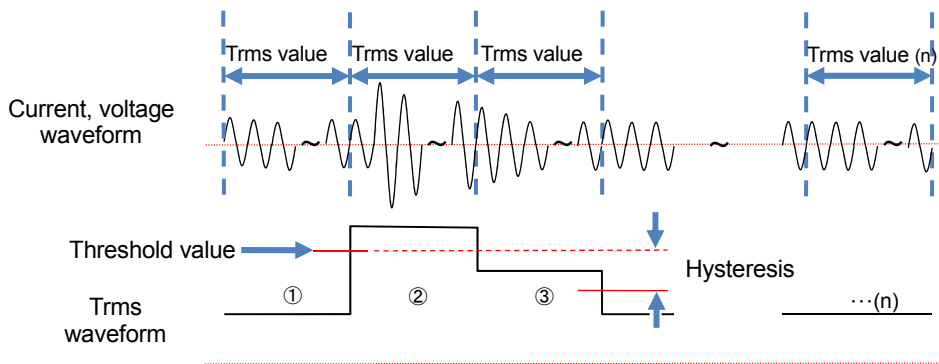

Lower threshold value (L)

The following shows how to set lower threshold values.

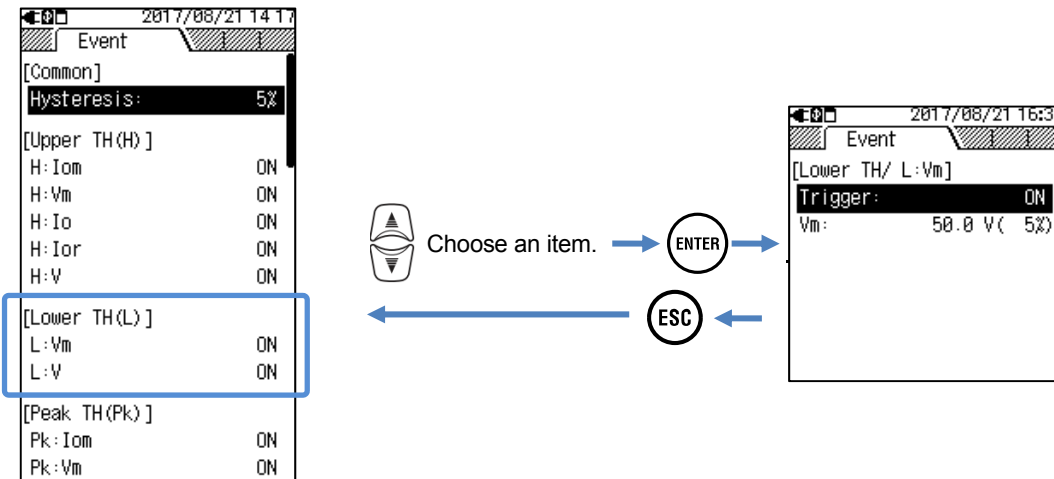

Selection	
Lower TH (L):	Trms reference voltage :Vm
	Reference voltage :V

Trigger:

Choose and set "ON" to enter threshold value for each event.

Selection	
	ON/OFF

* : default setting

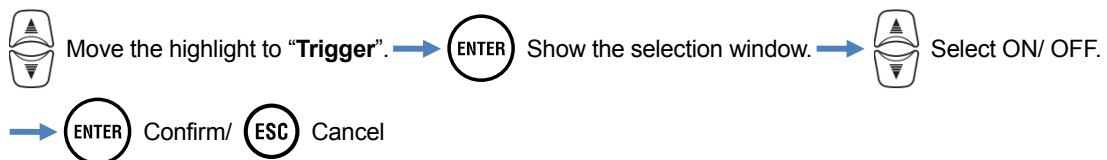

Vm:V:

Set the lower threshold value of reference voltage, which is determined at every 200 ms, to the max value (1000V) of the range. For this threshold value, the pre-set hysteresis value is applied.

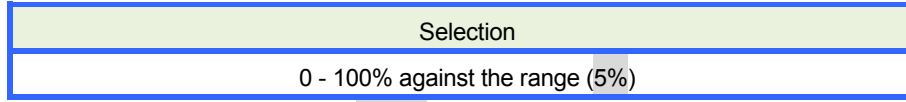

* [Grey box] : default setting



Move the highlight to the event item. → [ENTER] Show the value entry window.*

* A pop-up appears and show the effective range with Trms value.

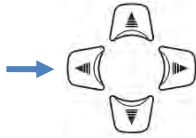

Enter a percentage against max value of the range. → [ENTER] Confirm/ [ESC] Cancel

Detection example: * Trms values measured at every 200ms (50/60Hz: 10/12-cycle)

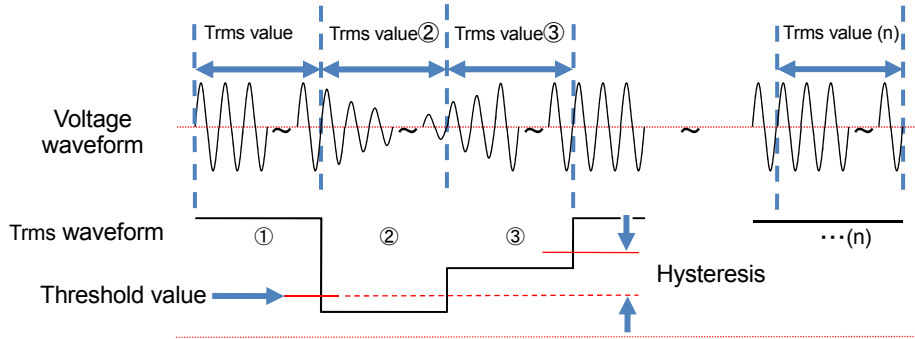

Peak threshold value (Pk)/ch

The following shows how to set peak threshold values.

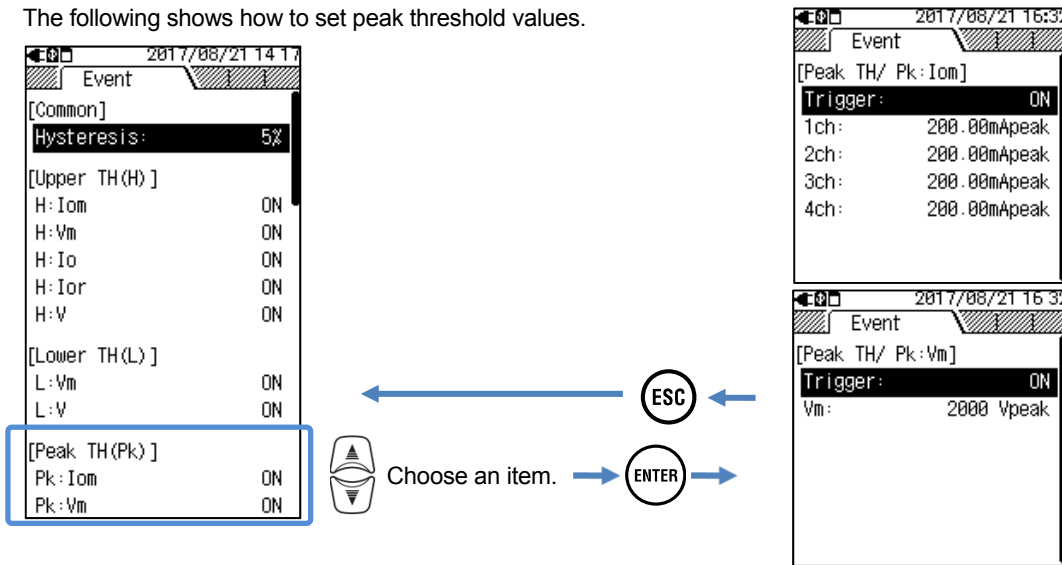

Selection	
Peak TH (Pk):	Trms leakage current :Iom
	Trms reference voltage :Vm

Trigger:

Choose and set “ON” to enter threshold value for each event. The event with “ON” setting is applied to all CHs. To disable event detection on a certain CH, set the Current range to “AUTO” or adjust the threshold value for the subjected CH.

Note

- While Current range setting has been set to “AUTO”, “ON” cannot be set for current-related event. Choose an appropriate fixed current range, and then select “ON”.

Selection	
	ON/ OFF

* : default setting

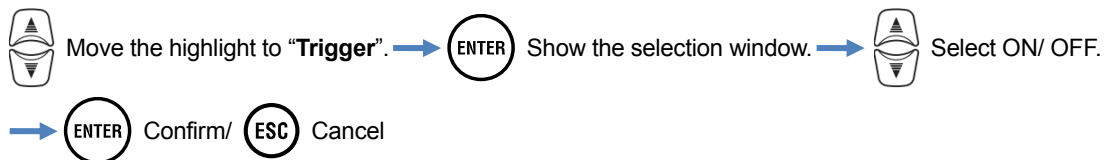

Iom, ch: / Vm:

Set threshold values for leakage current and reference voltage by setting instantaneous current and voltage peak values.

Note

Threshold current value changes to 200%Apeak of the range when current range settings are changed.
Reference voltage range is fixed to 1000V.

Selection	
Iom:	1.5%Apeak(1mA) - 200%Apeak(200%Apeak) to current range
Vm:	50 V - 2000 Vpeak(2000Vpeak)

* [Grey Box] : default setting

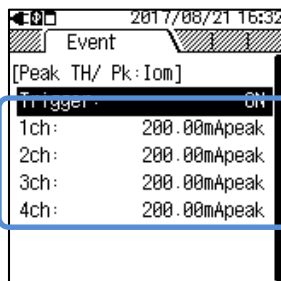

Move the highlight to a desired CH. → **ENTER** Show the value entry window.*

* A pop-up appears and show the effective range.

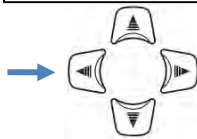

Enter a voltage peak value. → **ENTER** Confirm/ **ESC** Cancel

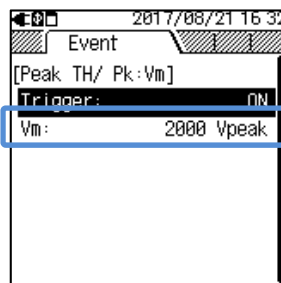

Move the highlight to the event item. → **ENTER** Show the value entry window.*

* A pop-up appears and show the effective range with Trms value.

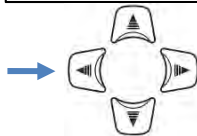

Enter a voltage peak value. → **ENTER** Confirm/ **ESC** Cancel

Peak threshold value

Trms leakage current (Iom), Trms reference voltage (Vm)

Set threshold values for leakage current and reference voltage by setting instantaneous current and voltage peak values.

Selection	
Iom:	1.5%Apeak(1mA) - 200%Apeak (200%Apeak) to current range
Vm:	50 V - 2000 Vpeak (2000Vpeak)

* : default setting

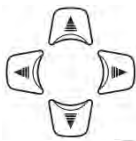

Move the highlight to a desired CH. →



Show the value entry window.*

* A pop-up appears and show the effective range.

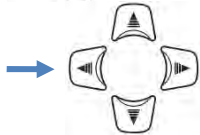

Enter a voltage value. →



Confirm/



Cancel

Detection example

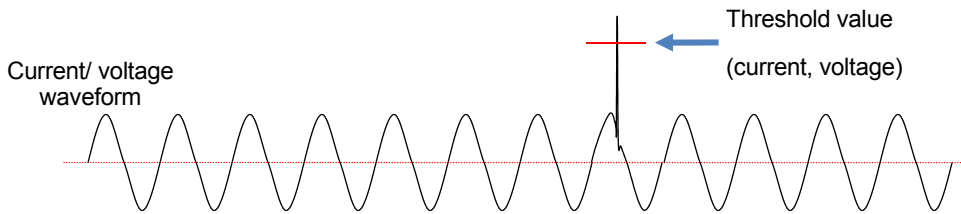

6.4 Recording setting



Use  to move to "Recording" tab.

Recording method

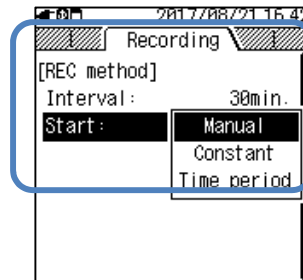

Interval

Set the interval to record the measured data on the SD card. Twelve different intervals are available.

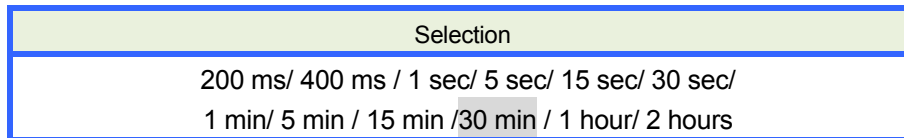



*  : default setting

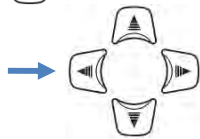

Move the highlight to "Interval". →  Show the selection window.



→ Select a desired interval. →  Confirm/  Cancel

Start recording

Select the method to start recording.

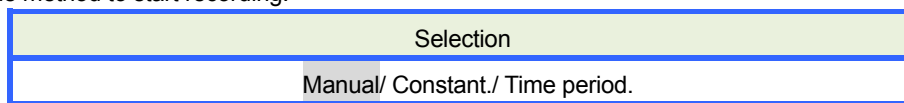

*  : default setting



Move the highlight to "Start". →  Show the pull-down menu.



→ Select a desired recording start method. →  Confirm/  Cancel

“Manual”

Start/ stop the recording with  key.

“Constant”: Constant recording



Measured data will be recorded continuously at the preset interval during the specified start/ stop time and date.

	Selection
Start time and date	Day/ Month/ Year Hour: Minute (00/00/0000 00:00)
Stop time and date	Day/ Month/ Year Hour: Minute (00/00/0000 00:00)

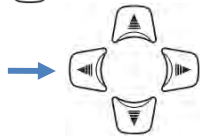

Move the highlight to “Start”/ “Stop”. →  Show the entry window.



→ Specify the time and date. →  Confirm/  Cancel

When the time period is specified as below, the recording period will be from 6:10 am May 30, 2017 to 10:20 am June 10, 2017.

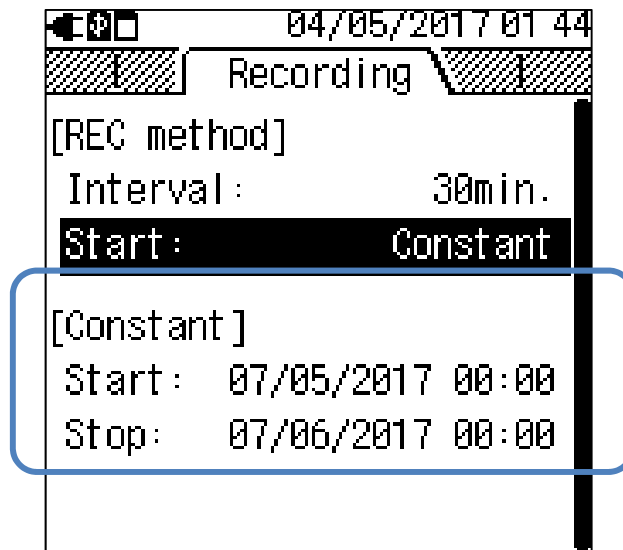

“Time period”: Time period recording

Measured data will be recorded at the preset interval for the specified time period of the selected period. When the specified time comes, a recording will start and stop automatically; such a recording cycle will be repeated every day during the specified period.

		Selection
REC Period	Start-Stop	Day/ Month/ Year (DD/ MM/ YYYY) - Day/ Month/ Year (DD/ MM/ YYYY)
REC Time	Start-Stop	Hour:Minute (hh:mm) - Hour:Minute(hh:mm)

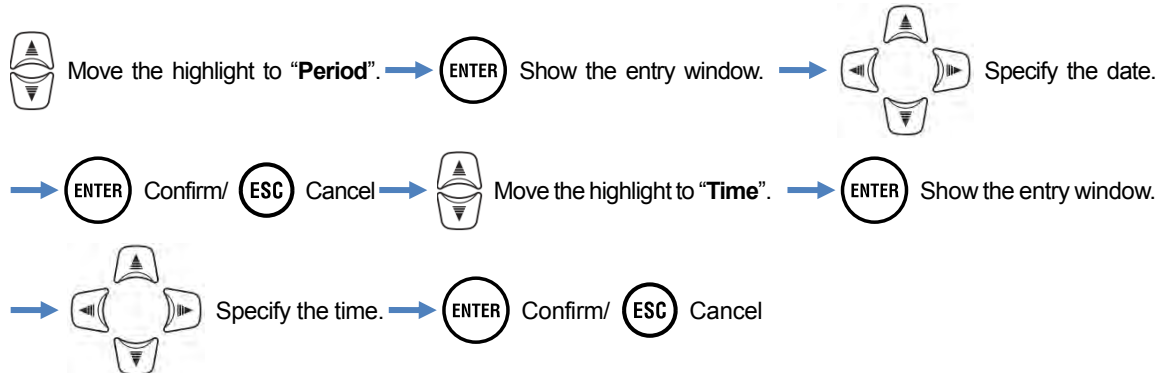

When the period and time are specified as below, the Product records the results from 6:10 am to 8:30 am every day from May 20, 2017 through June 10, 2017. In the time other than specified above, no recording is performed.

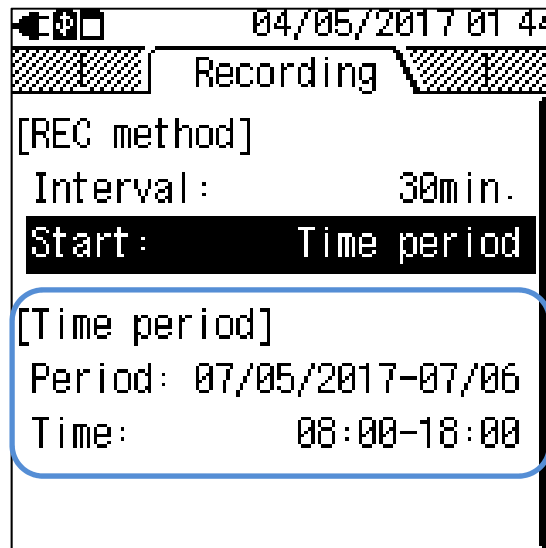

Possible recording time

Note

- Use the SD card supplied with the Product or the one supplied as optional parts.
- Newly purchased SD cards must be formatted on the Product before use. Data might not be successfully saved on SD card formatted on a PC. For the details, please refer to “Format” (P. 58) in this manual.
- Remaining recording time length varies depending on the volume of recorded events. Event data up to 1GB can be saved on the SD card per recording.

The following table shows possible recording time length when using a 2GB SD. (No event recording.) These are just reference values since measurement conditions or environment affect the possible recording time length. When setting the interval to 400 ms not only instantaneous value but also average, max, and min values are recorded; thus, possible recording time becomes shorter than the one with 200 ms interval setting.

Interval	Possible recording time
200 ms	7 days
400 ms	3 days
1 sec	9 days
5 sec	6.7 months
15 sec	20 months
30 sec	40 months
1 min	6.7 years or more
5 min	33 years or more
15 min	100 years or more
30 min	200 years or more
1 hour	
2 hours	

6.5 Saved data



Use  to move to "Saved data" tab.

Recorded data



Select a desired item. →  Confirm

"Check free memory space"

Checking the available space in the SD card which has been set in the Product.

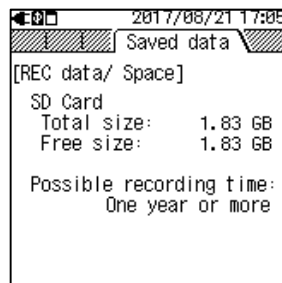

Press  to return to "Saved data" screen.

Displayed items		Description
Capacity	Total size	Total memory capacity
	Free size	Capacity of free space
Possible recording time		Estimated possible recording time with the present interval settings.

"Delete data"

Select and delete unnecessary files. Select a file with reference to the date info displayed to the right of the file name. Files are listed in random order. Each prefix of file name indicates the type of the data: S0001 – 9999 for measurement data, PS-SD000 – 999 for screenshot and SUPS0000 – 9999 for KEW5050 settings. The scroll bar is displayed when the list of the recorded data exceeds the display area.

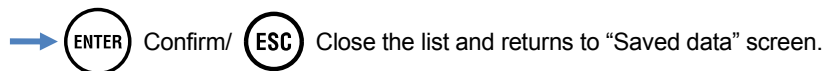
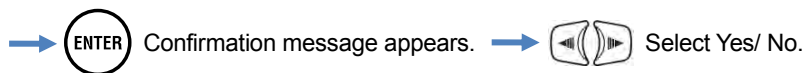
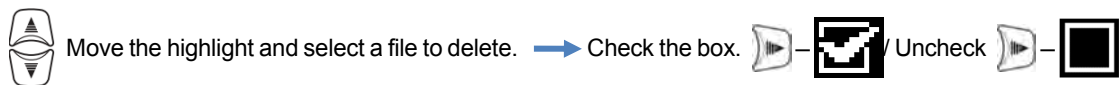
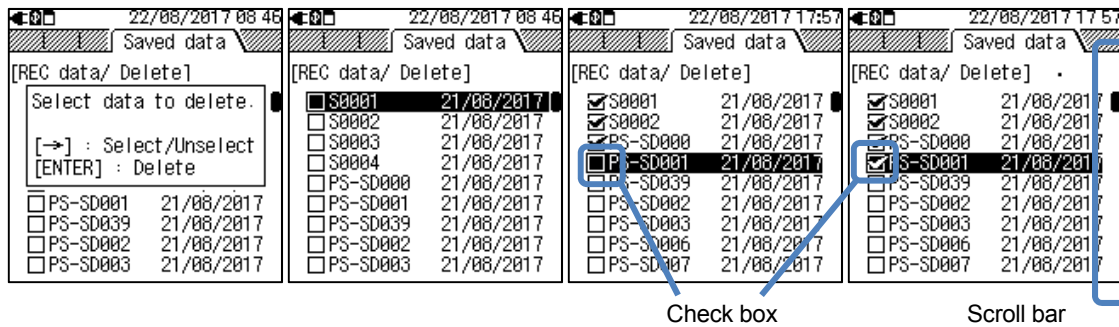

When pressing and select a file to delete, the corresponding checkbox is checked to indicate the file is being selected. Multiple files can be selected at once.

"Format"

Format the SD card. Formatting is to completely erases all data on the card. The scroll bar is displayed when the list of the recorded data exceeds the display area.

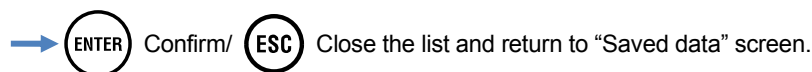
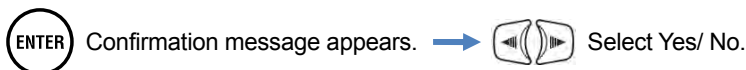
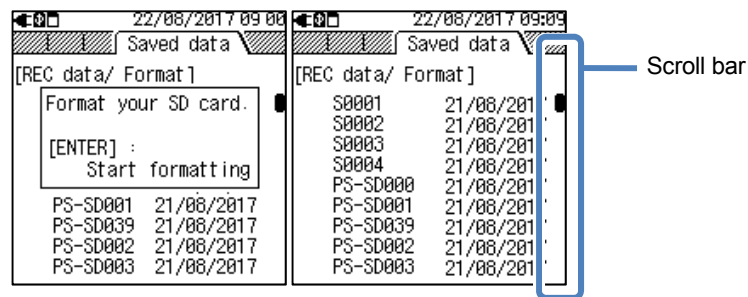

KEW5050 settings

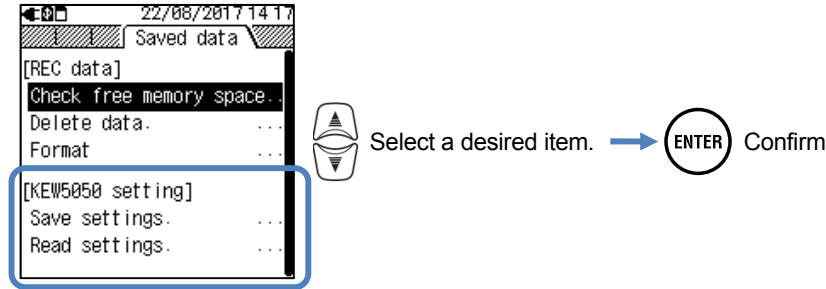

Save settings

Save KEW5050 setting data, SUPS0000 – 9999, on the SD card. Data is listed in random order. The scroll bar is displayed when the list of the recorded data exceeds the display area.

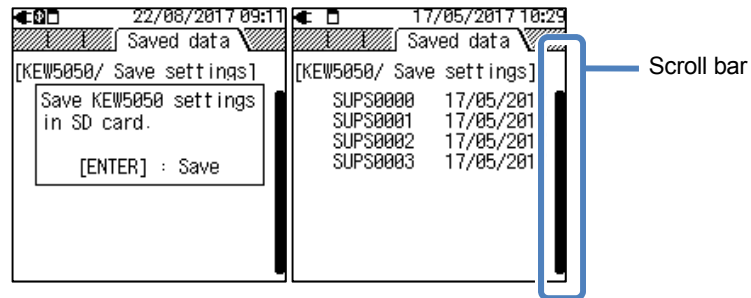

ENTER Confirmation message appears. → Select Yes/ No.

→ ENTER Confirm/ ESC Close the list and return to “Saved data” screen.

KEW5050 retains the following configurations.

Basic setting

Setting item
Wiring
Clamp/ Serial no./ Current range
Frequency

Other settings

Setting item	
Environment	Date format
KEW5050 setting	ID number Buzzer

Event setting

Setting item			
Hysteresis:			
Upper TH (H):	Trms leakage current: Iom	ON/OFF	threshold for 1-4ch
	Trms reference voltage: Vm	ON/OFF	threshold
	Leakage current: Io	ON/OFF	threshold for 1-4ch
	Resistive leakage: Ior current	ON/OFF	threshold for 1-4ch
	Reference voltage: V	ON/OFF	threshold
Lower TH (L):	Trms reference voltage: Vm	ON/OFF	threshold
	Reference voltage: V	ON/OFF	threshold
Peak TH (Pk):	Trms leakage current: Iom	ON/OFF	threshold for 1-4ch
	Trms reference voltage: Vm	ON/OFF	threshold



Recording setting

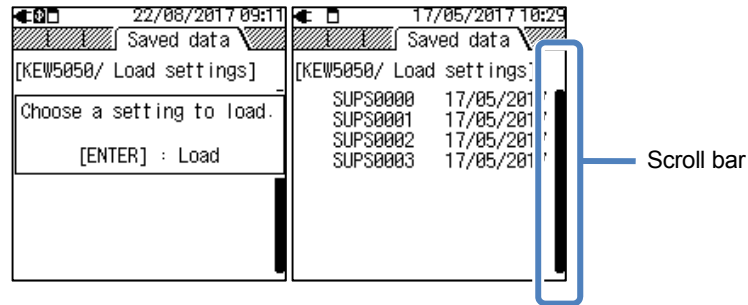

Setting item	
Recording method	Interval
	Start
Constant	Start
	Stop
Time period	Period Start – Stop
	Time Start – Stop

“Read settings”

Read KEW5050 setting data, SUPS0000 – 9999, from the SD card. Data is listed in random order. Select a desired file with reference to the date information displayed to the right of the file name. The scroll bar is displayed when the list of the recorded data exceeds the display area.



 Select a file to transfer. →  Confirmation message appears. →  Select Yes/ No.

→  Confirm/  Close the list and returns to “Saved data” screen.

Types of saved data

! Data file handling

The file name will be assigned automatically. File no. is kept and saved, even after powering off the Product, until the system is reset. The file number will increase until it exceeds the max file number.

Note

- If a file with the same file name already exists on the SD card, the files in the data folder will be saved as another name with a different file number; however, “print screen” and “KEW5050 setting” files will be overwritten in such a case. Attention should be paid so as not to duplicate the same file names after system reset (file number starts from “0”) or when one same SD is used for multiple KEW5050 units. When all the file numbers (S0000 – S9999) are used for each type of data, the files on the data folder will be overwritten.
- The Product cannot handle the files or folders which are deleted, renamed or saved on a PC; moreover, such files or folders cannot be analyzed with the special software. Please do not change the name of folder or file.

“Print screen”

Press  to save the screen images as BMP files.

File name: PS-SD 000 .BMP

File no. (000 - 999)	Extension (BMP file)
-------------------------	-------------------------

“KEW5050 Setting”

Press  and move to “Saved data” tab, and then select “Save Settings”.

File name: SUPS 0000 .KEW

File no. (0000 - 9999)

“Data folder”

New folder will be created per measurement to save the measured data.

Folder name: /KEW/ S0000

File no. (0000 - 9999)

“Measured data”

KEW5050 setting data* File name: INIS 0000 .KEW

Interval data DATS

Event data EVTS

*(at the start of recording)

File no. (0000 - 9999)

6.6 Others

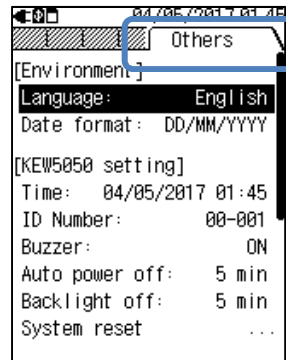

Use  to move to "Others" tab.

Environmental settings

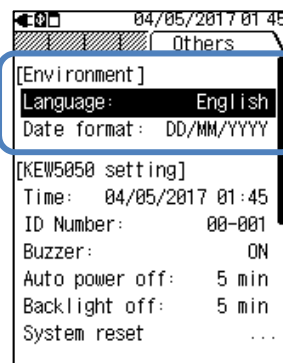

"Language"

Select the language to be displayed.

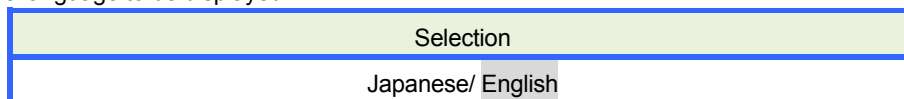

* Default setting is highlighted in gray. Changes made by user will remain after system reset.



Move the highlight to "Language".



Show the pull-down menu.



Select a

desired language.



Confirm/



Cancel

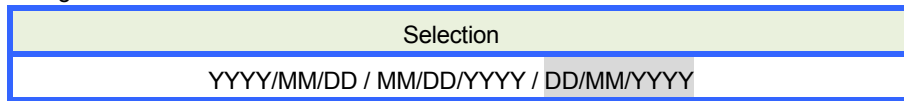

“Date format”

Select a desired date display format. The selected date format will be reflected to all the displayed screens and on each setting window.



* Default setting is highlighted in gray. KEW5050 retains changes made by user even after system reset.

 Move the highlight to **“Date format”**. →  Show the pull-down menu.

→  Select a desired date format. →  Confirm/  Cancel

KEW5050 system settings

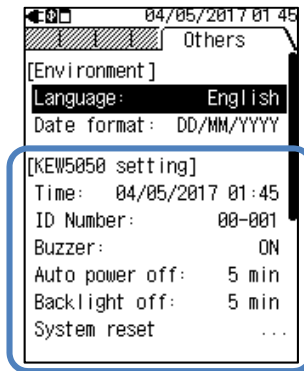



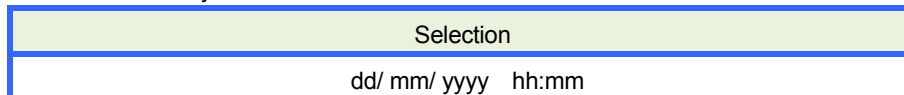

“Time”

Adjust and set the internal system clock.

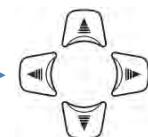

* The selected date format is reflected to the input format.

 Move the highlight to **“Time”**. →  Show the entry window.

→  Adjust the date and time. →  Confirm/  Cancel

“ID Number”

Assign an ID number for the unit. Assigning ID numbers will be helpful when using multiple units at the same time, measuring multiple systems periodically with one unit and analyzing the recorded data.

Selection
00-001 to 99-999

* : default setting



Move the highlight to “ID Number”. → (ENTER) Show the value entry window.

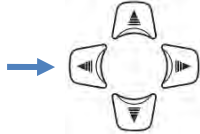

Enter an ID number. → (ENTER) Confirm/ (ESC) Cancel

“Buzzer”

Mute the keypad sound. This setting doesn't affect a waning buzzer for low battery power.

Selection
On/ Off

* : default setting



Move the highlight to “Buzzer”. → (ENTER) Show the pull-down menu. → (Up/Down Arrow) Select On/ Off.

→ (ENTER) Confirm/ (ESC) Cancel

“Auto power off”

Select to enable or disable the auto-power-off function. While the Product is operating with batteries, “Disable” cannot be set to save battery life.

For:	Selection
AC Power	5 min./ Disable
Battery	2 min. (fix)

* : default setting



Move the highlight to “Auto power off”. → (ENTER) Show the pull-down menu.



Select to disable/ enable auto-power-off. → (ENTER) Confirm/ (ESC) Cancel

“Backlight off”

Select to turn off/ not to turn off the backlight automatically when a certain time passes after the last key operation. While the Product is operating with batteries, “Disable” cannot be set to save battery life.

For:	Selection
AC Power	5 min./ Disable
Battery	2 min. (fix)

* : default setting



Move the highlight to “Backlight off”. → **ENTER** Show the pull-down menu.



Select to disable/ enable auto-off. → **ENTER** Confirm/ **ESC** Cancel

“System reset”

Restore all the settings to default except for “Language”, “Date format” and “Time”.



Move the highlight to “System reset”. → **ENTER** Confirmation message appears.



Select “Yes” or “No”. → **ENTER** Confirm/ **ESC** Cancel

7. Displayed Items

7.1 Measured values

List display of measured values by system

Measured values per system is displayed on one screen. If measurements are done on multiple systems, the result of entire system is displayed first.

List display

Example: 3P3W (Three-phase 3-wire, 1-system)

2017/05/18 08:50	
LOAD1/ Meas.	
Io1	10.02 mA
Ior1	11.39 mA
Iom1	10.00 mA
R1	0.00 MΩ
V	240.0 V
f	50.0 Hz

* On a wiring system of 3P3W, *Ior* is bigger than *Io* if *Io* flows in the phase between R and T phase voltages.

* The number following alphabets indicates the system number.

Symbols displayed on the LCD			
Io	Trms leakage current with basic wave of 50/ 60Hz only	Ior	Trms leakage current with resistive components only
Iom	Trms leakage current including harmonic components		
R	Insulation resistance is determined by V: Reference voltage (Trms, basic wave)/ Ior: Leakage current (Trms, resistive components) Note: Displayed value is just for reference since the measurement method differs from insulation resistance testers and may not be consistent with each other		
V	Trms reference voltage (Trms) with basic wave of 50/ 60Hz only	f	Frequency of reference voltage

“Switching the displayed systems”

Press  to toggle the screen to view the measurements on each system.

”Showing vector diagram for each system”

Press  to show a vector diagram.

Displaying vector diagram

Vector diagram for each system is displayed on one screen.

Vector diagram

Example: 3P3W (Three-phase 3-wire)

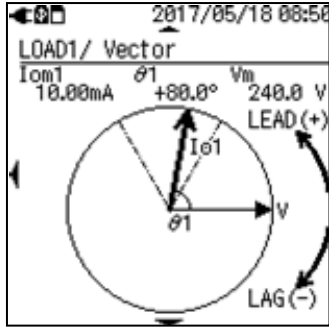

- Solid line "V" (→) Vector of reference voltage basic waveform
- Solid line "Io" (→) Vector of Trms leakage current (basic waveform)
- Dotted line (- - - -) Other voltage except for reference voltage basic waveform
- Arc θ (Δ) Phase angle

* The number following alphabets indicates the system number.

Symbols displayed on the LCD				
Iom	Trms leakage current including harmonic components * vector line indicating Ior phase angle		Vm	Trms reference voltage including harmonic components
θ	Phase angle	0 to +180 leading 0 to -180 lagging	Phase angle of the basic wave of leakage current: phase angle of the basic wave of reference voltage is regarded as 0°.	

Vector diagrams will be as follows where there are no resistive capacitance components, and voltage and current are balanced. If the phase of *Io* is outside of the following range, orientation of clamp sensor or polarity of alligator clip may be incorrect.

* Regarding reference voltage (V) as 0°

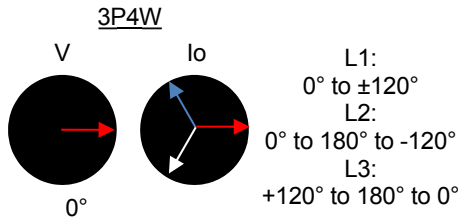
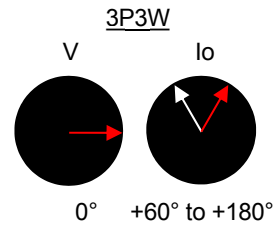
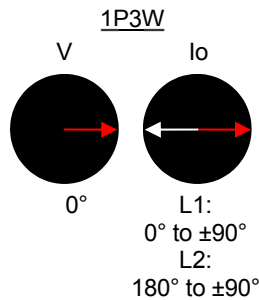
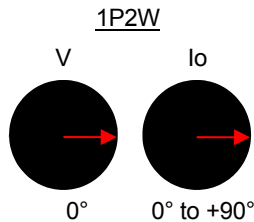

“Switching the displayed systems”

Press  to toggle the screens to view the measurements on each system.

”Showing measured values on each system”

Press  to show the measured values.

Displaying measured values of entire system

Measured values of entire system are summed and displayed on one screen. This screen doesn't appear when the system to be measured is just one; only one screen (LOAD 1) is available. The number following alphabets indicates the system number; the symbol without number indicates the displayed value is the sum of all systems.

List display

Example: 3P3W (Three-phase 3-wire, 4-system)

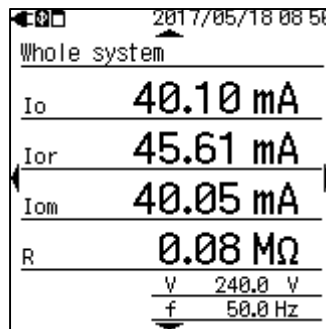

2017/05/18 08:50	
Whole system	
I_o	40.10 mA
I_{or}	45.61 mA
I_{om}	40.05 mA
R	0.08 M Ω
V	240.0 V
f	50.0 Hz

* On a wiring system of 3P3W, I_{or} is bigger than I_o if I_o flows in the phase between R and T phase voltages.

* The number following alphabets indicates the system number.

Symbols displayed on the LCD			
I_o	Trms leakage current with basic wave of 50/ 60Hz only	I_{or}	Trms leakage current with resistive components only
I_{om}	Trms leakage current including harmonic components		
R	Insulation resistance is determined by V : Reference voltage (Trms, basic wave)/ I_{or} : Leakage current (Trms, resistive components) Note: Displayed value is just for reference since the measurement method differs from insulation resistance testers and may not be consistent with each other.		
V	Trms reference voltage with basic wave of 50/ 60Hz only	f	Frequency of reference voltage

“Switching the displayed systems”

Press  to toggle the screen to view the measurements on each system.

“Showing the results by item”

Use  to switch the items to be displayed.

- “Whole system” : Total values displayed by item.
- “Leakage current” : List of I_0 values measured on all systems.
- “Resistive leakage current” : List of I_{or} values measured on all systems.
- “Leakage current rms” : List of I_{om} values measured on all systems.
- “Insulation resistance ” : List of R values measured on all systems.

7.2 Event

Press **EVENT** to view the information on the recorded events.

Another press of **EVENT** returns to the previous screen.

Displaying information on occurred event

The figure consists of three screenshots of a handheld device interface, illustrating the steps to view event information.

Top Screenshot: Shows the event configuration screen. At the top, it displays the date and time: 2017/05/09 10:54. Below this, there are two dropdown menus: "Type of events" (set to "DCRD") and "CH (system)" (set to "CH1"). A table lists event types and their occurrence counts per channel:

Event Type	Number of occurrence per CH (system)
V:	10
A1:	9
A2:	9
A3:	9
A4:	9

Middle Screenshot: Shows a list of events. At the top, it displays the date and time: 2017/05/09 10:56. Below this, there are two dropdown menus: "Pk: Trm" (set to "ALL") and "[Occurred]". A list of events is shown, each with an icon, a channel number, and a timestamp:

Event Type (+ icon)	Ch (system) no.	Time of occurrence (Hour: min.: second. ms)
[Icon]	Pk: Iom4	10:53:42.76
[Icon]	Pk: Iom3	10:53:42.76
[Icon]	Pk: Iom2	10:53:42.76
[Icon]	Pk: Iom1	10:53:42.76
[Icon]	Pk: Iom4	10:53:42.56
[Icon]	Pk: Iom3	10:53:42.56

Bottom Screenshot: Shows measured values. At the top, it displays the date and time: 2017/05/09 13:23. Below this, there are two dropdown menus: "[ALL]" and "[ALL]". A list of measured values is shown, each with a channel number and a value:

Channel	Value
L: V	79.7 V
L: Vm	79.7 V
Pk: Iom4	+16.05mA
Pk: Iom3	+16.15mA
Pk: Iom2	+15.77mA
Pk: Iom1	+15.42mA

Symbols displayed on the LCD			
Event symbol	Start		End
	Upper TH (H):	Trms leakage current	H:Iom
	Reference Trms voltage	H:Vm	H:Vm
	Leakage current	H:Ilo	H:Ilo
	Resistive leakage current	H:Ior	H:Ior
	Reference voltage	H:V	H:V
Lower TH (L):	Trms reference voltage	L:Vm	L:Vm
	Reference voltage	L:V	L:V
Peak TH (Pk):	Trms leakage current	Pk:Iom	Pk:Iom
	Trms reference voltage	Pk:Vm	Pk:Vm
OCRD (Number of occurrence)	Indicates how many times the event occurred. When an event occurred, the number increases by 1, and increase one more at the end of event; that is, increases by 2 in total.		
Ch (system) no.	Ch (system 1 – 4) on which events are detected.		
Date of occurrence	Date when the start/ end of event is detected.		
Time of occurrence	Time when the start/ end of event is detected.		
Measured value	Instantaneous values when the start/ end of event is detected. Measured values of a long-lasting event can be checked with the interval measurement data. Setting a short interval (200ms is the shortest interval) at event recording is recommended for better analysis.		

Adjusting display area

Press to scroll the screen vertically and adjust the display area.

Event extraction

◀ Selected item ▶ (blink) → Press to toggle the items* enclosed with “◀▶” → Confirm

→ [Selected item] Confirmed → Cancel * Event didn't occur will be skipped and not be displayed.

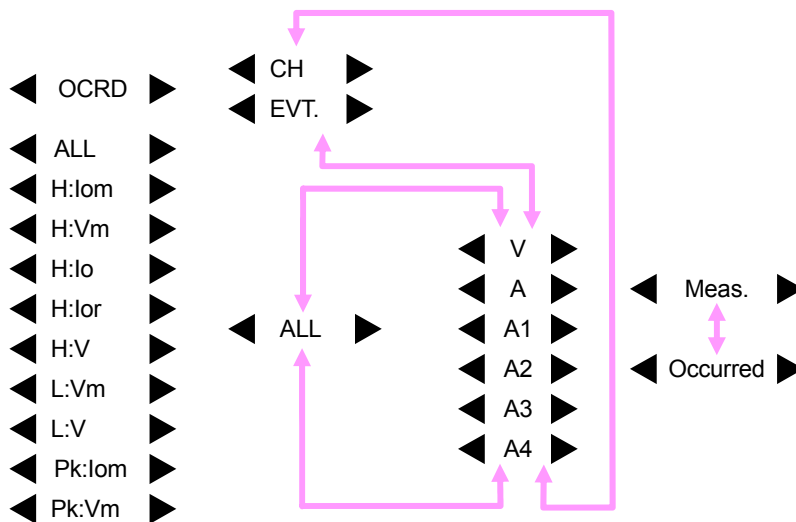

Measurement method of biggest/ smallest events

Each event is detected based on Trms values measured in approx. 200ms, gapless. When an event is detected, the beginning of the 200ms period where the event detected is regarded as the start time of the event. If further event is not detected in the following 200ms periods; the beginning of the waveform is regarded as the end of the event. The detected event is assumed to be continued between the start to the end of event detection.

Example of event detection (biggest event)

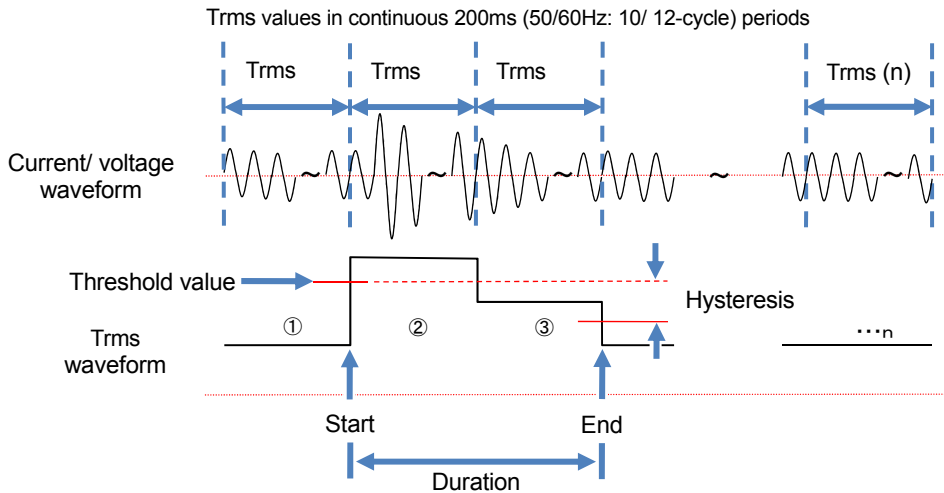

Example of event detection (smallest event)

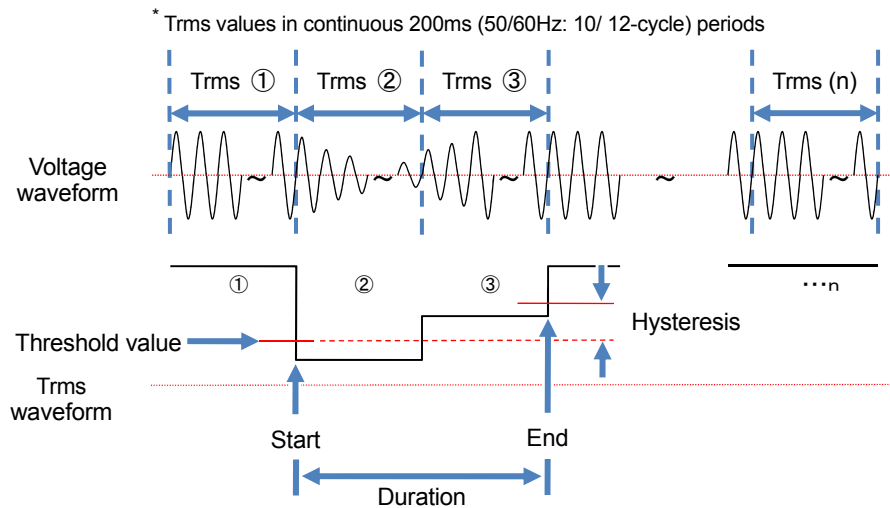

Detection of Peak event

Peak values are checked every 200ms, while monitoring waveforms of Trms leakage current and reference voltage at approx. 40ksps, gapless. The beginning of the 200ms period where the first peak event is detected is regarded as the start of the event. If further peak events are not detected in the following 200ms periods; the beginning of the waveform is regarded as the end of the event. The detected event is assumed to be continued between the start to the end of event detection.

Example of peak event detection

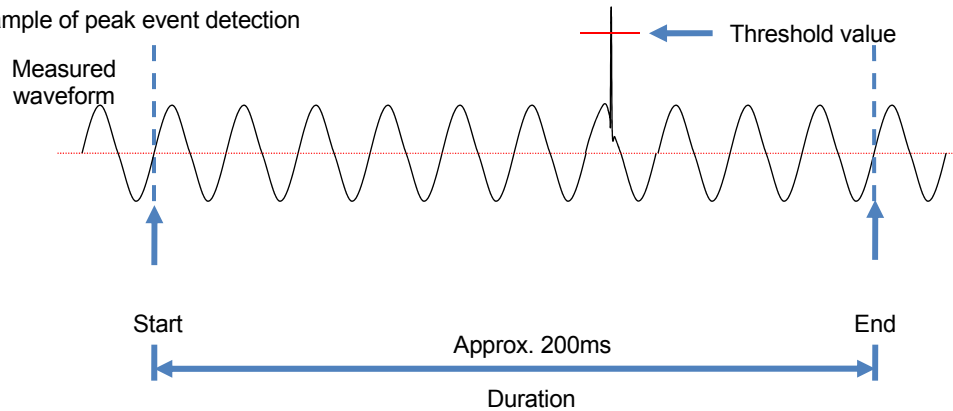





Saved data





When an event occurs, type of the occurred event, ch(system), start/ end time and measured values are recorded.

8. Other functions



Data hold

Display is held anytime by pressing . The LCD shows  to indicate the data hold function is enabled. Another press of  releases the held indication and  disappears. The screens can be switched to check each measured value while the display is being held, and measured values and event information are continuously recorded.

Key lock

Press  2 sec. or longer. The LCD shows  and all keys are disabled. Another press of  2 sec. or longer releases the locked keys and  disappears.

Note

- The  button doesn't work while the key lock function is enabled. To power off the Product, press  2 sec. or longer and turn off .

Backlight Auto-off

While operating with AC power source:

The LCD backlight is turned off automatically 5 min after the last key operation. Press any key except for Power key to turn on the light again. To disable the Backlight auto-off function, press  and go to "Others", "KEW5050 setting", "Backlight" and select "Disable".

While operating with battery:

The backlight is automatically turned off 2 min after the last key operation. Press any key except for the Power Key to turn on the backlight again. The backlight doesn't stay on while the Product is operating with batteries.

Auto-power-off

While operating with AC power source:

The LCD backlight is turned off automatically 5 min after the last key operation. Press any key except for Power key to turn on the light again. To disable the Backlight auto-off function, press  and go to "Others", "KEW5050 setting", "Power" and select "Disable".

While operating with battery:

The backlight is automatically turned off 2 min after the last key operation. Press any key except for the Power key to turn on the backlight again. The backlight doesn't stay on while the Product is operating with batteries.

Auto-ranging

Current range of each sensor is switched automatically according to the measured Trms currents. This auto-ranging function doesn't work at event recoding. A range shifts to one upper range when the input exceeds 300%peak of each range and shifts to one lower range when the input drops under 100% Trms of each range.

Sensor detection

Press  to go to "Basic" tab, and move the highlight to "Detect" under [Clamp] to detect the connected clamp sensors automatically. The Product automatically detects the connected sensors when it gets started and notifies only when the connected sensors are different from the ones used in the previous test.

Print screen

Press  to save the currently displayed screen as a BMP (bitmap) file. * File size: approx. 77KB

Retaining settings

All the settings have been saved and kept in the Product and not be cleared on the time of power-off. The product adopts the same settings used at the previous test when powering on again. * Default values will be displayed for the first time after purchase.

Status indicator

The green LED blinks while the Product is in stand-by mode and stays on during recording.

9. Device connection

9.1 Data transfer to PC

Data in the SD card can be transferred to PC via USB or SD card reader. (supporting USB mass storage) KEW5050 is connected as a removable disk.

Notes:

- The PC doesn't recognize the SD card in the Product during a recording to prevent the measurement data.
- The Product isn't compatible with all kinds of devices. The Product may not work properly if it is connected to a PC via a USB hub.
- Installing the supplied USB driver is essential even when using USB mass storage mode.

* It is recommended to use SD card to transfer data to PC. (Transfer time: approx. 320MB/ hour) It takes longer time to transfer large data by use of SD card since transferring large data files by USB requires more time than using the SD card reader. As to the manipulation of SD cards, please refer to the instruction manual attached to the card. Ensure that the SD card contains only the data files measured with the Product to save data properly.

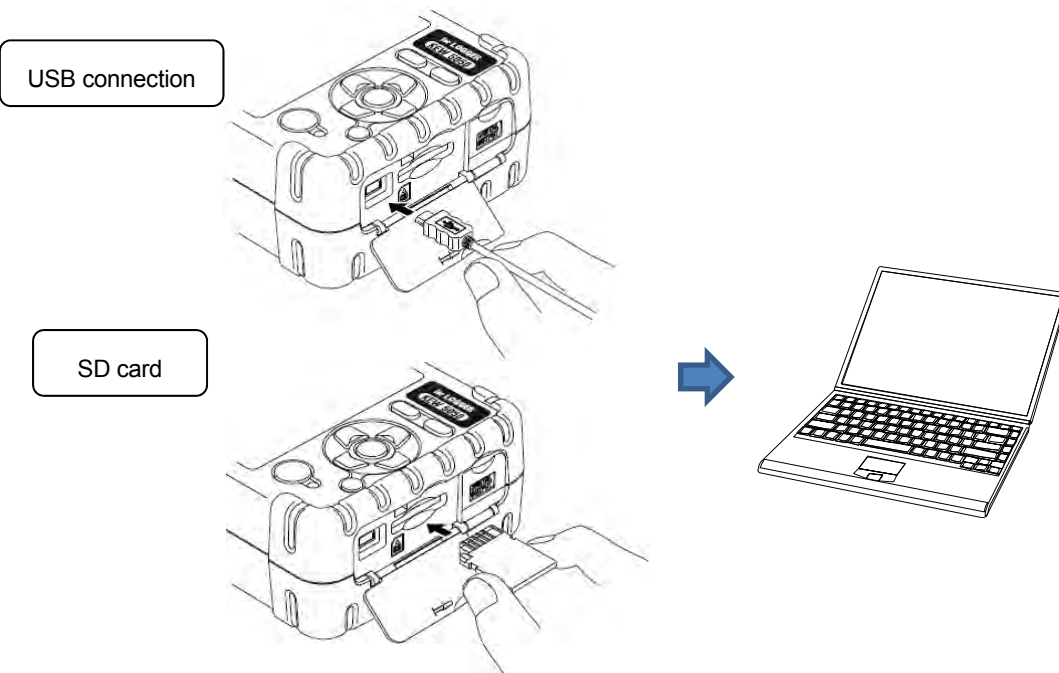

9.2 Signal control

Connection to output terminal

⚠ DANGER

- The digital output terminal L is earthed via earth cable where the Product is earthed with the earth cable; therefore, **voltage applied to the digital output terminal L should be equal to earth voltage**. It may damage the Product or cause serious electrical accident. **Max rated voltage to ground for digital output terminal H is 30 V, 50 mA, 200 mW or less.**

Connectable wire size

Suitable wire : single-wire $\Phi 1.2$ (AWG16), twisted wire 1.25mm^2 (AWG16), strand size $\Phi 0.18\text{mm}$ or more

Usable wire : single-wire $\Phi 0.4 - 1.2$ (AWG26 - 16), twisted wire $0.2 - 1.25\text{mm}^2$ (AWG24 - 16), strand size $\Phi 0.18\text{mm}$ or more

Standard length of bare wire: 11mm

- 1 Open the Connector cover.
- 2 Press the rectangular protrusion above a terminal with a flat-blade screw driver, and insert a signal wire.
- 3 Remove the driver and fix the wire.

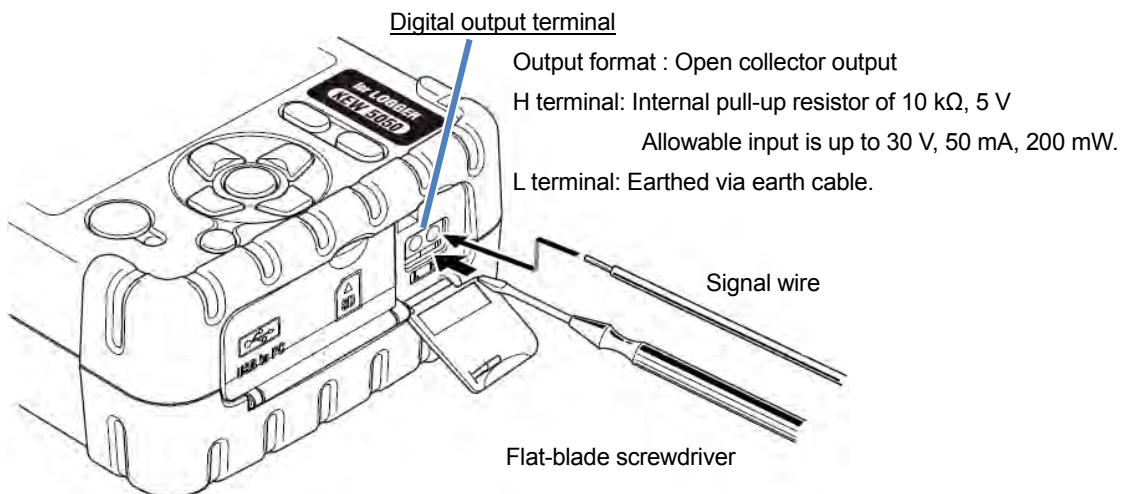

Digital output terminal

The circuit of H and L terminal is open collector output type as illustrated to the left. The L terminal is earthed via the earth cable; the H terminal has a pull-up resistor of $10\text{ k}\Omega$ to control voltage to 5 V for a connection with external device.

The output of H terminal is usually 5 V . The H terminal is connected to L terminal while events are lasting; that is, voltage across the terminals is 0 V . If the duration of an event is less than 1 sec. , voltage across the terminals will be 0 for 1 sec. The same situation occurs when multiple events occur and overlap at the same time. To limit the target events, please refer to: 6.3 Event setting (P. 45) and set "OFF" to the unnecessary events.

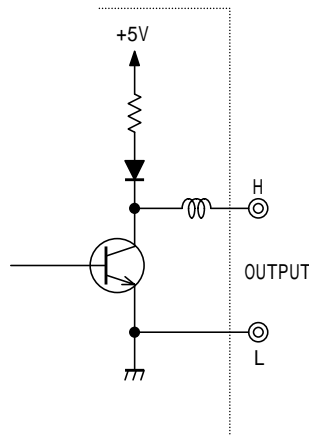

9.3 Getting power from measured line

When it is difficult to use an AC adapter to get power from an outlet, use MODEL8329 (power adapter) instead to derive power through voltage test leads.

⚠ DANGER

- The power adapter, test lead and the Product belong to different measurement categories respectively. The power adapter is rated to the lowest category; do not connect to a circuit on which earth voltage exceeding 150 V AC in CAT III or 240 V in CAT II exists.
- MODEL 8329 Power adapter is rated to 50 Hz/ 60 Hz.
- Connect voltage test lead to the Product first, and only then connect it to the measurement line.
- Never disconnect the voltage test lead from the connector of the Product during a measurement (while the Product is energized).
- Connect to the downstream side of a circuit breaker since a current capacity at the upstream side is large.

⚠ WARNING

- Never attempt to make measurement if any abnormal conditions are noted, such as a broken cover and exposed metal parts.
- Power off the Product before connecting the adapter and test leads.
- Firmly connect voltage test leads to the Product first.

Follow the procedures below to connect the adapter.

- 1 Ensure that KEW5050 and MODEL8329 are both powered off.
- 2 Connect voltage test leads to power input terminals (N/ L) on MODEL8329, and then the plugs of MODEL8329 to the reference voltage input terminals on KEW5050.
- 3 Firmly connect the power plug of MODEL8329 to AC adapter.
- 4 Connect the output terminal of AC adapter to the female connector of earth cable.
- 5 Firmly connect the connection terminal of the earth cable to the AC adapter connector on the Product.
- 6 Connect the clip of earth cable to **well-known earth terminal**.

⚠ DANGER: Always check so as not to connecting the clip other than earth terminal. Never connect to a live wire.

- 7 Connect the alligator clip of voltage test lead to the circuit under test.
- 8 Power on KEW5050.
- 9 Power on MODEL8329.

Reversed procedure is applied to remove the Adapter from the Product. Read through MODEL8329 instruction manual as well.

MODEL8329

Measurement category: CAT III 150 V CAT II 240 V (50/ 60 Hz)
Fuse rating: 500 mA / 600 V AC, Fast acting type Ø 6.3 × 32 mm

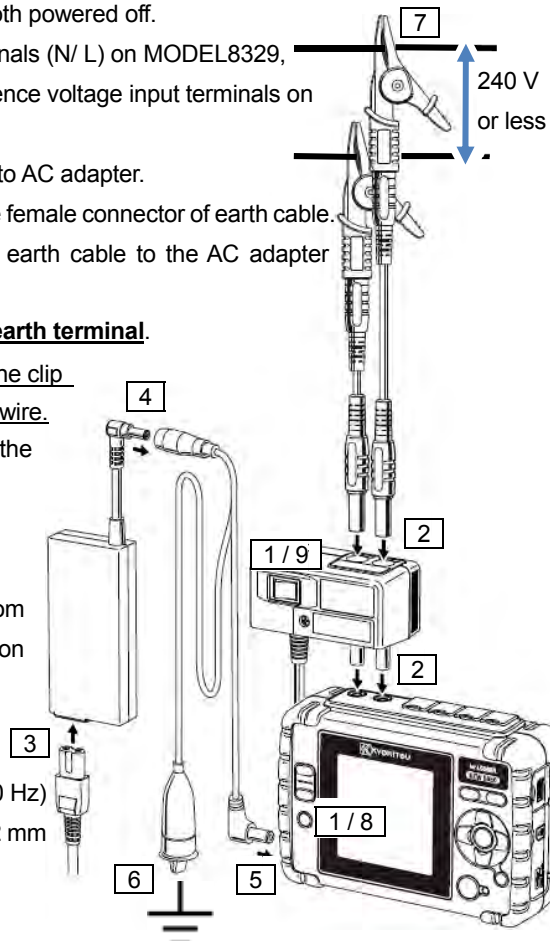

10. PC software for setting and data analysis

The special software “KEW Windows for KEW5050” allows data analysis* and the setup of KEW5050 on a PC.

* Automatic generation of graphs and lists based on the recorded data by just one click. Data management of different settings for multiple KEW5050 units and recorded data.

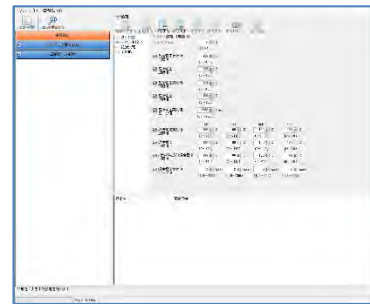
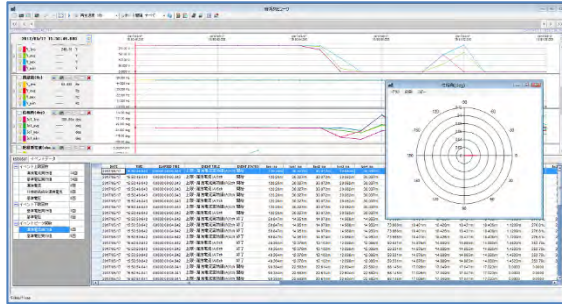

Please refer to the installation manual for “KEW Windows for KEW5050” and install the application and USB driver in your PC.

- Interface

Communication method: USB Ver2.0

USB communication using a special software “KEW Windows for KEW5050” allows:

- * Downloading files downloading files in the SD card to a PC,
- * Making settings for the Product via a PC,
- * Displaying the measured results on a PC in graphic form

- System Requirements

·OS(Operation System)

For the supported OS, please check the version label on the CD case or visit our website.

·Display

1024 × 768 dots, 65536 colors or more

·HDD (Hard-disk space required)

1Gbyte or more (including Framework)

·.NET Framework 3.5

·.NET Framework 4.6

- Trademark

·Windows® is a registered trademark of Microsoft in the United States.



The latest software is available for download from our homepage.

<http://www.kew-ltd.co.jp>

11. Specifications

11.1 Safety requirements

Location for use	: In door use, Altitude up to 2000m
Temp. & Hum. range (guaranteed accuracy)	: 23°C±5°C, Relative humidity 85% or less (no condensation)
Operating Temp. & Hum. range	: -10°C to 50 °C, Relative humidity 85% or less (no condensation)
Storage Temp. & Hum. range	: -20°C to 60°C, Relative humidity 85% or less (no condensation)
Withstand voltage	:
5160 V AC/ 5 sec.	Between Reference voltage input terminal and Enclosure
3310 V AC/ 5 sec.	Between Reference voltage input terminal and Current input terminal, Connector for AC adapter, Communication (USB) connector.
Insulation resistance	: 50 MΩ or more/ 1000 V, between Voltage/ Current input terminal, Connector for AC adapter and Enclosure
Applicable standards	: IEC 61010-1, -2-030 Measurement category Main unit: CAT IV 300 V CAT III 600 V, Pollution degree 2 Voltage test leads: CAT IV 600 V CAT III 1 kV, Pollution degree 2 IEC 61010-031, IEC61326 Class A
Dust/ water-proof	: IEC 60529 IP40

11.2 General specification

LCD	: 160 × 160 dots, FSTN monochrome display
Display update	: 500 ms*
* There is time lag in display update (400 ms max) due to arithmetic processing; however, no time lag between the recorded data and the time stamp.	
Backlight	OFF: Automatically turns off in 2 min (when working with battery)/ in 5 min (working with AC power) after the last key operation. ON: Turn on by pressing any key other than power key.
Dimension	: 165(L) × 115(W) × 57(D) mm
Weight	: approx. 680g (including batteries)
Accuracy	: within ±5 sec/ day
Power source	: MODEL8262 AC adapter

Voltage range	100 V AC – 240 V AC
Frequency	50 Hz/ 60 Hz (Allowable range: 47 Hz – 63 Hz)
Power consumption	7.5 VA max

: DC power source

	Dry cell battery	Rechargeable battery
Voltage	4.5 V DC (1.5V×3 in series × 2 in parallel)	3.6 V DC (1.2V×3 in series × 2 in parallel)
Battery	Size AA Alkaline (LR6)	Size AA Ni-MH (1900mA/h)
Current consumption	0.21 A typ. (@4.5 V)	0.26 A typ. (@3.6 V)
Battery life *ref. value at 23°C	11 hours	9 hours * with fully charged batteries

Accessories :	MODEL7273 voltage test lead (CAT III 1 kV, CAT IV600 V, with red&black alligator clip)	1 set
	Cable marker - 4 colors x 2 pcs each (red, yellow, blue, green).....	8 pcs
	MODEL8262 AC adapter	1 pce
	MODEL7170 Power cord	1 pce
	MODEL7278 Earth cable	1 pce
	MODEL7219 USB cable	1 pce
	Instruction manual	1 pce
	Installation manual.....	1 pce
	CD-ROM	1 pce
	KEW Windows for KEW5050 (Data analysis & configuration software)	
	Instruction manual (PDF file)	
	Alkaline size AA battery (LR6)	6 pcs
	SD card (2GB).....	1 pce
	MODEL9125 Carrying bag	1 pce

Optional accessories:

Clamp sensor	MODEL8177 (for leakage clamp sensor	10 A type	Ø40mm)	
	MODEL8178 (for leakage clamp sensor	10 A type	Ø68mm)	
	MODEL8146 (Leakage clamp sensor	10 A type	Ø24mm)	
	MODEL8147 (Leakage clamp sensor	10 A type	Ø40mm)	
	MODEL8148 (Leakage clamp sensor	10 A type	Ø68mm)	
	MODEL8141 (Leakage clamp sensor	1 A type	Ø24mm)	
	MODEL8142 (Leakage clamp sensor	1 A type	Ø40mm)	
	MODEL8143 (Leakage clamp sensor	1 A type	Ø68mm)	
	MODEL8128 (Clamp sensor	50 A type	Ø24mm)	
	MODEL8127 (Clamp sensor	100 A type	Ø24mm)	
	MODEL8121 (Clamp sensor	100 A type	Ø24mm)	
	MODEL8126 (Clamp sensor	200 A type	Ø40mm)	
	MODEL8125 (Clamp sensor	500 A type	Ø40mm)	
	MODEL8122 (Clamp sensor	500 A type	Ø40mm)	
	MODEL8123 (Clamp sensor	1000 A type	Ø55mm)	
	MODEL8124 (Clamp sensor	1000 A type	Ø68mm)	
	MODEL8130 (Flexible sensor	1000 A type	Ø110mm)	
	MODEL8129 (Flexible sensor	3000 A type	Ø150mm)	
		MODEL8329 Power adapter (CAT III 150 V, CAT II 240 V)		

Real-time OS:

This Product uses the source code of T-Kernel under T-License granted by the T-Engine Forum (www.t-engine.org) Portions of this software are copyright © 2010 The FreeType Project (www.freetype.org). All rights reserved.

External communication: via USB * USB cable length should be 2m or less.

Connector	mini-B
Communication method	USB Ver2.0
USB identification no.	Vendor ID: 12EC (Hex), Product ID: 5050 (Hex), Serial no.: 0+7-digit individual no.
Communication speed	12Mbps (full-speed)

Digital output terminal:

The circuit of H and L terminal is open collector output type. The L terminal is earthed via the earth cable; the H terminal has a pull-up resistor of 10 kΩ to control voltage to 5 V for a connection with external device. The H terminal is connected to L terminal while events are lasting; that is, voltage across terminals is 0 V. If the duration of an event is less than 1 sec., voltage across terminals will be 0 for 1 sec. The same situation occurs when multiple events occur and overlap at the same time.

Connector	Through hole Screwless terminal block, 2-pole (ML800-S1H-2P)
Output format	Open collector output, 0 V between terminal H and L, active
Input voltage	0 – 30 V, 50 mA max, 200 mWmax
Voltage across terminals	While detecting events: 0 V – 1 V Stand-by mode: 4 V – 5 V (inside pull-up resistor 10 kΩ, 5 V)
Rated input	H terminal Max. voltage-to-ground: 30 V, 50 mA, 200 mW L terminal * Earthed via earth cable.

11.3 Measurement specification

Frequency f [Hz]

Measurement method : Reciprocal method; calculating reciprocal numbers of accumulated counts in 10-cycle (50 Hz)/ 12-cycle (12-cycle).

Displayed digit	3-digit
Accuracy	±2dgt *where reference voltage is sine wave 40 - 70Hz and 10 V Trms or higher.
Display area	10.0 - 99.9 Hz (Bar (“----”) indication outside of this range)
Signal source	Reference voltage

Measurement item and the number of analysis points

Computed with 8192-point data while regarding 200ms(50Hz:10-cycle, 60Hz:12-cycle) as one measurement area.
Trms leakage current (Iom), Trms reference voltage (Vm)
Computed with 4096-point data while regarding 200ms(50Hz:10-cycle, 60Hz:12-cycle) as one measurement area.
Leakage current (Io), Reference voltage (V), Resistive leakage current (Ior), Phase angle (θ), Insulation resistance (R)
Measured in 40.96ksps (every 24.4μs).
Instantaneous peak leakage current (IomP), Instantaneous peak reference voltage (VmP)

Instantaneous events to be measured

Measurement method :40.96ksps (every 24.4µs), gapless, calculate Trms values every 200ms.

Effective frequency range : 40 – 70 Hz

Trms leakage current (Leakage clamp sensor)

Trms load current (Load current clamp sensor)

I_{om} [A Trms]

Range	Leakage clamp sensor		
	8177/8178	(10A type)	: 10.000/100.00/1000.0m/10.000A/AUTO
	8146/8147/8148	(10A type)	: 10.000/100.00/1000.0m/10.000A/AUTO
	8141/8142/8143	(1A type)	: 5.000/50.00/500.0m/1.000A/AUTO
	Load current clamp sensor		
	8128	(50A type)	: 500.0m/5.000A/50.00A/AUTO
	8121/8127	(100A type)	: 1000m/10.00/100.0A/AUTO
	8126	(200A type)	: 2.000/20.00/200.0A/AUTO
	8122/8125	(500A type)	: 5.000/50.00/500.0A/AUTO
	8123/8124/8130	(1000A type)	: 10.00/100.0/1000A/AUTO
8129	(3000A type)	: 300.0/1000/3000A	
Display digit	Leakage clamp sensor	: 5-digit	
	Load current clamp sensor	: 4-digit	
Effective input range	1% - 110% (Trms) of each range, and 200% (peak) of the range		
Display range	0.15% - 130% (display "0" for less than 0.15%, "OL" if the range is exceeded)		
Crest factor	3 or less		
Accuracy	±0.2%rdg±0.2%f.s. + clamp sensor amplitude accuracy * for waveforms of sine wave 40 – 70 Hz		
Input impedance	Approx. 1 MΩ		
Equation ^{*1}	$I_{om} = \sqrt{\left(\frac{1}{n} \left(\sum_{i=0}^{n-1} (I_{oi})^2\right)\right)}$		

Trms reference voltage V_m [V Trms]

Range	1000.0V
Display digit	5-digit
Effective input range	10 – 1000 V Trms, and 2000 V _{peak}
Display range	0.9 V - 1100.0 V Trms (display "0" for less than 0.9 V, "OL" if the range is exceeded)
Crest factor	2 or less
Accuracy	±0.2%rdg±0.2%f.s. * for waveforms of sine wave 40 – 70 Hz
Input impedance	Approx. 4 MΩ
Equation ^{*1}	$V_m = \sqrt{\left(\frac{1}{n} \left(\sum_{i=0}^{n-1} (V_i)^2\right)\right)}$

*1 V: Reference voltage, I_o: Leakage current, i: Sampling point no., n: Approx. 8192 points

Items to be calculated

Measurement system	: Digital PLL synchronization
Measurement method	: Calculation with a basic wave after harmonics analysis
Effective frequency range	: 40 - 70Hz
Window width	: 10-cycle at 50Hz, 12-cycle at 60Hz
Window type	: Rectangular
Data analysis	: 4096 points
Analyzing rate	: Once/ 200ms at 50Hz/60Hz, gapless

TRMS Leakage current, basic wave (Leakage clamp sensor)

TRMS Load current, basic wave (Load current clamp sensor)

I_o [Trms]

Range	The same as Trms leakage/ load current
Display digit	The same as Trms leakage/ load current
Effective input range	The same as Trms leakage/ load current
Display range	The same as Trms leakage/ load current
Meas. method	Analysis window width is 10/12-cycle against 50/60Hz, measurement values are calculated by basic wave only.
Accuracy	$\pm 0.2\%rdg \pm 0.2\%f.s.$ + clamp sensor amplitude accuracy * for reference voltages with sine wave 40 – 70 Hz and 90 V Trms or higher
Equation ^{2,3}	$I_{oc} = \sqrt{(I_o(10k)_r)^2 + (I_o(10k)_i)^2}$

Reference voltage V [Trms]

Range	The same as Trms reference voltage
Display digit	The same as Trms reference voltage
Effective input range	The same as Trms reference voltage
Display range	The same as Trms reference voltage
Meas. method	Analysis window width is 10/12-cycle against 50/60Hz, measurement values are calculated by basic wave only.
Accuracy	The same as Trms reference voltage
Equation ^{2,3}	$V = \sqrt{(V(10k)_r)^2 + (V(10k)_i)^2}$

Phase difference of reference voltage, current θ [deg]

Display digit	4-digit
Display range	0.0° to $\pm 180.0^\circ$ (regarding the phase of reference voltage as 0.0°) Leading: 0 to +180°, lagging: 0 to -180°
Meas. method	Analysis window width is 10/12-cycle against 50/60Hz, measurement values are calculated by basic wave only.
Accuracy	Within $\pm 0.5^\circ$ for the inputs of 10% or higher of leakage current range, sine wave 40 - 70 Hz, reference voltage of 90 V Trms or higher, Within $\pm 1.0^\circ$ when using lor leakage clamp sensor, and Within $\pm 0.5^\circ$ + clamp sensor accuracy when using general purpose clamp sensor.
Equation ³	$\theta = \theta I_o - \theta V \quad \theta V = \tan^{-1} \left\{ \frac{V_r}{-V_i} \right\} \quad \theta I_o = \tan^{-1} \left\{ \frac{I_{or}}{-I_{oi}} \right\}$

Resistive leakage current Ior [A Trms]

Range	The same as Trms leakage/ load current
Display digit	The same as Trms leakage/ load current
Effective input range	The same as Trms leakage/ load current
Display range	The same as Trms leakage/ load current * not displayed when using load current clamp sensors.
Meas. method	Analysis window width is 10/12-cycle against 50/60Hz, measurement values are calculated by basic wave only.
Accuracy	<p>For reference voltages of sine wave 40 – 70 Hz and 90 V Trms or higher, $\pm 0.2\% \text{rdg} \pm 0.2\% \text{f.s.} + \text{clamp sensor amplitude accuracy} + \text{error of phase accuracy}^*$ (phase error)</p> <p>* add $\pm 2.0\% \text{rdg}$ to measured I_o value when using I_{or} leakage clamp sensor. (θ: within the accuracy of reference voltage/ current phase difference $\pm 1.0^\circ$)</p> <p><u>Calculation example:</u> When using KEW8178 and measuring I_{or} = 1mA, I_o=5mA on 10mA range; $\pm 0.2\% \text{rdg} \pm 0.2\% \text{f.s.} \pm 1.0\% \text{rdg}$ (amplitude accuracy of KEW8178) $+ I_o \pm 2.0\% \text{rdg}$ (clamp sensor phase error: $\pm 1.0^\circ$) $= 1 \text{mA (I}_{or}) \times \pm 0.2\% + 10 \text{mA (I}_{or \text{ f.s.}}) \times \pm 0.2\% + 1 \text{mA (I}_{or}) \times \pm 1.0\% + 5 \text{mA (I}_o) \times \pm 2.0\%$ $= \pm 0.002 \text{mA} \pm 0.02 \text{mA} \pm 0.01 \text{mA} \pm 0.1 \text{mA}$ $= \pm 0.132 \text{mA}$ $\pm 0.132 \text{mA} / 1 \text{mA (I}_{or}) = \pm 0.132$; therefore, I_{or} accuracy against 1 mA is $\pm 13.2\% \text{rdg}$.</p>
Equation ^{2,3}	
1P2W 1P3W	$I_{or} = \frac{ V_{(10k)_r} \times I_{o(10k)_r} + V_{(10k)_i} \times I_{o(10k)_i} }{V}$
3P3W	$I_{or} = \frac{2\sqrt{3}}{3} \times \frac{ V_{(10k)_r} \times I_{o(10k)_i} - V_{(10k)_i} \times I_{o(10k)_r} }{V}$
3P4W	Sum of balanced static capacitive leakage current (I _{oc}) is zero. $I_{oc} = I_{oc_L1} + I_{oc_L2} + I_{oc_L3} = 0$ $\therefore I_{or} = I_o$

Insulation resistance R [ohm]

Range	20.00MΩ
Display digit	4-digit
Display range	* not displayed when using load current clamp sensors. 0.15% - 130% of the range ("0" is displayed if less than 0.15%, "OL" if the range is exceeded.) Bar ("----") is displayed where reference voltage/ leakage current is "0" or "OL".
Equation ²	$R = \frac{V}{I_{or}}$

² V: Reference voltage, I_o: Leakage current

³ k=1: 1st order of harmonic wave (basic wave) r: real number component after FFT,

i: imaginary number component after FFT

Measurement cycle in the equation is 10-cycle; replace "10k" with "12k" if a measurement cycle is 12.

Event items

Upper limit of Trms values H: Iom / H: Io / H: Ior[A Trms] / H: Vm / H: V[V Trms]

Lower limit of Trms values L: VmL/ L: V[V Trms]

Meas. method	The same as each measurement item
Range	The same as each measurement item
Display digit	The same as each measurement item
Effective input range	The same as each measurement item
Display range	The same as each measurement item
Crest factor	The same as each measurement item
Accuracy	The same as each measurement item
Input impedance	The same as each measurement item

Instantaneous peak leakage current Pk:Iom[A peak]

Meas. method	Check and detect event occurrence in approx. 40.96ksps (every 24.4 μ s), gapless
Range	The same as Trms leakage/ load current
Display digit	The same as Trms leakage/ load current
Effective input range	0.15% of each range (1mA \leq) - 200% (peak)
Display range	0.15% of each range (1mA \leq) - 200% (peak)
Accuracy	Based on 100% (DC) of each range. x 1/ 10/ 100 ranges : $\pm 0.5\%$ f.s. + clamp sensor amplitude accuracy x 1000 range : $\pm 5.0\%$ f.s. + clamp sensor amplitude accuracy * In case of Ior leakage clamp sensor, x 1: 10A / x 10: 1000mA/ x 100: 100mA/ x 1000: 10mA
Input impedance	Approx. 1 M Ω
Threshold value	Specify the peak current in absolute value.

Instantaneous peak reference voltage Pk:Vm[V peak]

Meas. method	Check and detect event occurrence in approx. 40.96ksps (every 24.4 μ s), gapless
Range	The same as Trms reference voltage
Display digit	The same as Trms reference voltage
Effective input range	50 V – 2000 V (peak)
Display range	50 V – 2000 V (peak)
Accuracy	$\pm 0.5\%$ f.s. *based on 1000V DC
Input impedance	Approx. 4 M Ω
Threshold value	Specify the peak voltage in absolute value.

12. Troubleshooting

12.1 General troubleshooting

When any defect or failure of the Product is suspected, check the following points first. If your problem is not listed in this section, contact your local Kyoritsu distributor.

Symptom	Check
Cannot power on the Product. (Nothing is displayed on the LCD.)	<p><u>When operating with an AC power supply:</u></p> <ul style="list-style-type: none"> • Power cord is firmly connected to an outlet? • Output terminal of AC adapter and earth cable is properly connected to the Product? • No break in Power cord, AC adapter output cable or earth cable? • Supply voltage is within the allowable range? <p><u>When operating with batteries:</u></p> <ul style="list-style-type: none"> • Batteries are installed with observing correct polarity? • Fully-charged size AA Ni-HM batteries are installed?, or • Size AA Alkaline batteries are not exhausted? <p><u>If the problem not solved yet:</u></p> <ul style="list-style-type: none"> • Disconnect the AC adapter and remove all batteries from the Product. Insert the batteries again and connect the AC adapter, and power on the Product. If the Product still does not turn on, failure of the Product itself may be suspected.
Cannot power off the Product.	<ul style="list-style-type: none"> • Key lock function is turned off? • When the display update doesn't work, disconnect the AC adapter and remove all batteries. Connect the adapter and install batteries again, and power on the Product. If the Product still doesn't work properly, failure of the Product itself may be suspected.
Any key doesn't work.	<ul style="list-style-type: none"> • Key lock function is turned off? • Check the effective keys on each range.
The LCD doesn't indicate "0" at the time of no load.	<ul style="list-style-type: none"> • Some digits may be displayed while; <ul style="list-style-type: none"> - reference input voltage terminals are open, - no sensors are connected to current input terminals, or - clamp sensors are connected to the Product, but not clamping onto a measured conductor. <p>In any of above cases, there's no influence on measurements.</p>

Symptom	Check
LCD doesn't show the measured values. Readings are unstable or inaccurate.	<ul style="list-style-type: none"> ● Voltage test leads are connected properly? Connecting the voltage test leads are required, even when measuring current only, to get stable readings. ● The orientation of clamp sensor is correct? ● The Product needs to be earthed when using AC adapter. Properly earth the Product with the supplied earth cable. ● Frequency of the reference voltage is within the allowable range: 40 – 70 Hz? ● Setting of the Product and the selected wiring configuration are appropriate for the measured line? ● The sensor setting is harmonized with the sensor in use? Manual configuration is required for general purpose clamp sensor. ● No break in voltage test leads or failure of clamp sensor? ● Noise interference on input signal? ● Strong electric magnetic field does not exist in proximity? ● Measurement environment meets the specification of the Product?
Cannot save data on the SD card, or read the saved data in the card.	<ul style="list-style-type: none"> ● SD card is inserted correctly? ● SD card supplied with the Product or supplied as optional parts is used? Proper operation is not guaranteed if any other card is used. ● SD card has been formatted on the Product? Formatting on any other devices may reduce space or make the data unreadable. ● Is there available free space in a SD card? ● Verify the proper operation of SD card on other well-known hardware.
Cannot download data or make settings via USB communication.	<ul style="list-style-type: none"> ● PC and the Product is properly connected with the supplied USB cable? ● Run the communication application software “KEW Windows for KEW5050” and check the connected devices are displayed or not. If no device is displayed, USB driver might not be installed correctly. Please refer to the installation manual for “KEW Windows for KEW5050” and re-install the USB driver.
SD card is not detected by PC. (USB connection)	<ul style="list-style-type: none"> ● The SD card in the Product isn't detected by the PC during a recording in order to protect the measured data. ● USB driver might not be installed correctly. Please refer to the installation manual for “KEW Windows for KEW5050” and re-install the USB driver.

12.2 Input and display items

Input and display items vary depending on the setting.

	Check
Cannot enter/ delete serial no.	<ul style="list-style-type: none"> • These functions are available with general leakage clamp sensor only. Refer to “Serial No.” (P. 44) in this manual.
Cannot set event detection to “ON”.	<ul style="list-style-type: none"> • Current range for clamp sensor is set to other than “AUTO”? When “AUTO” is set, event detection is automatically set to off on the CH. Select a fixed range, event threshold is included, to enable event detection and set “ON” to event detection. For further detail, see “Upper threshold value (H)/ ch” (P. 46) and “Peak threshold value (Pk)/ch” (P. 50) for detail.

12.3 Error messages and actions

Error message may appear on the LCD while using the Product. Please check the following table, if any error message appears, and take actions.

Message	Detail & Action
Cannot start recording. Please check the SD card.	<ul style="list-style-type: none"> • Confirm that the SD card is inserted correctly. • If any problem on the SD card is suspected, please refer to: “12.1 General troubleshooting” (P. 89) – “Cannot save data on the SD card, or read the saved data in the card.”
Cannot save data. Check the SD card.	
No SD cards.	
Out of SD card space. Recording will be stopped.	<ul style="list-style-type: none"> • Backup the files to a PC and delete them or format the card, or use another SD card formatted on the Product only after stop recording and confirm the message “Recording stopped.” disappears. See “Recorded data” (P.57) for detail.
Not having free space on the SD card. Format the card or delete unnecessary files.	<ul style="list-style-type: none"> • Check the free space on the SD card. If the space is not enough, backup and delete the files or format the card, or use another card. The SD card should be formatted on KEW5050, not on the PC. See “Saved data” (P.57).

Message	Detail & Action
<p>Connected sensor doesn't match the settings on the unit. Check the connection.</p>	<ul style="list-style-type: none"> • The connected clamp sensor(s) differs from the one(s) used during the previous test. • KEW5050 automatically identify lor clamp sensor only. Manual setting is required to use general purpose leakage clamp sensor. Make settings from: SET UP, "Basic tab", [Clamp]. • Confirm that current clamp sensor(s) is(are) firmly connected to. • If any failure is in doubt: Disconnect the sensor, for which "NG" is given and connect to the CH on which another sensor is properly detected. If the result "NG" is given for the same CH, a defect of the Product is suspected. A defect of sensor itself is suspected if "NG" is given for the same sensor. Stop using the Product and the sensor, if any defects are in doubt.
<p>The connected sensor differs from previous one. Check settings.</p>	
<p>Sensor connection is incorrect. Check the connection.</p>	
<p>Start time is set in the past. Check the recording start method.</p>	<ul style="list-style-type: none"> • REC Start is set to either "Constant." or "Time period." and the time set for "REC End" is set to the past. Check and modify the time and date. See "Recording setting" (P.53).
<p>Cannot change instrument settings during recording or in stand-by mode.</p>	<ul style="list-style-type: none"> • Setting change is not allowed during a recording. To change the settings, stop recording and confirm "Recording stopped." message appears and then disappears.
<p>Event detection is disabled on AUTO range.</p>	<ul style="list-style-type: none"> • When "AUTO" is set to A range for clamp sensor, event detection on the subjected CH is automatically set to "OFF". Select a fixed range, event threshold value is included, to enable event detection function.