

nanodac™ Recorder / Controller

User Guide

HA030554 Issue 16

Date: September 2021



Eurotherm®

by **Schneider** Electric

Table of Contents

Table of Contents	3
Safety Information	11
Important Information	11
Safety and EMC	12
Symbols	16
Hazardous Substances	16
USB Device Precautions	16
32-BIT Resolution	16
Cybersecurity	17
What's in this Chapter	17
Introduction	17
Secure Network Topologies and Good Practices	17
Security Features	17
Principle of Secure by Default	17
HMI Access Level / Comms Config Mode	17
Logged Out Access Level	17
Operator Access Level	18
Customizable Users	18
Supervisor Access Level	19
Engineer Access Level	19
HMI Passwords	19
Ethernet security features	20
Ethernet rate protection	20
Broadcast Storm protection	20
Configuration backup and recovery	20
Memory Integrity	20
Firmware	20
Supported Protocols and Threat Mitigations	22
FTP Client	22
FTP Server	22
ICMP (ping)	22
DHCP	22
SNTP	22
ModBus	23
HTTP (Web Server)	23
UHH Navigator	23
Ethernet IP	23
BACnet	23
Decommissioning	23
Legal Information	24
Introduction	25
Unpacking the Instrument	25
Installation	26
Mechanical Installation	26
Installation Procedure	26
Demounting	27
Removing the Instrument from its Sleeve	27
Electrical Installation	30
Installation Requirements	31
Termination details	31
Low Voltage Option	31
Dual Input Option	31

Sensor Break Detection	32
Dual Milliamp Offset Correction	32
Input Range Limitation	32
Modbus Master communications	32
EtherNet/IP	32
Operation	33
Introduction - Initial Setup	33
Operator Interface	34
Display Screen	34
Navigation Pushbuttons	35
On Screen Help	36
Process Variable Display	36
Alarm Icons	37
Status Bar Icons	38
Breaks in recording	41
Top Level Menu	41
Home	41
Configuration	42
User menu	42
Go to View	43
History	46
Faceplate Cycling on/off	46
Operator Notes	46
Demand Archiving	46
Login	49
Display Modes	52
Vertical Trend Mode	52
Horizontal Trend Mode	53
Vertical Bargraph Mode	54
Horizontal Bargraph Mode	54
Numeric Mode	55
Alarm Panel Mode	56
Control Loop1/Loop2	57
Cascade Display Mode	58
Programmer Display Mode	59
Steriliser Display Mode	70
Batch Summary	75
Batch Control	76
Promote list	77
Modbus Master display mode	78
EtherNet/IP display mode	80
Trend History	87
Navigation	88
History Options Menu	89
Text Entry	89
Numeric keyboard	90
USB keyboard	90
Configuration	91
Instrument Menu	92
Clock	92
Locale	93
Display configuration	94
Info menu	96
Upgrade	97
Security menu	98
I/O fitted	101
Save/Restore	102
Input adjust	103
Output adjust	106
User Accounts (Auditor)	107

Interface	110
Archiving	111
FTP Server	114
Modbus TCP	115
BACnet.....	116
Group Configuration.....	117
Group Trend configuration	117
Group Recording configuration	117
Batch Configuration.....	119
Initiating a new Batch.....	122
Starting a Batch	122
Starting a Batch using Modbus	123
Input Channel Configuration	123
Channel Main.....	123
Channel Trend configuration.....	127
Alarm 1 menu.....	128
Alarm 2 menu.....	131
Alarm types	131
Virtual Channel Configuration	133
Maths channel configuration.....	133
Totaliser configuration	135
Wiring Example using a counter in combination with a totaliser	140
Counter configuration.....	141
Loop Option Configuration	142
Main menu parameters.....	143
Setup menu parameters	144
Tune menu parameters.....	145
PID menu parameters.....	145
Setpoint menu parameters.....	147
Output menu items.....	148
Loop diagnostics	150
Advanced Loop Configuration.....	152
Advanced Loop Main menu	153
Advanced Loop Setup menu.....	154
Advanced Loop Tune menu	155
Advanced Loop Master PID menu	158
Advanced Loop Slave PID menu	159
Advanced Loop Master SP menu	162
Advanced Loop Slave SP menu	163
Cascade Full Scale Mode	165
Cascade Trim Mode.....	166
Advanced Loop Output menu	167
Advanced Loop Diagnostics menu	170
Programmer Configuration.....	171
Programmer Features menu.....	172
Programmer FTP menu	174
Programmer Setup menu.....	175
Programmer Run menu	178
Connecting the programmer to a loop	179
Configuration by Modbus Comms.....	181
Modbus Master Configuration	182
Slave Main menu	183
Slave Diagnostics menu	185
Modbus master data configuration.....	186
Ethernet/IP Configuration.....	189
Ethernet/IP Configuration Main menu	190
Implicit inputs/outputs	191
Explicit inputs/outputs	191
Web Server	192
Configuration Display.....	193
Digital I/O	193
Digital input/output	194

Digital inputs	194
Digital outputs	195
DC Output	195
Configuration display	195
User LIN	197
User linearisation table rules	197
Custom Messages	198
Zirconia Block Option	198
Definitions	198
Configuration	199
Zirconia Probe Wiring	203
Steriliser Option	203
Configuration parameters	204
Saturated Steam Option	206
Pressure Units Conversion	208
Saturated Steam Mass Flow Calculation	208
Saturated Steam Heat Flow Calculation	209
Saturated Steam Heat Consumed Calculation	209
Saturated Steam Enthalpy Calculation	210
Mass Flow Option	210
Linear Mass Flow Calculation	210
Root Mass Flow Calculation	211
Configuration	212
Humidity Block Option	213
Configuration parameters	213
BCD Input	214
Input rules	214
Configuration	214
Logic (2 Input) Block	215
Parameters	215
Logic (8 Input) Block	216
Parameters	216
Schematic	217
Invert input decoding table	217
Multiplexer block	218
Configuration parameters	219
Math (2 Input)	220
Parameters	220
Sample and Hold details	222
Timer	222
Parameters	222
Timer modes	223
User Values	225
Parameters	225
Alarm Summary	225
Real Time Event Configuration	226
MODBUS TCP Slave Comms	227
Installation	227
Introduction	227
Function Codes	227
Data types	228
Invalid multiple register writes	228
Master communications timeout	229
Non-volatile parameters in EEPROM	229
Parameter List	232
BACnet	343
BACnet Objects	343
BACnet Services	343
BACnet Object Mapping	343
Mapping to I/O and Loop Data Points	343

Read/Write Access to Internal Modbus Registers	346
Optional parameters	347
BACnet Services	347
Foreign Device Registration	348
BACnet Configuration	348
iTOOLS	349
iTOOLS Connection	349
Ethernet (Modbus TCP) communications	349
Direct Connection	352
Scanning for Instruments	353
Graphical Wiring Editor	354
Tool bar	355
Wiring Editor Operating Details	355
Parameter Explorer	364
Parameter explorer detail	365
Explorer tools	366
Context Menu	366
Watch/Recipe Editor	367
Creating a Watch List	367
Watch Recipe toolbar icons	368
Watch/Recipe Context Menu	369
Programmer Option	369
Segment parameter editing	369
Digital Event display	371
Program parameters	371
Adding and deleting segments	372
Loading and Saving programs	373
Toolbar icons	373
Context menus	374
Programmer menu	375
Two channel programs	375
To Set Up OEM Security	376
User Wiring	381
Drive Relay Example	381
Wire removal	383
Counter Example	383
USB Devices	387
Memory Stick	387
Barcode Reader	387
USB Keyboard	388
Appendix A: Technical Specification	389
Installation Category and Pollution Degree	389
Installation Category II	389
Pollution Degree 2	389
Recorder Specification	389
I/O types	389
Environmental performance	390
Other approvals and compliance details	390
Physical	390
Operator interface	390
Power requirements	390
Battery backup	390
Ethernet communications	390
USB port	391
Update/Archive rates	391
Analogue Input Specification	392
General	392
DC input ranges	392

Thermocouple data	394
Relay and Logic I/O Specification	395
OP1, OP2, OP3, OP4 and OP5 logic input, logic output and relay specification	395
Active (current on) current sourcing logic output	395
Inactive (current off) current sourcing logic output (OP1 or OP2 only).....	395
Active (current on) contact closure sourcing logic input (OP1 and OP2 only)	395
Relay contacts (OP1, OP2 and OP3) - AgCdO	395
Relay contacts (OP4 and OP5) - AgNi.....	395
Digital Inputs	396
DigInA, DigInB, contact closure logic input	396
Contact closure	396
DC Outputs	397
OP1, OP2, OP3 DC analogue outputs.....	397
Current outputs (OP1, OP2 and OP3).....	397
Voltage outputs (OP3 only).....	397
General	397
Blocks Supported	397
‘Toolkit’ Blocks.....	397
Application Blocks.....	397
Appendix B: Control Loops	399
Introduction	399
Example (Heat Only).....	399
Control Loop Definitions.....	400
Auto/Manual.....	400
Types of Control Loop.....	400
On/Off control.....	400
PID Control	401
Motorised valve control	403
Loop Parameters	404
Relative cool gain (R2G).....	404
High and Low cutback	405
Manual Reset.....	405
Integral Hold	406
Integral De-bump	406
Loop Break	406
Gain Scheduling	407
Tuning	408
Introduction	408
Loop Response.....	408
Initial Settings	409
Other tuning considerations.....	410
Autotune	411
Relative Cool Gain in Well Lagged Processes	417
Manual tuning	419
Setpoint.....	421
Setpoint function block.....	421
Setpoint Limits	422
Setpoint Rate Limit	422
Setpoint Tracking.....	423
Manual Tracking	423
Output	423
Introduction	423
Output Limits.....	424
Output Rate Limit.....	425
Sensor Break Mode	425
Forced Output.....	425
Power Feed Forward	426
Cool Type.....	426
Feed forward	427

Valve nudge	429
Time Proportioning.....	430
Diagnostics	430
Appendix C: Reference	431
Battery	431
Setting Up An FTP Server Using Filezilla.....	431
Downloading	431
Server Setup	433
PC Setup.....	435
Recorder/Controller Setup	436
Archive Activity.....	436
Function Block Details.....	437
Eight Input OR Block.....	437
TCP Port Numbers.....	437
Isolation Diagram	438
Appendix D: Web Server	439
Browsers	439
Connecting to the Internet.....	439
Denied Page	439
Error Message	440
Home Page	440
About Page	441
Contact Page	441
Bar Graph Page.....	442
Line Graph Page.....	443
Numeric Page	444
Alarm Summary Page.....	445
Message Summary Page.....	445
Promote Page	446
Historical Line Page	446
Status Icons	447
DHCP Support	448
Network Protocols.....	448
Languages	448
Appendix E: LabVIEW Driver	449
Application Example 1 - Heat/Cool Control.....	450
Application Example 2 - Program Load by Program Number	453
Application Example 3 - Steriliser	454
Application Example 4 - Configurable Steriliser	454
Full driver capabilities list	455

Safety Information

Important Information

Read these instructions carefully and look at the equipment to become familiar with the device before trying to install, operate, service, or maintain it. The following special messages may appear throughout this manual or on the equipment to warn of potential hazards or to call attention to information that clarifies or simplifies a procedure.



The addition of either symbol to a “Danger” or “Warning” safety label indicates that an electrical hazard exists which will result in personal injury if the instructions are not followed.



This is the safety alert symbol. It is used to alert you to potential personal injury hazards. Obey all safety messages that follow this symbol to avoid possible injury or death.

DANGER

DANGER indicates a hazardous situation which, if not avoided, **will result in** death or serious injury.

WARNING

WARNING indicates a hazardous situation which, if not avoided, **could result in** death or serious injury.

CAUTION

CAUTION indicates a hazardous situation which, if not avoided, **could result in** minor or moderate injury.

NOTICE

NOTICE is used to address practices not related to physical injury. The safety alert symbol shall not be used with this signal word.

Note: Electrical equipment must be installed, operated, serviced and maintained only by qualified personnel. No responsibility is assumed by Schneider Electric for any consequences arising out of the use of this material.

Note: A qualified person is one who has skills and knowledge related to the construction, installation, and operation of electrical equipment, and has received safety training to recognize and avoid the hazards involved.

Safety and EMC

DANGER

HAZARD OF ELECTRICAL SHOCK, EXPLOSION OR ARC FLASH

Power down all equipment before starting the installation, removal, wiring, maintenance or inspection of the product.

Always use a properly rated voltage sensing device to confirm power is off.

Power line and output circuits must be wired and fused in compliance with local and national regulatory requirements for the rated current and voltage of the particular equipment, i.e. UK, the latest IEE wiring regulations, (BS7671), and USA, NEC class 1 wiring methods.

Failure to follow these instructions will result in death or serious injury.

Reasonable use and responsibility

The safety of any system incorporating this product is the responsibility of the assembler/installer of the system.

The information contained in this manual is subject to change without notice.

While every effort has been made to improve the accuracy of the information, your supplier shall not be held liable for errors contained herein.

This controller is intended for industrial temperature and process control applications, which meet the requirements of the European Directives on Safety and EMC.

Use in other applications, or failure to observe the installation instructions of this manual may compromise safety or EMC. The installer must ensure the safety and EMC of any particular installation.

Failure to use approved software/hardware with our hardware products may result in injury, harm, or improper operating results.

PLEASE NOTE

Electrical equipment must be installed, operated, serviced and maintained only by qualified personnel.

No responsibility is assumed by Schneider Electric for any consequences arising out of the use of this material.

A qualified person is one who has skills and knowledge related to the construction and operation of electrical equipment and its installation, and has received safety training to recognize and avoid the hazards involved.

QUALIFICATION OF PERSONNEL

Only appropriately trained persons who are familiar with and understand the contents of this manual and all other pertinent product documentation are authorized to work on and with this product.

The qualified person must be able to detect possible hazards that may arise from parameterization, modifying parameter values and generally from mechanical, electrical, or electronic equipment.

The qualified person must be familiar with the standards, provisions, and regulations for the prevention of industrial accidents, which they must observe when designing and implementing the system.

INTENDED USE

The product described or affected by this document, together with software and options, is the nanodac™ Recorder / Controller (referred to herein as "programmable controller", "controller" or "nanodac"), intended for industrial use according to the instructions, directions, examples, and safety information contained in the present document and other supporting documentation.

The product may only be used in compliance with all applicable safety regulations and directives, the specified requirements, and the technical data.

Prior to using the product, a risk assessment must be performed in respect of the planned application. Based on the results, the appropriate safety-related measures must be implemented.

Since the product is used as a component within a machine or process, you must ensure the safety of this overall system.

Operate the product only with the specified cables and accessories. Use only genuine accessories and spare parts.

Any use other than the use explicitly permitted is prohibited and can result in unanticipated hazards.

 **DANGER****HAZARD OF ELECTRICAL SHOCK, EXPLOSION OR ARC FLASH**

Apply appropriate personal protective equipment (PPE) and follow safe electrical work practices. See applicable national standards e.g. NFPA70E, CSA Z462, BS 7671, NFC 18-510.

Electrical equipment must be installed, operated and maintained by only suitably qualified personnel.

Refer to manual for installation and servicing.

Turn off all power supplying this equipment before working on the loads of the equipment.

Replace doors and plug-in terminals before turning on power to this equipment.

If on receipt, the unit or any part within is damaged, do not install but contact your supplier.

Do not disassemble, repair or modify the equipment. Contact your supplier for repair.

This product must be installed, connected and used in compliance with prevailing standards and/or installation regulations.

Do not exceed the device's ratings.

The unit must be installed in an enclosure or cabinet connected to the protective earth ground.

Electrically conductive pollution must be excluded from the cabinet in which the product is mounted.

Do not allow anything to fall through the case apertures and ingress the product.

Before any other connection is made, the protective earth ground terminal must be connected to a protective conductor.

Any interruption of the protective earth ground conductor inside or outside the product, or disconnection of the protective earth ground terminal is likely to make the product dangerous under some conditions. Intentional interruption is prohibited. Whenever it is likely that protection has been impaired, the unit shall be made inoperative, and secured against accidental operation. The manufacturers nearest service centre must be contacted for advice.

Power line and output circuits must be wired and fused in compliance with local and national regulatory requirements for the rated current and voltage of the particular equipment, i.e. UK, the latest IEE wiring regulations, (BS7671), and USA, NEC class 1 wiring methods.

Tighten all connections in conformance with the torque specifications. Periodic inspections are required.

Ensure all cables and wiring harness are secured using a relevant strain relief mechanism.

Use appropriate safety interlocks where personnel and/or equipment hazards exist.

Respect electrical installation requirements to ensure optimum IP rating.

Always use a properly rated voltage sensing device to confirm power is off.

Grounding the temperature sensor shield: Where it is common practice to replace the temperature sensor whilst the instrument is live, it is recommended that the shield of the temperature sensor be grounded to a protective earth ground, as an additional protection against electric shock.

Failure to follow these instructions will result in death or serious injury.

⚡⚠ DANGER**HAZARD OF ELECTRICAL SHOCK, EXPLOSION OR ARC FLASH**

The maximum continuous voltage applied between any of the following terminals must not exceed 240Vac.

- 1) Relay output to logic, dc or sensor input connections
- 2) Any connection to ground.

The ac supply must not be connected to sensor input or low-level inputs or outputs.

Ensure the power supply capacitors discharge to a safe voltage, the power supply must be disconnected for at least two minutes, before the instrument is removed from its sleeve. The touching of the exposed electronics of an instrument which has been removed from its sleeve should be avoided.

Failure to follow these instructions will result in death or serious injury.

⚠ DANGER**FIRE HAZARD**

A maximum of two wires, when identical in type and cross sectional size can be inserted per controller terminal or terminal harness connector (where utilized).

The conductor stripping length must be as stated in electrical installation. Ensure all wires that connect to the controller terminals or to the controllers terminal harness connector (without ferrules), do not exceed the maximum exposed conductor length.

Failure to follow these instructions will result in death or serious injury.

⚠ WARNING**UNINTENDED EQUIPMENT OPERATION**

Do not use the product for critical control or protection applications where human or equipment safety relies on the operation of the control circuit.

Signal and power voltage wiring must be kept separate from one another. Where this is impractical, all wires must be rated to the power voltage and shielded cables are recommended for signal wiring. When shielded cable is used, it must be grounded at one end only.

This product has been designed for environment A (Industrial). Use of this product in environment B (domestic, commercial and light industrial) may cause unwanted electromagnetic disturbances in which cases the installer may be required to take adequate mitigation measures.

For Electromagnetic Compatibility, the panel or DIN rail to which the product is attached must be grounded.

Observe all electrostatic discharge precautions before handling the unit.

At commissioning, ensure cybersecurity robustness of the installation.

Failure to follow these instructions can result in death, serious injury or equipment damage.





⚠ CAUTION**UNINTENDED EQUIPMENT OPERATION**

If being stored before use, store within the specified environmental conditions.

Failure to follow these instructions can result in injury or equipment damage.

Symbols

Various symbols may be used on the controller. They have the following meaning:

-  Risk of electric shock.
-  Take precautions against static.
-  Regulatory compliance mark for Australia (ACA) and New Zealand (RSM).
-  Complies with the 40 year Environment Friendly Usage Period.

Hazardous Substances

This product conforms to European **R**estriction **o**f **H**azardous **S**ubstances (RoHS) (using exemptions) and **R**egistration, **E**valuation, **A**uthorisation and Restriction of **C**hemicals (REACH) Legislation.

RoHS Exemptions used in this product involve the use of lead. China RoHS legislation does not include exemptions and so lead is declared as present in the China RoHS Declaration.

Californian law requires the following notice:

 **WARNING:** This product can expose you to chemicals including lead and lead compounds which are known to the State of California to cause cancer and birth defects or other reproductive harm.

For more information go to: <http://www.P65Warnings.ca.gov>.

USB Device Precautions

Note: The use of U3 USB Flash drives is not recommended.

1. Precautions against electrostatic discharge should be taken when the instrument terminals are being accessed. The USB and Ethernet connections are particularly vulnerable.
2. Ideally, the USB device should be plugged directly into the instrument, as the use of extension leads may compromise the instrument's ESD compliance. Where the instrument is being used in an electrically noisy' environment however, it is recommended that the user brings the USB socket to the front of the panel using a short extension lead. This is because the USB may lock up' or reset in noisy environments and the only means of recovery is to remove the device, then re-insert it. For memory sticks, EMC-related failure during a write operation might cause corruption of the data held on the stick. For this reason, the data on the memory stick should be backed up before insertion and checked after removal.
3. When using a USB extension cable, a high quality screened cable must be used. The total length of USB cable between the device and the USB port must not exceed 3 metres (10 ft.).
4. Most barcode readers and keyboards are not designed for use in industrial EMC environments, and their operation in such environments may result in impaired performance of the recorder/controller.

32-BIT Resolution

Floating point values are stored in IEEE 32-bit single precision format. Values which require greater resolution than is available in this format are rounded up or down.

Cybersecurity

What's in this Chapter

This chapter outlines some good practice approaches to cybersecurity as they relate to use of the nanodac instrument, and draws attention to several nanodac features that could assist in implementing robust cybersecurity.

Introduction

When utilising the nanodac in an industrial environment, it is important to take 'cybersecurity' into consideration: in other words, the installation's design should aim to prevent unauthorised and malicious access. This includes both physical access (for instance via the front panel or HMI screens), and electronic access (via network connections and digital communications).

Secure Network Topologies and Good Practices

Overall design of a site network is outside the scope of this manual. The Cybersecurity Good Practices Guide, Part Number HA032968 provides an overview of principles to consider. This is available from www.eurotherm.com.

Typically, an industrial controller such as the nanodac together with any associated HMI screens and controlled devices should not be placed on a network with direct access to the public Internet. Rather, good practice involves locating the devices on a fire-walled network segment, separated from the public Internet by a so-called demilitarized zone' (DMZ).

Security Features

The sections below draw attention to some of the cybersecurity features of the nanodac.

Principle of Secure by Default

Some of the digital communication features on the nanodac can provide greater convenience and ease-of-use (particularly in regards to initial configuration), but also can potentially make the controller more vulnerable. For this reason, some of these features are turned off by default. In particular, ID061 (the BACnet port is closed unless the BACnet option is enabled).

HMI Access Level / Comms Config Mode

As described in [Login \(page 49\)](#), the nanodac device features tiered, password-restricted user access levels, so that available functions and parameters can be restricted to appropriate personnel.

Note: User accounts of any access level require a password, otherwise they will not be available for selection.

Logged Out Access Level

Logged out mode allows the user to select viewing mode, to view history, to view alarms, to toggle faceplate cycling on and off, to send notes, to suspend/resume IISR

Operator Access Level

In addition to the logged out features, Operator access level allows the user to acknowledge alarms, to edit notes and to perform demand archive operations. By default, a password is required to enter Operator level. Passwords can be configured either at Supervisor level or at Engineer level.

If the Auditor feature is enabled, the Operator user is pre-configured as 'User 1'. See next section for details.

Customizable Users

Overview

A total of 25 customizable user accounts are available. With the exception of 'User 1' which is pre-configured to replace the 'Operator' user account, the remaining 24 are disabled by default and require the 'Login Disabled' permission to be enabled and a unique password provided.

Each user account can automatically inherit the 'Logged Out' access level, however the user can further choose to inherit the permission sets from any of the following base users:

- Operator (these permissions can be individually configured)
- Supervisor (inherits as a set)
- Engineer (inherits as a set)

The following example demonstrates the number of user account types that can be configured.

- 24 Operator Users + 0 Supervisory Users + 1 Engineer User, or
- 23 Operator Users + 1 Supervisory User + 1 Engineer User, or
- 10 Operator Users + 10 Supervisory Users + 5 Engineer Users, or
- 13 Operator Users + 9 Supervisory Users + 3 Engineer Users, etc.

Username

The username for each user can be up to 20 characters in length. Typically, only the first 12 characters are displayed in scroll lists (such as when logging on) due to space. When logging in, the user account number (1 to 25) is prefixed to the username so that each name is unique by default.

Password

The password for each user can be up to 20 characters in length, and should contain a selection of numbers, letters, uppercase, lowercase, etc. to provide a strong password for enhancing cybersecurity.

Configurable parameters per user

The following parameters are configurable for each user. Refer to "User Accounts (Auditor)" on page 107 for further details:

Permission	Description
Batch Control	Yes = Control batches via batch control page
Ack Alarms	Yes = Acknowledge alarms in the alarm summary screen
Demand Archiving	Yes = Access to the demand archiving screen
Login Disabled	Yes = Disable this account
Signing	Yes = This user will appear in the list when required to sign for an action
Authorising	Yes = This user will appear in the list when required to authorise an action
Archive Interval	Yes = Modify the archive interval rate
Loop Control	Yes = Change the mode, manual OP in control loop screens
Program Mode	Yes = Change the mode of programs
Program Edit	Yes = Edit programs
Program Store	Yes = Store programs
Supervisor	Yes = Inherits Supervisor user access level (mutually exclusive with Engineer)
Engineer	Yes = Inherits Engineer user access level (mutually exclusive with Supervisor)

Supervisor Access Level

In addition to the logged out features, this access level allows the user to view the recorder's configuration, and to edit some values (such as alarm thresholds).

Engineer Access Level

This allows full access to all areas of the recorder configuration.

HMI Passwords

When entering passwords via the HMI, the following features help protect against unauthorised access:

- Each digit is obscured (replaced with an asterisk character) after entry, to help protect against an unauthorized person seeing the password as it is typed in.
- Password entry is locked after a configurable number of invalid attempts (if Auditor option is enabled). If this number of attempts is exceeded, the User account is disabled. This helps protect against "brute force" attempts to guess the password.

- The controller records the number of successful and unsuccessful login attempts for each level of password. This is recorded in the History. Regular auditing of this History is recommended, as a means to help detect unauthorized access to the controller.

Ethernet security features

Ethernet connectivity is available on the nanodac. The following security features are specific to Ethernet:

Ethernet rate protection

One form of cyberattack is to try to make a controller process so much Ethernet traffic that this drains systems resources and useful control is compromised. For this reason, the nanodac device includes an Ethernet rate protection algorithm, which will detect excessive network activity and help to ensure the controller's resources are prioritized on the control strategy rather than the Ethernet. If this algorithm is activated, a message will be entered into the History.

Broadcast Storm protection

A 'broadcast storm' is a condition which may be created by cyberattack: spurious network messages are sent to devices which cause them to respond with further network messages, in a chain reaction that escalates until the network is unable to transport normal traffic. The nanodac device includes a broadcast storm protection algorithm, which will automatically detect this condition, stopping the controller from responding to the spurious traffic. If this algorithm is activated, a message will be entered into the History.

Configuration backup and recovery

Using the iTools software, you can 'clone' a nanodac device, saving all its configuration and parameter settings to a file. This can then be copied onto another controller, or used to restore the original controller's settings. Clone files are digitally signed using an SHA-256 cryptographic algorithm, meaning that if the file contents is tampered with, it will not load back into a controller.

Memory Integrity

When a nanodac device powers up, it automatically performs an integrity check on the contents of its internal non-volatile memory devices. Additional periodic integrity checks are performed during normal runtime and when non-volatile data is being written. If any integrity check detects a difference from what is expected, the controller enters Standby mode and a message is displayed on then screen.

Firmware

From time to time, to provide new functionality or address known issues, Eurotherm may make new versions of the nanodac firmware available.

This firmware may be downloaded from the Eurotherm website, and transferred to a nanodac instrument in the field, via a USB memory stick (or FTP server).

⚠ CAUTION

NON-SCHNEIDER ELECTRIC FIRMWARE

There is a potential risk that an attacker could upgrade a nanodac with non-genuine firmware that contains malicious code. To mitigate this potential risk, genuine nanodac firmware upgrade utility executables are always supplied digitally signed with the publisher as Schneider Electric. Do not use a firmware upgrade utility if it has not been signed by Schneider Electric.

Failure to follow these instructions can result in injury or equipment damage.

Supported Protocols and Threat Mitigations

The nanodac supports the following protocols on Ethernet. For each protocol, a list of mitigations are provided. As a general comment, the firewall is configured to block all ports **except** those required for installed/enabled options.

FTP Client

An external FTP client can access the FTP server on the instrument. This FTP server has a remote username and password for each of the users (that will need configuring). Passwords can be modified and additional users can be added with configurable remote usernames and passwords.

To mitigate threats:

1. Physically protect access to subnet(s) in use.
2. Firewall to block TCP port 21.
3. It is recommended that user's should change their passwords regularly, this could be done manually or by using the password expiry feature.

FTP Server

Up to two external FTP servers can be configured. The nanodac will then connect to these servers as an FTP client and push archive files to the servers.

Threat mitigation as for FTP Client.

ICMP (ping)

The nanodac will respond to a ping to aid network diagnostics.

To mitigate threats:

1. Physically protect access to subnet(s) in use.
2. Use a firewall to block ICMP / ping.

DHCP

The nanodac can allocate its IP address using DHCP; however this is typically set to fixed IP address allocation by configuration. The DHCP server could be spoofed allocating an invalid IP address to the instrument.

To mitigate threats:

1. Use fixed IP address allocation.
2. Physically protect access to subnet(s) in use.

SNTP

The nanodac can support SNTP for network time synchronisation.

To mitigate threats:

1. Physically protect access to subnet(s) in use.
2. Firewall to block UDP port 123

ModBus

The nanodac supports ModBus, which can be configured to act as Master via TCP and Slave via serial or TCP.

To mitigate threats:

1. Physically protect access to subnet (or serial cabling) in use.
2. Firewall to block TCP port 502 (or alternate non-standard port if so configured).

HTTP (Web Server)

To mitigate threats:

1. Physically protect access to subnet(s) in use.
2. Firewall to block TCP port 80.

UHH Navigator

To mitigate threats:

1. Physically protect access to subnet(s) in use.
2. Firewall to block TCP port 50010.

Ethernet IP

To mitigate threats:

1. Physically protect access to subnet in use.
2. Firewall to block TCP port 2222. This port is opened when Ethernet IP option is enabled.

BACnet

To mitigate threats:

1. Physically protect access to subnet in use.
2. Firewall to block UDP port 47808. This port is opened when BACnet option is enabled.

Decommissioning

When a nanodac instrument is at the end of its life and being decommissioned, Eurotherm advises reverting all parameters to their default settings using the Engineer Password 'ResetConfig' or via iTools (see "Security menu" on page 98 and "iTOOLS" for instructions). This can help to protect against subsequent data and intellectual property theft if the controller is then acquired by another party.

Legal Information

The information provided in this documentation contains general descriptions and/or technical characteristics of the performance of the products contained herein. This documentation is not intended as a substitute for and is not to be used for determining suitability or reliability of these products for specific user applications. It is the duty of any such user or integrator to perform the appropriate and complete risk analysis, evaluation and testing of the products with respect to the relevant specific application or use thereof. Schneider Electric, Eurotherm Limited or any of its affiliates or subsidiaries shall be responsible or liable for misuse of the information contained herein.

If you have any suggestions for improvements or amendments or have found errors in this publication, please notify us.

You agree not to reproduce, other than for your own personal, non-commercial use, all or part of this document on any medium whatsoever without permission of Eurotherm Limited, given in writing. You also agree not to establish any hypertext links to this document or its content. Eurotherm Limited does not grant any right or license for the personal and noncommercial use of the document or its content, except for a non-exclusive license to consult it on an "as-is" basis, at your own risk. All other rights are reserved.

All pertinent state, regional, and local safety regulations must be observed when installing and using this product. For reasons of safety and to help ensure compliance with documented system data, only the manufacturer should perform repairs to components.

When devices are used for applications with technical safety requirements, the relevant instructions must be followed.

Failure to use Eurotherm Limited software or approved software with our hardware products may result in injury, harm, or improper operating results.

Failure to observe this information can result in injury or equipment damage.

Eurotherm, EurothermSuite, ECAT, EFit, EPack, EPower, Eycon, Eyris, Chessell, Mini8, nanodac, optivis, piccolo and versadac are trademarks of Eurotherm Limited SE, its subsidiaries and affiliated companies. All other trademarks are the property of their respective owners.

© 2021 Eurotherm Limited. All rights reserved.

Introduction

This document describes the installation, operation and configuration of a paperless graphic recorder/controller. The instrument comes, as standard, with four input channels and is equipped for secure archiving via FTP transfer and/or to USB memory stick.

Unpacking the Instrument

The instrument is despatched in a special pack, designed to give adequate protection during transit. Should the outer box show signs of damage, it should be opened immediately, and the contents examined. If there is evidence of damage, the instrument should not be operated and the local representative contacted for instructions. After the instrument has been removed from its packing, the packing should be examined to ensure that all accessories and documentation have been removed. The packing should then be stored against future transport requirements.

Installation

⚡ ⚠ DANGER

HAZARD OF ELECTRICAL SHOCK, EXPLOSION OR ARC FLASH

Do not exceed the device's ratings.

Failure to follow these instructions will result in death or serious injury.

Before installation, ensure that the specified instrument supply voltage matches the facility supply.

Mechanical Installation

Figure 1 gives installation details.

Installation Procedure

1. If it is not already in place, fit the IP65 sealing gasket behind the front bezel of the instrument.
2. Insert the instrument through the panel cutout, from the front of the panel.
3. Spring the retaining clips into place, and secure the instrument by holding it firmly in place whilst pushing both clips towards the rear face of the panel.
4. The protective membrane can now be removed from the display.

For the sake of clarity, the panel is shown as though transparent

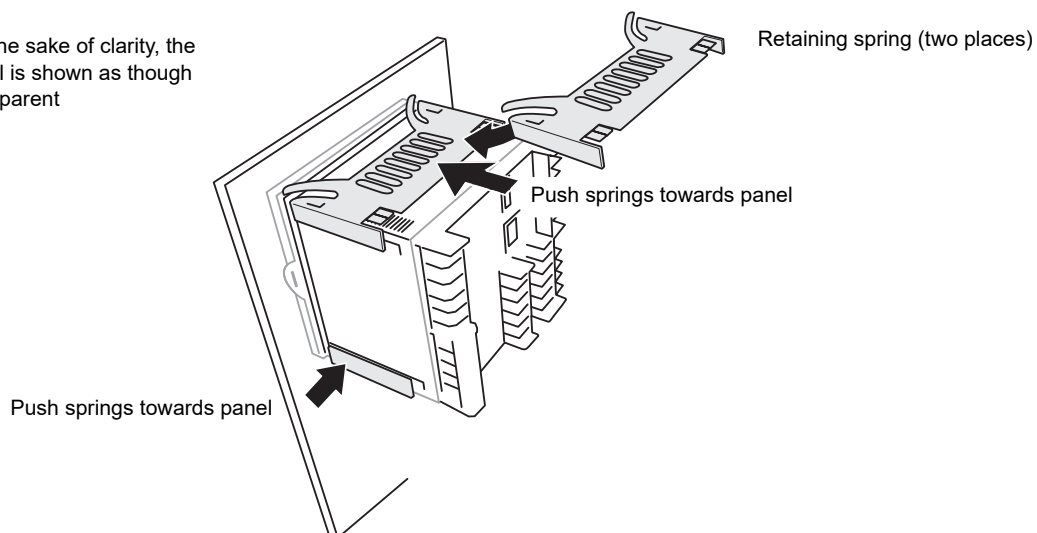

Figure 1 Securing the Instrument

Demounting

DANGER

HAZARD OF ELECTRICAL SHOCK, EXPLOSION OR ARC FLASH

Apply appropriate personal protective equipment (PPE) and follow safe electrical work practices. See applicable national standards e.g. NFPA70E, CSA Z462, BS 7671, NFC 18-510.

Turn off all power supplying this equipment before working on the loads of the equipment.

Failure to follow these instructions will result in death or serious injury.

1. Isolate the mains supply and secure it against accidental operation. Remove all wiring and the USB device and Ethernet cable (if any).
2. Remove the retaining springs by unhooking them from the sides using a small flat-blade screwdriver.
3. Pull the instrument forwards out of the panel.

Removing the Instrument from its Sleeve

The instrument is designed to be removed from its sleeve from the front panel. However, if a USB memory stick or the Ethernet cable is fitted then this must be removed first.

When the instrument is shipped from the factory it is fitted with two small red clips, one in the top side of the sleeve and the other below. These are intended as a safeguard against removal of the instrument from its sleeve when an Ethernet cable is fitted. These clips must also be removed, using a small screwdriver, before the instrument can be taken out of its sleeve.

Ease the latching ears ([Figure 2](#)) outwards and pull the controller forward.

When plugging back in ensure that the latching ears click into place to maintain the panel sealing.

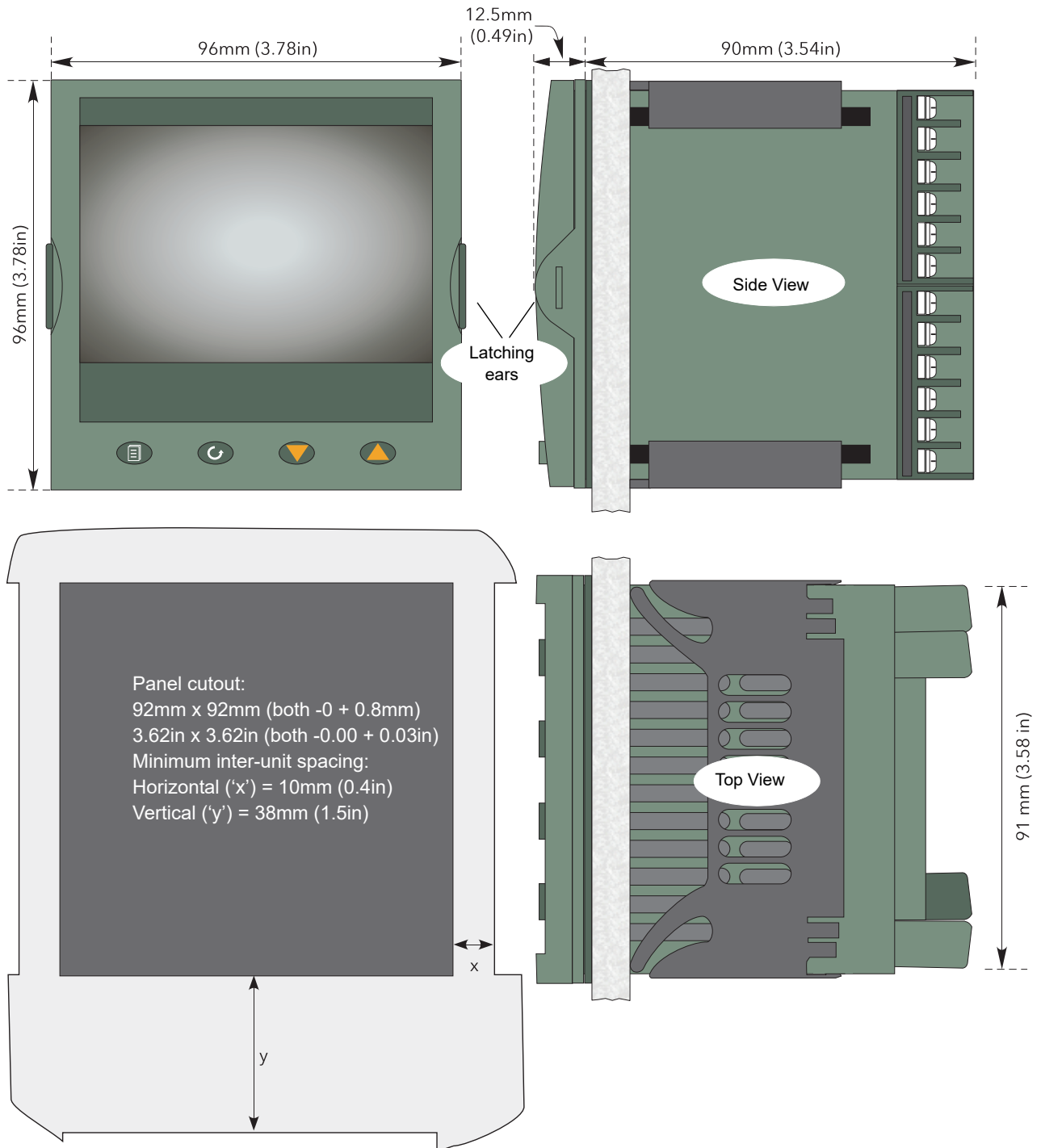

Figure 2 Mechanical installation details (standard case)

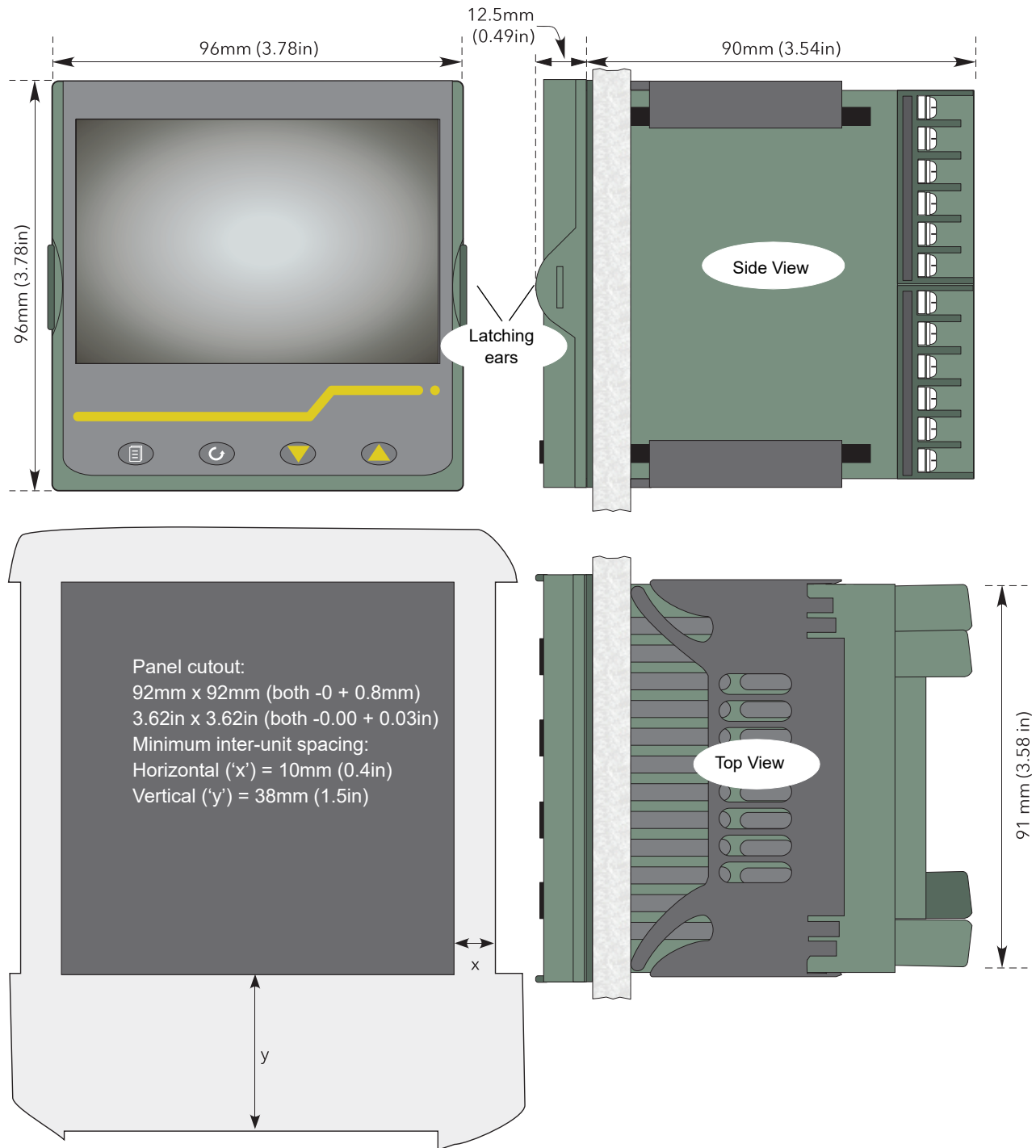
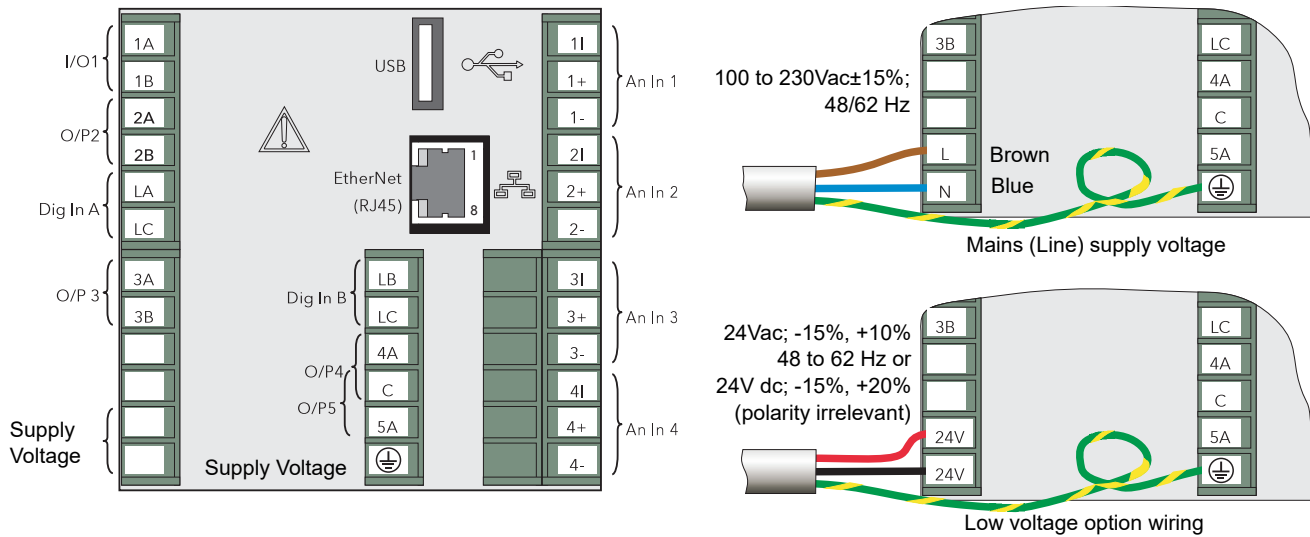

Figure 3 Mechanical installation details (wash down case option)

Electrical Installation

Figure 4 shows the locations of the various user terminations along with signal and supply wiring pinouts.



I/O1							
<p>R > 500R = inactive R < 150R = active</p> <p>1A 1B</p>	<p>1A 1B 2A</p>	<p>1A 1B 2A</p> <p>com no</p>	<p>1A 1B 2A</p>				
Contact closure	Logic o/p (active high)	Relay output	Isolated DC o/p (mA)				
O/P2			Each wire connected to LA, LB and LC must be less than 30 metres in length.				
<p>1B 2A 2B LA</p>	<p>1B 2A 2B LA</p>	<p>1B 2A 2B LA</p> <p>com no</p>					
Isolated DC o/p (mA)	Logic o/p (active high)	Relay output					
O/P3		Dig In A		Dig In B		O/P4; O/P5	
<p>3A 3B</p> <p>com no</p>	<p>3A 3B</p>	<p>2B LA LC</p>	<p>LB LC 4A</p>	<p>4A C 5A E</p> <p>com no</p> <p>com no</p>	<p>R > 600R = inactive R < 300R = active</p>		
Relay output	Isolated DC o/p (mA/V)	Contact closure	Contact closure	Relay output			
An In1; An In2; An In3; An In4							
<p>I + -</p>	<p>I + -</p>	<p>I + -</p>	<p>I + -</p>	<p>I + -</p>	<p>I + -</p>	<p>R < 200R = active R > 350R = inactive</p>	
T/C, Volts, millivolts	Milliamps	RTD (three wire)	RTD (two wire)	Ohms inputs	Digital		
An In1; An In2; An In3; An In4							
<p>I + + -</p> <p>Primary Secondary</p>	<p>I + + -</p> <p>Primary Secondary</p>						
Dual mV/TC	Dual mA						

Dual input option ("Dual Input Option" on page 31, below)
(Primary and secondary inputs are not electrically isolated from one another.)
For maximum accuracy, it is recommended that separate returns are made to the negative terminal.

Figure 4 Connector locations and pinouts (rear panel)

Installation Requirements

NOTICE

Safety requirements for permanently connected equipment state:

1. A switch or circuit breaker shall be included in the building installation.
2. The switch/circuit breaker will be in close proximity to the equipment and within easy reach of the operator.
3. It shall be marked as the disconnecting device for the equipment.

Note: Recommended external fuse ratings are: 2A Type T 250V.

Termination details

The screw terminals accept single wires in the range 0.21 to 2.08mm² (24 to 14 AWG) inclusive, or two wires each in the range 0.21 to 1.31mm² (24 to 16 AWG) inclusive. Screw terminals should be tightened to a torque not exceeding 0.4Nm (3.54lb in).

Low Voltage Option

This option allows the use of a low voltage ac or dc 24V supply. The specification in Appendix A gives full details. The polarity of the dc supply connection is not important -it may be connected either way round.

Dual Input Option

This is a cost option, enabled on a channel-by-channel basis by means of entering the relevant password in the 'Feature3 Pass' field in Instrument.Security menu described in Section 6.1.6.

For each enabled channel, a pair of thermocouple, mV or mA inputs can be connected to the instrument. These inputs are called 'primary' and 'secondary', and are terminated at the analogue input terminals (An In1 to An In 4) as shown in [Figure 4](#), above. The primary inputs 1 to 4 are assigned to channels 1 to 4, as normal. Each secondary input must be soft wired to a maths channel configured as Operation = 'Copy' if it is to be recorded/ displayed/alarmed etc.

Note: Due to the nature of the input circuit, a large offset may appear for secondary thermocouple inputs. This offset can be removed only by using the input adjust feature described in "Input adjust" on page 103. Because of this offset, the dual thermocouple input option is not suitable for AMS2750D applications.

Soft wiring is described in "iTOOLS".

Maths channels are described in "Maths channel configuration" on page 133.

Channel configuration is described in "Channel Main" on page 123.

Input adjust is carried out as described in "Input adjust" on page 103.

Sample Rate

For dual input channels, both primary and secondary sample rate is reduced to 4Hz

Sensor Break Detection

Input sensor break detection is not supported for secondary inputs. The internal circuit acts as a 'pull up' on the secondary input which therefore saturates high in the event of a sensor break.

Dual Milliamp Offset Correction

If 'Dual mA' is selected as input type, then an automatic offset correction will be made, according to the shunt value entered in channel configuration. Refer to "Channel Main" on page 123 for further information.

Input Range Limitation

There is no 10V range associated with the secondary input. Any input greater than +2V or less than -2V is deemed to be 'bad range'.

Modbus Master communications

The master instrument can be connected directly to up to two slaves using standard Ethernet network cable either directly (single slave only) or via a hub or switch (one or two slaves). In either case, 'straight through' or 'crossover' cable may be used. The cable is terminated at the RJ45 socket at the rear of the unit.

EtherNet/IP

The Client and Server are connected in the same way as described above for Modbus Master communications, except that there can be only one client and one server.

Operation

On power up a default or custom splash screen appears and remains visible whilst the unit is initialising. If during this process a network broadcast storm is detected, the unit stops, displaying a network failure icon until the broadcast storm has cleared, after which the initialisation process resumes.



Introduction - Initial Setup



Figure 5 Engineer password configuration screen - at initial start.

At initial start, after installation the unit will display the Engineer password configuration screen, see [Figure 5](#).

The Engineer password must be configured to allow any further operation, see [Engineer Password - Configuration](#).

Note: The initial Engineer password screen only appears after a Clone file load or firmware upgrade, if no engineer password was configured. All user accounts require an associated password.



NOTICE

ENGINEER ACCESS DENIED

When configuring the Engineer password, ensure the password can be recalled and entered correctly. An incorrect password will prevent Engineer access (lock out) and any further configuration or use of the controller. Contact your local Eurotherm support desk in the unlikely event of being locked out.

Note: Please read the following information regarding the units display screen and navigation controls to familiarize yourself with all the controls and their associated functions, see [Operator Interface \(page 34\)](#).

Engineer Password - Configuration

1. From the Engineer password configuration screen, press the scroll button . The *Engineer Pass* panel appears.
2. Enter a password, using the raise and lower buttons ( ) which in turn will move the highlighted key, and pressing the scroll button to enter each character.

- Press the Page button (), once you have completed typing the Engineer password.

The *Accept changes?* panel will appear with the following options:

- *Cancel* - cancels the panel and returns to the keyboard
 - *No* - cancels the panel and returns to the Engineer password configuration screen
 - *Yes* - enters the password
- Select *Yes* to enter the password.
Use the raise button twice (or the lower button once) to highlight the word 'Yes' and press the scroll key to confirm.

The Engineer password is accepted and completed. The display mode screen will appear, see [Figure 6 Display mode screen \(vertical trend\)](#).

The Engineer password is configured at initial start up, but can also be updated when required. The Engineer password must only be associated with and used when logging in at Engineer level access, for further details see:

- [Login \(page 49\)](#)
- [To Log in as Engineer \(page 51\)](#)
- [Security menu \(page 98\)](#)

Operator Interface

The operator interface consists of a display screen and four push buttons.

Display Screen

The display screen is used both to display channel information (in one of a number of display modes), and to display the various configuration screens which allow the user to setup the recorder to display the required channels, to set up alarms and so on. Display modes are described in "Display Modes" on page 52 below; configuration is described in "Configuration".

In display mode, the screen is split horizontally into three areas ([Figure 6](#)):

1. A faceplate giving channel details.
2. the main display screen showing channel traces etc.
3. the status area, displaying instrument name, the current time and date and any system icons.

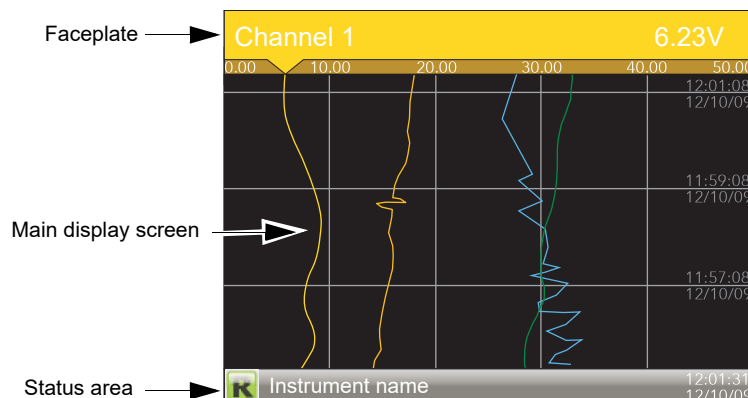

In configuration mode, the entire display screen is devoted to the selected configuration menu.

Navigation Pushbuttons

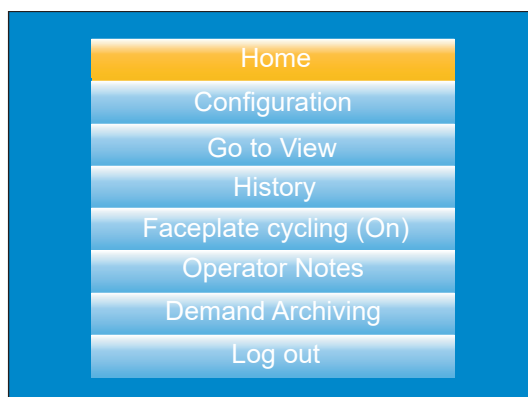

Figure 7 Top level menu (Engineer level access)

There are four navigation buttons, called 'Page', 'Scroll', 'Lower' and 'Raise' located below the screen. The general properties of these buttons are described in the remainder of this section, but some have additional, context sensitive functions, which, for the sake of clarity are not described here but in the relevant sections (e.g. 'Message summary') of the manual.

Page Button

From any non-configuration page, pressing this push button causes the top level menu (Figure 7) to appear. The figure shows the menu for a user logged in with 'Engineer' level access. Other access levels may have fewer menu items.

Within configuration pages, the Scroll button can be used as an enter key to select lower menu levels. In such cases the page button is used to reverse this action, moving the user up one menu level per operation.

Scroll Button

From trending pages, operation of the scroll push-button scrolls through the channels enabled in the group. The Faceplate cycling 'Off' selection can be used to keep a particular channel permanently displayed, and the scroll pushbuttons can then be used to select channels manually.

In configuration pages, the scroll key operates as an 'enter' key to enter the next menu level associated with the highlighted item. Once the lowest menu level is reached, operation of the scroll key allows the value of the selected item to be edited by the relevant means (for example, the raise/lower keys, or a keyboard entry).

The 'Page' key is used to move the user back up the menu structure, until the top level menu is reached, when the scroll key can be used again to return to the Home page. The scroll button is also used to initiate user wiring as described in "iTOOLS".

Raise/Lower Buttons

Within trending displays, the Raise and Lower keys can be used to scroll through the enabled display modes in the sequence: vertical trend, horizontal trend, vertical bargraph, horizontal bargraph, numeric, vertical trend... and so on.

Within configuration pages, these pushbuttons act as cursor keys, allowing, for example, the user to highlight menu items for selection using the scroll button, and in many cases allowing the user to select one from a number of alternative values within menu items. These keys are also used to navigate through the virtual keyboards ("Text Entry" on page 89) and number pads used to enter text or numeric strings.

On Screen Help

The top level configuration menu includes contextual help text on the right-hand half of the screen. Mostly this text fits within on screen height. Where this is not the case, the text can be moved up or down the screen by holding the Page button operated whilst using the up and down arrows to move the text.

The down arrow moves the text upwards on the screen; the up arrow moves it downwards.

(Use the Page button with the down arrow to access hidden text at the bottom of the screen)

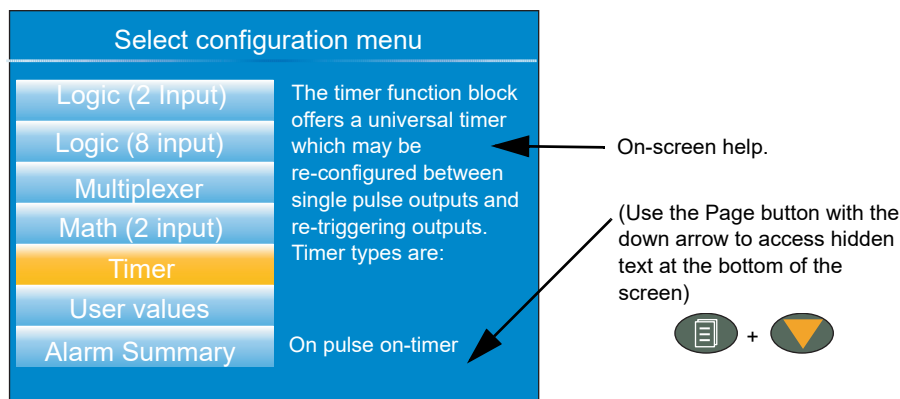

Figure 8 On-screen help (typical)

Process Variable Display

As discussed above, the operator interface consists of a display screen and associated push buttons. The display screen shows process variables in one of a number of formats, or operational details (notes or alarm history for example), or configuration details for use in setting up the recorder to produce the required displays and history formats. The remainder of this section discusses the process variable displays, alarm displays and so on; configuration details are to be found in "Configuration".

Note: Some of the items below can be selected for use only by users with a suitable permission level as set up in the 'Instrument' 'Security' menu described in "Security menu" on page 98.

Figure 9 depicts a typical trend display and gives details of the various areas of the display page.

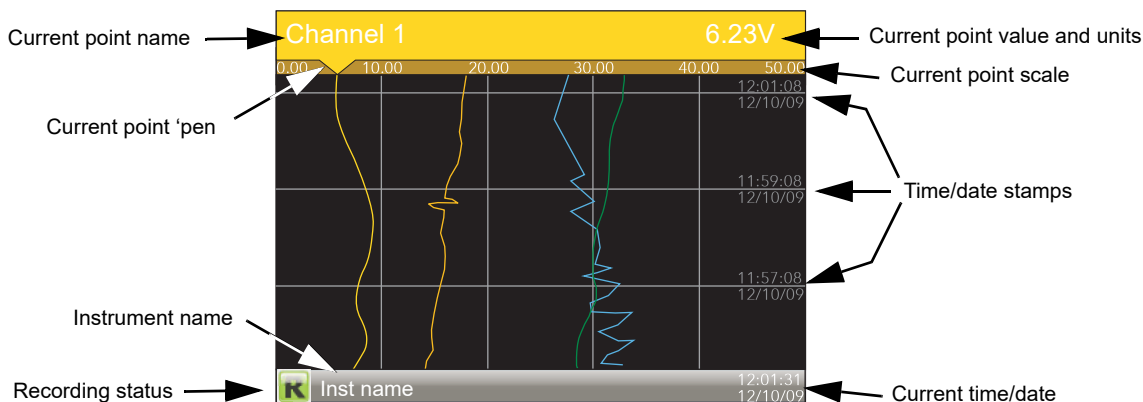

Figure 9 Typical display screen (Vertical trend)

Figure 9 shows a vertical trend page. Operating the Raise/Lower push-buttons allows the user to scroll through the other display modes: Horizontal trend, Vertical bargraph, horizontal bargraph, numeric, vertical trend... and so on. All these display modes are described in "Display Modes" on page 52, below.

A display mode can also be selected from the Top level menu 'Go To View' item which appears when the 'Page' key is operated.

The scroll button can be used to scroll through the points in the group, overriding the 'Faceplate Cycling' on or off selection

Alarm Icons

Note: A full discussion of alarms is given in the Channel Configuration section of this manual, "Alarm 1 menu" on page 128.

Note: Trigger alarms do not display threshold marks or bars, or faceplate symbols.

The alarm icons shown below appear in some display modes. The icons on a channel faceplate show the status of that channel's alarm(s), as follows:

- Icon is flashing alarm is active but unacknowledged or it is an Auto alarm which is no longer active but which has not been acknowledged.
- Icon steadily illuminated the alarm is active and has been acknowledged.

Alarm thresholds and deviation alarm bars appear for horizontal and vertical trend modes. For deviation bars, the bar stretches from (Reference - Deviation) to (Reference + Deviation). Vertical and Horizontal bargraph modes display only absolute alarm symbols.

▲	Absolute High
▼	Absolute Low
▲	Deviation High
▼	Deviation Low
◆	Deviation Band
▲	Rising Rate of change
▼	Falling Rate of change
▲	Digital High
▼	Digital Low

Status Bar Icons

The following items can appear in a dedicated window immediately to the left of the time and date, at the bottom right-hand corner of the display. The width of this window expands as the number of icons increases, and the instrument name is truncated, as necessary, to make room.

System Alarms

This indicator appears, flashing, if any one or more of the alarms listed below is active. The System Alarms summary page (accessed from 'Go to View in the top level menu) allows the user to view such system alarms as are active. It is not possible to 'acknowledge' system alarms

Archive Disabled	An unattended archiving strategy has temporarily been disabled.
Archiving Failed	An unattended archiving strategy has failed to complete.
Archiving Timeout	A configured archiving strategy has timed out.
Battery failure	Indicates that the battery is approaching the end of its useful life, or that it is missing or is completely exhausted. Immediate battery replacement is recommended ("Appendix C: Reference", "Battery" on page 431).
Broadcast Storm detected	Networking is limited until the storm has passed.
Clock failure	The internal clock was found to be corrupt at power up, or that the time has never been set. Time is forced to 00:00 1/1/1900. Can be caused by battery failure, in which case a battery failure message appears. The error is cleared by setting the time and date.
Channel error	Indicates a hardware failure in the channel circuit or in the internal cold junction temperature measurement.
Database failure	Corrupted EEPROM or flash memory.
DHCP Server failure	For units with 'IP Type' set to 'DHCP' (Network.Interface configuration) this alarm occurs if the instrument is unable to obtain an IP address from the server.
FTP Archiving file lost	A file has been deleted that had not yet been archived. Possible causes: Communications with the server could not be established,; archive is disabled; archive rate too slow.
FTP Archiving to slow	The archive rate is too slow to prevent the internal memory from overflowing. The recorder effectively switches to 'Automatic' ("Archiving" on page 111) to ensure that data is not lost.
FTP Primary Server Failure	This error occurs if the recorder fails to establish connection with the primary server, after two attempts. After the second attempt fails, the recorder attempts to establish connection with the secondary server instead. Primary and secondary server details are entered in the Network. Archiving area of configuration ("Archiving" on page 111).
FTP Secondary Server Failure	This error occurs if the recorder fails to establish connection with the secondary server, after two attempts. Primary and secondary server details are entered in the Network. Archiving area of configuration ("Archiving" on page 111).

Maths channel failure	Appears if, for example, the divisor of a divide function is zero.
Media archiving file lost	A file has been deleted that had not yet been archived. Possible causes: memory stick missing, full or write protected; archiving has been disabled; archiving rate too slow.
Media archiving too slow	The archive rate is too slow to prevent the internal memory from overflowing. The recorder effectively switches to 'Automatic' ("Archiving" on page 111) to ensure that data is not lost.
Media full	Archive storage device is full. The alarm becomes active only when an archive is in progress.
Media missing	No archive storage device present when archive attempted.
Non-volatile memory failure	RAM copy of non-volatile parameters is corrupted.
Non-volatile Write Frequency warning	One or more parameters are being written frequently to non-volatile memory. If this continues, it may lead to 'memory depletion' (i.e. the memory will no longer be able to store values correctly). A common cause of this problem is frequent writes over Modbus comms.
Recording failure (message)	Message explains reason for failure.
SNTP failure	Invalid data received from SNTP server, for example, the year received from the server is <2001 or >2035, or the server cannot be accessed.
Time synchronisation failure	Instrument time has failed to synchronise with SNTP server. If more than 5 'Time change events' occur within 24 hours a 'Time synchronisation failure' alarm is set. The alarm occurs 24 hours after the first event. Once synchronisation is re-established, the alarm self-clears within 24 hours. A 'Time change event' occurs whenever the recorder time is found to be more than two seconds different from the server time. If the instrument time differs from the SNTP time by less than two seconds, the instrument time is updated gradually (1ms, eight times a second) to prevent time changes being recorded. SNTP time is based on elapsed seconds since 00:00 hours on 1st January 1900. The time is not affected by time zones or daylight saving adjustments.
USB overcurrent	USB power fault - too much current (i.e. >100mA) is being drawn by a USB device.
Wiring failure	The user wiring has failed to verify, i.e. one or more wires has been detected that does not have both a source and a destination defined. This may be the result, for example, of power loss during a download from iTools.

Channel Alarm

This indicator appears if any channel (including channels not in the display group) is in an alarm state. The symbol is illuminated continuously if all alarms are acknowledged or flashes if any one or more alarms is unacknowledged. Alarms are acknowledged from the Root menu 'Alarm summary' item as described in "Go to View" on page 43 or in the Channel configuration area ("Alarm 1 menu" on page 128)

USB

This icon appears whenever a memory stick (max. capacity 8GB) or other supported USB device ("USB Devices")

is plugged into the USB port at the rear of the recorder. When data transfer is in progress between the instrument and the memory stick, the icon changes to a 'busy' version.

NOTICE

LOSS OF DATA

The memory stick must not be removed whilst archiving (demand or automatic) is in progress.

Removal of the memory stick during archiving may irreparably damage the file system of the memory stick, rendering it unusable. It is recommended that all archiving is suspended before the memory stick is removed.

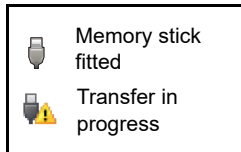

FTP Icon

The FTP icon appears whenever transfer activity is taking place.

Record Icon

One of four icons appears at the bottom left corner of the display to indicate recording status.

Record 

This indicates that the recorder is recording the items selected in the Group Recording area of configuration ("Group Configuration" on page 117).

Stopped 

This means that 'Enable' has been set to 'no' in the Group Recording area of configuration ("Group Configuration" on page 117). Trending is not affected.

Paused (Suspended) 

This means that recording has been paused by a wire to the Suspend parameter (Group Recording area of configuration ("Group Configuration" on page 117) going true (high). Trending is not affected.

In Configuration 

The recorder has been placed in configuration mode either at the user interface, or via iTools. Recording is stopped until the recorder is no longer in configuration mode. For each non-recording state (Stopped, Paused or In Configuration). A new history file is created when the unit comes out of configuration mode.

Note: For recording to be enabled, configuration status must be 'logged out' both at the instrument and at iTools.

Message Icon

This 'envelope' icon appears when a message is generated and it remains on display until the Message Summary (see "Message Summary" on page 44) is accessed,

Autotune Icon

For instruments fitted with the Loop option, this symbol appears during the Autotune process.

Breaks in recording

Breaks in recording can be caused by the unit being powered down, by the user entering configuration mode or when the recorder time is changed manually. In vertical and horizontal trend modes, a line is drawn across the width/height of the chart to indicate that recording has been interrupted.

On power up, a red line is drawn across the chart. In 'History', if messages are enabled the message:

Date Time System power up

is printed on the chart, together with the configuration and security revisions.

On exiting configuration mode, a blue line is drawn on the chart and in 'History', if messages are enabled, the messages:

Date Time Logged out.

Date Time Config Revision: N was N-1 assuming a configuration change was made)

Date Time Logged in as: Engineer

appear on the chart.

When the instrument time is changed (manually - not through daylight saving action) a green line is drawn on the chart and in 'History', if messages are enabled, the message:

Date Time Time/Date changed

appears on the chart.

Top Level Menu

This menu appears when the page key is operated from any non-configuration page. The menu items displayed depend on the access permission of the user. One of the menu items is highlighted, and if the scroll key is operated, then it is the highlighted item that is 'entered'.

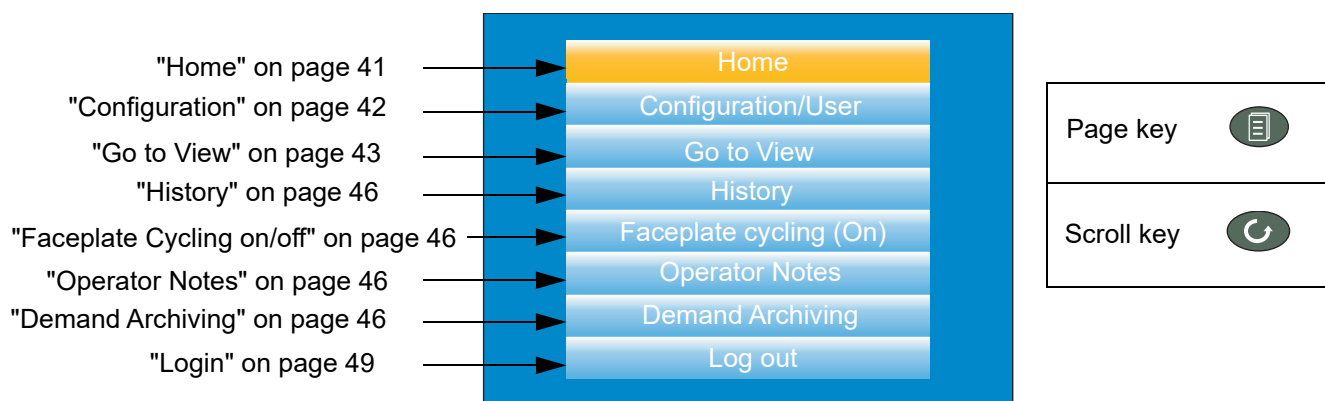

Figure 11 Top level menu

Home

Operating the scroll key whilst 'Home' is highlighted causes a return to the 'Home' page. By default, this is the vertical trend mode, but the mode can be changed in

Configuration

Operating the down arrow key highlights the 'Configuration' item. Operating the Scroll key enters the configuration submenu described in "Configuration".

Note: 'Configuration' appears only if the user has an appropriate access level.

Note: If the Auditor feature is enabled, additional user accounts are available. If one of these users are logged in, the 'Configuration' menu option is replaced by the 'User' menu option instead (see "User menu" on page 42).

User menu

If the Auditor feature is enabled, up to 25 additional user accounts are available with configurable access permissions and each requiring a configured password.

If one of these users are logged in, the 'Configuration' menu option is replaced by a 'User' menu option which provides the ability for the user to change their password and set the Archive Interval (if the user has appropriate permissions).

Operating the scroll key whilst the 'User' item is highlighted, displays the individual user account menu, as shown in the following figure. The menu title matches that of the username used to log in.

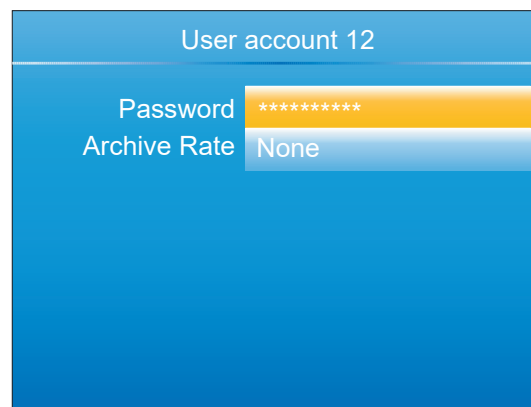

Figure 12 User menu

Password	Allows the user to change their password (up to a maximum of 20 characters). The minimum password length can be configured using the Min Password Len parameter in the Security menu (see "Security menu" on page 98).
Archive Rate	Allows the user to specify the frequency at which the contents of the flash memory are archived to the USB port, or via FTP, to a PC. Scrollable settings are:
None:	Automatic archiving is disabled. Any archiving must be initiated by the user using Demand Archiving.
Minute:	Archive is initiated on the minute, every minute.
Hourly:	Archive is initiated at 00:00 each day.
Weekly:	Archive is initiated at midnight every Sunday.
Monthly:	Archive is initiated at 00:00 on the 1st of every month.
Automatic:	The recorder selects the least frequent of the above archive periods which is guaranteed not to lose data as a result of the internal flash memory running out of space.

This field is editable if the logged in user has appropriate permissions to adjust the archive interval (see "User Accounts (Auditor)" on page 107). For further information on archiving, refer to "Archiving" on page 111.

Go to View

Operating the scroll key whilst the 'Go to view' item is highlighted, calls the Go to view submenu (Figure 13). This allows the user to view channel alarms, system alarms, messages or to select a different display mode.

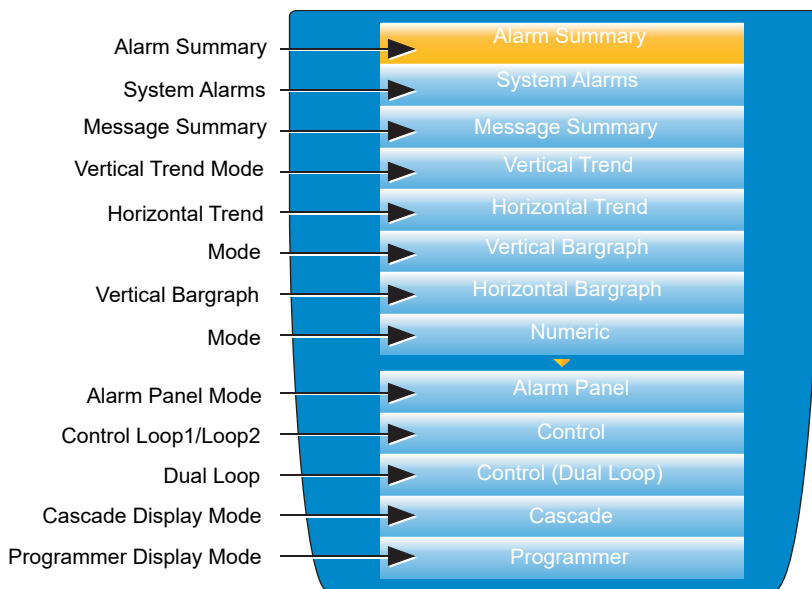

Figure 13 Go to view submenu

Note: If an option (e.g. 'Steriliser') is not fitted, its display mode does not appear in the list.

Note: Some display modes must be enabled in Instrument.View configuration ("Display configuration" on page 94) before they become available.

Alarm Summary

For each active alarm, this page displays the channel identifier with alarm number (e.g. C1(2) = channel 1; alarm 2), the channel descriptor, the alarm threshold the current process value and an alarm type symbol. To return to the top level menu, operate the Page key.

Note: The background colour to the channel ID is the same as that chosen for the channel.

Note: A prefix 'C' in the channel ID means that this is a measuring channel; A prefix 'V' means that this is a virtual channel (i.e. a totaliser, counter or maths channel).

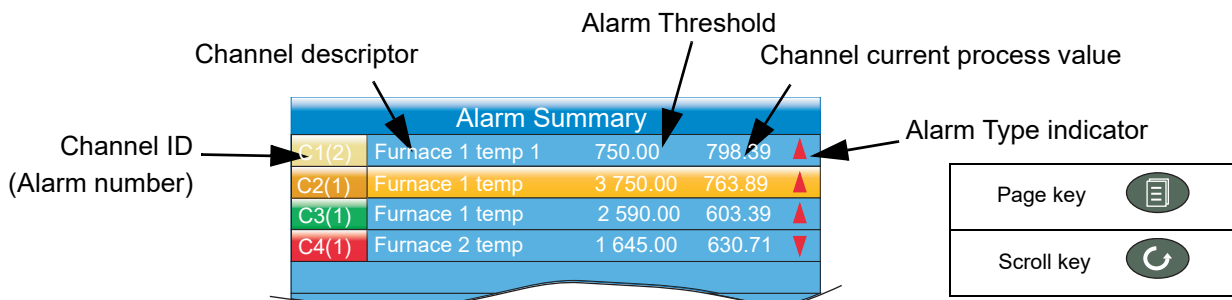
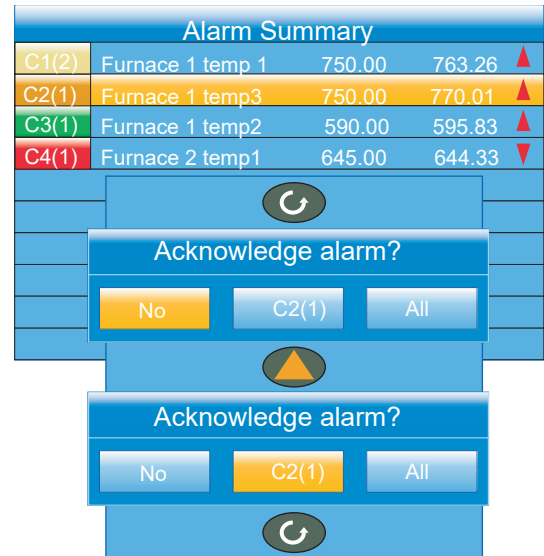

Figure 14 Alarm summary page with acknowledge confirmation display

Alarm Acknowledgement

To acknowledge an alarm from this view:

1. Use the up and down arrows to highlight the required alarm.
2. Operate the scroll button. The 'Acknowledge alarm' window appears.
3. Use the up arrow to highlight the relevant field (C2(1) in this example), or 'All' if all alarms are to be acknowledged.
4. Operate the scroll key to confirm. If the alarm fails to respond, this may be due to the fact that it has been configured as a 'Manual' alarm, and the trigger has not yet returned to a 'safe' (non-alarm) state, or it could be that the instrument is in a logged out state.



System Alarms

Operating the scroll button whilst the 'System Alarms' field is highlighted displays a list of all currently active system alarms. "Status Bar Icons" on page 38 contains a list of system alarms and their interpretations. To return to the top level menu, operate the Page key.

A further operation of the scroll button displays a 'Help Information' page, giving the reason for the highlighted alarm. Operate the scroll button again to return to the system alarm display.

Message Summary

Operating the scroll key whilst the 'Message summary' field is highlighted displays the ten most recent

messages. Operating the scroll key whilst a message is highlighted shows the selected message in more detail (and using the up/down keys allows the other messages to be scrolled through). Whilst in this mode, operating the scroll key again, allows the user to choose to jump to the message's location in trend history mode ("Trend History" on page 87) or to return to the summary page.

By default, the interface is set up such that:

1. all message types are included.
2. the up and down arrow keys cause the highlighted selection to move up or down by one message at a time.

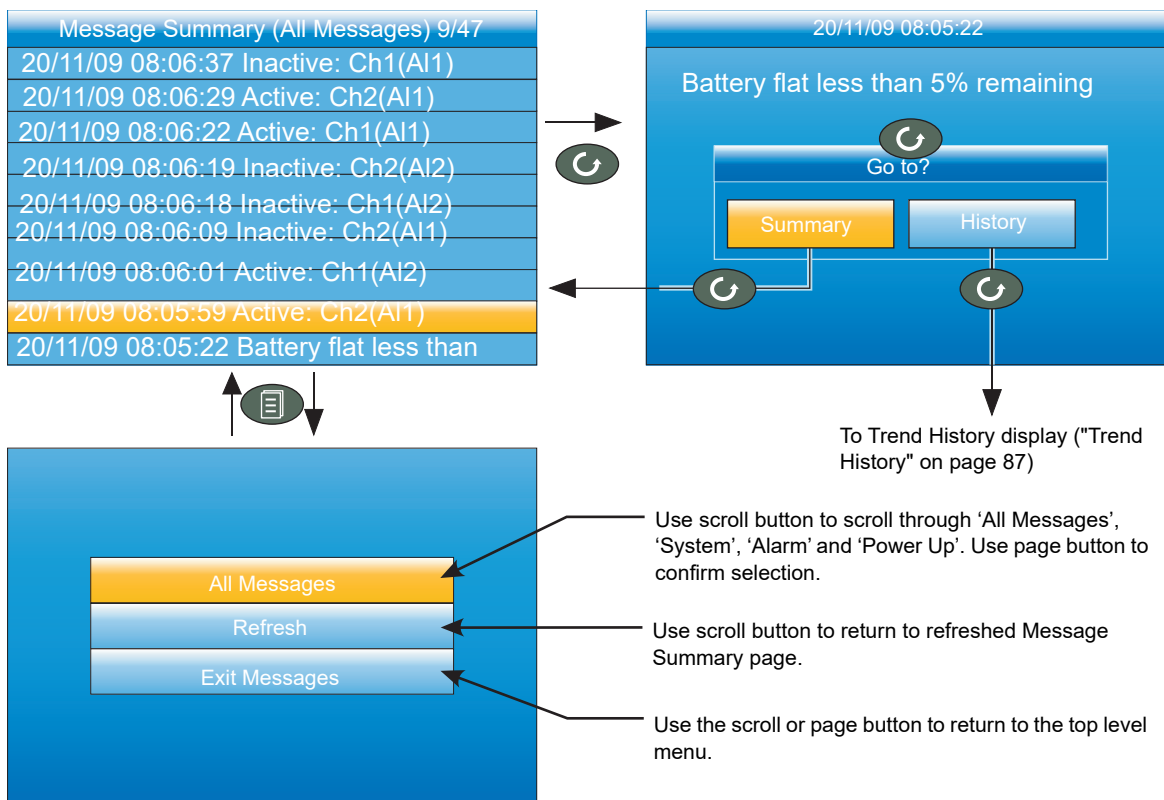

Figure 15 Message summary features

MESSAGE FILTERS

- All Messages Causes all messages to be displayed on the screen.
- System Shows only system alarms.
- Alarm Shows only channel alarms.
- Power up Shows only power up messages.
- Login/out Limits the display to Log in and Log out events.

Display Mode Selection

Use the up/down arrow buttons to highlight the required display mode. Once the required display mode is highlighted, operation of the scroll button causes the recorder to leave the 'Go to View' menu and to display channel values in the selected mode. See "Display Modes" on page 52 for a description of the various display modes.

Alternatively the up and down arrow buttons can be used from any of the display modes to cycle through the available modes in the order listed in the figure.

Note: If an option (e.g. 'Steriliser') is not fitted, its display mode is not available for selection.

Note: Some display modes must be enabled in Instrument. Display configuration ("Display configuration" on page 94) before they become available.

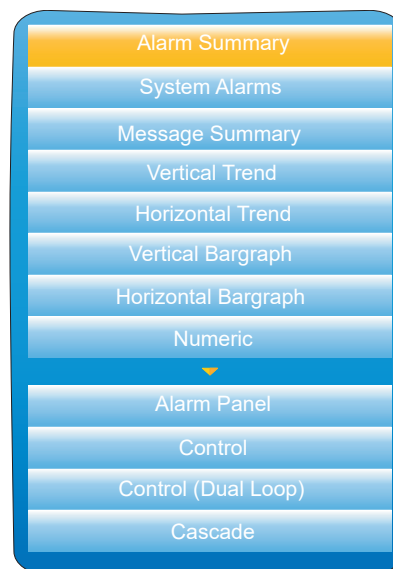

History

This top level menu item allows the user to switch from real-time trending to review mode, where channel values, messages, alarm triggers, etc. can be viewed back as far as the last significant configuration change. History mode is fully discussed in "Trend History" on page 87.

Faceplate Cycling on/off

For the purposes of this document the channel whose faceplate is currently displayed and whose 'pen' symbol is visible is called the 'Active' channel. By default, the recorder scrolls through all the channels in the display group, with each channel becoming the active channel in turn. This top level menu 'Faceplate Cycling' item allows the user to inhibit this scrolling action such that the currently active channel remains active permanently, or until a manual scroll is performed using the scroll button (or until Faceplate Cycling is re-enabled).

'Faceplate Cycling' is highlighted by using the up/down arrow buttons. Once highlighted, the status can be changed from 'On' to 'Off' or vice-versa using the scroll button. Operation of the 'Page' button returns to the trend display.

Operator Notes

This area allows up to 10 notes to be created when logged in as Engineer, using either the text entry techniques described in "Text Entry" on page 89, or "iTOOLS" described in "iTOOLS". Once logged out, operating the scroll button whilst a note is highlighted calls a selection box allowing the user either to send that note to the chart, or to write a Custom Note.

Custom Note

The Custom Note is written using the text entry techniques described in "Text Entry" on page 89. Once the note is complete, operation of the page button calls a confirmation display. The down arrow is used to highlight 'Yes', and when the scroll key is then operated, the message is sent to the chart. The user name is added to the start of the custom note when saved. This custom note is not retained for further use, so if it is required on a regular basis, it is suggested that one of the Operator Notes 1 to 10 be configured (Engineer access level required) so that it may be used instead.

Note: Note: Each note can contain up to 100 characters.

Demand Archiving

This allows a user, with a high enough access level, to archive a selected portion of the recorder history, either to a 'memory stick' plugged into the USB port at the rear of the recorder (Local Archiving), or to a PC, by means of the FTP protocol (Remote Archiving). The archived data remains in the flash memory of the instrument. When the flash memory is full, new data causes the oldest file(s) to be discarded.

The up and down arrow keys are used to navigate to the required field.

Archive Menu

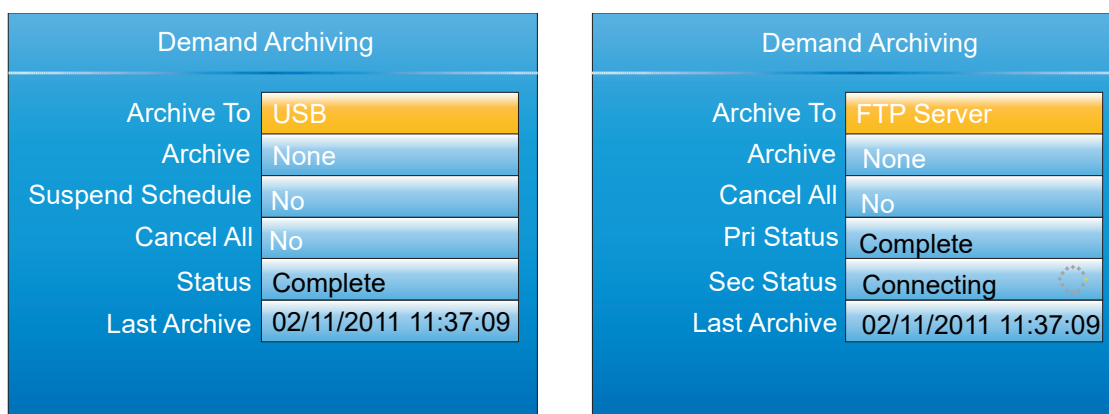

Figure 16 Demand Archiving menu (Local Archiving on left; Remote Archiving on right)

Archive To	With this item highlighted, the scroll button and the up/down arrows can be used to select 'USB' or 'FTP Server'. For 'USB', the archive will be made to the rear USB memory stick. For 'FTP Server' the archive will be made to the Primary or Secondary server (configured in the Network Archive area of configuration described in "Archiving" on page 111. For more details about remote archiving, see 'Remote archiving', below.
Archive	In a similar way, select the archive period: None: No archiving to take place. (Not editable when logged out). Last Hour: Archives all files created within the last 60 minutes. Last Day: Archive all files created in the last 24 hours. Last Week: Archives all files created in the past seven days. Last Month: Archives all files created in the past 31 days. Archive All: Archives all the files in the recorder's history. Bring To Date: Archives all files created or updated since the 'Last Archive' date and time.
Suspend Schedule	When set to 'Yes', automatic (scheduled) archiving is stopped, once the transfer of the current file is complete. Suspend Schedule must be set to 'No' again, to restart the suspended archive. Suspend can be used to allow the memory stick to be removed and re-fitted safely.
Cancel All	When set to 'Yes', this cancels USB archiving activity immediately, or cancels FTP archiving once transfer of the current file (if any) is complete.
Last Archive	Shows the date and time at which the last archive (demand or automatic) was attempted. If a demand archive is requested, or is in operation when an automatic archive is triggered, the automatic archive takes precedence.
Status	For Archive to USB only: 'Complete' means that no archiving is currently taking place. 'Transferring' indicates that an archiving is in progress. Accompanied by an animated circular display. 'Suspended' means that archiving has been suspended as requested.
PriStatus	For Archive to FTP Server only, this shows the transfer status between the instrument and the primary host computer.
SecStatus	For Archive to FTP Server only, this shows the transfer status between the instrument and the secondary host computer.

FTP Server Archiving

This allows the archiving of recorder files to a remote computer via the RJ45 type connector at the rear of the recorder, either directly or via a network. In order to carry out a successful transfer:

1. Details of the remote host must be entered in the Network.Archive area of configuration ("Archiving" on page 111).
2. The remote computer must be set up as an FTP server. Help from the user's IT department may be necessary in order to achieve this. Appendix C, "Setting Up An FTP Server Using Filezilla" on page 431 to this manual suggests one way, using Filezilla.
3. The remote computer must also be set up to respond to 'pings'. This is because the instrument pings the host whilst establishing connection, and if it does not receive a response the archive attempt fails.

When accessing files using Microsoft® Internet Explorer, the address (URL) field can be in one of two formats:

1. ftp://<instrument IP address>. This allows a user to log in as the anonymous user (if the recorder has any account with the user name set to 'anonymous' with a blank password).
2. ftp://<user name>:<password>@<instrument IP address> to log in as a specific user.

Microsoft® Internet Explorer displays, by default, history files only. To quit the history folder, either uncheck the Tools/Internet Options/Advanced/Browsing/Enable folder view for FTP sites' option, or check the Tools/Internet Options/Advanced/Browsing/Use Web based FTP' option.

Review Software

'Review' is a proprietary software package which allows the user to extract 'archive' data from one or more suitable instruments* and to present this data on a host computer, as if on a chart, or as a spreadsheet. The host computer must be set up as an FTP server (see Appendix C, "Setting Up An FTP Server Using Filezilla" on page 431 for a description of one way of doing this).

As described in the Review help system, 'Review' allows the user to set up a regular transfer of data (using FTP) from connected instruments into a database on the PC, and then from this database to the chart or spreadsheet. The chart/spreadsheet can be configured to include one or more 'points' from one or all connected instruments (where a 'point' is an umbrella term for channel, totaliser, counter etc.).

It is also possible to archive instrument history files to a memory stick, Compact Flash card etc. (depending on instrument type) and to use this to transfer the data to the PC.

Each type of instrument has its own remote user name and password configuration.

*Suitable instruments are connected instruments, the archive files of which have the suffix '.uhh'.

Login

Login allows the user to enter a password in order to gain access to areas of the unit's configuration which are not available when the user is logged out.

Passwords are required for the additional 25 user accounts, when the Auditor feature is enabled. Failed login attempts are recorded in the history. It is recommended that a strong password, that is difficult to guess is used. Failed login attempts are recorded in the history.

Note: User accounts of any access level require a password, otherwise they will not be available for selection.

Logged Out Access Level

Logged out mode allows the user to select viewing mode, to view history, to view alarms, to toggle faceplate cycling on and off, to send notes, to suspend/resume USB archiving and to access the login process.

Operator Access Level

In addition to the logged out features, Operator access level allows the user to acknowledge alarms, to edit notes and to perform demand archive operations.

By default, a password is required to enter Operator level. Passwords can be configured either at Supervisor level or at Engineer level.

If the Auditor feature is enabled, the Operator user is disabled and instead replaced by the 25 User accounts (see section User Access Level below).

Note: The User 1 account defaults to a user with a user name of "Operator" in this instance (with no additional permissions), which can be kept, disabled, modified or overridden if necessary or desired.

Supervisor Access Level

In addition to the logged out level function, this access level allows the user to view the recorder's configuration, and to edit some values (such as alarm thresholds). The password for the Supervisor level must be configured, if the access level is to be used (and can be changed) in the Instrument area of configuration, either at Supervisor or Engineer access level, see [Security menu \(page 98\)](#). It is recommended that a strong password be used.

When the Auditor feature is enabled, it is regarded as best practise that the Supervisor level is not used at all. This can be enforced by disabling the Supervisor level altogether (refer to the 'Sup Log Disabled' parameter in [Security menu \(page 98\)](#)). With the Supervisor access level disabled, only the Engineer level can view (and change) the instrument's configuration.

Engineer Access Level

This allows full access to all areas of the recorder configuration. The Engineer password must be configured at initial start see [Introduction - Initial Setup \(page 33\)](#) and can be changed in the Instrument area of configuration by the existing Engineer access level user, see [Security menu \(page 98\)](#). It is recommended that a strong password be used.

Note: Recording is stopped for as long as the user is logged in at Engineer level, even if the recorder is not being configured. This is indicated by the Record icon at the bottom left corner of the process value display screen being replaced by the Configuration (wrench) icon.

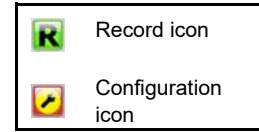

If the Auditor feature is enabled, it is recommended to only use the Engineering level within the context of a formal change control procedure.

User Access Level

If the Auditor feature is enabled, an additional 25 user accounts are available which can be configured to provide customisable levels of permission on a per-account basis. When this is done, the standard Operator Access Level is disabled, and the Logged Out user has no permissions. When logging in as one of these 25 user accounts, the account number (1 to 25) is prefixed to the user name. Refer to "User Accounts (Auditor)" on page 107 for details on how to configure these user accounts and the permissions available to be assigned to each. Failed login attempts are written to the history, as is the user being disabled if a maximum number of failed login attempts is exceeded.

Login Procedure

From the top level menu, use the up or down arrow keys as often as necessary in order to highlight 'Login', and then operate the Scroll key to produce the 'Access Logged out' display.

Note: This procedure describes how to login to an access level with a password - all access levels (user accounts) require a password, otherwise they will not be available for selection.

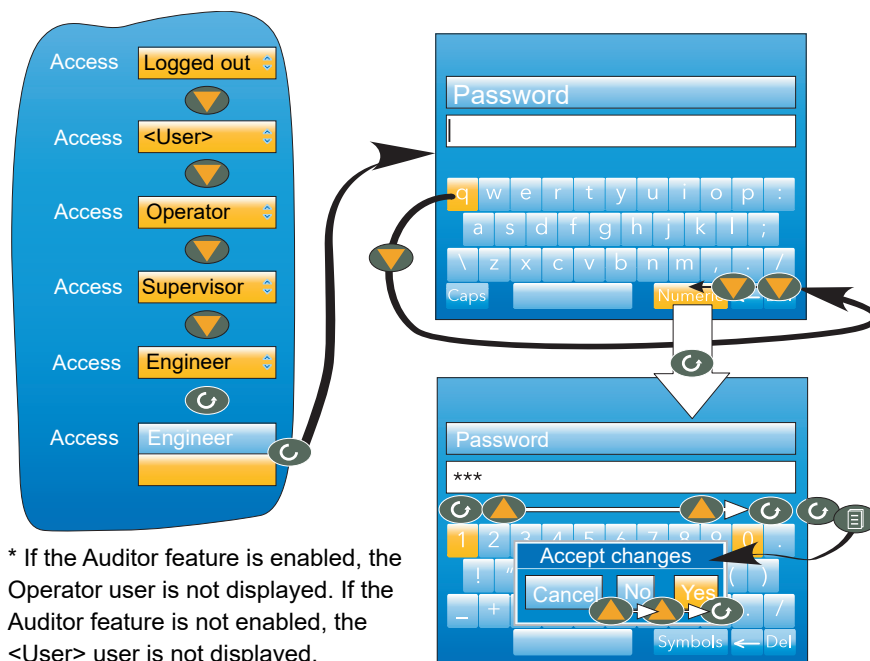

* If the Auditor feature is enabled, the Operator user is not displayed. If the Auditor feature is not enabled, the <User> user is not displayed.

Figure 17 Log in Menu

To Log in as Engineer

Note: Use the Engineer password configured at initial set up, see [Introduction - Initial Setup \(page 33\)](#) for further details.

1. From the *Log in* panel, press the up arrow key and select *Engineer*.
2. Press the scroll key twice.
The 'alpha' keyboard, with the letter 'q' highlighted appears.
3. Enter the Engineer password configured at Initial Setup, using the raise and lower buttons which, in turn will move the highlighted key, press the scroll button to enter each selected character.
4. Press the Page button, once you have completed typing the Engineer password.

The *Accept changes?* panel will appear with the following options:

- *Cancel* - cancels the panel and returns to the keyboard
 - *No* - cancels the panel and returns to the Engineer password configuration screen
 - *Yes* - enters the password
5. Select *Yes* to enter the password.
Use the raise button twice (or the lower button once) to highlight the word 'Yes' and press the scroll key to confirm.

The *configuration menu* appears. (See [Configuration \(page 91\)](#) for further details).

Display Modes

The following subsections describe the various display modes available to the user. By default, the 'Home' display mode is 'Vertical Trend', but this can be edited as a part of 'Instrument.Display' configuration ("Display configuration" on page 94). This configuration area also allows the user to disable one or more display modes should they not be required.

The current display mode can be chosen either by using the top level menu 'Go to View' item or, from any display mode, by scrolling through the enabled modes using the up or down arrow buttons.

Details of the various display modes are to be found in the following subsections:

Vertical trend"Vertical Trend Mode" on page 52

Horizontal trend"Horizontal Trend Mode" on page 53

Vertical bargraph"Vertical Bargraph Mode" on page 54

Horizontal bargraph"Horizontal Bargraph Mode" on page 54

Numeric "Numeric Mode" on page 55

Alarm panel"Alarm Panel Mode" on page 56

Control loop 1/2"Control Loop1/Loop2" on page 57

Cascade "Cascade Display Mode" on page 58

Programmer (inc. future trend)"Programmer Display Mode" on page 59

Steriliser "Steriliser Display Mode" on page 70

Batch "Batch Summary" on page 75

Promote list"Promote list" on page 77

Modbus Master"Modbus Master display mode" on page 78

EtherNet/IP"EtherNet/IP display mode" on page 80

Vertical Trend Mode

In this mode, channel values are traced as though on a chart rolling downwards (i.e with the latest data at the top). The chart speed, and the number of major divisions are configured in the 'Group.Trend' area of configuration ("Group Trend configuration" on page 117). By default, the chart background is black, but this can be changed to white or grey in the 'Instrument' 'Display' area of configuration ("Display configuration" on page 94).

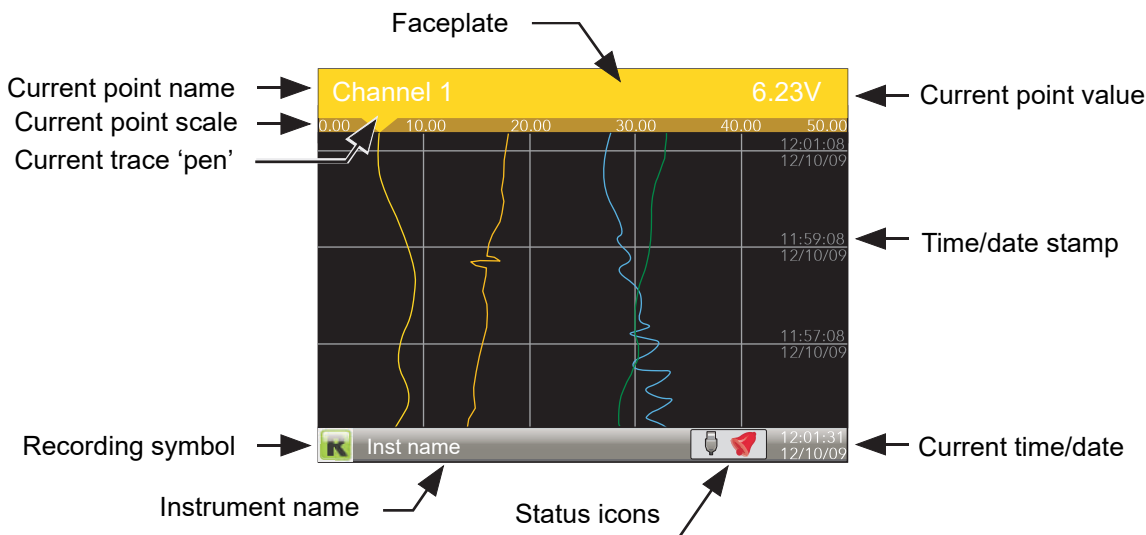

Figure 18 Vertical trend mode display elements

One of the channels is said to be the 'current' or 'scale' channel. This channel is identified by its pen icon being displayed, and by the channel descriptor, dynamic value and its scale being displayed on a 'faceplate' across the width of the display, above the chart.

Each channel in the Group becomes the 'current' channel in turn, for approximately five seconds -i.e. the channels are cycled through, starting with the lowest numbered channel. Once the final channel in the Group has been displayed for five seconds, the first channel is returned-to and the process repeats. This scrolling behaviour can be enabled/disabled from the top level menu 'Faceplate Cycling (Off)' item described in "Faceplate Cycling on/off" on page 46.

The scroll button can be used to cycle through the channels manually in both Faceplate cycle on and off modes. Use of the up arrow button causes the next enabled display mode to be entered (default = horizontal trend). The page key calls the top level menu.

Horizontal Trend Mode

This view is similar to the vertical trend mode described in "Vertical Trend Mode" on page 52 above, except that the traces are produced horizontally rather than vertically. Initially, as each channel appears, its scale appears at the left edge of the display (as shown below), but in order to show the maximum amount of trend data, the scale is overwritten after a few seconds.

By default, after a few seconds, the 'chart' expands leftwards to hide the scale. This feature can be disabled in the Instrument.Display area of configuration ("Display configuration" on page 94, H.Trend scaling) so that the scale is permanently on display.

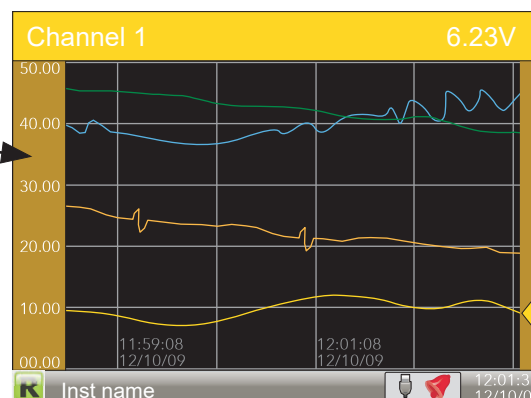

Note: Timestamps appear to the right of the gridline to which they relate.

Use of the up arrow button causes the next enabled display mode to be entered (default = vertical bargraph). Use of the page key calls the top level menu.

Vertical Bargraph Mode

This display mode shows the channel values as a histogram. Absolute alarm threshold values appear as lines across the bars, grey if the alarm is not triggered; red if the alarm is triggered. Alarm symbols appear for active alarms.

Bargraph widths for four to six channels divide the width of the display screen equally between them. For one and two channels, the width is fixed, and the bars are centred on the screen. Figure 19 shows some examples (not to the same scale).

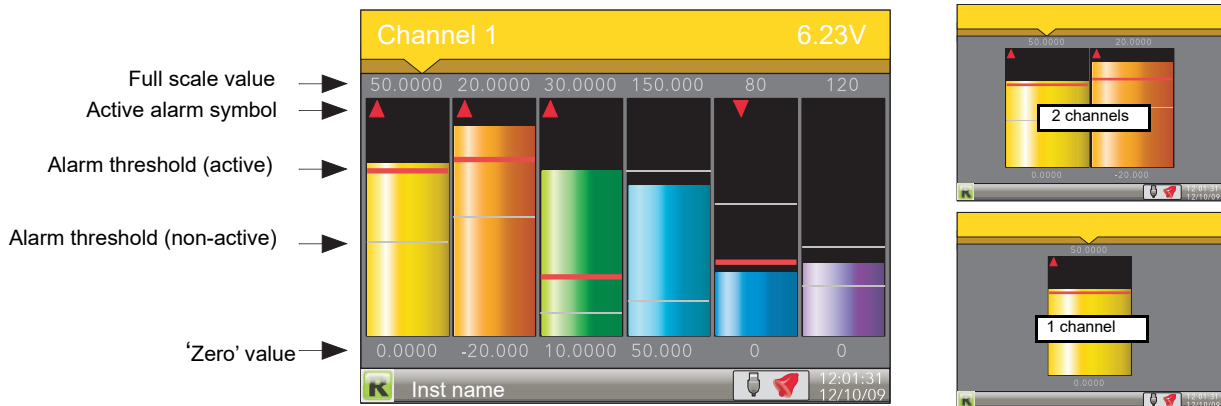

Figure 20 Vertical bargraph display mode

Use of the up arrow button causes the next enabled display mode to be entered (default = horizontal bargraph). Use of the page key calls the top level menu.

Horizontal Bargraph Mode

Similar to the Vertical bargraph mode described in "Vertical Bargraph Mode" on page 54, above, but includes channel descriptors.

The scroll button toggles the text between point descriptor (as shown) and point value.

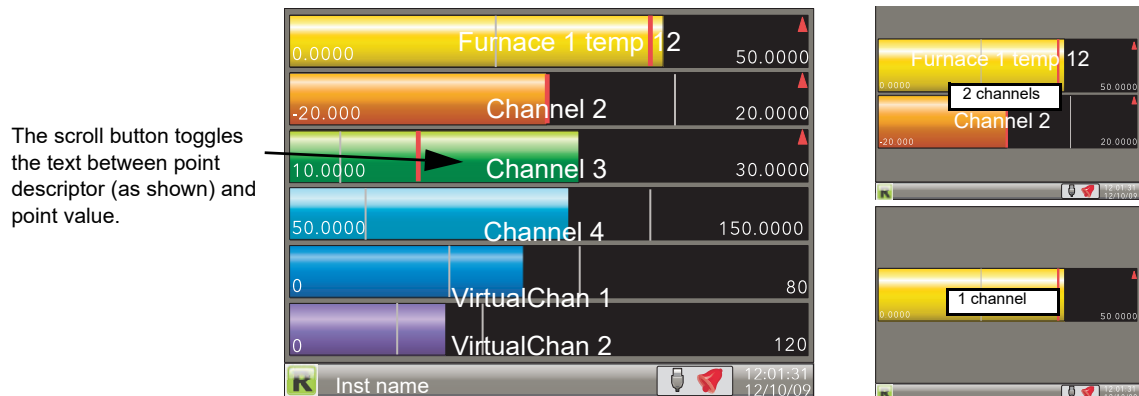

Figure 21 Horizontal bargraph mode

Use of the up arrow button causes the next enabled display mode to be entered

Numeric Mode

Shows the enabled channels' values along with their descriptors and with indications of the type(s) of alarm configured for each channel.

Alarm type indication

(see [Figure 10](#))

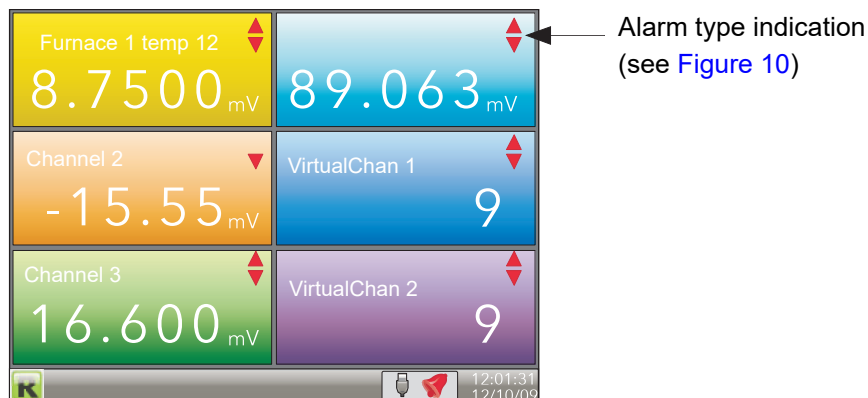

Figure 22 Numeric display mode (six enabled channels)

The figure above shows an example where the Trend group contains six channels. [Figure 23](#) shows how the display appears for trend groups with fewer than six channels configured.

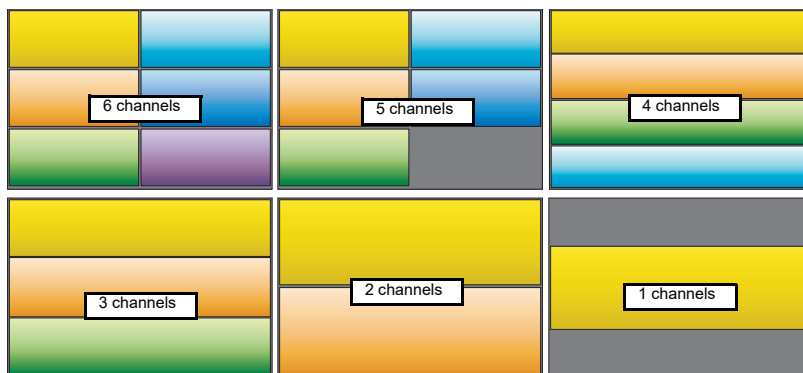

Figure 23 Display layout for different numbers of channels

The up arrow button returns to the vertical trend display mode; the page key calls the top level menu.

Alarm Panel Mode

This display appears only if enabled in the Instrument Display configuration ("Display configuration" on page 94). Alarm panel mode shows current value and alarm status for each channel enabled in the Trend Group. The status is shown in two ways, by the colour of the relevant bar, and by the alarm status indicators.

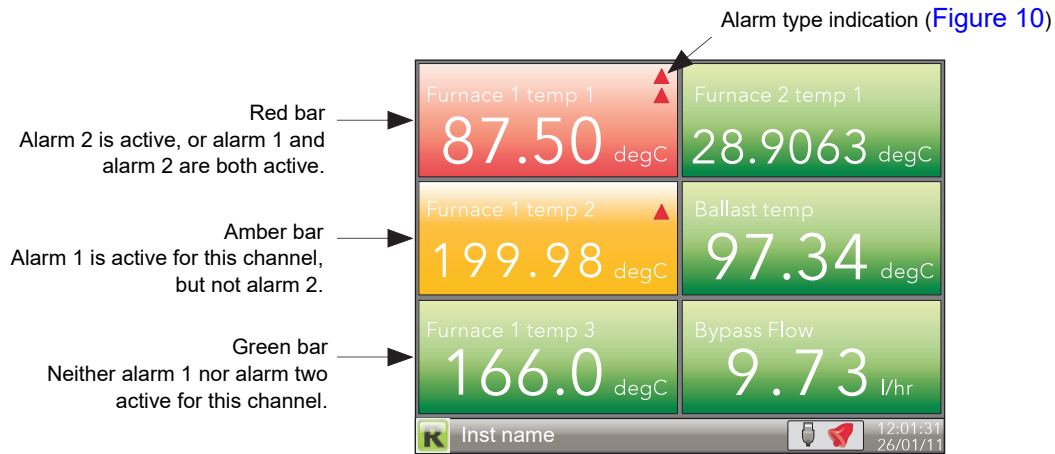

Figure 24 Alarm panel display (six channels)

The figure above shows an example where the Trend group contains six channels. [Figure 25](#) shows how the display appears for trend groups with fewer than six channels configured.

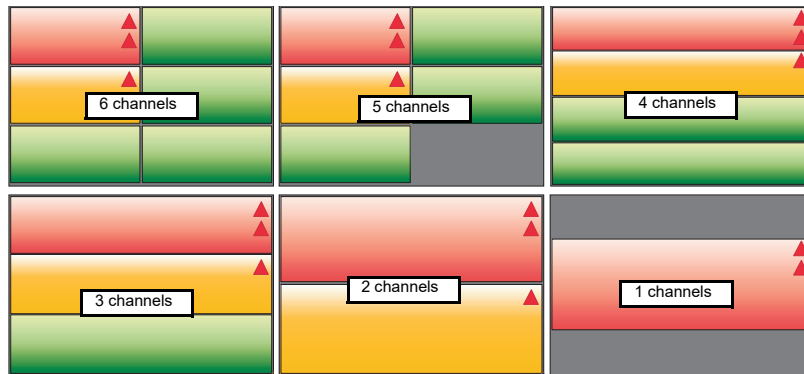

Figure 25 Alarm panel display layouts for trend groups with fewer than six channels

Control Loop1/Loop2

These displays appear only if the controller option is enabled ("Security menu" on page 98).

The loop display modes are interactive, in that the setpoint, the Auto/Manual mode and the Manual Output value can be edited from the user interface. Full configuration is carried out in the Loop setup menus ("Loop Option Configuration" on page 142) and a fuller description of control loops is to be found in "Appendix B: Control Loops" to this manual.

Figure 26 depicts a single loop display and the dual loop display. The up and down arrow keys are used as normal to scroll through Loop1, Loop2 and Dual loop pages.

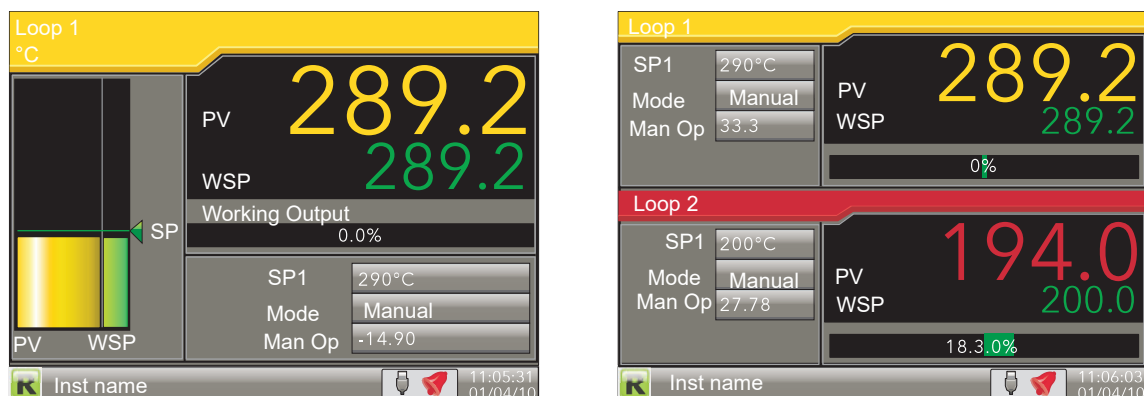

Figure 26 Loop displays

Note: The colours associated with the loops are those of the channels to which they are wired.

Editing Techniques

1. With the loop page on display, operate the Scroll key. This highlights the first editable item (SP1). The scroll order includes both loop1 and loop 2 parameters in the dual loop display.
2. Use the up and down arrow keys to select the required field for editing. When the required field is highlighted, operate the scroll key again, to enter edit mode.
3. Use the up/down arrows to edit the current setting.
4. Operate the scroll key to confirm the edit.
5. Select a further parameter for editing, or operate the page key to return to normal operation.

Note: Edit permissions for Setpoint, Auto/Manual and Manual Output Access are set in the Loop Setup configuration menu ("Setup menu parameters" on page 144). If the Auditor feature is enabled, user account permissions are set using the User accounts menu ("User Accounts (Auditor)" on page 107).

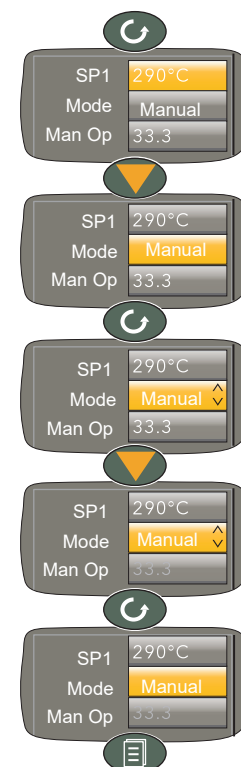

Cascade Display Mode

This display mode appears only if 'Cascade' has been enabled in the Instrument.Display area of configuration "Display configuration" on page 94). See also Advanced Loop configuration ("Advanced Loop Configuration" on page 152).

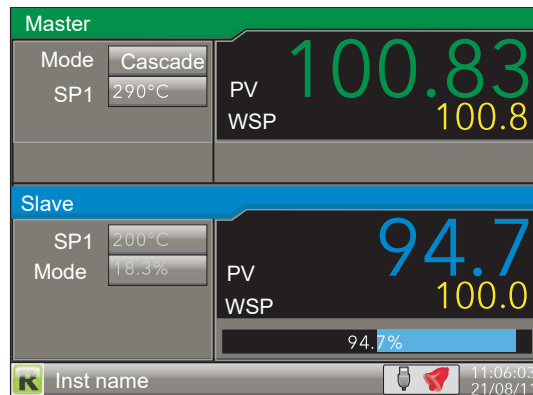

Figure 27 Single channel Figure 27 Cascade display mode

Operating the scroll button highlights the Master 'Mode' field. Operating the scroll button again, enters edit mode allowing the user to use the up/down arrow buttons to scroll through the available modes. Once the required mode appears, a further operation of the scroll button confirms the entry and quits edit mode.

Once out of edit mode, the down arrow key can be used to select Master 'SP1', Slave 'SP' and Slave 'Man OP'. The Mode selected determines how many of these items are editable by the operator.

Mode	Cascade: The master loop is in auto mode and provides the slave setpoint. Changing modes causes the slave to switch to the local slave setpoint. Slave: A simple single loop controlling with a local setpoint. Manual: Provides a single manual percentage power output.
SP1	Setpoint 1 is the primary setpoint of the controller. If the controller is in automatic control mode, then the difference between the setpoint and the process variable (PV) is continuously monitored by the control algorithm. The difference between the two is used to produce an output calculated to bring the PV to the setpoint as quickly as possible without causing overshoot.
SP	The slave setpoint, either local (Manual or Slave mode) in which case it can be edited, or supplied by the master loop (Cascade mode), in which case it is not editable.
Man.OP	The percentage output power to be applied when in Manual mode (100% = full on; 0% = off).

Note: Note: The default loop names ('Master' and 'Slave') can be replaced by user-entered strings of up to 10 characters in Advanced Loop Setup configuration ("Advanced Loop Setup menu" on page 154).

Programmer Display Mode

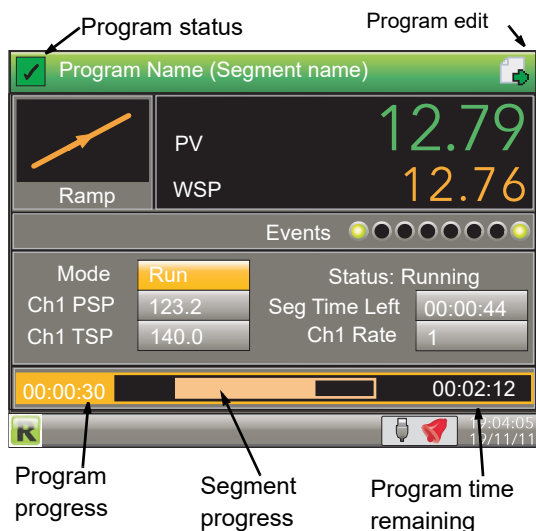

Figure 27 Double channel





Figure 28 Programmer displays (typical)

This display mode (if enabled - see "Display configuration" on page 94) allows the user to monitor the progress of a single or dual-channel setpoint program, and if logged-in as 'Operator*', to reset or run the program. The program itself is created in the Program edit page (described below) and in Programmer configuration ("Programmer Configuration" on page 171 or "iTOOLS").

Note: *Operator is the default access level - to edit, see 'Prog Mode Access' in "Programmer Setup menu" on page 175).

The displays contain the following features:

Program name	This is the name of the loaded program. If the program has been modified since being saved, an asterisk (*) appears after the name. Default background colour shown. This colour changes to that assigned to the input channel when this is configured.
Segment name	This is the name of the current segment. If not named in Segment configuration, then the segment number appears instead.
Program status	At the top right hand corner of the display, this can be any one of the following: <ul style="list-style-type: none"> <input checked="" type="checkbox"/> The program is running (or ran last time) without any PV 'Alarm' events or user intervention. <input type="checkbox"/> The user has intervened in the running of the program, by placing it in 'hold' or 'reset', or by advancing a segment, or by adjusting a duration, target setpoint, ramp rate or time-to-target value. <input type="checkbox"/> A PV 'Alarm' Event has activated. A PV 'Alarm' Event is an absolute high/low or a deviation alarm on the PV input. <input type="checkbox"/> There is no program loaded, or if a program is loaded, it has not yet run.
Program edit	<input type="checkbox"/> This icon appears for users with appropriate access permissions, to indicate that setpoint programs can be configured (as described in Program edit, below).
Segment type	For single channel displays, this indicates the type of segment currently being run:

	ration of the dwell period.
	 End (dwell). Displayed on completion of the program. The segment value remains at the final value until reset.
	 End (reset). Displayed on completion of the program. The program resets.
	 Ramp. The segment value ramps at a fixed rate or over a fixed period to the Target setpoint. Ramp up icon shown; ramp down is similar but inverted.
	 Step. The segment value switches immediately to the new Target setpoint. Step down shown; step up similar but inverted.
	 Wait. The segment value remains constant until the wait criteria are satisfied.
PV	The current process value of the signal wired to Ch1(2) PV Input. C
h1(2)PSP	This is the output setpoint from the programmer for the channel. In reset this value tracks the configured servo parameter.
Ch1(2)TSP	The channel target setpoint. The target setpoint may be edited while the program is in hold (in such cases, for ramp rate segments the time remaining is recalculated.
Events	Up to eight events can be configured in the Program Edit page. Any one or more of these events may be deemed to be active for the duration of each individual segment.
Mode	Shows the current run mode of the program. If the user has the correct access level, the mode can be set to 'hold', 'reset' etc. by using the scroll key twice (first to highlight the run mode, then again to enter edit mode) and then using the up/down arrow keys to select the required mode. Run, reset, hold etc. can also be selected by inputs from other parameters, switch inputs etc.
Status	Shows the status of the current segment.
Ch1 Rate	The channel 1 rate-of-change of segment value for 'Rate' ramp segments.
Ch1 Time	Shows the channel 1 duration configured for the segment to ramp, dwell etc. for 'Time' ramp segments. For two-channel programs, see the note below.
Seg Time Left	Shows the time that the segment has to run before completion.
Program progress	The numerals show program elapsed time, and the bar gives an indication of progress so far. For two-channel programs, see the note below.
Segment progress	For each segment as it runs, this gives a visual indication of the proportion of total segment time which has elapsed so far. For two-channel programs, see the note below.
Program time remaining	Shows the time remaining until the program completes. For two-channel programs, see the note below.

Note: Note: For two-channel programs, in 'Hold' mode, the 'program progress', 'segment progress' and 'program time remaining' areas of the display are replaced by 'Ch1 Time' and 'Ch2 Time', as shown below.



Figure 29 Two channel program in Hold mode

Program Run/Reset/Hold

Programs can be controlled by users with the correct access level (defined in Programmer configuration - "User Values" on page 225). The display page is placed in edit mode by operation of the scroll key ('Mode' highlights). A second operation of the scroll key followed by operation of the up/down arrows allows the user to select 'Run', 'Hold' or 'Reset'. A further operation of the scroll key initiates the selected action.

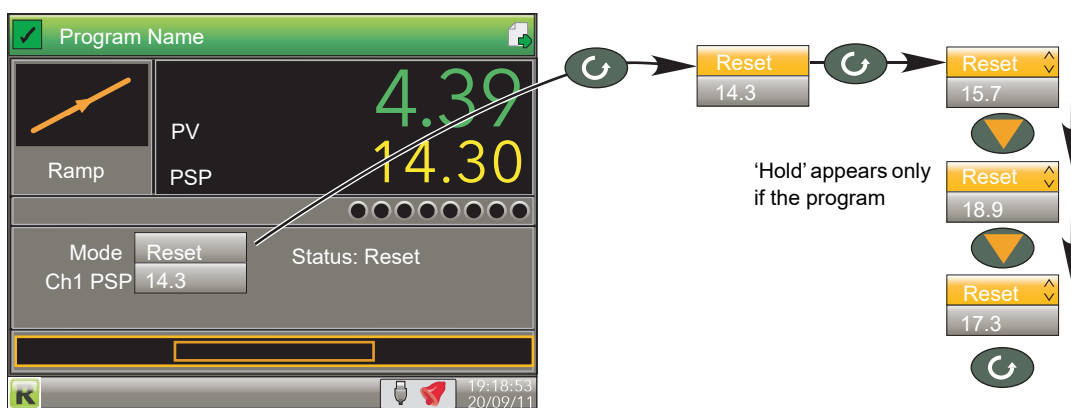

Figure 30 Setting the Mode

NOTES:

1. These functions can also be carried out by wiring relevant inputs to the 'Run', 'Hold' or 'Reset' parameters in Programmer configuration ("User Values" on page 225).
2. The user must have either 'Logged off', 'Operator' or 'Supervisor' level access as defined in 'Prog Mode Access' in the Programmer. Setup menu described in "Programmer Setup menu" on page 175. Alternatively, if the Auditor feature is enabled, a user with Program Mode permissions can also access the Programmer Mode. The program cannot run if the unit is logged into at 'Engineer' level.

Program Editing

The program edit page is accessed by operating the scroll button once to highlight the Mode, then using the up arrow key to highlight the page symbol at the top right hand corner of the display and then the scroll button again to enter the program editor.

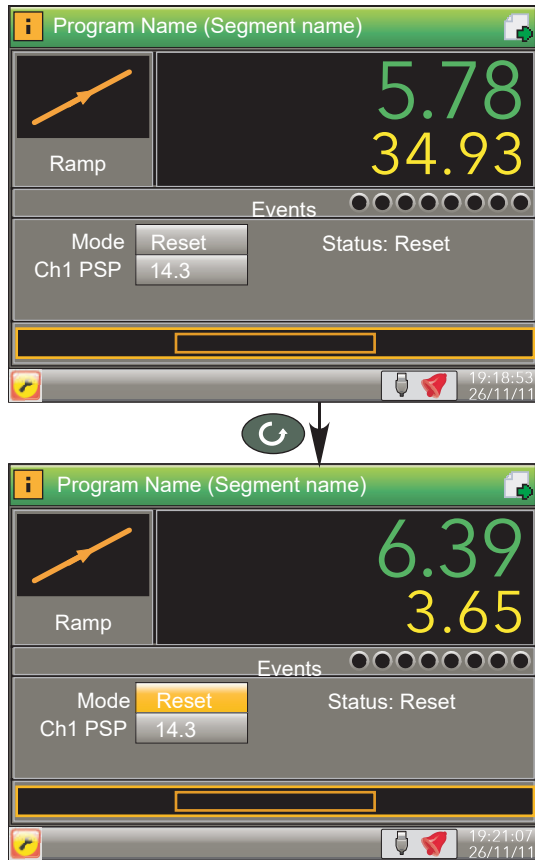

By default, Program Edit is available only to users with Supervisor or Engineer level access. The required access level can be edited in Programmer. Set Up configuration as described in "Programmer Setup menu" on page 175.

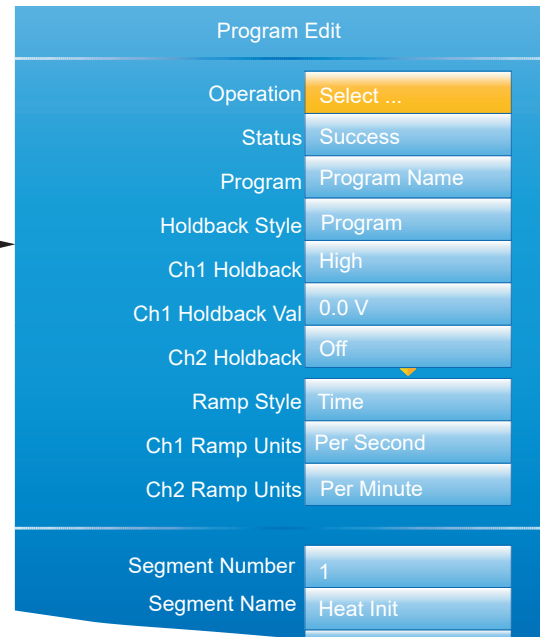

Figure 31 Access to the program editor

As can be seen from the figure above, the initial Program Edit page is divided into two areas - the top part contains program details; the lower part (Figure 33) contains individual segment details. The editable items that appear in the program details area depend on the features enabled in the Programmer Features configuration menu ("Programmer Features menu" on page 172).

Note: Access to some program operations is restricted to users with the correct access level, as defined in the 'Prog Mode Access', the 'Prog Edit Access' and the 'Prog Store Access' parameters in the Programmer. Set Up area of configuration described in "Programmer Setup menu" on page 175. Alternatively, if the Auditor feature is enabled, individual users can be assigned access to the Program Mode, Program Edit and Program Store functions. Access to some items also depends on whether or not the program is running.

Program Details

Operation

This allows the user to select one of the following (see also 'Program Store', below): Load. Opens the program store and allows the user to select a program to be loaded. The program must have the same number of channels as defined in Programmer.Set Up ("Programmer Setup menu" on page 175).

Store. Allows the current program to be saved to the internal program drive. This is useful if you wish to snapshot the current program and store this under a different program name.

Delete All. Deletes all programs.

Copy. Copies the selected program for 'pasting' either from the internal drive to the USB device, or *vice-versa*. This is useful if you need to transfer a program to other nanodac instruments.

Copy All. As above, for 'Copy', but copies all the programs in the selected directory.

Note: If a 'Store', 'Copy' or 'Copy All' operation would result in there being a total of more than 100 program files in the internal drive, the operation fails and an error message is displayed.

Status	Success. Previous operation was successful. Failed. Previous operation failed. Loading. The program is loading. Copying. The program copy process is underway. Deleting. The relevant program is being deleted.
Program	The name of the program currently loaded.
Holdback Style	Appears only if 'Holdback' is enabled in the Programmer Features configuration ("Programmer Features menu" on page 172). See also 'Holdback', below. Program: Holdback applies to all appropriate segments. Per Segment: Holdback enabled on a segment by segment basis as described in 'Segment Configuration' below.
Ch1 Holdback	Appears only if 'Holdback Style' (above) is set to 'Program'. Off: Holdback is disabled. Low: Holdback is entered when $PV < (PSP - Holdback Value)$. High: Holdback is entered when $PV > (PSP + Holdback Value)$. Band: Holdback is entered when $PV < (PSP - Holdback Value)$ or $PV > (PSP + Holdback Value)$.
Ch1 Holdback value	The value to be used in triggering holdback.
Ch2 Holdback	As for Ch1 Holdback, above but for channel 2. Appears only if 'Channels' is set to '2' in Programmer Set Up configuration ("Programmer Setup menu" on page 175).
Ch2 Holdback value	As for 'Ch1 Holdback value', above, but for channel 2. Appears only if 'Channels' is set to '2' in Programmer Set Up configuration ("Programmer Setup menu" on page 175).
Ramp Style	Ramp style applies to all ramp segments in the program. Ramp Style can be edited only when the program is in Reset mode. Setpoints, rates, times etc. are set in the individual segment configurations. Rate. A Ramp Rate segment is specified by a target set-point and the rate at which to ascend/descend to that set-point. Time. A Ramp Time segment is specified by a target set-point and a time in which to achieve that set-point.
Ch1 Ramp Units	Select 'Per Second', 'Per Minute' or 'Per Hour' for ramp timing units. Ramp Units can be edited only when the program is in Reset mode.
Ch2 Ramp Units	As for 'Ch1 Ramp Units' above. Appears only for two channel programs and allows different ramp units to be selected for the two channels, if required. Ramp Units can be edited only when the program is in Reset mode.

Holdback

Holdback pauses the program (freezes the Programmer setpoint (PSP) and the time remaining parameters) if the difference between the Process value (PV) and the PSP exceeds a user-specified amount (Holdback value). The program remains paused until the PV returns to within the specified deviation. In ramp or step segments, holdback indicates that the PV is lagging the SP by more than the specified amount and that the program is waiting for the process to catch up. In a dwell segment, holdback is used to guarantee that a work piece stays at set-point within a specified tolerance for the specified dwell duration.

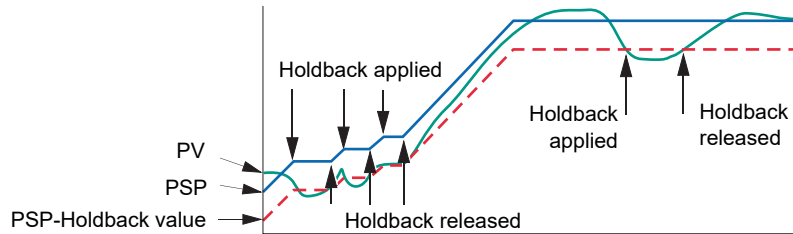

Figure 32 Holdback

Segment Configuration

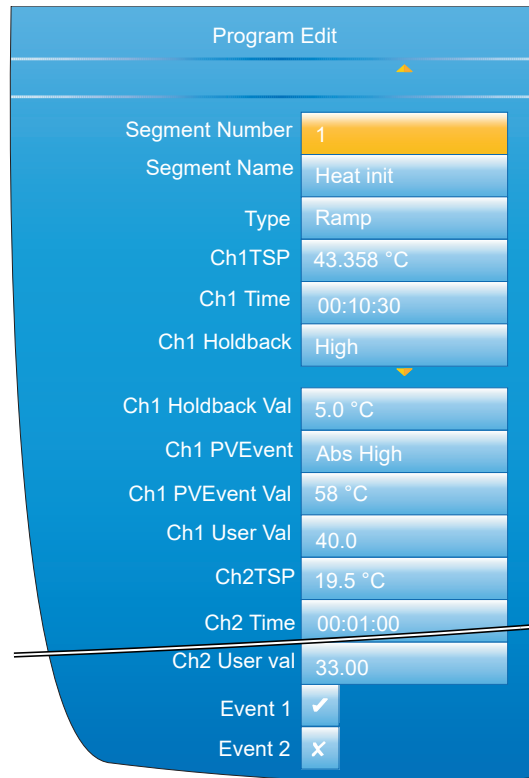

Figure 33 Segment configuration

- Segment Number Select the relevant segment for configuration.
- Segment Name Enter a segment name of up to 20 characters. This name will be truncated on the display page if it, together with the program name, are too long to fit the width of the display area.
- Type Select a segment type. Default is 'End'. Ramp. For any program, Ramp segments can be either 'Ramp Rate' segments or 'Ramp Time' segments accord-

'Ch1(2) Time' or 'Ch1(2) Rate', below.

Dwell. The setpoint is maintained at its current value for the period defined in 'Duration' (see below).

Step. A step segment allows a step change to be entered for the target set-points Ch1 TSP and Ch2 TSP.

Wait. A wait segment causes the program to wait for a certain event to occur before continuing. See 'Wait For', below.

Go Back. A Go Back segment allows a specifiable number of iterations to be performed of a group of segments. This could be used, for example, to cycle an entire program by having a Go Back segment immediately before the end segment and specifying segment 1 as the 'Go Back To' point. Setting 'Cycles' to 'Continuous' causes the program to loop indefinitely, until interrupted by the user. 'Nested' loops are not permitted i.e. 'Go Back' is not available as a segment type for segments inside an existing GoBack loop.

End. The final segment of a program allows the user to select 'Dwell' or 'Reset' as the action to be taken at the end of the program (see 'End Type', below).

Ch1(2) TSP	Target setpoint. The value that Ramp or Step segments seek to attain, for channel 1(2).
Ch1(2) Rate	For Ramp Rate segments, this specifies the speed at which the process value ramps towards the target, for Channel 1(2). The ramp units (per second, per minute, per hour) are set in Ch1(2) ramp units described above.
Ch1(2) Time	For Ramp Time segments, this allows the user to specify the time to be taken by the segment for the process value to reach the target.
Duration	For Dwell segments, this allows the entry of the time for which the segment dwells.
Go Back To	For 'Go Back' segments, this defines the number of the segment to which the program is to return.
Cycles	The number of times the 'Go Back' instruction is to be carried out. If set to 'Continuous', the program continues until the user intervenes to stop it.
End Type	Allows the user to select the action to be taken at the end of the program: Dwell: the set-point is maintained indefinitely and event outputs remain at their configured state. Reset: the set-point reverts to the value used by the control loop before the program was started and the event outputs return to their default states.
Wait For	Digital High: Wait segments can be configured to wait for 'Wait Digital' to go 'high' before allowing the program to continue. Analog 1(2): The segment waits for 'Wait Analog1(2) to meet an Absolute High or Low, or Deviation High or Low condition before allowing the program to continue. Analog Both: As Analog 1(2) above, but waits for both Channels' conditions to be true before continuing.

Note: 'Wait Digital', 'Wait Analog 1' and 'Wait Analog 2' parameters are configured in the Programmer.Set Up menu described in "Programmer Setup menu" on page 175.

Ch1 Wait	Select 'Abs High', 'Abs Low', 'Dev High' or 'Dev Low' as the wait criterion for channel 1. Appears only if 'Wait For' (above) is set to 'Analog 1' or 'Analog Both'.
Ch2 Wait	Select 'Abs High', 'Abs Low', 'Dev High' or 'Dev Low' as the wait criterion for channel 2. Appears only if 'Wait For'

Ch1(2) Wait Val	Enter the trigger value for 'Ch1(2) Wait'.
Ch1(2) Holdback	Select 'Off', 'Low', 'High', or 'Band' (see description in Program Details, above).
Ch1(2) Holdback Val	The value to be used in triggering holdback.
Ch1(2) PV Event	<p>Appear only if 'PV Events' have been enabled in the Programmer Features menu ("Programmer Features menu" on page 172). A PV Event (an analogue alarm on the channel PV) is available for each channel in every segment (excluding Wait and Go Back segment types). The following PV Events are supported:</p> <p>Off: The PV Event is disabled.</p> <p>Abs High: The event is triggered when the channel PV exceeds PVEvent Val for the relevant channel.</p> <p>Abs Low: Triggered when the channel PV becomes less than PVEvent Val for the relevant channel.</p> <p>Dev High: This event is triggered when the channel PV exceeds (PSP + PVEvent Val) for the relevant channel.</p> <p>Dev Low: Triggered when the channel PV becomes less than (PSP - PVEvent Val) for the relevant channel.</p> <p>Dev Band - This event is triggered when the channel PV differs from the PSP by more than the configured deviation value (either above or below).</p> <p>In the following example, in segment 1 Ch1 PV Event has been configured as Dev Band and in segment 2 it has been configured as an Abs low:</p>

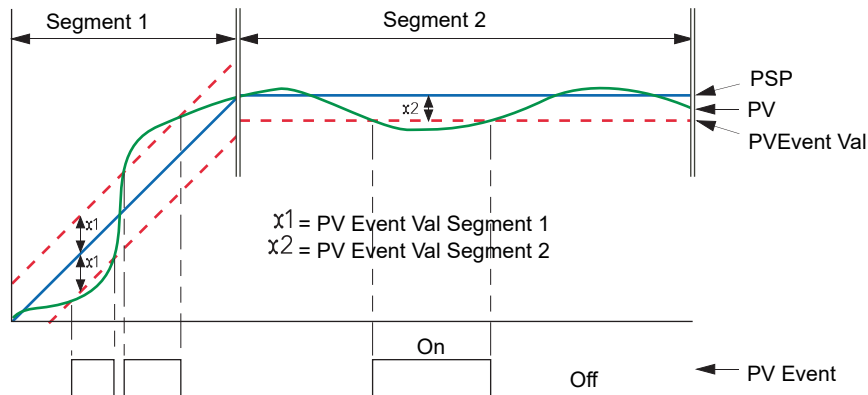

Figure 34 PV Events

Ch1 PVEvent Val	Appears only if 'Ch1 PVEvent' is not 'Off'. Sets the level at which Ch1 PV Event becomes active.
Ch2 PVEvent Val	Appears only if 'Ch2 PVEvent' is not 'Off' and if 'Channels' is set to '2' in Programmer Set Up configuration ("Programmer Setup menu" on page 175). Sets the level at which Ch2 PV Event becomes active.
Ch1 (2) Event Use	When PV events become active, they can be used either to Trigger a secondary process or as a simple analogue alarm on the PV input. Appears only if the relevant PV Event parameter is not set to 'Off'.
Ch1 (2) User Val	<p>Specifies the User Value for this segment, for channel 1(2). Appears only if 'User Value' has been enabled in the Programmer Features menu ("Programmer Features menu" on page 172).</p> <p>The example below (from iTools) shows this parameter wired to the trigger 1 input of the Custom Messages block, so that, if a User value >0 is entered, then every time the segment runs, Custom message 1 is generated.</p>

Event 1 to 8

The number of Events available (Max Events) is defined in Programmer Set Up configuration ("Programmer Setup menu" on page 175). Enabling an event causes the relevant indicator on the display page to be illuminated for the duration of the segment. As with 'User Val', above, Events can be wired to the inputs of other parameters if required.

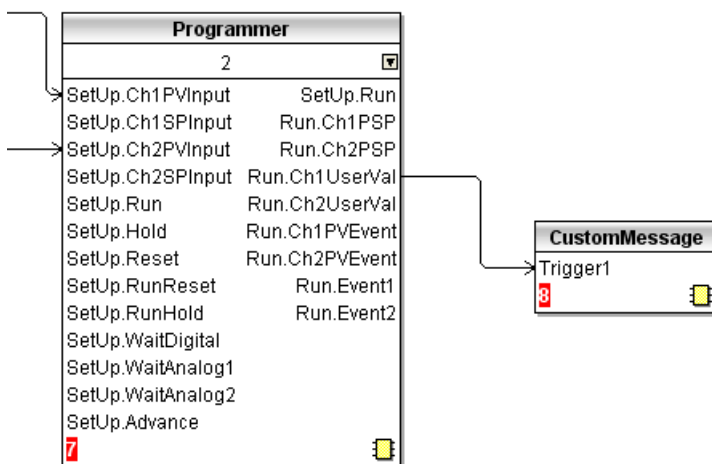

Figure 35 iTools example showing Ch1 UserVal being used to trigger custom message 1.

Future Trend Display Mode

If enabled in Instrument.Display configuration ("Display configuration" on page 94), this allows the user to view the actual value of the PSP alongside the expected value, so the two can be compared to see how the process is performing. Future trend is an enhancement of the horizontal trend mode, with the display being divided into two parts, with the instantaneous current value located at the divide, with past trends to the left and the next few program segments to come, to the right.

NOTES:

1. For the future trend mode to appear, the programmer must be wired to the loop or advanced loop feature.
2. Both historic and future trends move from right to left with the present anchored at the screen centre.
3. The amount of history and of future trending displayed on the screen depends on the trend interval set in Group.Trend configuration ("Group Trend configuration" on page 117).

Figure 36 shows a typical future trend display.

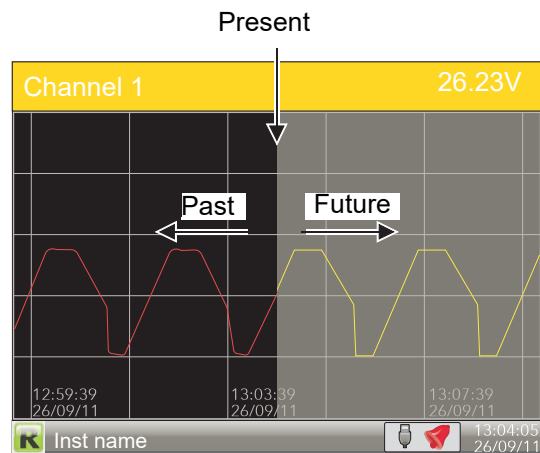

Figure 36 Future trend display

Program Store

Note: The access levels required for the operations described below are configured in the Programmer Set Up menu ‘Prog Edit Access’ and ‘Prog Store Access’ parameters, described in "Programmer Setup menu" on page 175.

The program store allows access to the instrument’s local program storage area and to programs stored on a USB memory stick (if any) and to those stored in a PC (if any), via FTP. Programs may be saved to (Stored) or retrieved from (Loaded) from the program store, or they can be copied or deleted. Selecting any of the program operations (except ‘Delete All’), from the Program Edit page (Engineer access level required) opens the file explorer page. "Program store display" on page 68 depicts this page, with just a couple of example entries after a ‘Load’ operation has been requested. On entry, use the up/down arrow button to select ‘User’, ‘USB’ or ‘FTP’ (selection highlights yellow), then use the scroll button to confirm. Use the up/down arrow buttons to select the required file, and then use the scroll button again to confirm. Other operations are similar.

The file explorer supports 100 entries, which may be directories or files.

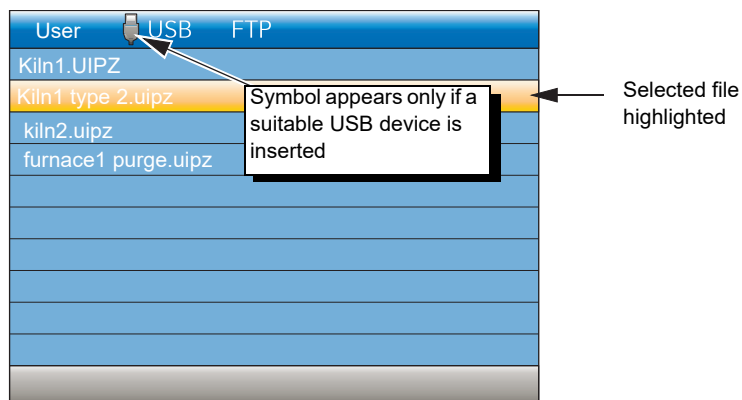

Figure 37 Program store display

Note: A ‘busy’ icon (rotating green flash) appears whilst directory listings are being accessed.

Program Load - Quick Access

From firmware version V5.00 and above a quick selection of an internally stored program may be made directly from the Program Summary page. The programmer must be in Reset. Press and hold the scroll key for two seconds. The page will go immediately to the file explorer page with the 'User' drive selected and the 'Operation' parameter set to 'Load'. The first program file will be selected (assuming different programs have been configured). Use the Up/Down keys to select the required program followed by the scroll key to load it.

If the selected file cannot be loaded (for example, the programmer file is for a different number of channels) then an error message is shown on the file explorer. The Quick Access to load mode adheres to the access security settings set in configuration mode - Programmer set up ("Programmer Setup menu" on page 175).

Note: Quick load is disabled when in Edit mode. This is indicated by the highlighted parameter showing the raise/lower symbol to the right of its value.

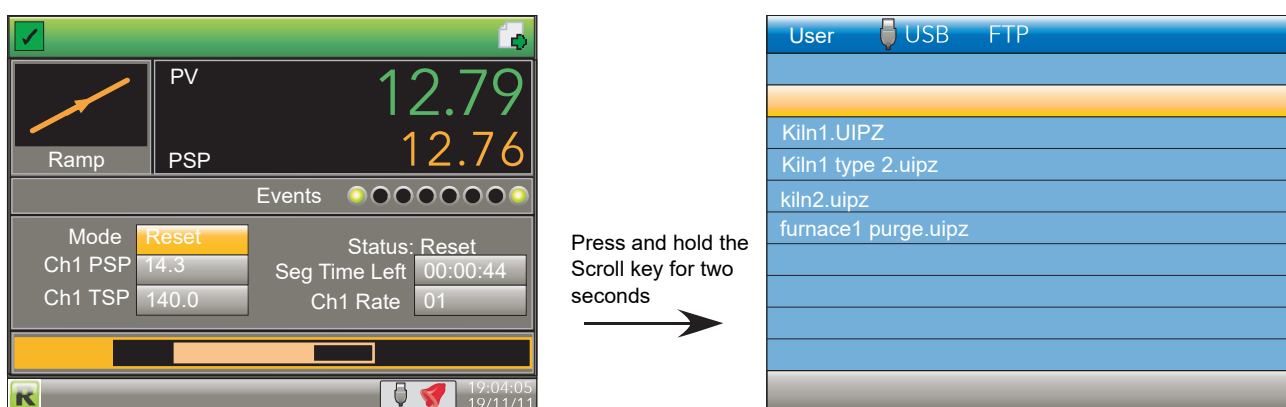

Figure 38 Program load display

Program Load via a Program Number

This feature has been added to firmware versions V5.00 and above. To allow a program (stored as a file) to be loaded, either via a BCD switch, wired to a set of digital inputs, or via a single comms transaction, it is necessary to prefix the program name with a program number in the range 01 to 99. For example, 01kiln1.uipz, 01furnace.uipz, 02kiln2.uipz, 03kiln3.uipz etc. The program name can consist of up to 18 characters. Note that program numbers 1 to 9 must be entered as 01 to 09 otherwise they will not be recognised by the switch or via comms. On value change of the program number, the first program file with the prefixed number in the instrument's internal User drive (listed lexicographically) will be loaded. In the above example if program 01 is selected, 01furnace.uipz will be loaded, 01kiln1.uipz will not be loaded using the BCD switch or through comms. It can, of course, be loaded manually.

If no program number is prefixed it is not possible to load the program via the BCD switch or via comms. It is, however, still possible to load the program by selecting the file as described in the previous section.

Note: When a BCD switch is turned from its current value to another value, intermediate switch positions may be seen on the inputs of the BCD function block and could potentially be used by subsequent blocks wired from the BCD input. A Settle Time parameter has been introduced which will in effect filter out these intermediate values by applying a time in which the inputs can settle before their converted decimal value is seen on the output parameters of the block. The Settle Time can be set from 0-10 seconds with a default of 0s i.e. no filtering as in previous firmware versions. The BCD block is described in "BCD Input" on page 214.

Example BCD Switch Wiring

Figure 39 shows an example of digital input channels soft wired to the BCD function block using iTools.

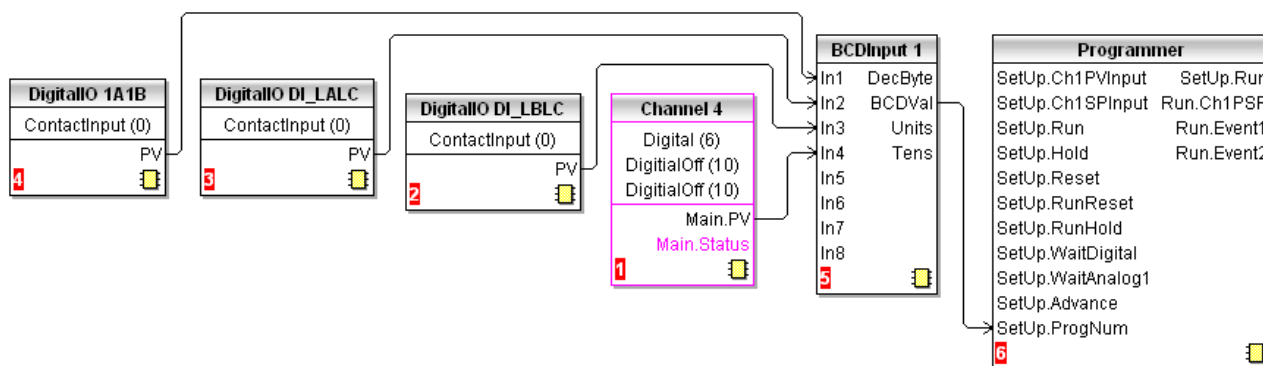

Figure 39 BCD Switch Wiring

Figure 40 shows the corresponding hard wiring of a BCD switch.

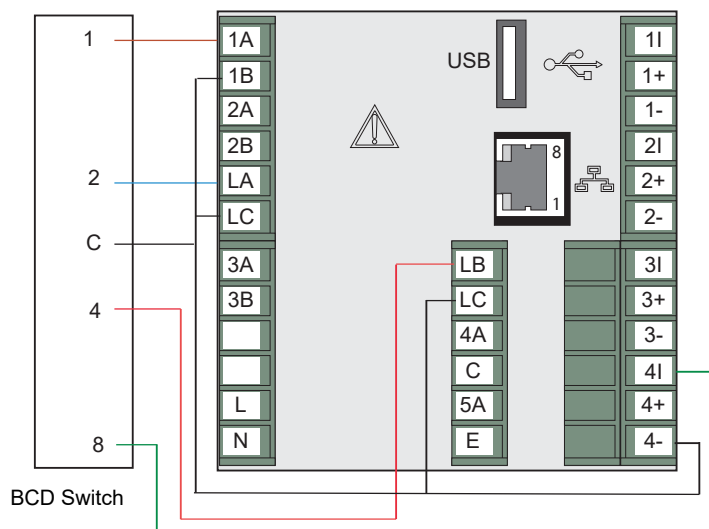

Figure 40 BCD Switch Physical Wiring

Steriliser Display Mode

This display mode appears only if the Steriliser option is fitted and if the display mode has been enabled in the Instrument Display configuration ("Display configuration" on page 94). Steriliser configuration parameters are to be found in "Configuration parameters" on page 204.

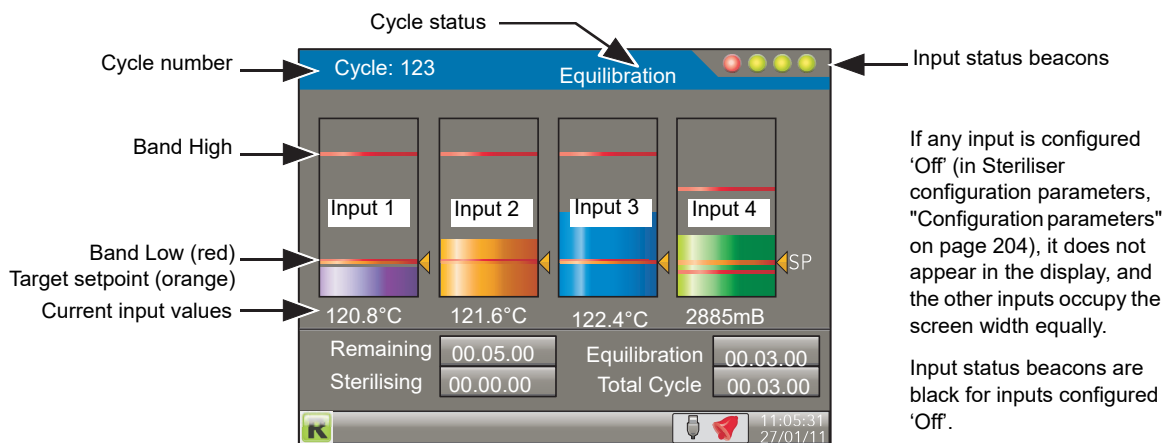

Figure 41 Steriliser display mode (typical) (four inputs)

Operation

A sterilising cycle cannot be initiated whilst the unit is in Configuration (Engineer) mode. A steriliser cycle is started by setting its relevant 'Start' input to 'Yes' for the duration of the cycle. The cycle waits (status 'Waiting') until input 1 reaches its setpoint, at which point the cycle enters the equilibration period (status 'Equilibration'), and remains there until all the configured inputs are valid. The cycle then enters the sterilising period and stays in this mode until the sterilising period has expired (status 'Passed') or until one of the inputs becomes invalid (status 'Failed') for longer than its configured 'Failure Dwell' time.

Note: The cycle stops (status 'Failed') if the trigger source is removed.

Terminology

Holding time	Most operating cycles have a stage in which the load must be exposed to sterilisation conditions for a specified length of time, known as the 'Holding time'.
Equilibration time	The holding time (above) is preceded by a period during which, although the sterilising condition is present in the chamber, the load has not yet attained that temperature due to its thermal inertia. 'Equilibration time' is defined as the time between the attainment of sterilisation temperature in the chamber, and the attainment of that temperature in all parts of the load.
Bands	For steam and dry heat sterilisers, sterilisation conditions are specified by a sterilisation temperature band, defined by a minimum acceptable temperature (known as the sterilisation temperature) and a maximum allowable temperature. A sterilisation band is normally quoted for each steriliser type.

Beacons

There are four input status beacons near the top right hand corner of the display, one for each input. During equilibration, the beacons are flashing red for inputs that have not attained the Target setpoint, and go green when the target setpoint is reached, remaining green even if the input value rises above the Band High value. The beacons revert to red if input falls below* the target setpoint. During sterilisation, the beacons go red for any input whose value rises above Band High or falls below* setpoint for a duration exceeding the configured 'Failure Dwell' period. Beacons are black for inputs that are configured as 'Off'.

* 'rises above' for input types 'Falling Pressure' or 'Fall Air Detect'.

Displayed Information

Cycle	A five-digit counter to indicate the total number of cycles started.
Status	Wait start: The initial state at power up. This status remains until the first cycle is initiated. Waiting: Waiting for input 1 to reach its target setpoint. The cycle then enters Equilibration. Equilibration: Currently in the equilibration period, during which the cycle waits until all inputs have reached sterilisation conditions. Sterilising: Currently in the decontamination phase. Passed: The cycle has completed successfully. Failed: The cycle has failed either through one or more inputs becoming invalid, or because the 'Start' signal was removed. Test cycle: A test cycle is in progress.
Remaining	The sterilising time remaining for the current cycle. Display field is replaced by 'Target Time' (below) when the cycle is not running.
Target time	The intended sterilisation time. This can be configured by operating the scroll button twice (once to highlight the field, and again to enter edit mode), and then using the up and/or down arrows to edit the time. Use the Scroll button again to quit edit mode, and the page key to 'unhighlight' the field. Replaced by 'Remaining' (above) when the cycle is running.
Equilibration	The equilibration time period for the current cycle.
Sterilising	The time for which the load has currently been at sterilisation conditions.
Total Cycle	The elapsed time since the initiation of the current cycle. This time increments from the time the cycle is triggered until the time the trigger is removed.
Input values	Temperature are required in °C; pressure inputs in mBar. If necessary, maths channels and user values can be used to convert from other units (see 'Note' overleaf).

Sterilising Cycle Diagram

Figure 42 shows a steriliser cycle in diagrammatic form.

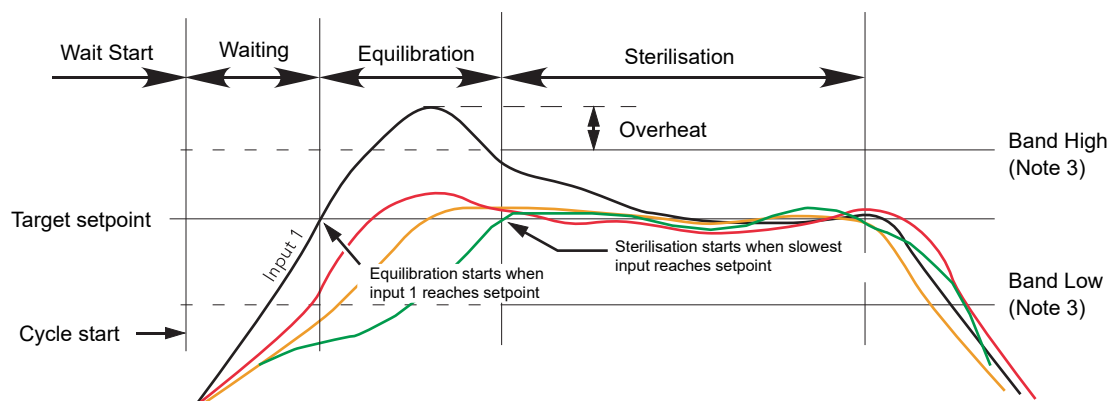

Figure 42 Steriliser cycle

NOTES:

1. For temperature inputs in most applications, the Setpoint value is the same as the Band Low value. For the sake of clarity, this is not as shown in the figure above.
2. For the sake of clarity all four inputs in the figure above are shown with the same Band High, Band Low and Setpoint value. This would not be unusual for temperature units, but the pressure input would normally have a different set of values from temperature inputs.
3. Band High and Band Low are effective only during Sterilisation phase.

Application Details

Figure 43 shows a typical steriliser application, with temperature and pressure signals from the sterilisation chamber being applied directly to the rear terminals of the controller/recorder, and control signals connected from the controller to both the chamber and the controller/recorder.

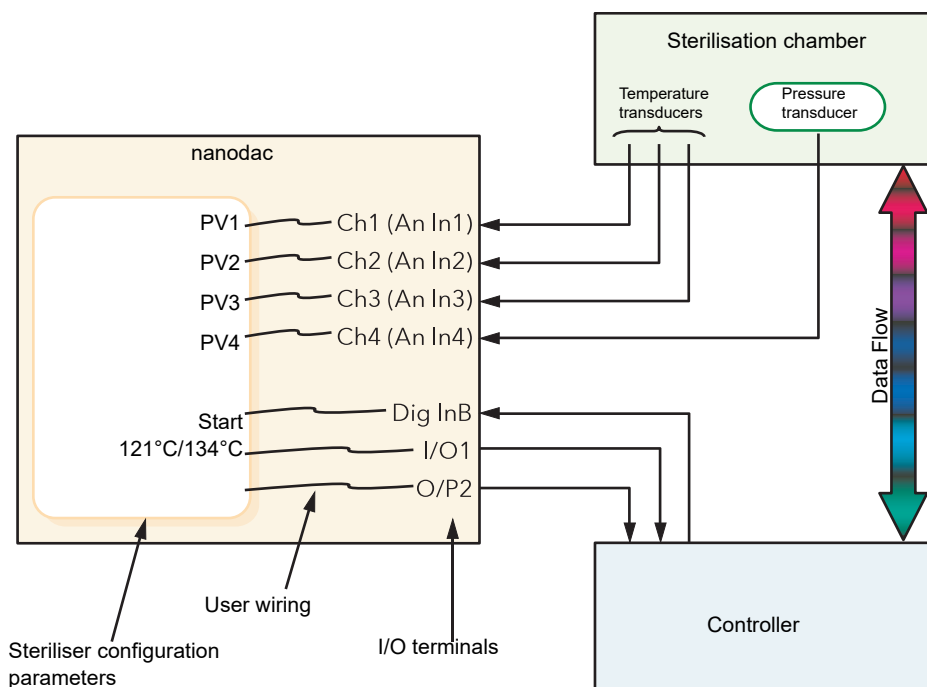

Figure 43 Typical steriliser application

Analogue inputs 1 to 3 receive signals from temperature transducers (typically thermocouples) within the chamber. These inputs are internally connected to channels 1 to 3 respectively, allowing transducer type, ranges, alarms, etc. to be configured ("Input Channel Configuration" on page 123). Inputs are assumed to be degrees Celsius (see Note).

The pressure transducer is connected to channel 4 and can be configured in the same way. The input is assumed to be in milliBar. Other pressure inputs should be converted using virtual channels (see Note).

PV1 to PV4 in the Steriliser configuration is software wired (Section 9) to Ch 1 to Ch4.

Start cycle input and the 'Running Output' and 'Passed Output' signals are software wired to suitable DIO terminals, for connection to the Controller.

Note: For Fahrenheit inputs, use one virtual channel to subtract 32, and a second to divide the result by 1.8 (where 32 and 1.8 can be configured as user values). Similar techniques should be used to convert pressure input units if necessary.

Test Cycles

A 'Test' cycle is initiated by initiating a 121°C cycle and a 134°C cycle simultaneously. A test cycle allows the user to check actual performance against expected performance.

F₀

F₀ is a means of calculating 'equivalent time at sterilising temperature' for temperatures below, at and above sterilizing temperature, using the equation below.

$$F_0 = \text{Sterilisation time} \times 10^{\frac{\text{Temp} - T_s}{Z}}$$

Where:

Sterilisation time	Depends on the application, typically 15 minutes at Ts = 121°C
Temp	The value of the temperature measuring input.
Ts	Desired Sterilising temperature.
Z	Temperature interval representing a factor-of-10 reduction in killing efficiency. Z = 10 for steam sterilising (F0), or Z=20 for dry heat sterilising (FH). Z = 10 for thermal disinfection (A0).

To ensure that steriliser loads which contain materials with different thermal inertias are thoroughly sterilised, a number of sensors are located within the load. The F value should be calculated using the sensor closest to that part of the load which has the highest thermal inertia. For maximum accuracy, the temperature sensor should be calibrated and the input adjust function used to compensate for any inaccuracy found.

F0 calculation examples

For all the examples following, the following are assumed: Sterilisation time = 15 minutes; Sterilisation target temperature = 121°C and Z = 10.

1. For an actual sterilising temperature of 111°C.

$$F_{val} = 15 \times 10^{\frac{111 - 121}{10}} = 15 \times 10^{\frac{-10}{10}} = 1.5 \text{ minutes}$$

Which means that 15 minutes at 111°C is equivalent to 1.5 minutes at 121°C.

- For a sterilising temperature of 121°C.

$$Fval = 15 \times 10^{\frac{121-121}{10}} = 15 \times 10^{\frac{0}{10}} = 1.5 \text{ minutes}$$

Which means that the sterilising temperature is ideal (by definition).

- For a sterilising temperature of 124°C.

$$Fval = 15 \times 10^{\frac{124-121}{10}} = 15 \times 10^{\frac{3}{10}} = 15 \times 1.995 = 29.925 \text{ minutes}$$

Which means that 15 minutes at 124°C is equivalent to nearly 30 minutes at 121°C.

Normally sterilising temperatures would not remain constant at temperatures below or above the target value, so the above equations are illustrative only of the facts:

- Temperatures below the target have some killing efficacy.
- Temperatures above the target value have a greater killing efficiency, so that the sterilising time can be reduced.

In order to calculate the value dynamically, the instrument uses the equation:

$$Fval_t = Fval_{t-1} + T \times 10^{\frac{mat - Targettemp}{Z}}$$

where

Fvalt	= F value this iteration
Fvalt-1	= F value last time
T	= Iteration period (minutes)
mat	= input temperature value this iteration
Target Temp	= 121°C for F0, 170°C for FH, 80°C for A0
Z	= 10°C for F0, 20C for FH, 10°C for A0

Batch Summary

This display page shows the user a summary of the current, or last run (if no batch is currently running), batch. Access to the Batch Control page is available through this page if the logged in user has sufficient permissions; otherwise the Batch Summary page is display-only. The page shows basic information about the batch including whether a batch is currently active, the customised Field 1 descriptor and value, start date and time and the batch run duration.

Page icon only visible if logged in user is the Supervisor or has Batch permissions.



← Page icon only visible if logged in user is the Supervisor or has Batch permissions.

Figure 44 Batch summary page

Batch Control

If the logged in user is the Supervisor or has Batch permissions, the page icon appears at the top-right of the display. This provides access to the Batch Control page where a batch can be initiated, started or stopped. To access the Batch Control page, press the scroll button twice (the first press highlights the page icon, and the second press enters the page). An example Batch Control page is shown in [Figure 45](#).



Figure 45 Batch control page

- Batch Active Read-only parameter showing the current running state of the batch -either 'Yes' (active) or 'No' (inactive).
- Batch New When set to 'Yes', initialises a new batch and resets all the Batch Descriptor values to the default values (see "Batch Configuration" on page 119). Any Batch Descriptor fields which require user input are set blank and must be completed before a batch can be started using the Batch Start parameter. This field can only be changed if no batch is currently active.
- Batch Descriptor {n} Up to six user-definable text values which are pre-configured (see "Batch Configuration" on page 119) and written to the log on batch initialisation, batch start and batch stop (according to configuration rules). Batch field 1 can be configured to automatically populate with the current PV value. These fields are only editable if the Batch New field is set to Yes and the batch hasn't yet been started.
- Batch Start Set to 'Yes' to start the batch. This field can only be set to 'Yes' if a batch has already been initialised and the re-

Batch Stop

Set to 'Yes' to stop the current active batch. This field can only be set to 'Yes' if a batch is currently active.

Promote list

This display page allows the user to display up to 10 of the parameters that appear anywhere in the operator interface. The parameters can be selected only by using iTools, as described below.

NOTES:

1. 'Promote List' must be enabled (in 'Instrument.Display' configuration), before it appears in the 'Go to View' list.
2. There are more parameters visible in iTools than appear at the operator interface. If non-operator interface parameters are selected for inclusion in the promote list, they do not appear.
3. If parameters which appear only in certain circumstances are selected, then they appear in the promote list only when they appear in the Operator interface. For example, a channel PV is not visible unless that channel is enabled (i.e. it is not 'Off').

Parameter Selection

1. Open iTools and scan for the instrument, (see "iTOOLS").
2. Once the instrument has been found, stop the scan. When the instrument has synchronised, click on the 'Access' button near the top of the display to set the unit into configuration mode (a password may be required).
3. Click on the '+' sign to the left of the Instrument folder in the tree list (left-most pane) to expand the folder. Double-click on 'Promote List', to display the Promote list in the main pane. The list contains 20 entries, 1 to 10 being for parameters, 11 to 20 being available to the user to add descriptors for parameters 1 to 10 respectively.
4. Expand further folders, as necessary, to access the required parameters, and click-drag these parameters into the promote list. Enter a descriptor for the parameter if the default is not as required. As each parameter is dragged into the list, it appears in the Promote list.
5. If the parameters are modified at the operator interface, the changes are reflected in iTools, and vice-versa.
6. Once all the parameters have been added, it is recommended that the Access button be used to quit configuration mode, as otherwise it will not subsequently be possible to quit from the operator interface.

Figure 46 shows typical displays.

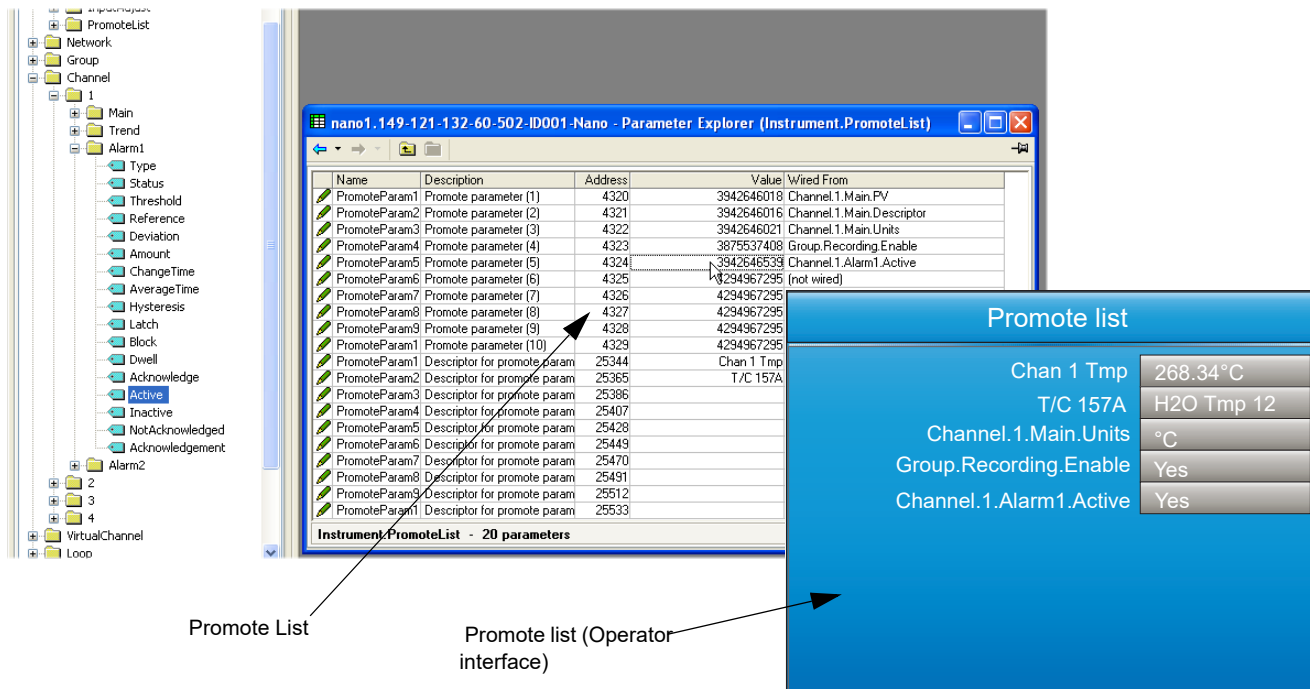

Figure 46 Promote list displays.

Modbus Master display mode

This display mode consists of two pages, as shown in Figure 47.

Page one opens by default and shows the first eight parameters being read from (left pointing arrow) or written to (right pointing arrow) the relevant slave. These items are configured in the Modbus Master configuration described in Section 6.10. Hidden parameters may be viewed by operating the scroll key, then using the arrow keys to scroll through the list. A green arrow means that the item may be edited by the user when logged in. A pair of animated indicators in the top left-hand corner of the screen show the connection status of the two possible slaves. A green moving 'streak' indicates that successful communications are being carried out. A red flashing circle indicates that there is a break in the transmission line or that the slave is switched off. A grey, non-animated display indicates that the slave has not yet been configured as a part of the communications link (i.e it is 'off line').



A 'traffic light' indicator appears to the right of each parameter. Green indicates that the parameter is being read from or written to successfully. Orange indicates that a write of the value is pending. Red indicates that there is an error and that no value is currently being read or written; the value displayed is the last good value read or written depending on whether the data item is a read or write. If the indicator is black, the parameter is 'off'.

Operation of the scroll key highlights the page symbol in the top right-hand corner of the screen, and a further operation of the scroll key calls page two to the screen.

Page two contains the IP address of the Modbus master and of any slaves connected to it, together with some diagnostic information, as described in 'Ping Details', below.

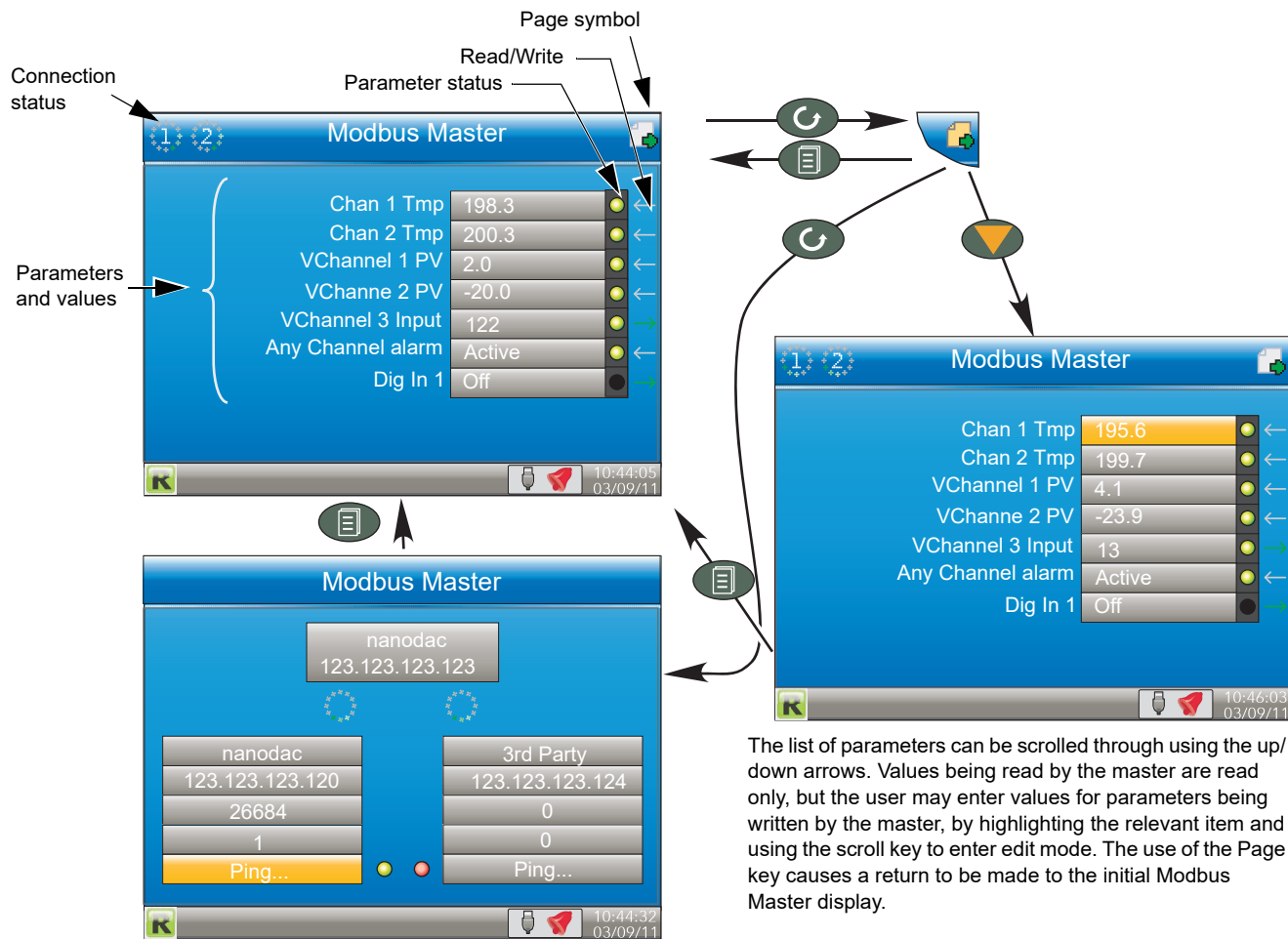

The list of parameters can be scrolled through using the up/down arrows. Values being read by the master are read only, but the user may enter values for parameters being written by the master, by highlighting the relevant item and using the scroll key to enter edit mode. The use of the Page key causes a return to be made to the initial Modbus Master display.

Figure 47 Modbus Master display pages

Ping Details

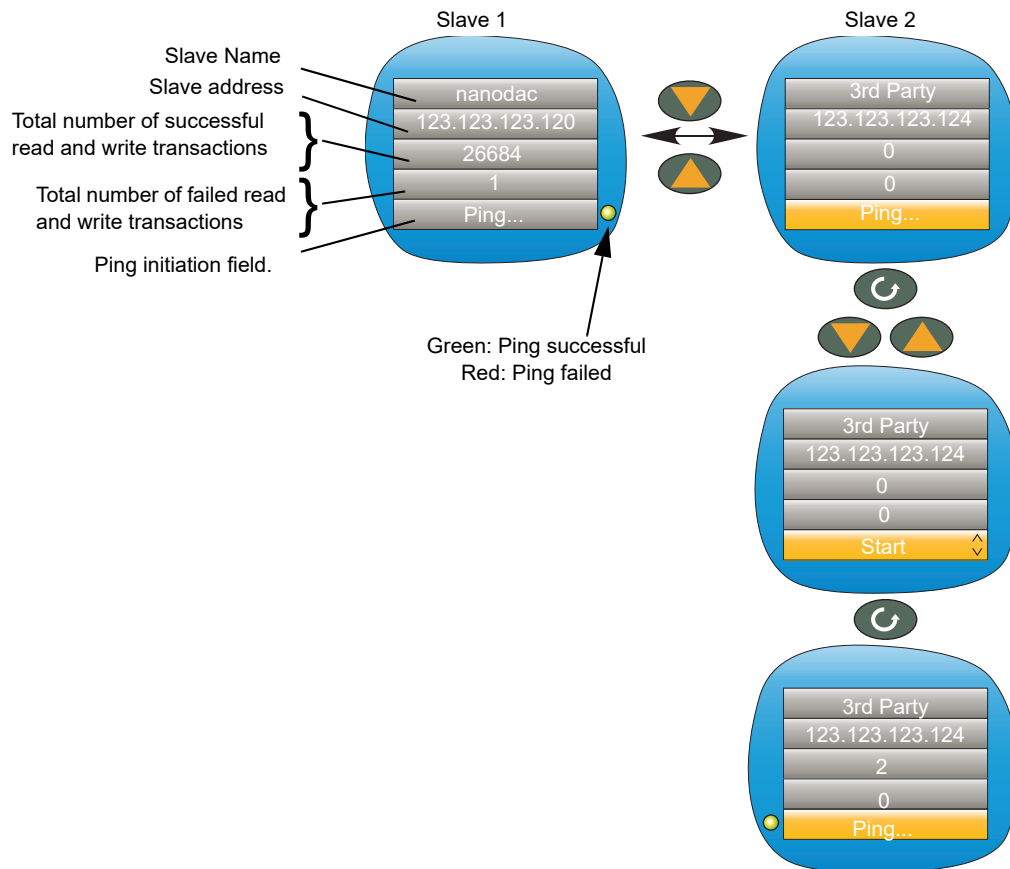

Figure 48 Slave 2 ping initiation (Slave 1 similar)

The 'Ping...' field of the first slave is highlighted by default. As shown above, the down (or up) arrow can be used to highlight the 'Ping...' field of the other slave instead.

Once the relevant 'Ping...' field is highlighted, the scroll key can be used to enter edit mode and the up/down arrow key used to select 'Start'. A further operation of the scroll key initiates the 'Ping' and if this is successful, a green indicator appears alongside the field (and the text returns to 'Ping...'). If the Ping is unsuccessful, then the indicator is coloured red.

The up or down arrow can now be used to return to slave 1, or the page key can be used to return to the previous parameter display page.

As shown in the figure above, some diagnostic information is given. This includes the total number of successful attempts that the master has made to communicate with the relevant slave, and the total number of failed attempts. Fuller diagnostic details are to be found in the Modbus Master Communications configuration description ("Modbus Master Configuration" on page 182).

EtherNet/IP display mode

This display mode appears only if enabled in Instrument.Display configuration ("Display configuration" on page 94) and is used to display the input and output parameters assigned to the Client and Server input and output tables. Parameters which have been configured with descriptors are identified by these descriptors

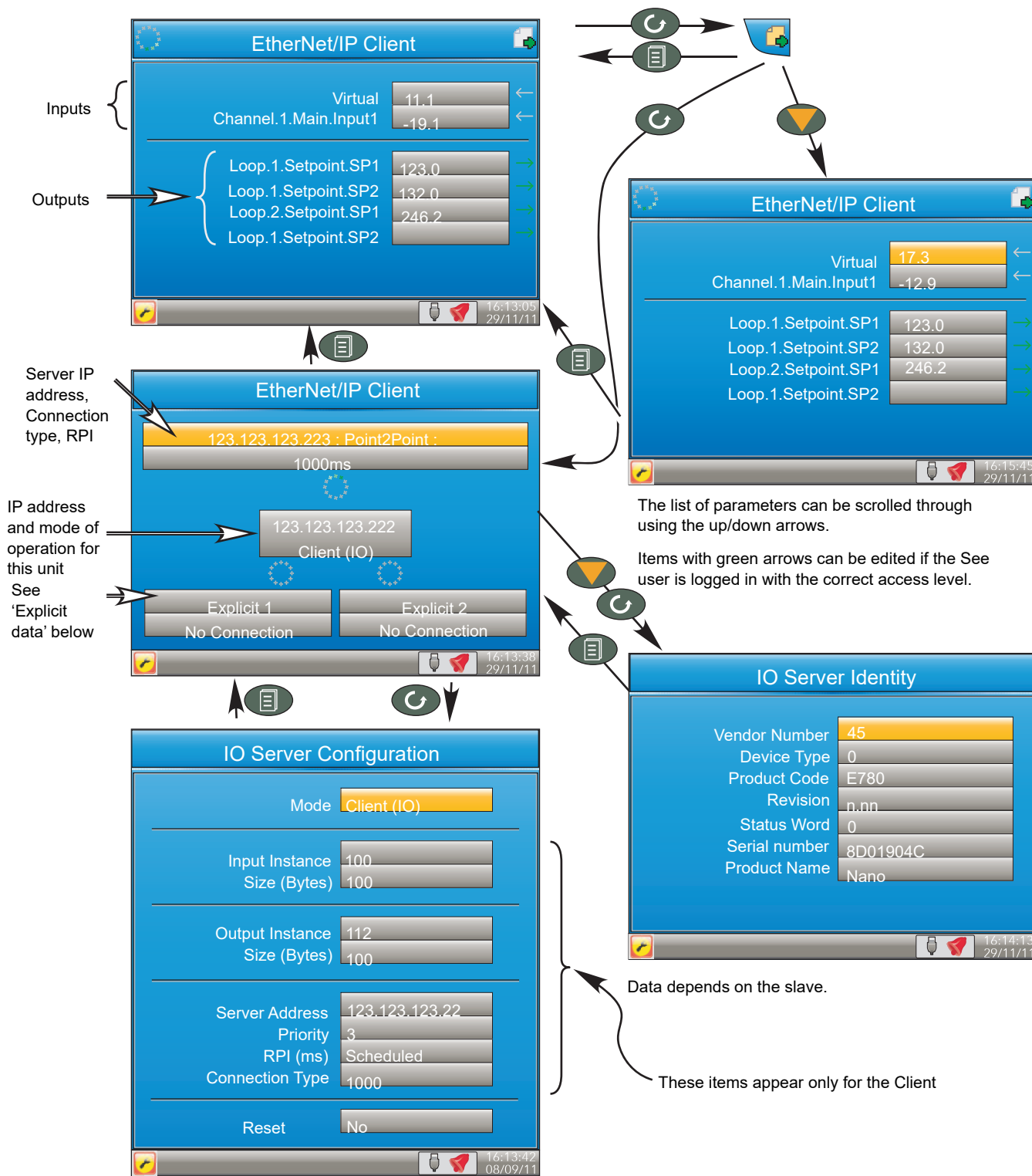

Figure 49 Typical EtherNet/IP display

If the EtherNet/IP option has been ordered and enabled, the nanodac can be configured as either a client (master) or a server (slave) (see "Ethernet/IP Configuration" on page 189). The client and server displays are identical except that the configuration area of the client display is more extensive than that of the server display.

Figure 49, above shows a typical set of display pages for an EtherNet/IP client.

Configuration of Implicit Input/Output Tables

Configuration of the input and output tables is carried out via iTools drag and drop only by:

- a. Entering the parameters to be read by the client into the server output table.
- b. Entering the destination parameter into the equivalent location in the client input table.
- c. Entering the parameters to be written by the client into the client output table.
- d. Entering the destination parameter into the equivalent location in the server input table.

The example in [Figure 50](#) shows this (using the nanodac as the client) in graphical form, using just a few parameters (there can be up to 50 in each table).

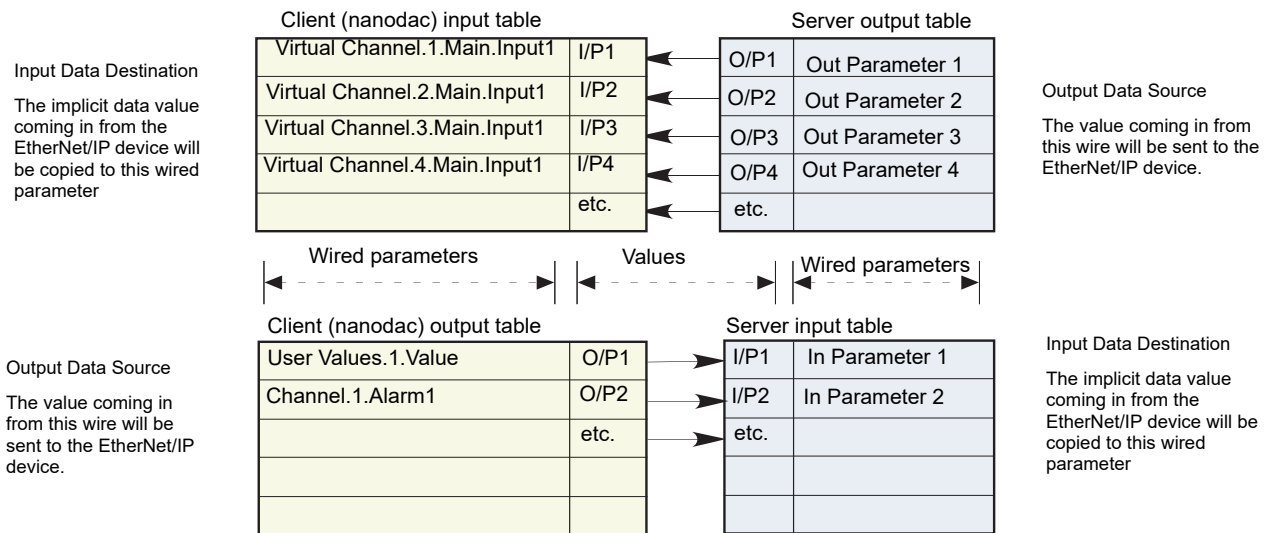

Figure 50 Input/Output table entries

NOTES:

1. Channel values from the Server can be 'wired' into nanodac Virtual channel inputs (as shown above) so that they can be traced and/or recorded. In such cases the virtual channel 'Operation' must be set to 'Copy' (see "Maths channel configuration" on page 133).
2. Inputs and outputs would normally be given suitable descriptors (e.g. 'Reset timer' instead of 'Channel.1.Alarm1').

Connection Status Indicator

A circular status indicator appears in a number of the EtherNet/IP display pages. This indicator can indicate the following states:

Green rotating 'flash': the instrument is on line and at least one CIP connection is established.

Green flashing circle: the instrument is on line but no CIP connections have been established.

Red flashing circle: there is a break in the physical connection between the client and the server, or the remote unit is switched off or is initialising.



Adding parameters to the input and output tables can be achieved only through the proprietary software package 'iTools', running on a PC. It cannot be configured through the user interface. The following description assumes that the user is familiar with 'iTools'. "iTOOLS" of this manual shows how to set up an iTools link to the unit and the iTools on-line help system and its PDF version (HA028838) should be referred-to as necessary.

Note: The client/server and the PC must all be on the same network.

Once iTools has started up and the 'Scan' process has 'found' the relevant instrument, the scan process should be stopped and the instrument (s) allowed to synchronise. (The scan may be left to run its course, but the speed at which iTools operates is reduced for the duration of the scan process.)

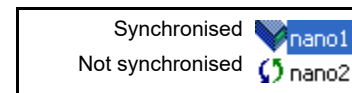

Example

To add Loop 2 Setpoint 2 to Output 4 of the Client Output table. In the example shown below, the instruments have both synchronised, and the 'Access' tool button clicked-on for both instruments to set them into configuration mode. With the client selected, expand the EtherNet/IP folder in the Browse list, then double-click on the 'ImplicitOutputs' folder. Locate and expand the Loop 2 SP folder in the Browse window, and click-drag SP2 to 'Output 4' and release.

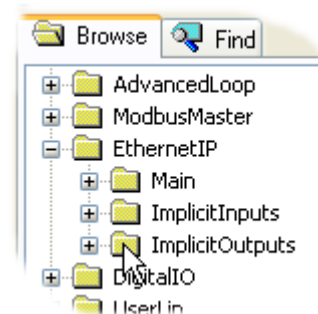

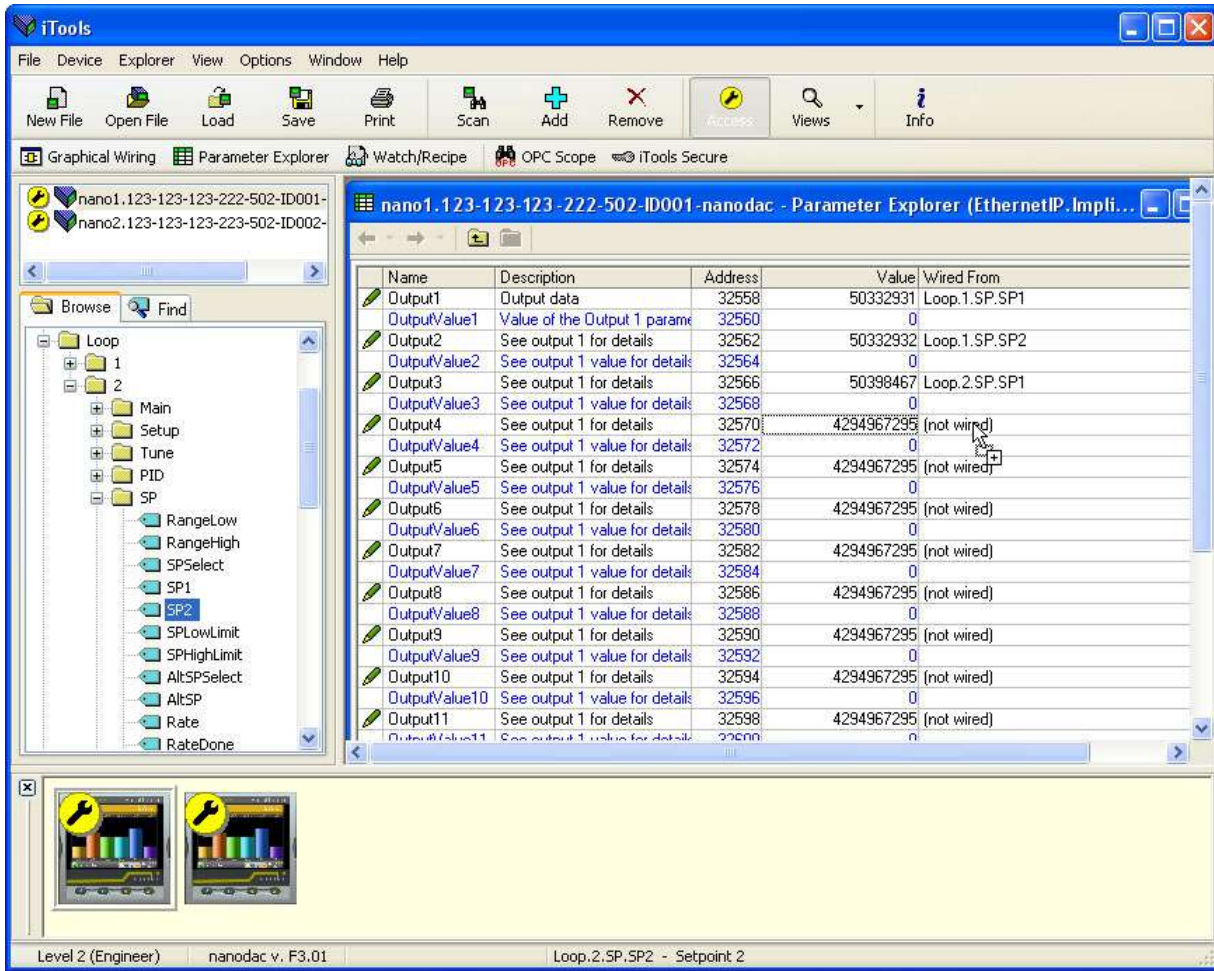
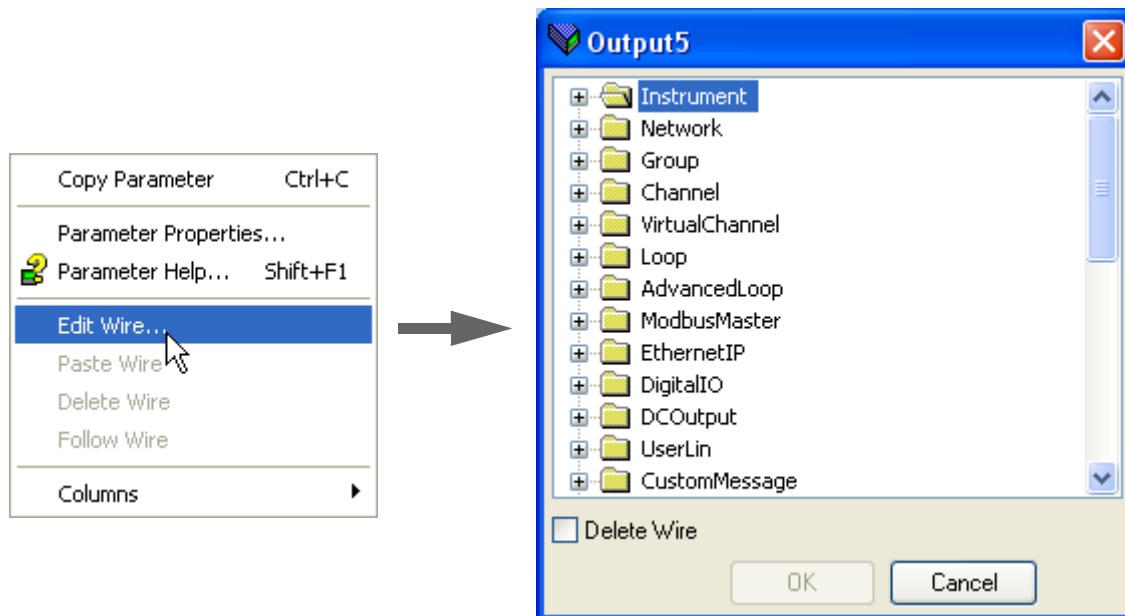

Figure 51 Dragging a parameter to the Output table

An alternative to the click-drag technique is to right click on the required output (five in the example below), and select 'Edit Wire...' from the context menu that appears. A browse window pops up, allowing the user to navigate to the required parameter. This technique can be used both on previously empty inputs or outputs and on those previously filled.



Explicit Data

As shown in [Figure 53](#), when configured as a server, there is only one explicit application object, and that has the class ID= A2 (162 decimal). The instance ID is the Modbus address of the parameter and the Attribute is always = 1. Explicit service codes hex10 (decimal 16) and 0E (14) are both supported, for writing and reading single attributes respectively.

Service code		Class ID		Instance ID	Attribute
Hex	Dec			Decimal	
0010	16	A2	162	1-65535	1
000E	14	A2	162	1-65535	1

Figure 53 Explicit data specification

When configured as a client, two separate connections are available allowing the user to produce two independent explicit read or write messages to different server devices.

[Figure 54](#), shows an example of how to configure an explicit message request. The instance ID and the data type are taken from the server manufacturer's data. In this example a read request is configured to determine the Group recording status of a nanodac server, and it can be seen from the table in "Parameter List" on page 232 that the decimal Modbus address for this parameter is 4150 and the data type is int16. It is this address which is used as the instance ID.

Once all the information has been entered, the read is requested by setting 'Send' to 'Yes'. The Data field changes to '3' for this example and from the table in "Parameter List" on page 232 it can be seen that the recording status is 'Recording enabled'.

Note: The nanodac supports only 16 bit data types for reading and writing of explicit messages.

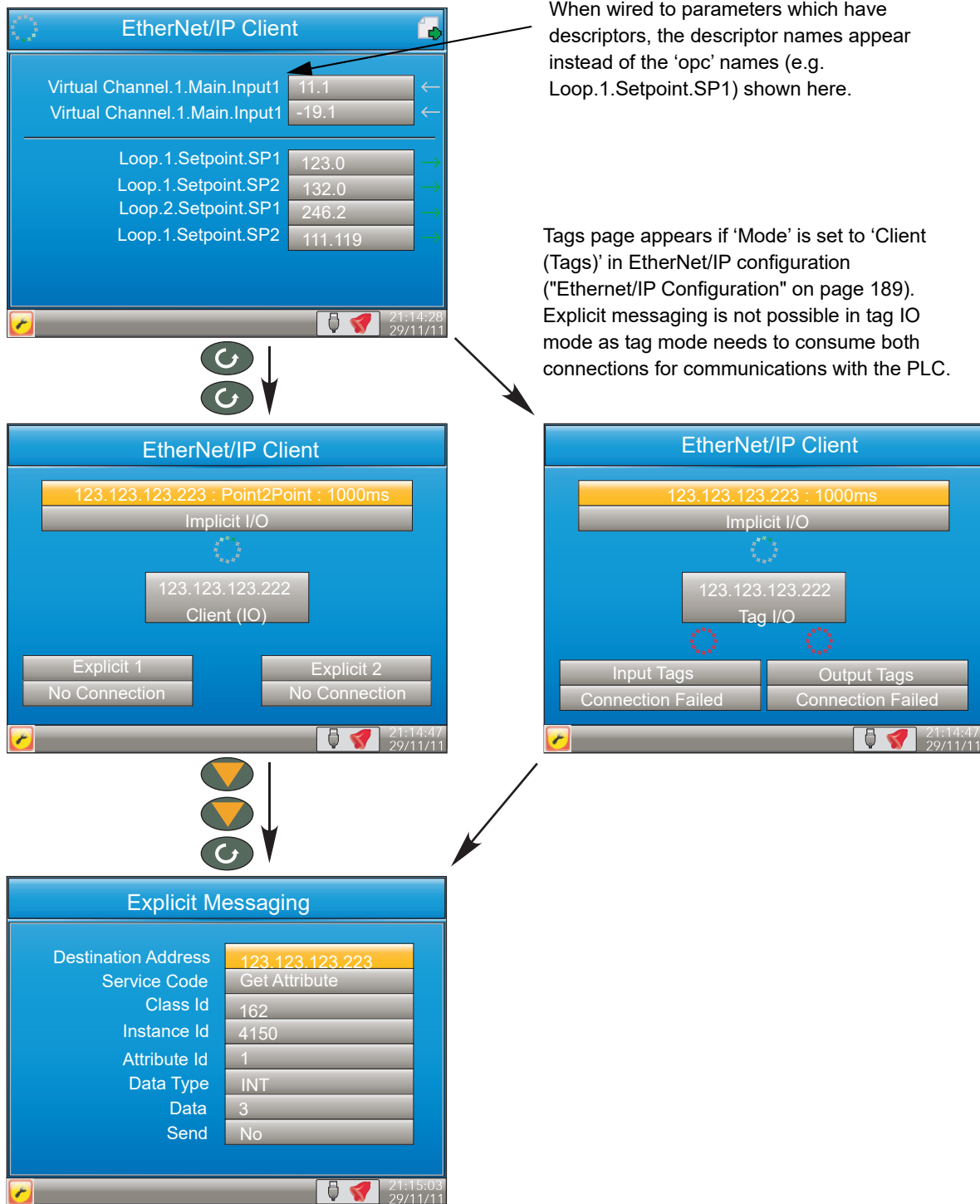

Figure 54 Explicit messaging example

Using Tags

When acting as servers, many PLCs present their data in a tag format instead of implicit data format. For this reason, when the client is configured as 'Client (Tags)', (see "Ethernet/IP Configuration" on page 189) 30 input and 30 output tags become available to the user via iTools (Figure 55).

This allows tag names to be typed in, input tags 1 to 30 being associated with implicit inputs 1 to 30 respectively and output tags 1 to 30 being associated with implicit outputs 1 to 30 respectively.

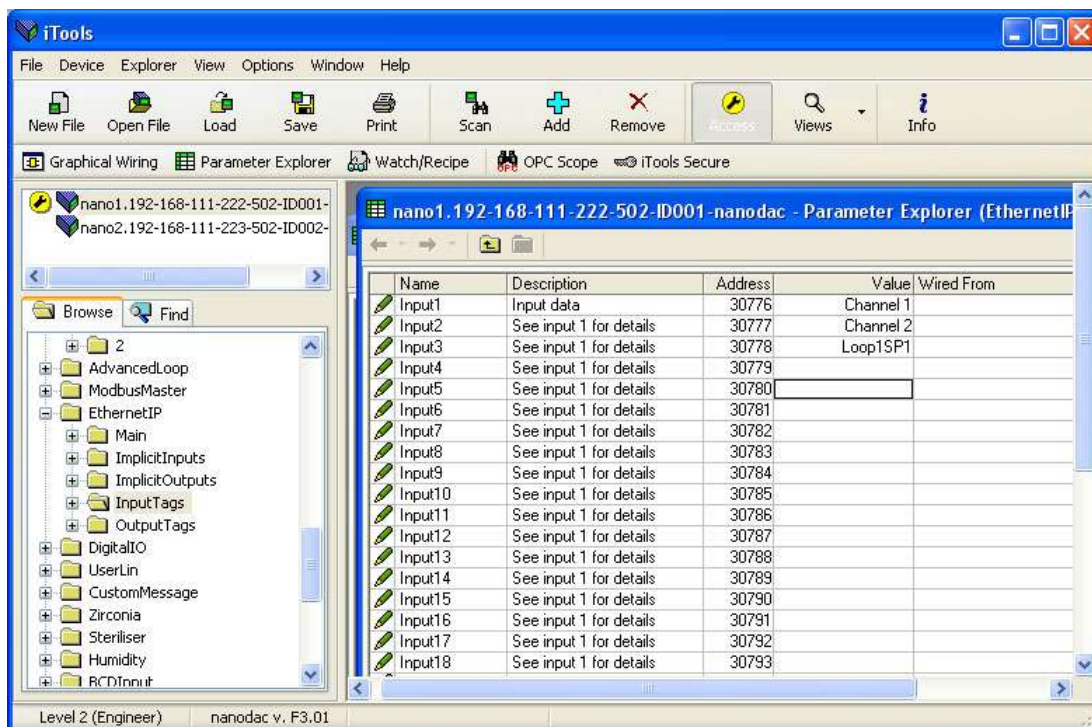

Figure 55 iTools display showing input tags.

In the example above, the value of the parameter with the tag 'Channel 1' will be written to implicit input 1.

NOTES:

1. Most PLCs have a data buffer limit of 500 Bytes. The total number of bytes being used is given by the equation: Total number of data bytes = (tag length + 10) × the number of requested tags.
2. Input data direction is always to the nanodac: in server mode input data is written to the nanodac from the client in client mode, input data is read by the nanodac from the server device.
3. Output data direction is always from the nanodac: in server mode output data is written to the client from the nanodac in client mode, output data is read by the server from the nanodac.

Trend History

Entered from the top level menu ("Introduction" on page 25), this allows vertical and horizontal traces to be reviewed for Trend group channels. The amount of data displayed in one screen depends on the 'Zoom In/Out' setting in the History menu ("History Options Menu" on page 89) and on the recording interval selected in Group Recording configuration ("Group Recording configuration" on page 117). It is also possible to enter a time and date to which the history then jumps.

The history display is identical in appearance with the trend display except:

1. History displays can include messages if so configured in the History menu.
2. For horizontal trends, the scale is displayed permanently at the left edge of the display.

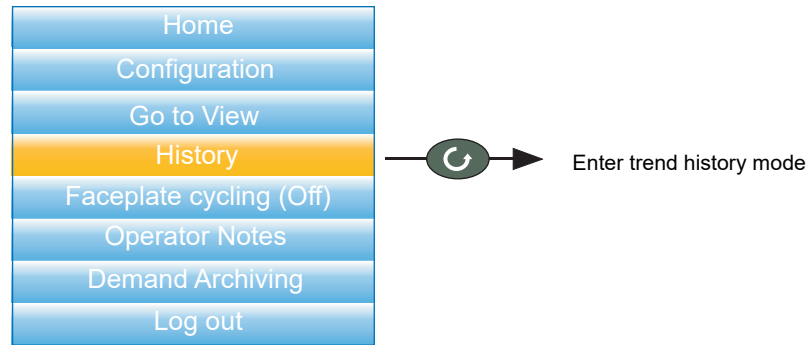





Figure 56 Top level menu

Navigation

-  The down arrow button moves the display backwards in time by 1/3 screen-full per operation (assuming that the current display is not the earliest). See also 'SEARCH FOR', below.
-  The up arrow button moves the display forwards in time by 1/3 screen-full per operation (assuming that the current display is not the latest). See also 'SEARCH FOR', below.
-  The scroll key scrolls through the trend group channels, emphasizing each channel (and displaying its faceplate) as it is selected.
-  The page key calls the History Menu, described in "History Options Menu" on page 89, below.

Search For

In the history display, holding the up or down arrow key operated for approximately two seconds produces a 'Search for' display which allows the user to enter a time and date. Once a time and date have been entered, 'Yes' then causes the history display to jump to that time and date (if such history exists).

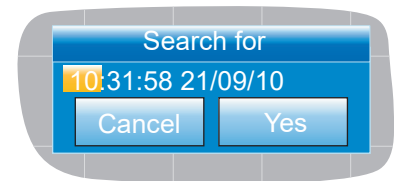

To enter a time and date:

1. Use the up/down arrows to highlight the item to be edited.
2. When highlighted (orange background), operate the scroll button. The highlighted text turns black.
3. Use the up and down arrow keys to scroll to the required value for the field, then operate the scroll button again. The text goes white.
4. Repeat the above editing process for all the remaining items which are to be edited.
5. Use the up/down keys to select 'Yes'. The 'Search for' window closes, and the history display jumps to the selected time and date.

NOTES:

1. N If no history exists for the selected time and/or date 'No History Available' is displayed.

- The time and date format and Daylight Savings Time (DST) effects are as set in the 'Locale' area of Instrument configuration. See "Locale" on page 93 for further details.

History Options Menu

Operating the page key from within a history display, causes the History Options menu to appear.

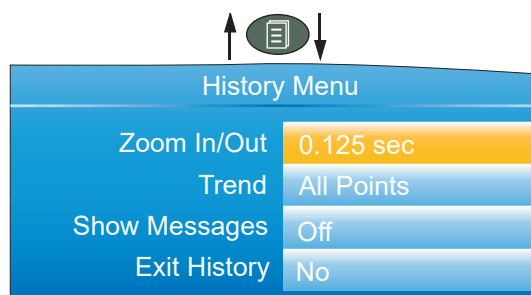

Figure 57 History Options menu

Parameters

Zoom In/out	Allows the user to select the amount of history displayed on the screen.
Trend	Select either 'All Points' or 'Each Point'. 'All points' displays all channels in the trend group, with the first channel emphasized on the screen and its faceplate displayed. The Scroll button is used to select the next channel in the group. 'Each Point' initially displays only the first point in the trace group. The scroll key is used to cycle through individual group channels in turn.
Show Messages	'Off' disable the inclusion of messages in history display. 'On' causes messages to appear, superimposed upon the point traces (vertical trend mode only).
Exit History	Selecting 'Yes' for this item causes a return to the top level menu or to the message summary page.

Note: Operating the page key from the History menu causes a return to the history display.

Text Entry

The user is often required to enter text characters or numbers (when editing operator notes, for example). This is done using the pop-up keyboards which are displayed when required. When only numerals are required a special keyboard is presented which contains only numerals.

Figure 58 shows the three standard keyboards, along with a 'scan' direction for operations of both up arrow and down arrow keys. To change keyboards, use the arrow push buttons to highlight the keyboard name ('Numeric', 'Symbols' or 'Alpha'), and then operate the scroll button.

Generally, to enter text, the required character is highlighted using the up and down arrows and the scroll button is used as an 'Enter' key. Once text entry is complete, the Page button is used to confirm the edit (use the down arrow to select 'Yes' then operate the scroll button).

Pressing and holding the scroll button and then immediately operating the up or down arrow, causes the character insertion point to move to the left (down arrow) or to the right (up arrow). The user can press and hold the scroll key to display variations on certain characters (the letter 'e' in the figure). Once displayed, the up and down arrows can again be used to scroll through auxiliary list, allowing capital letters, and characters with diacriticals (e.g. accents, umlauts, tildes, cedillas) to be selected and entered using the scroll button.

The backarrow key is used as a back space key - i.e. it deletes the character to the left of the cursor position. The 'Del' key deletes the character to the right of the cursor.

Note: Leading and trailing space characters are automatically removed from text strings.

Press and hold scroll button for alternative character set.

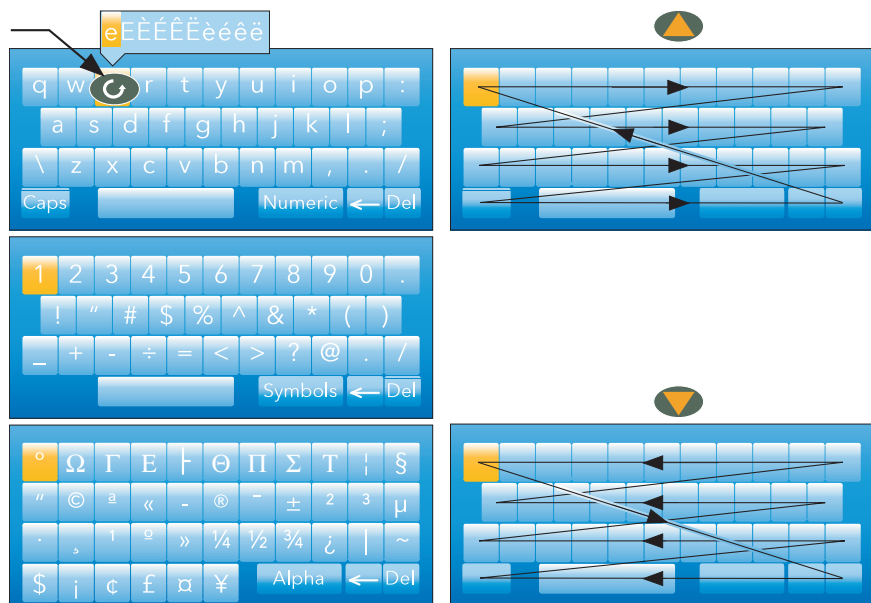

Figure 58 Standard Keyboards

Numeric keyboard

As mentioned previously, for functions which can take only numerals, a special numeric keyboard appears, as depicted in [Figure 59](#).



Figure 59 Numeric keyboard

USB keyboard

Text and numeric entry can also be carried out using a USB keyboard as described in "USB Keyboard" on page 388.

Configuration

Entered from the top level menu ("Top Level Menu" on page 41) this allows the instrument configuration to be accessed and edited ('Engineer' access level required for full editing).

⚠ CAUTION

EQUIPMENT OPERATION HAZARD

When logged in at Engineer access level, recording is stopped and the input/output circuits are switched off. Ensure the controlled process is in a suitable control and recording state before entering the Engineer access level.

Failure to follow these instructions can result in injury or equipment damage.

As shown in Figure 60, below, the instrument configuration is arranged in a number of 'areas', each of which is allocated its own sub-section within this Section.

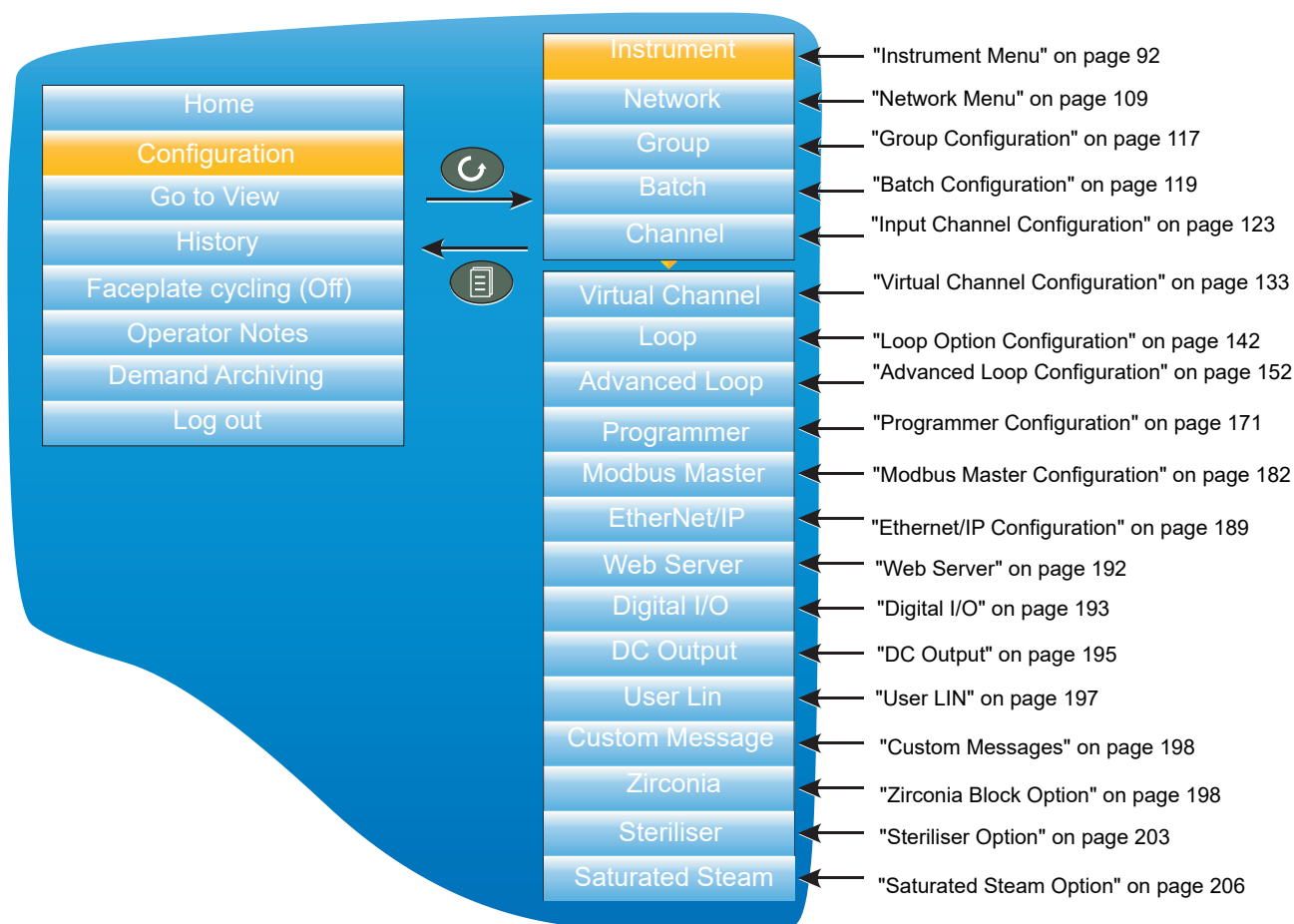
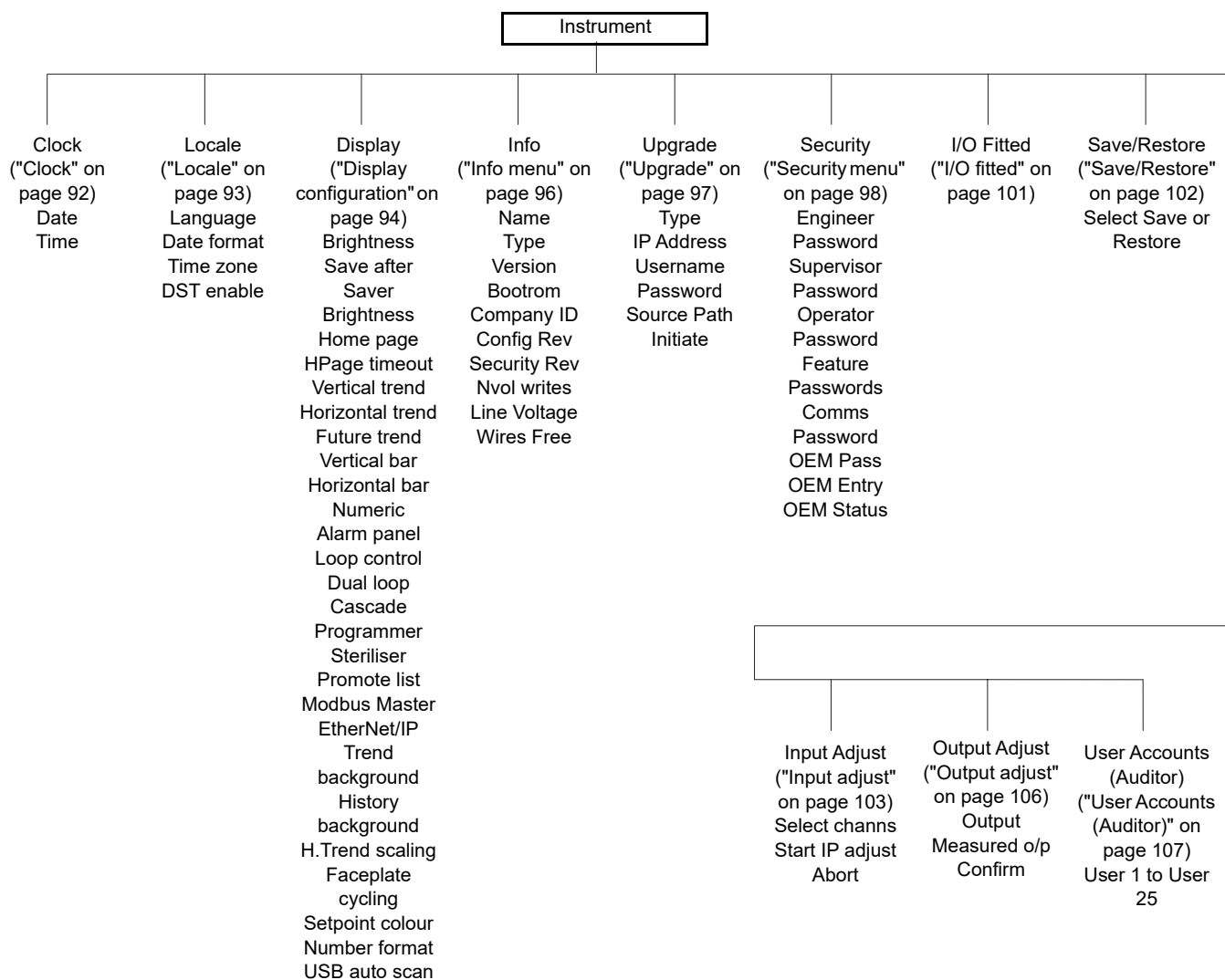

Figure 60 Top level configuration menu

The factory default configuration can be returned to, if required, by entering a special Engineer password, as described in "Security menu" on page 98.

Instrument Menu



Clock

The up and down arrows are used to highlight 'Date' (default) or 'Time'.

To set the date, the scroll button is used to display the numeric keyboard described in "Numeric keyboard" on page 90. The up and down arrows are used to highlight the relevant numeral or separator ('/' or ':') and the scroll key used to enter it into the display window.

To set the time, the scroll button is operated to enter edit mode, then the up and down buttons are used to scroll to display a time, say 15 seconds later than the current time. Once the current time matches the display, the scroll button is pressed to confirm the time and to start the clock.



Figure 61 Clock menu

The 'DST' field appears only if 'DST Enable' is selected 'Yes', in 'Locale' ("Locale" on page 93). If the 'box' contains a cross (as shown) then Daylight Saving Time (DST) is not currently active. A 'tick' means that the time shown has been advanced by an hour because DST is active.

Locale

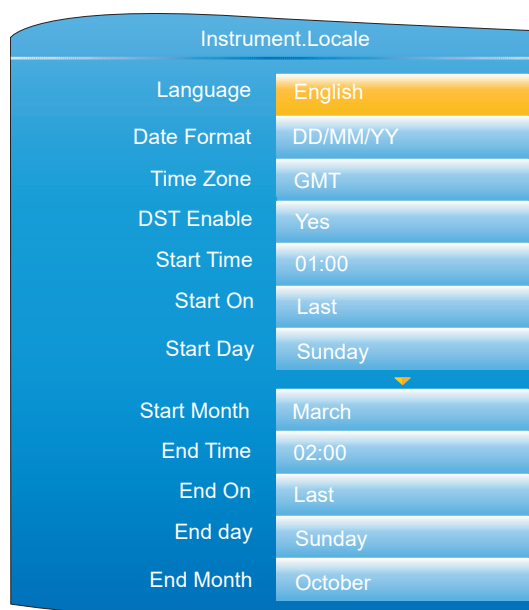

Figure 62 Typical Instrument configuration menu (expanded to show all fields)

Language	Select the language to be used for displays etc.
Date format	Select either DD/MM/YY, MM/DD/YY, or YY/MM/DD as the required format.
Time Zone	Select the required offset from GMT (UTC). This setting affects only the displayed time. Archiving, recording etc. times remain in GMT.
DST Enable	Daylight Saving Time enable. Once the selection is enabled, the following (previously hidden) fields appear, allowing the start and end dates for Daylight Saving Time (DST) to be configured. DST affects only the displayed time. Archiving, recording etc. times remain in GMT.
Start Time	Appears only when 'DST Enable' (above) is set to 'Yes'. Use the up/down keys to scroll to the required start time.
Start On	Select 'Last', 'First', 'Second', 'Third' or 'Fourth' as the required week. Used in conjunction with the 'Start Day' and 'Start Month' entries following.
Start Day	Select the day of the week on which DST is to commence.
Start Month	Select the month in which DST is to commence.
End Time, End On, End Day, End Month	As for 'Start Time' etc. above, but specifies the end time and date for daylight saving.

Display configuration

This allows the user to set display brightnesses and screen saver details, to select a display mode as the 'Home' page, and to enable/ disable the various display modes. The normal 'Select, Scroll, Enter' editing technique is used as has been previously described.

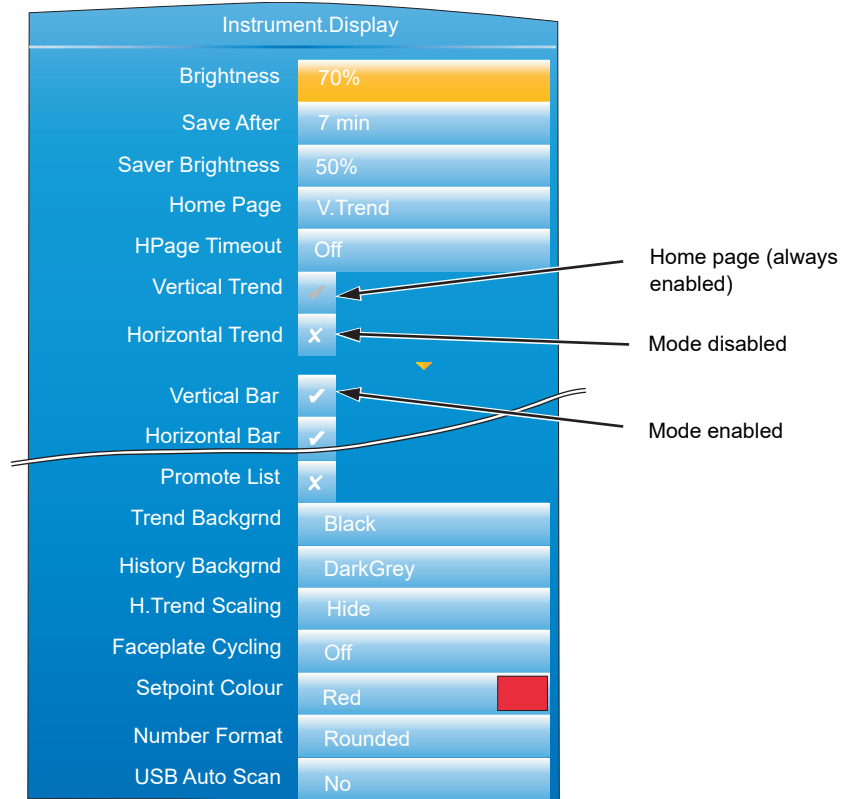

Figure 63 Display menu (expanded to show all fields)

- Brightness** Allows the user to select a normal operating brightness for the screen from 10% to 100%, in 10% steps.
- Save After** The elapsed time (since last button press) before the screen switches from 'Brightness' to 'Saver Brightness'. (Off = saver function disabled). Saver BrightnessThe screen saver brightness. Valid entries are 10% to 100% inclusive, in 10% steps. Using a lower power when not 'in use' not only saves power, but also increases display life. Typical screen power consumption is 0.5W at 100%, falling in a linear fashion to 0.05W at 10%.
- Home page** Allows any display mode to be chosen as the 'Home' page. This is the page that the instrument displays at power up, and also the page displayed when the 'Home' key is selected from the top level menu ("Top Level Menu" on page 41). The selected display mode (vertical trend in [Figure 63](#)) is always enabled in the following display mode enable fields (its 'tick' is greyed out and cannot be edited). See "Display Modes" on page 52 for a description of the available modes.
- HPage Timeout** The elapsed time (since last button press) before the display returns to the home screen. (Off = disabled).
- Vertical Trend** This is the default home page, and its tick is greyed. If this is not the home page, the tick can be changed to a cross, by highlighting it and operating the scroll button.

Horizontal Trend, Vertical Bar, Horizontal bar, Numeric, Alarm Panel, Loop control, Dual Loop, Cascade, Programmer, Steriliser, Promote List, Modbus Master, EtherNet/IP, Batch.

As for Vertical Trend, above. By default some display modes are disabled (grey cross). In order to enable such display modes the relevant cross is highlighted using the up/down arrow buttons, and the scroll button then used to change the grey cross to a white tick. The tick associated with the selected home page is always grey.

Note: Some display modes are available only if the relevant option is fitted.

Future Trend	This and the associated colour selections appear only if the Programmer option is fitted. See "Programmer Display Mode" on page 59 for more details.
Trend Background	Allows the user to select black (default), white dark grey or light grey as the 'chart' colour.
History Background	As above for 'Trend background', but for history displays.
H.Trend Scaling	As described in "Horizontal Trend Mode" on page 53, by default, the scale for horizontal trends appears at the left edge of the chart for a few seconds before the chart expands leftwards to occupy the scale area. Setting 'H.Trend Scaling' to 'Permanent', ensures that the scale remains permanently on display.
Faceplate cycling	Allows the default faceplate cycling state to be defined as 'On' or 'Off' ("Faceplate Cycling on/off" on page 46)
Setpoint colour	The colour for the setpoint in Control Loop display pages ("Control Loop1/Loop2" on page 57).
Number Format	Rounded Truncated
USB Auto Scan	If set to 'Yes', bar code data messages are automatically generated and appear on the display and in the Message list without operator intervention. If set to 'No', the Message appears on the screen for editing and/or confirmation, before being displayed etc. "Barcode Reader" on page 387 provides further details.

From firmware versions V3.01 and above there is an option to allow numbers to be rounded. The reason for this is driven primarily from a control point-of-view. With truncation, it is quite likely that the PV will look as though it never settles onto the setpoint. The rounding/truncation affects the UI display and MODBUS scaled integers, the underlying numbers are not affected, nor the values saved in the history files. Over MODBUS communications, all floating point parameters that are read via scaled integer communications will take note of the configured setting for rounding or truncating and reflect this. On the UI, ALL floating point values rendered will adhere to the configured setting of rounding or truncating.

Info menu

Gives information about the instrument hardware and software, and allows the user to enter a descriptor for the instrument. The normal 'Select, Scroll, Enter' editing technique, previously described) is used to edit those fields that are not read only.

Instrument Info	
Name	nanodac
Type	nanodac
Version	2.0
Bootrom	1.8
Company ID	1280
Config Rev	10
Security Rev	2
Nvol writes	339
Line Voltage	239.2 v
Wires Free	240

Figure 64 Info menu (expanded to show all fields)

Name	Allows the user to enter a descriptor of up to 20 characters, using the text entry techniques described in "Text Entry" on page 89. The number of characters visible in the display mode pages varies according to the number of alarm symbols on display.
Type	Nano. Read only display of the instrument model (used by 'iTools').
Version	Read only. The software version of the instrument.
Bootrom	Read only. Instrument software Boot ROM version
Company ID	Read only. For CNOMO ¹ purposes over Modbus (1280 decimal; 0500 hex).
Config Rev	Read only. This value is updated, and a message including this value generated, every time configuration is exited, if any one or more configuration parameter has been changed.
Security Rev	Read only. This number is incremented every time configuration is exited, if any one or more passwords has been changed, or if the FTP Server username has been changed, or if the Comms Enable field has been edited.
Nvol writes	Number of non volatile write operations for diagnostic purposes.
Line voltage	The instantaneous value of the supply voltage applied to the instrument. Used in some control loop operations.
Wires Free	This shows the number of wires free to be used. The value takes into account all user wiring whether carried out at the instrument or downloaded from the iTools graphical wiring editor.

Upgrade

This item allows the user to update the instrument firmware, either from a memory stick in the USB socket at the rear of the unit, or via FTP transfer from a host computer. Firmware upgrade files are downloaded from the instrument manufacturer and transferred to the instrument by memory stick or by FTP transfer. Splash screens are prepared by the user and transferred using a memory stick. The unit restarts automatically after an upgrade or splash screen replacement.

Note: After a firmware upgrade the Engineer password must be configured to allow any further operation, see [Engineer Password - Configuration \(page 33\)](#). All user accounts require an associated password.

⚠ CAUTION

INOPERABLE EQUIPMENT

Power must not be removed from the unit whilst upgrade is in progress.

The memory stick must not be removed whilst upgrade is in progress.

Removal of either of the above whilst an upgrade is in progress, will cause permanent damage to the unit.

Failure to follow these instructions can result in injury or equipment damage.

Instrument.Upgrade	
Upgrade	Firmware (FTP)
Server IP Address	123.123.123.123
Account Username	anonymous
Account Password	****
Source Path	release
Initiate	No

Instrument.Upgrade	
Upgrade	Firmware (USB)
Source Path	release
Initiate	No

Figure 65 Typical Upgrade menus

Upgrade	Select 'Firmware (USB)', 'Firmware (FTP)', 'Bootrom (USB)' or 'Splash (USB)' as the source of the upgrade.
Server IP Address	For 'Upgrade' = 'Firmware (FTP)' only, this field must contain the IP address of the PC which is to supply the upgrade file.
Account Username	For 'Type' = 'Firmware (FTP)' only, the username set up in the host FTP server
Account Password	For 'Type' = 'Firmware (FTP)' only, the password set up in the host FTP server
Source Path	The name of the directory from which the upgrade file is to be read. This is only the name of the directory without any path elements (e.g. '/') included unless the path is 'release/upgrade/files'.
Initiate	Select 'Yes' to initiate the upgrade.

Customising the Splash Screen

'Splash (USB)' allows the user to select a new image for the splash screen (i.e. the screen that appears at power up or restart). When 'Initiate' is set to 'Yes', the instrument searches the USB device for a file called 'splash.bmp' located in the 'release' folder. If such a file is found, it is loaded, and the instrument re-starts with the new image as the 'splash' screen. If no file is found, the request is ignored. If the image is not of the correct type or size, the instrument re-starts with the default splash screen.

The original splash screen is included on the 'tools' DVD, so that it can be restored if required. Rules:

1. This feature is available only with Bootrom versions 2.0 and above.
2. The file must be located in a folder called 'release' and the file name must be 'splash.bmp'.
3. The image must be 320 x 240; 24-bit resolution.
4. The image must be in bitmap (suffix.bmp) format.
5. The image may not exceed 256kB.

Security menu

This allows the user to enter passwords for all security levels (except logged out), and to enable/disable serial communications security.

Instrument.Security	
Engineer Pass	*****
Supervisor Pass	
Operator Pass	
Feature Pass	12345
Feature2 Pass	1232
Feature3 Pass	54321
Comms Pass	Enabled
OEM Pass	*****
OEM Entry	
OEM Status	Unlocked
Audit Trail	No
Signing	Yes
Authorisation	No
Login Timeout	Off
Pass Attempts	Unlimited
Min Password Len	3
Sup Log Disabled	No
Passwords Expire	Off
uuu Pass Expires	xx Days
Default Config.	No

Default Config. option appears only if Engineer Password = ResetConfig

Figure 66 Security menu

Engineer Pass

Gives access to configuration menus. The Engineer password must be configured to allow any access.

can be edited here, if required, by entering an alternative of up to 20 characters (Notes no.1).

If 'ResetConfig' (case sensitive) is entered as the Engineer Password, the 'Default Config.' field appears allowing the instrument default configuration to be restored (Notes no. 2).

Supervisor Pass A password of up to 20 characters must be entered here to protect Supervisor level access.

Operator Pass A password of up to 20 characters must be entered here to protect Operator level access.

If the Auditor (auditor) feature is enabled, this option is not available as Operator level access is replaced by Users 1 to 25 - all configured user accounts must have an associated password, making them available for selection.

Note: User accounts, of any access level require a password, otherwise they will not be available for selection.

Feature Pass This is a password supplied by the manufacturer to enable the software options (e.g. Loop, Zirconia block, Toolkit blocks, Batch, 21CF11, etc.). When applying for this password, the manufacturer will require the instrument's MAC address (Network.Interface menu "Interface" on page 110) and the instrument's firmware Version (Instrument.info menu "Info menu" on page 96). The password is MAC address dependent so that it cannot be used on any other instrument.

Note: When the Auditor feature is enabled, entry of an invalid feature password will result in the feature codes becoming read-only for a period of 30 minutes. This is to discourage multiple attempts to guess a feature password. This period cannot be shortened.

Feature2/3 Pass Similar to 'Feature Pass' above, but for additional features.

Comms Pass Enables/disables password security for external communications (including via iTools). If set to 'Enabled', the Engineer level password will be required if an attempt is made to enter the configuration menus from a remote PC. If set to 'Disabled', then access to configuration can be gained over a communications link, without a password. If enabled, then entry to configuration mode via the Instrument Mode (IM) parameter must be completed within 5 seconds of entering the password, or the attempt will fail.

NOTES:

1. It is recommended that only characters that appear on the user's PC keyboard be used in the Engineer password. The use of other characters makes it necessary to use 'Escape' codes (e.g. Alt 0247 for the '+' sign) when trying to enter configuration mode from iTools, for example.
2. Restoring factory default configuration can also be carried out in iTools, using the Engineer password 'ResetConfig' and selecting Default Config to 'Yes'.

OEM Pass The configured pass phrase used to enable / disable the OEM security option. This field is editable whilst the OEM Status is 'Unlocked' and the user has 'Engineer' access.

OEM Entry To lock or unlock the OEM security feature, the user must enter the pass phrase entered in 'OEM Pass' above. The default passcode is 'OEM' (in capitals).

OEM Status Read only 'Locked' or 'Unlocked' status display.

Audit Trail Determines whether an audit trail is written to the history file (when set to 'Yes'). When enabled, all configuration parameter changes, operator alarm acknowledgements, and

that during iTunes and USB cloning, the audit trail is temporarily disabled since, potentially, every parameter could change. However, the fact that a clone has been loaded will be written to the history by the audit trail. This field appears only if the Auditor feature is enabled.

Signing

When enabled (set to 'Yes'), if a user tries to enter a signable menu or edit a signable parameter, the signing dialog will appear (see below). For the required action to proceed, the selected signing user must enter their password and a note (which cannot be blank), and then set Accept to 'Yes'. If signing is accepted, messages are added to the history along with the entered note. This field appears only if the Auditor feature is enabled.

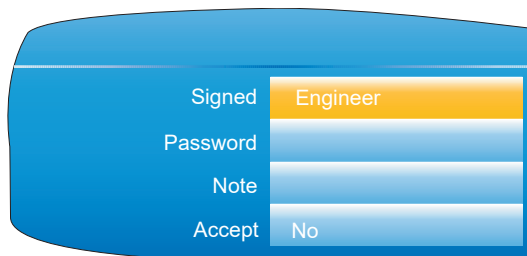

Figure 67 Signing dialog

Authorisation

When enabled (set to 'Yes'), similar to the Signing parameter above, an additional user (the authoriser) will need to enter their password to approve the operation. Other than the built-in Engineer or Supervisor accounts, an authoriser will need to have Authorising permissions assigned to him or her. Refer to section User Accounts (Auditor) to assign this permission to a user. This field appears only if the Auditor feature is enabled.

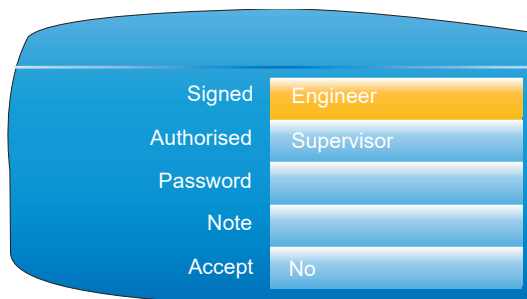

Figure 68 Authorising dialog

Login Timeout

Provides the option to log out an inactive (no key-presses detected) user when a preset number of minutes have elapsed. This can be set to 'Off' for no automatic timeout, or between 1 and 99 minutes. This field appears only if the Auditor feature is enabled.

Pass Attempts

Specifies whether a user has unlimited attempts of logging in ('Unlimited') or only three attempts before their account is disabled from logging in ('3'). This field only appears if the Auditor feature is enabled.

Min Password Len

Specifies the minimum number of characters allowed for a password, between 3 and 9 characters. This field appears only if the Auditor feature is enabled.

Sup Log Disabled

Determines whether the Supervisor level login is permitted ('No') or disabled ('Yes'). It is recommended that this be set to 'Yes' if the Auditor feature is used. This field only an-

Passwords Expire	Provides the option to specify the number of days before a password will expire. This can be set to 'Off' for no expiring passwords, or between 1 and 999 days. The expiry counter is reset when the password is changed. When the password expires, it will not work any more. The engineer's password never expires so as not to block all access. This field appears only if the Auditor feature is enabled.
{uuu} Pass Expires	If the Passwords Expire parameter is set to any number (other than 'Off'), indicating that passwords will expire after a set number of days, a list of all configured (and enabled) users is displayed next to the Pass Expires parameter, showing the number of days remaining before each account's password will expire. These are read-only and cannot be altered here. This field appears only if the Auditor feature is enabled, and the Passwords Expire parameter is set to anything other than 'Off'.
Default Config	This field appears only if 'ResetConfig' has been entered as the Engineer Password. Selecting 'Yes' Causes the instrument to restart with default configuration (i.e. the instrument 'cold starts'). See Note 2 above.

Note: After a cold start (returned to default configuration) the Engineer password must be configured to allow any further operation, see [Engineer Password - Configuration \(page 33\)](#). (All user accounts require an associated password).

OEM Security

In products that incorporate user wiring, the value of an application may lie more in the user wiring (connecting the function blocks together) than in the configuration of the instrument's parameters. OEM Security allows the user to prevent the application from being copied either via comms (by iTools or a third party comms package) or via the instrument's user interface.

When OEM security is enabled, users are prevented from accessing wiring (for reading or writing) from any source (comms or user interface), and it is not possible to Load or Save the configuration of the instrument via iTools or by using the Save/Restore facility ("Save/Restore" on page 102).

From firmware version V5.00 onwards OEM Security is enhanced by providing an option, enabled by a new parameter 'Instrument.Security.OEMParamLists. This parameter is available only through iTools and allows the OEM to:

1. Make all parameters that are read/write in Engineer access level only, read only when the instrument is OEM locked AND it is in Engineer access level. It is possible for the OEM to select up to 100 parameters which are to remain read/write in Engineer access level.
2. Make up to 100 parameters that are read/write in Supervisor access level, read only when the instrument is OEM locked.

Examples of how to set up OEM security are given in the iTools ("To Set Up OEM Security" on page 376).

I/O fitted

This provides a read only display showing what type of input or output circuit is associated with each set of rear terminals.

Instrument I/O Fitted	
1A1B	(Dig.IO)
2A2B	(Relay)
LALC	(Dig.In)
3A3B	(Relay)
LBLC	(Dig.In)
4AC	(Relay)
5AC	(Relay)

Figure 69 I/O fitted display

I/O Types

Dig.IO	Digital input/output
Relay	Relay output
Dig.In	Digital input
Dig.Out	Digital output
DC.Op	DC output

Note: The I/O types fitted in locations LALC, LBLC, 4AC and 5AC are always as shown above. The types of I/O fitted in locations 1A1B, 2A2B and 3A3B depends on the options specified at time of order.

Save/Restore

This allows the user to save and/or restore instrument clone configurations to a memory stick inserted into the USB connector at the rear of the unit. The format of the saved/restored files is iTools clone files (*.uic).

Selecting 'Restore' presents a list of clone files in the configured directory on the USB device. (In the example below, the file is located in the basic usb0 directory - it has not been saved to a particular configuration directory.)

When 'Save' is selected, the virtual keyboard must be used to enter the filename. If the file already exists on the USB device, a warning appears offering 'Cancel' or 'Overwrite' alternatives.

Notes:

1. The ability to save and restore is disabled if OEM security is enabled.
2. Configuration save/restore is available only when the unit is logged into at 'Engineer' access level.
3. During USB cloning (USB save/restore), the priority of modbus slave comms is lowered. This allows the save/restore process to complete in a minimal time (around 60 seconds). During this period, modbus slave comms response times will be extended and may result in the master device timing-out.

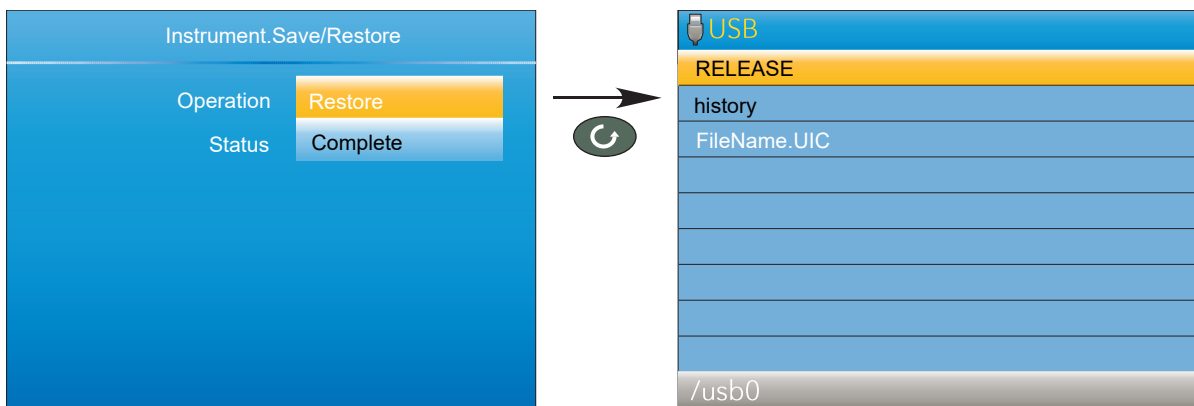



Figure 70 Save/Restore display

Operation	Select 'Save' or 'Restore'. Use the up/down arrow keys to highlight the required UIC file, then use the scroll key to initiate the operation.
Status	Shows the status of the operation, as follows: Inactive: Neither saving or restoring a clone file has occurred since the last time the instrument was power cycled. Complete: Indicates that the cloning process has completed. Restoring: Restore operation is currently in progress. Saving: A clone file is currently being saved. Cold started: A power-cycle of the product occurred whilst a Restore operation was in progress. The product configuration is unreliable and has been re-set to factory default. 

The 'Restoring' and 'Saving' status text is accompanied by an animated display (circling green 'flash') to indicate that the operation is in progress.

Note: After a cold start (returned to default configuration) the Engineer password must be configured to allow any further operation, see [Engineer Password - Configuration \(page 33\)](#). (All user accounts require an associated password).

Input adjust

Notes:

- Input adjust cannot be applied to input channels with input type of 'Digital', 'Test' or 'Off'.
- Input adjustments can be carried out only by users logged in as 'Engineer' (see "Login" on page 49).
- The instrument must be powered for a sufficient time (e.g. 30 minutes) for it to reach thermal equilibrium before an input adjust is performed.

This facility allows the user to compensate for tolerance errors etc. The technique used is to select those channels to which adjust is to be applied, then for each channel to:

- apply a known low level signal (at or close to the low input range value) to the relevant input. When the instrument reading is steady, press 'Apply'.
- apply a known high level signal (at, or close to, the high input range value) to the relevant input. When the instrument reading is steady, press 'Apply'.

Figure 71 shows a typical display when 'Input adjust' is selected from the Instrument menu, and Apply Adjust has been selected. As can be seen, Channel 3 has previously been adjusted.

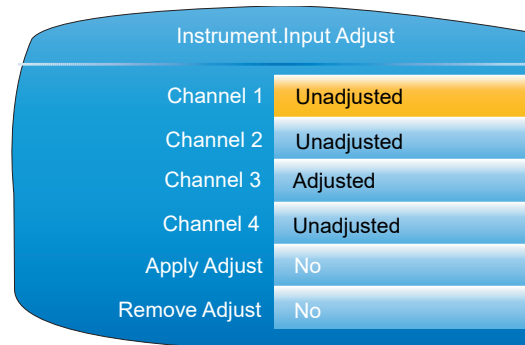

Figure 71 Input adjust top level display

Channel 1 to 4	Shows the adjust status of each channel.
Apply Adjust	Selecting 'Yes' initiates the adjustment procedure described below.
Remove Adjust	Selecting 'Yes' initiates the adjustment removal procedure described below.
Abort	Allows the user to abandon input adjustment at any point in the procedure.

Adjustment Procedure

- As shown in Figure 72, highlight the 'Apply Adjust' field, and operate the scroll key to enter edit mode. Use the up or down arrow key to select 'Yes'. Use the scroll button to change Channel 1 'cross' to a 'tick' (check mark). Similarly select any other channels which require adjustment.

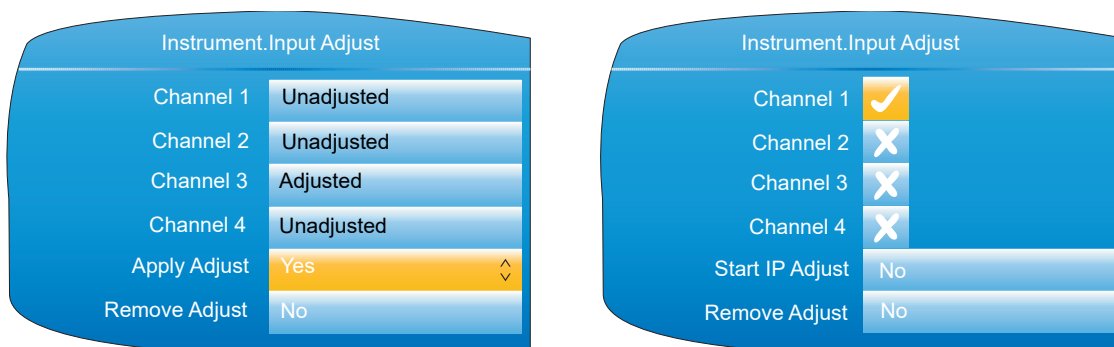

Figure 72 Channel adjustment procedure (1)

- Highlight the 'Start IP Adjust' field and use the scroll and up/down arrow to select 'Yes'. Use the scroll key again to enter the low value adjust page.
- Apply the known low value and wait for the value to stabilise. Enter the 'Low Target Value' (the value that the instrument is to read for the applied input). When all is steady, use the scroll and up/down arrow to set the 'Confirm Low' field to 'Yes', then operate the scroll button again.

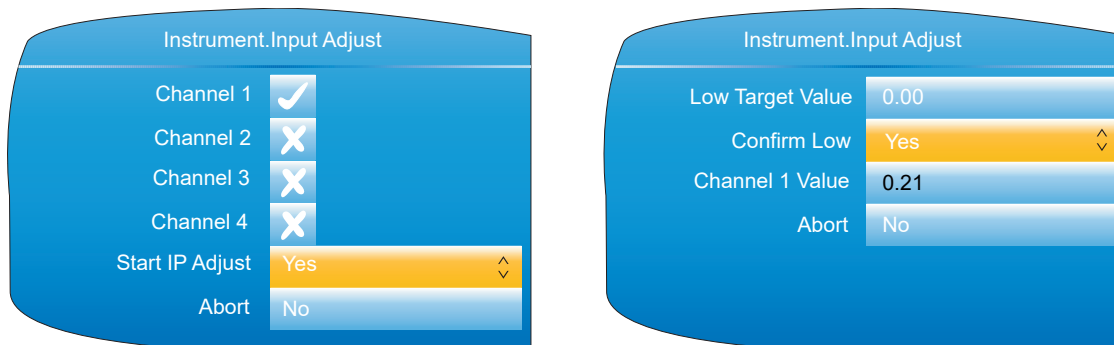

Figure 73 Channel adjustment procedure (2)

4. The display changes to the high value adjust page.
5. Apply the known high value and wait for the value to stabilise. Enter the High Target Value (the value that the instrument is to read for the applied input). When all is steady, set 'Confirm High' to 'Yes'.

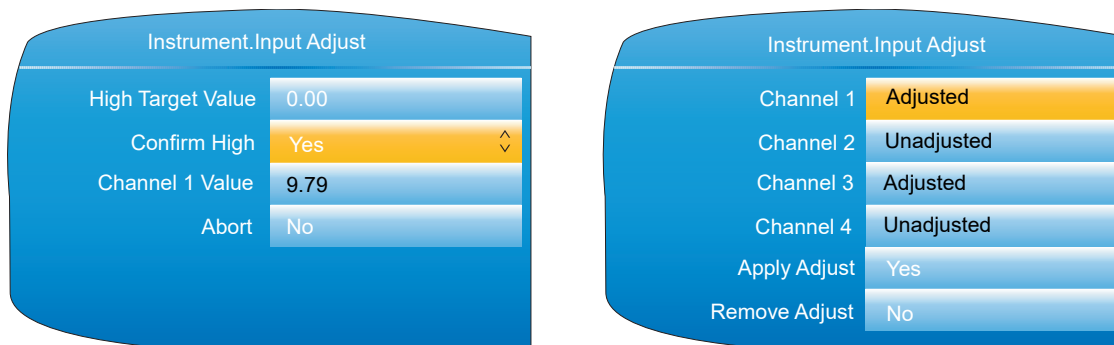

Figure 74 Channel adjustment procedure (3)

Removal Procedure

1. Set 'Remove Adjust' to 'Yes' and operate the scroll button.
2. Use the scroll and up/down arrow buttons to change the required channel icons from crosses to ticks.
3. Select Remove IP Adjust to 'Yes' and operate the scroll key. The adjustment is removed from all selected channels without further confirmation.

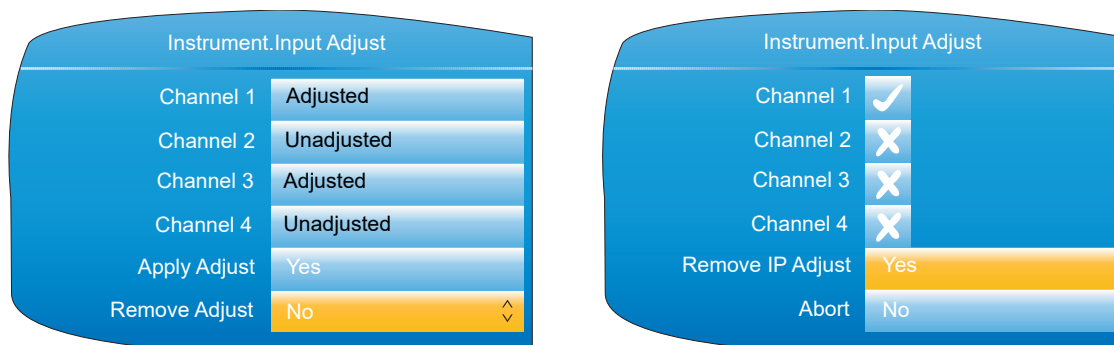
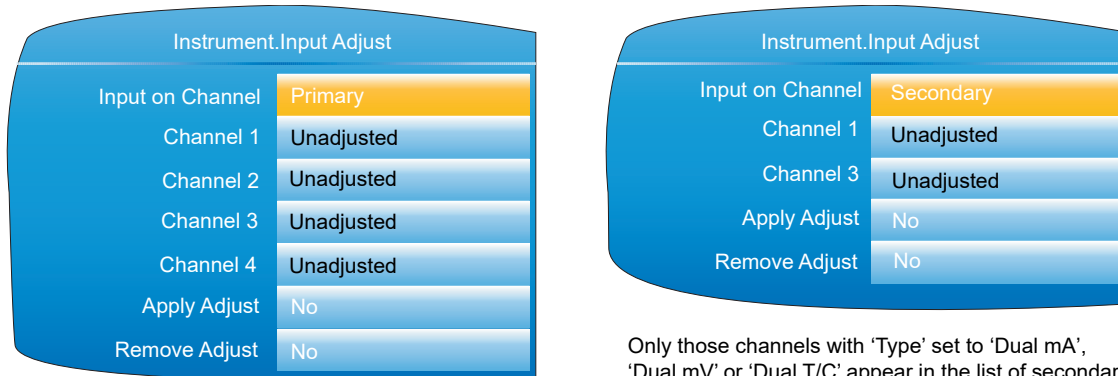

Figure 75 Channel adjustment removal

Dual Input Channels

For the dual input channel option, input adjust is carried out as described above, except that for any channel where dual inputs are configured, the user must initiate adjustment to primary and secondary inputs separately. As shown in **Figure 76**, a new field 'Input on Channel' is introduced for this purpose.



Only those channels with 'Type' set to 'Dual mA', 'Dual mV' or 'Dual T/C' appear in the list of secondary channels. In this example, only channels 1 and 3 are configured as dual input. (See "Channel Main" on page 123 for channel Type configuration.)

Figure 76 Input adjust top level display (dual input channels)

For primary inputs, all four channels are included in the list and can therefore be selected for adjustment. For secondary inputs, only those channels which have been configured as dual input are included.

Output adjust

This item appears only if one or more of I/O type DC Output is fitted and allows the user to compensate for tolerance errors etc. in connected equipment.

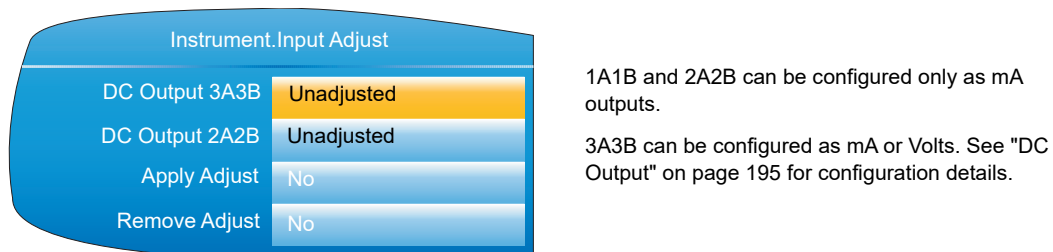

1A1B and 2A2B can be configured only as mA outputs.
3A3B can be configured as mA or Volts. See "DC Output" on page 195 for configuration details.

Figure 77 Output adjust initial display

Adjust Procedure

1. Highlight the 'Apply Adjust' field, and operate the scroll key to enter edit mode. Use the up or down arrow key to select the required output and confirm with the scroll key. The output adjust page appears for the low point.
2. Measure the output at the required point, and enter this value in the 'Measured Output' field using the text entry techniques described in "Text Entry" on page 89. To skip this stage go to step 3.
3. Set 'Confirm Low' to 'Yes'. The output adjust page appears for the high point.
4. Measure the output at the required point, and enter this value in the 'Measured Output' field as described for the low point. To skip this stage go to step 5.

- Set 'Confirm High' to 'Yes'. The output adjust initial display reappears, with the word 'Adjusted' in the relevant DC Output field.

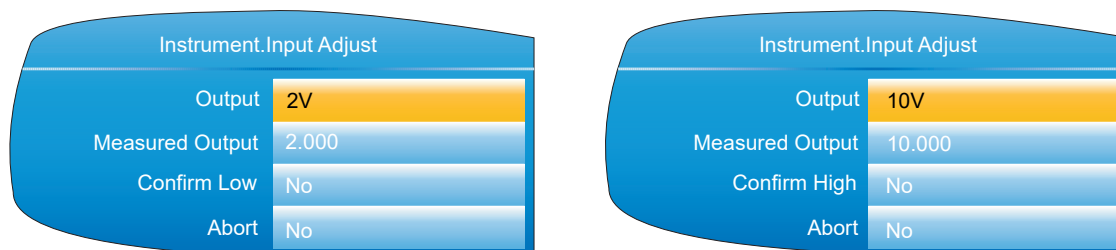

Figure 78 Low and High adjust point displays

Notes:

- The figures above show the displays when the DC output is set to 'Volts' ("DC Output" on page 195) (3A3B only). The mA displays are similar, but the fixed low and high values are 4mA and 20mA respectively
- 'Abort' cancels operations so far and returns to the output adjust initial display (Figure 77).

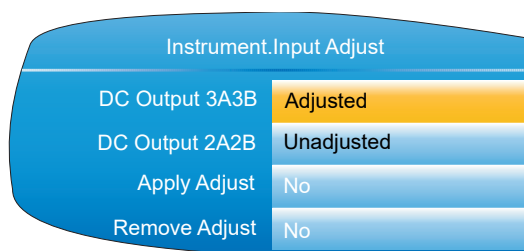

Figure 79 Adjusted display

Adjust Removal

In the output adjust initial display (Figure 79) highlight the 'Remove Adjust' field, and operate the scroll key to enter edit mode. Use the up or down arrow key to select the required output and confirm with the scroll key. The output adjustment is removed, without confirmation. The initial display returns to 'Unadjusted' as in Figure 77.

User Accounts (Auditor)

The User 1 to User 25 options only appear if the Auditor feature is enabled. These parameters provide up to twenty five additional user accounts, each of which can be configured with customisable levels of permission. The built-in Operator account is disabled when this feature is enabled, but the default username for User 1 is set as 'Operator'. Note that when the Auditor feature is enabled, the Logged Out user has no permissions. Select the user account you wish to configure and press the scroll key. The user configuration page appears.

Instrument User 1	
Username	User 1
Password	*****
Batch Control	No
Ack Alarms	No
Demand Archiving	No
Login Disabled	Yes
Authorising	No
Archive Interval	No

Figure 80 User account configuration

- Username** The username for the user (up to 20 characters). Typically only the first 12 characters are displayed in scroll lists (such as when logging on) due to space. User 1 defaults to the user called "Operator", which replaces the standard Operator account when the Auditor feature is enabled. This standard account has no additional permissions applied to it, however, and can be modified, disabled, or overwritten. When logging in, the user account number (1 to 25) is prefixed to the username so that each name is unique.
- Password** The password for the user being edited (up to 20 characters).
- Batch Control** When enabled (set to 'Yes'), the user can control batches via the batch control page (see "Batch Control" on page 76) from the batch summary page.
- Ack Alarms** When enabled (set to 'Yes'), the user can acknowledge alarms in the alarm summary page (refer to Alarm Summary -"Go to View" on page 43).
- Demand Archiving** When enabled (set to 'Yes'), the user can access the Demand Archiving page (see "Demand Archiving" on page 46 for further details).
- Login Disabled** When enabled (set to 'Yes'), the user is disabled and cannot login, sign or authorise. Set to 'No' to enable the user. If the maximum number of login attempts has been exceeded for an account, this parameter is automatically set to 'Yes' to prevent further login attempts. The number of login attempts permitted is set using the 'Pass Attempts' parameter in the Security menu (refer to "Security menu" on page 98). Each failed login attempt is recorded in the history, as is the user's login being disabled after the specified number of failed login attempts.
- Signing** When enabled (set to 'Yes'), the user will appear in the user scroll list of the signing dialogue (refer to the Signing parameter in "Security menu" on page 98).
- Authorising** When enabled (set to 'Yes'), the user will appear in the user scroll list of the authorising dialogue (refer to the Authorisation parameter in "Security menu" on page 98).
- Archive Interval** When enabled (set to 'Yes'), the archive interval will be writeable in the user page; otherwise it will be read-only (refer to "User menu" on page 42 for details).
- Loop Control** When enabled (set to 'Yes'), the user can change the set-point, Mode and Manual output fields in the loop control screens (refer to "Control Loop1/Loop2" on page 57 for de-

Program Mode	When enabled (set to 'Yes'), the user can change the mode of programs (see "Programmer Display Mode" on page 59).
Program Edit	When enabled (set to 'Yes'), the user can edit programs (see "Program Editing" on page 40 within "Programmer Display Mode" on page 59).
Program Store	When enabled (set to 'Yes'), then user can store programs (see "Program Details" on page 41 within "Programmer Display Mode" on page 59).

Network Menu

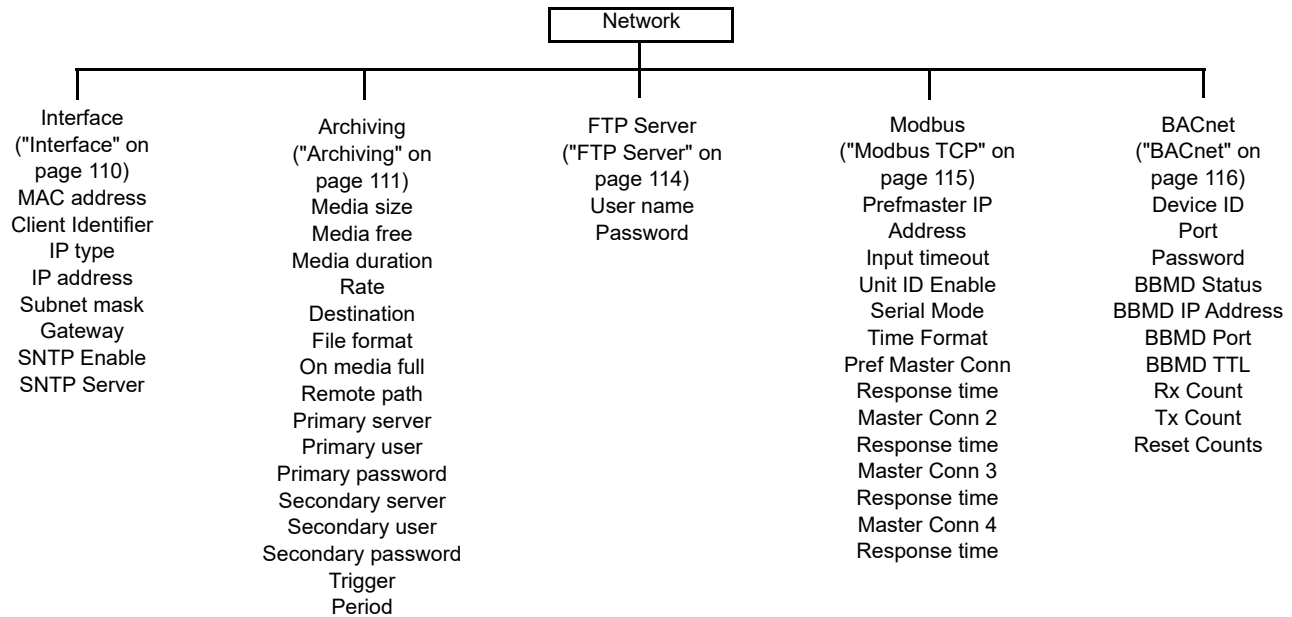

Interface

This area of configuration allows the user to set up an IP address for the instrument, either by typing one in (Fixed), or automatically (DHCP), assuming a DHCP server is running.

Network.Interface	
MAC	00:0A:8D:01:90:00
Client identifier	01000A8D019000
IP Type	DHCP
IP Address	123.123.123.123
Subnet Mask	255.255.248.0
Gateway	234.234.234.234
SNTP Enable	Yes
SNTP Server	192.168.111.123

Figure 81 Network Interface menu

MAC	Read only. Media Access Control. A unique address for each instrument, entered at the factory.
Client Identifier	The client identifier is a unique id used by DHCP servers that implement option 61. Each nanodac product will have a unique ID built up from its MAC address. If the DHCP server is configured to use option 61, then it will use this ID instead of the MAC address to assign a dynamic IP address.
IP Type	If 'Fixed', the user needs to enter an IP address and Subnet Mask in the following fields, and a Gateway address if required. If 'DHCP' the subsequent fields become read only, with the entries automatically generated by the DHCP server. When set to DHCP, it takes several seconds before the IP address is obtained from the DHCP server.
IP Address	Read only if 'IP Type' = 'DHCP'. If 'IP Type' = 'Fixed', the user may enter an IP address (IPV4 dot notation). This would normally be supplied by the user's IT department, or from the Network supervisor.
Subnet Mask	Read only if 'IP Type' = 'DHCP'. If 'IP Type' = 'Fixed', this sets a range of IP addresses that can be accessed. Normally supplied by the user's IT department, or from the Network supervisor.
Gateway	Read only if 'IP Type' = 'DHCP'. If 'IP Type' = 'Fixed' this allows the user to enter a gateway address for use when the unit is to communicate outside the local network. Normally supplied by the user's IT department, or from the Network supervisor.
SNTP Enable	Select 'Yes' to allow time synchronisation from a Simple Network Time Protocol (SNTP) server to be enabled. When enabled the instrument time is updated every 15 minutes. SNTP always works using UTC/GMT. Time zones are handled separately. SNTP is a protocol that allows clients on a TCP/IP network to synchronise the instrument clock with that of a server - port number 123. nanodac can act only as a client. Servers such as Microsoft 'TimeServ' cannot be used with the nanodac because they are not SNTP servers. The SNTP client used in nanodac will not support stratum

SNTP Server

The IP address of the SNTP Server. This only appears if the SNTP server is enabled.

If 'IP Type' is set to 'DHCP', the SNTP Server address is automatically assigned. Although this address can be altered it will be overwritten once the instrument is power cycled. The SNTP address should only be entered manually if 'IP Type' is set to 'Fixed'.

For a description of SNTP alarms see "Status Bar Icons" on page 38.

Archiving

This area of configuration is used to set up the parameters for use during unattended archiving. Some of the fields appear only if other fields are set to a particular value. For example, the CSV fields appear only if 'File Format' is set to 'CSV' or to 'Both'.

The archived data is not removed from the flash memory of the instrument. When the flash memory is full, new data causes the oldest file(s) to be discarded.

Note: For remote archiving, the host computer must be set up to respond to 'pings'. This is because the nanodac pings the host whilst establishing connection, and if it does not receive a response, the archive attempt fails.

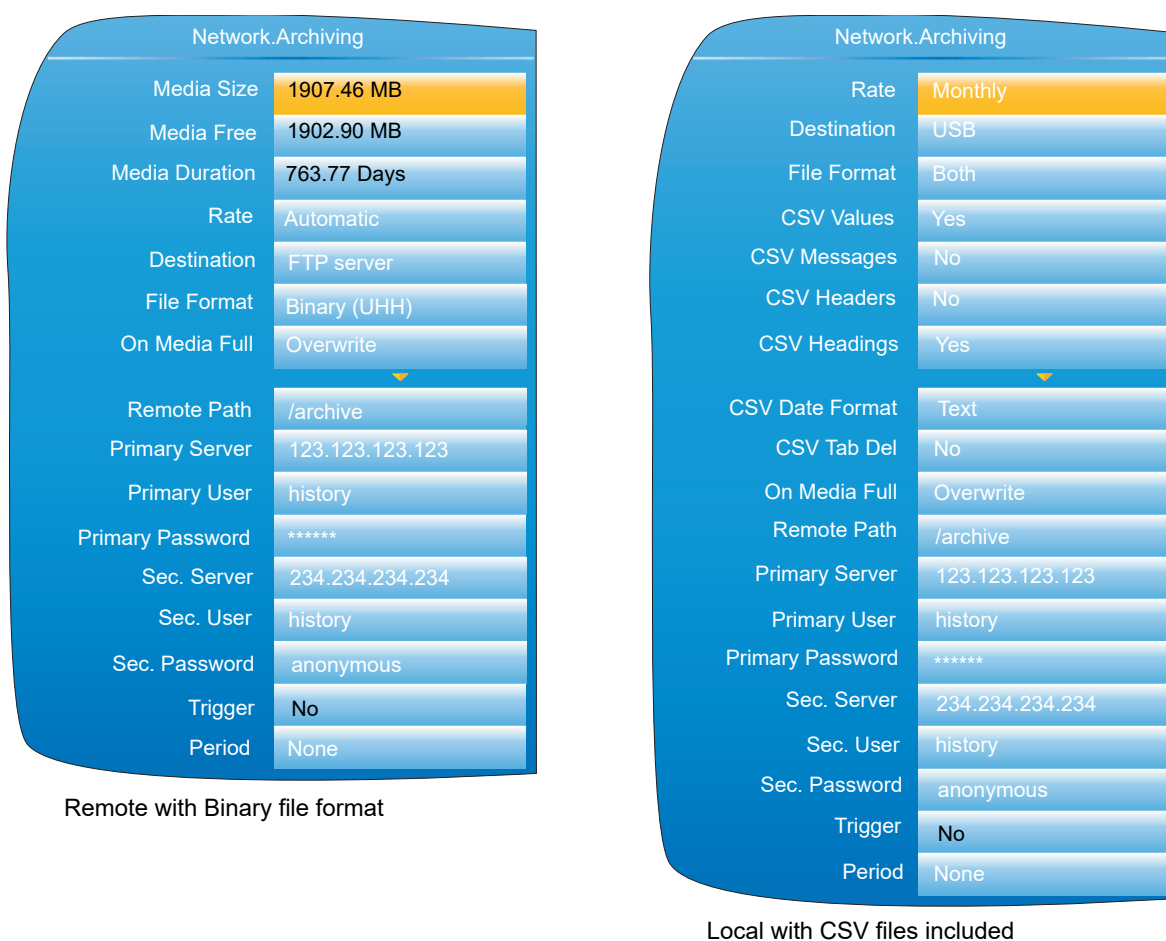

Figure 82 Unattended Archive configuration (typical settings)

Media Size	Appears only for File Format = 'Binary (UHH)'. A read only value showing the capacity of the memory stick inserted in the USB port at the rear of the unit. Shows zero if no memory stick is present.
Media Free	Appears only for File Format = 'Binary (UHH)'. A read only

	serted in the USB port at the rear of the unit. Shows zero if no memory stick is present.
Media Duration	Appears only for File Format = 'Binary (UHH)'. A read only value showing the time it will take to fill the Memory stick if the instrument configuration remains unchanged.
Rate	Allows the user to specify the frequency at which the contents of the Flash memory are archived to the USB port or, via FTP, to a PC. Scrollable settings are: None: Automatic archiving is disabled. Any archiving must be initiated by the user using Demand Archiving, as described in "Demand Archiving" on page 46. Hourly: Archive occurs on the hour, every hour. Daily: Archive initiated at 00:00* each day. Weekly: Archive is initiated at midnight* every Sunday. Monthly: Archive is initiated at 00:00* on the 1st of every month. Automatic: The instrument selects the least frequent of the above archive periods which is guaranteed not to lose data as a result of the internal flash memory's running out of space.

Note: * Archive times are not adjusted for daylight saving time (DST). Thus, if the archive is set to 'Daily', 'Weekly' or 'Monthly', then during summer time, the archive will be triggered an hour late (i.e at 01:00 hours instead of midnight).

Destination	Select 'FTP Server' for archive to a remote PC, or 'USB' to archive to the USB port device.
File format	Select 'Binary (UHH)' 'CSV' or 'Both'. Binary (UHH): A proprietary format used by the instrument that needs other software (e.g. Review', to interpret the data before it can be presented in spreadsheets etc. Binary files have the extension '.uhh'. CSV: This format is a standard open-file format for numeric data. A simple ASCII-based format, it is readable by a wide range of pc applications as well as being suitable for direct import into many commercial databases. CSV files have the extension '.csv'. Both: Archiving includes both .uhh and .csv files.

Note: Note: CSV is ASCII based and cannot interpret Unicode characters. For this reason, some characters available to the user will not be displayed correctly in *.csv files.

CSV Values	Appears only if 'File Format' is set to 'CSV' or 'Both'. If 'Yes' is selected, then process values are included in the file (see Figure 83 for details).
CSV Messages	Appears only if 'File Format' is set to 'CSV' or 'Both'. If 'Yes' is selected, then messages are included in the file (see Figure 83 for details).
CSV Headers	Appears only if 'File Format' is set to 'CSV' or 'Both'. If 'Yes' is selected, then Header details are included in the file (see Figure 83 for details).
CSV Headings	Appears only if 'File Format' is set to 'CSV' or 'Both'. If 'Yes' is selected, then column headers are included in the file (see Figure 83 for details).
CSV Date Format	Appears only if 'File Format' is set to 'CSV' or 'Both'. Allows 'Text' or 'Spreadsheet' to be selected. Text causes a time/date to appear in the spreadsheet. 'Spreadsheet Nu' displays the number of days since December 30th 1899. The decimal part of the number represents the latest six hours. For example: DDD--- --DD.25 represents 06:00 hours and DDD--- --DD.5 represents 12:00 hours. Spread-

	sheet Numeric format is more easily interpreted than 'Text' by some spreadsheet applications.
CSV Tab Del	Appears only if 'File Format' is set to 'CSV' or 'Both'. CSV (Comma Separated Variables) does not always use commas as separators. For example, in some countries the decimal point is represented by a full stop (period), whilst in others a comma is used. In order to avoid confusion between a comma as a decimal point and a comma as a separator, a different separator can be used. This field allows the 'tab' character (^t) to be used instead of a comma.
On Media Full	For 'Destination' = 'USB' only, this allows the user to select 'Overwrite' or 'Stop' as the action to be taken when the memory stick is full. 'Overwrite' causes the oldest data to be discarded from the memory stick to make room for newer data. 'Stop' inhibits archiving activity.
Remote Path	Left blank if the archive destination is the home folder. If the destination is to a subfolder within the home folder, then the name of the subfolder is entered here, preceded by a '/' character (e.g. '/history').
Primary Server	Allows the user to enter the IP address for the PC to be used as the primary FTP server.
Primary User/Password	These are the Login name and password of the remote host account, assigned either by the Network administrator, or set up in the 'Guest' account of the remote host's 'FTP server' or 'User Manager' configuration.
Sec. Server/user/password	As Primary server details above, but for the secondary FTP server used when the primary is not available for any reason.
Trigger	This parameter can be 'wired' to, say, an alarm going active, or a digital input, to allow an archive to be triggered remotely. Can also be set to 'yes' manually.
Period	Appears only if 'Trigger' is wired ("iTOOLS"). Allows a period of history to be selected for archiving when 'Trigger' goes 'true'. Selections are: None, Last Hour, Last Day, Last Week, Last Month, All, Bring to Date. ('Last Month' archives the last 31 days of history.)

Click/drag separator to edit field width

A1	A	B	C	D	E	F	G	H	I	J	K	L	M	N	O
1	Instrument	Name=	Distil temp		Serial Num	9921		Software V	4.0		Timezone=	GMT			
2		Mac Addr	00:AB:8D:30:26:C0		Language=	en		Country=	GB						
3	Group Name	Tank Temp													
4	Tank1 Tem	Low=	0	High=	40	-C									
5	Tank1 Tem	Low=	0	High=	40	-C									
6	Tank1 Tem	Low=	0	High=	40	Deg C									
7	Tank2 Tem	Low=	0	High=	40	Deg C									
8	Tank2 Tem	Low=	0	High=	40	Deg C									
9	Tank2 Tem	Low=	0	High=	40	Deg C									
10	Difference	Low=	-20	High=	+20	Deg C									
11	Date/Time	Tank1 Tem	Tank1 Tem	Tank1 Tem	Tank2 Tem	Tank2 Tem	Tank2 Tem	Difference							
12		-C	-C	Deg C	Deg C	Deg C	Deg C	Deg C							
13	09.39.0	23.49	23.74	24.01	31.2334	29.7693	30.0983	6.61							
14	09.44.0	23.53	23.70	23.88	30.6458	29.0673	29.9083	6.13							
15	09.49.0	23.57	23.68	23.91	30.0945	28.8936	29.9083	5.91							
16	09.54.0	23.50	23.69	23.99	31.1437	29.4387	30.0235	6.47							
17	09.59.0	08/04/05	14:09:54	Alarm off											
18	End of Archive														

Include header details

Include column headings

Include values

Include messages

Right click, then:
Format cells...
select 'time' as number category
Select time/date 'type' as required.

Tank Temps--8026C026000002A9 /

Ready

Figure 83 CSV data example

FTP Server

This area of configuration allows the user to enter the Username and Password used to access the instrument from a remote FTP client.

Modbus TCP

This allows the user to configure the instrument so as to allow it to communicate using Modbus Transmission Control Protocol.

Network.Modbus	
PrefMaster IP	123.123.123.123
Address	1
Input Timeout	0 sec
Unit ID Enable	Instrument
Serial Mode	Modbus Slave
Time Format	Seconds
PrefMaster Conn	123.123.123.123
Response Time	0
Master Conn 1	0.0.0.0
Response Time	0
Master Conn 2	0.0.0.0
Response Time	0
Master Conn 3	0.0.0.0
Response Time	0
Master Conn 4	0.0.0.0
Response Time	0

Figure 84 Modbus TCP configuration menu

PrefMaster IP	The IP address of the relevant Modbus master. The Preferred master is guaranteed to be able to connect, even if all slave connections (max. = 4 for TCP) are in use.
Address	The Modbus address for this slave. This address must be unique for the network to which it is attached. The instrument will respond to this address and to Address 255.
Input Timeout	Allows a value of between 0 and 3600 seconds to be entered to set the timeout period for modbus input channels. If a Modbus input is not written to within this period the value of the channel is set to -9999.0 with a 'No Data' status. A value of 0 disables the comms inactivity timeout feature.
Unit ID Enable	Enables/Disables the checking of the Modbus TCP unit identity field. Strict The Modbus TCP Unit Identity Field (UIF) does not have to match the instrument address. The instrument responds only to Hex value FF in the UIF. iTools finds this instrument only at location 255, and then stops scanning. Loose The Modbus TCP Unit Identity Field (UIF) does not have to match the instrument address. The instrument responds to any value in the UIF. Instrument The Modbus TCP Unit Identity Field (UIF) must match the instrument address or no response will be made to messages.
Serial Mode	Slave communications via the side mounted configuration port interface (CPI) clip (for iTools use.) Parameters: Baud rate = 19,200; Parity = none; Number of data bits = 8; Number of stop bits = 1; no flow control. Can be set to 'Modbus Slave' or 'Off'. The unit must be restarted before any change takes effect.

Time Format	Allows the user to choose milliseconds, seconds, minutes or hours as the time format. Sets the resolution for the reading and writing of time format parameters.
PrefMaster Conn	Read only. Shows the IP address of the preferred master, when connected.
Response Time	Read only. Shows the response time for a single communications request to the relevant master.
Master Conn 1 to 4	Read only. Shows the IP addresses of any other masters connected to this instrument.

BACnet

This allows the user to configure the instrument so as to allow it to be used as a BACnet device on a BACnet/ IP BMS network.

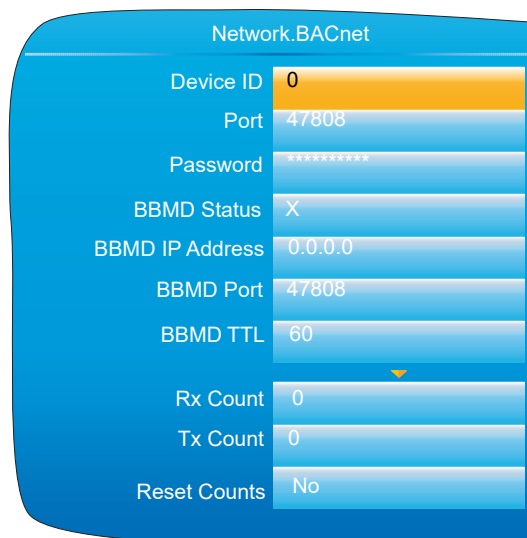

Figure 85 BACnet configuration menu

Device ID	The instance ID for this instrument. Must be unique on the network. Range is 0 - 4194302.
Port	The BACnet I/P standard port is 47808. Valid values are: 1024 -65535.
Password	The BACnet password for Remote Device Management. Maximum 20 characters.
BBMD Status	Enable or disable registration of the instrument as a foreign device. Default is 'x' (disabled).
BBMD IP Address	The IP address of this instrument as a BACnet/IP Broadcast Management Device. Default is 0.0.0.0.
BBMD Port	The port this instrument communicates through as a BACnet/IP Broadcast Management Device. Standard Port is 47808. Range is 1024 - 65535.
BBMD TTL	The Time to Live for this instrument as a BACnet/IP Broadcast Management Device. The default value is '60'. Range is 0 - 65535.
Rx Count	A count of messages received.
Tx Count	A count of messages transmitted.
Reset Counts	Set to 'Yes' and the Rx and Tx Counts are reset to zero. Once the counts are reset, this option reverts to 'No'.

Group Configuration

Group configuration is separated into two areas, one which defines trending characteristics (for display channels) the other defining the recording characteristics for saving data to the Flash memory ready for archiving.

Group Trend configuration

This allows the user to define which points are to be traced on the display and at what interval, and also allows the number of chart divisions to be set up. Figure 86 shows a typical configuration page.

Note: The background chart colour is set up as a part of Instrument Display configuration ("Display configuration" on page 94).

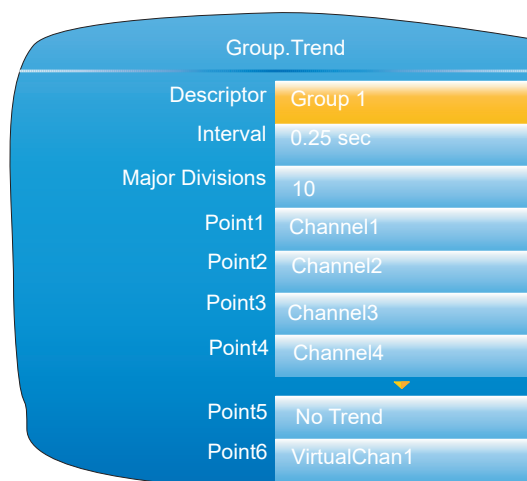

Figure 86 Group Trend Configuration

Descriptor	Allows the user to enter a descriptor (20 characters max.) for the group.
Interval	The trending interval which defines how much data appears on one screen height or width. A number of discrete intervals can be chosen between 0.125 seconds to 1 hour. The selection should be made according to how much detail is required, and how much data is to be visible on the screen.
Major Divisions	Allows the user to select the number of divisions into which the scale is divided and how many gridlines are displayed. Setting the value to 1 results in just the zero and full scale values appearing. Setting the value to 10 (the maximum) results in a scale with zero, full scale and nine intermediate values appearing, with associated grid lines.
Point1 to Point6	Allows the user to select which channels and virtual channels are to be traced. The maximum number of traces is six.

Group Recording configuration

Similar to Trend configuration, above, but for saving the data to Flash memory history files. Each point can individually be enabled or disabled for recording, or recording can be disabled for the whole group.

Figure 87 shows a typical page.

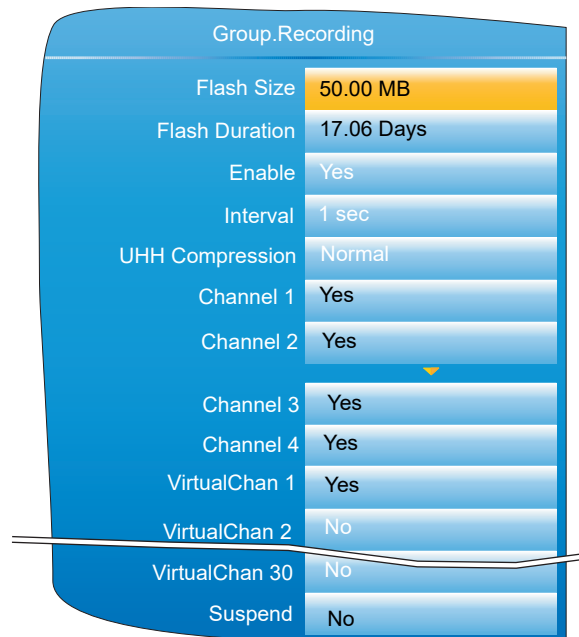

Figure 87 Group trend recording configuration

Flash Size	Read only. Shows the size of the Flash memory fitted in MB.
Flash Duration	Read only. Shows the time it will take to fill the Flash memory if the instrument configuration remains unchanged.
Enable	'Yes' enables group recording so that all points set to 'Yes' are stored in the instrument's flash memory. 'No' disables group recording.
Interval	Defines the rate at which data is saved to the instrument's Flash memory. The value affects how much trace history appears on the screen in trend history mode.
UHH Compression	Select 'Normal' or 'High'. 'Normal' compresses the data, but still provides an exact copy. 'High' compresses more, but values are saved only to 1 part in 10 ⁸ resolution. See also note 1, below.
Channel 1 to VirtualChan 30 (see note 2, below)	Read only (greyed 'yes') for points being trended, (these are automatically recorded). For non-trending points the user may enable or disable each point individually.
Suspend	Ignored unless the user has wired to this field. If wired then when set to 'No' recording is active, when set to 'Yes' recording is paused.

Notes:

- Where very high values are involved, such as in some totaliser values, 'High' compression may cause the value displayed at the instrument, and held in the history file, to be incorrect. The problem may be resolved by changing to 'Normal' compression, or, in the case of a totaliser, by re-scaling it (for example from MegaWatt hours to TeraWatt hours).
- Virtual channels 1 to 15 are included in the standard build. Channels 16 to 30 are included only if the Modbus Master and/or EtherNet/IP option is fitted.

Batch Configuration

Batch records form a part of recording history and are identified by messages that are written to the history file indicating when a batch starts and ends, along with additional customisable textual information. Batches can be initiated directly by the operator, automatically whenever a specific PV value is reached, or remotely via Modbus.

Batches can be defined as Start/Stop or Continuous. For Start/Stop batches, the batch record starts when the batch is started and continues until it is stopped. For continuous batches, the batch record starts when the batch is started and continues until the next batch is started, or until batch recording is disabled.

When a batch is started, a start message is included in the history in the format:

```
DD/MM/YY HH:MM:SS Batch Start <User>
```

where DD/MM/YY is the date, HH:MM:SS is the time, and <User> is the current user name, security level (Engineer, for example), or 'Modbus' if initiated remotely). A similar message is written to the history when the batch is stopped. There are no stop messages written if the batch is in Continuous mode.

In addition to the above Start/Stop messages, up to six lines of text can, if required, be written to the history at the start of a batch, and, if required, at the end of the batch. The messages are in two parts, the field descriptor, and the field value. The field descriptors are entered in the parameters 'Field 1' to 'Field 6' in the Batch Configuration menu. The field values associated with these descriptors are entered by the operator at initiation. The field descriptors and content can be used to label the batch with identifiable information, such as the batch number, customer name, and so on. The use of 'Field 1' is mandatory for a batch to be started, and is unique because this particular field can also have an automatically populated PV value if configured in this way.

The following shows the options in the Batch Configuration menu. Note that some options will not be available depending on the security level of the logged on user.

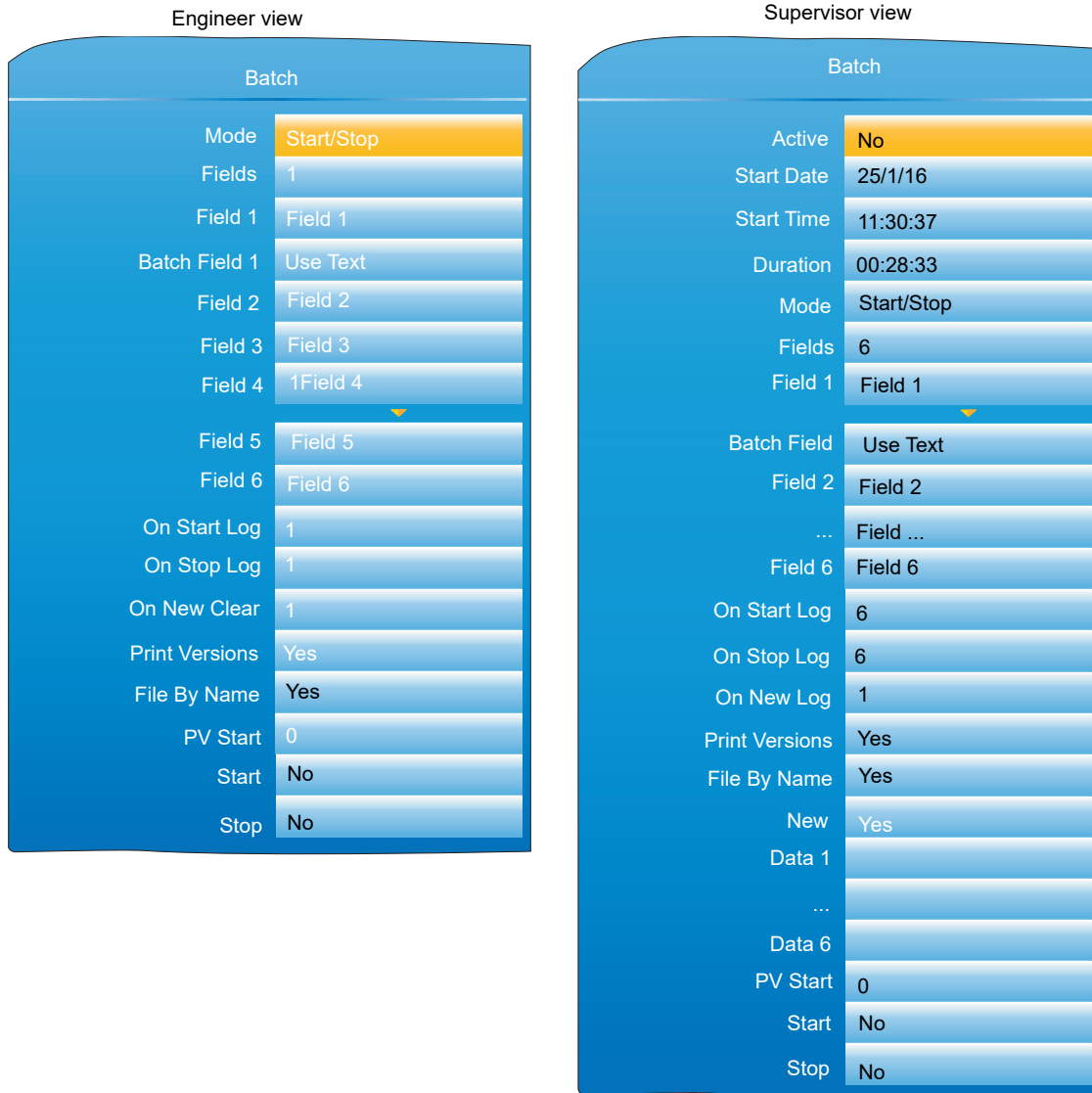

Figure 88 Batch configuration menu

- Active Read-only field showing whether batch is currently running.
- Start Date Read-only field showing the date the batch was started, or the last date the batch was started if a batch is not currently active.
- Start Time Read-only field showing the time the batch was started, or the last time the batch was started if a batch is not currently active.
- Duration Read-only field showing the length of time the current batch has been running, or the length of time the last batch ran for if a batch is not currently active.
- Mode Determines whether a batch process runs once after starting, stopping when the batch ends ('Start/Stop'), or runs continuously ('Continuous').
- Fields Specifies how many messages (between one and six) can be written to the history file at batch start, stop and new. For each field, customised field descriptors can be set using the 'Field 1' to 'Field 6' parameters. The value (content) of each field can be entered when a new batch is initiated. Field 1 can be set to automatically contain the current PV at batch start (see 'Batch Field 1' parameter below).
- Field 1-6 Allows the user to enter customised text for the field de-

	start, stop and new. Values for these fields descriptors must be entered by the user prior to Batch initiation. The number of Field lines is dependent upon the value in the 'Fields' parameter. A maximum of 20 characters per field is allowed.
Batch Field 1	Determines whether the value (content) associated with 'Field 1' should use the text de-fined in the Field 1 parameter when the batch starts ('Use Text'), or whether the value should be the PV value at batch start ('Use PV Start').
On Start Log	Defines how many of customised fields (Field 1 to Field 6) are written to the history file at batch start. An entry of '1' means that only Field 1 will be written. An entry of '2' means that Fields 1 and 2 will be used, and so on. An entry of '0' means that only the 'Batch Start' message is written. It is not possible to record, only, Field 3, for example. If Field 3 is required, it will be preceded by Fields 1 and 2.
On Stop Log	As fir the On Start Log parameter above, but for batch stop. This item appears only if Start/ Stop is selected as the batch mode ('Mode' parameter).
On New Clear	This parameter determines how many Field values are cleared when a new batch is initiated. For example, if Field 1 were used to record a batch number, and Field 2 were used to record the customer name, a value of '1' in the parameter will force the user to enter the batch number (Field 1 descriptor) at each new batch instance. If this parameter were set to '2', the user would have to enter the batch number and customer number at each new batch instance. In each case, a new batch cannot be started without new values first being entered. A value of '0', however, clears no existing fields, and a new batch can be started without any additional entry of field values.
Print Versions	Determines whether the configuration and security revision numbers are written to the history file when a batch starts.
File By Name	As an aid to identification, if this parameter is set to 'Yes', the value of the Data 1 parameter (see below) is inserted into the history file name. For example, if the contents of the Data 1 parameter were "BAT060515.001", then the file name will appear in the form: Group Name~060515.001~YYYYMMDD_HHHHHHHHHH-HHHHHHHH where YYYYYYMMDD is the date and HH...HH is a 16 digit hex code used by the instrument and by the Review software to identify the file. If the File By Name parameter is set to 'No', the file history file name appear as: Group Name~YYYYMMDD_HHHHHHHHHHHHHHHHHH New This field is only accessible when no active batch is running and you are logged on as a supervisor. Setting this field to 'Yes' will initialise a new batch and clear the parameters Data 1 to Data 6 depending on the value of parameter, On New Clear, above. A new batch must be initialised before the ability to Start a new batch is available. The user must ensure that all Data 1 to Data 6 fields (where applicable) have values in them before being able to start a new batch.
Data 1 - Data 6	When a new batch is initialised (using the New parameter above), the content of these fields are cleared according to the On New Clear parameter, above, and new values can be input by the user. A batch cannot be started until the Data 1 to Data 6 fields have content in them, which are the values assigned to the Fields 1 to 6 descriptors. These are

	generic or specific information that will be written to the history file upon batch start and stop. The number of Data fields presented is controlled by the value in the Fields parameter, above.
PV Start	Defines the PV at which the Batch process should start. This field is only visible when the Batch Field 1 is set to 'Use PV Start'.
Start	Starts the batch process. This field is only available when signed in as a Supervisor and, at the very least, the 'Data 1' parameter has content defined. This field is not visible when the Batch Field 1 is set to 'Use PV Start', as the batch process starts automatically at a defined PV.
Stop	Stops the batch process. This field is only available when signed in as a Supervisor and a batch is currently running. This field is not visible when the batch Mode is set to 'Continuous'.

Initiating a new Batch

This section describes how the user initiates a new batch, and assumes batch options have already been configured (see "Batch Configuration" on page 119). Initialising a batch does not, in itself, start a new batch. Instead, initialising a new batch sets all the parameters in a state ready for batch to be started, which can then be done manually, automatically based on a PV value, or over Modbus.

To initiate a batch, a user with appropriate permissions needs to be logged in. This typically means the Supervisor user, or if the Auditor feature is enabled, then any user account that has Batch permission granted to it. Note that the Engineer user cannot initiate, start or stop a batch.

Once logged in, the user can initiate a new batch by using the Batch Control page (see "Batch Control" on page 76) or the Batch Configuration page ("Batch Configuration" on page 119). In either page, scroll to the 'New' field and change the value to 'Yes'. All, some or none of the Data fields will be cleared (from the value they last held) depending on the value of the 'On New Clear' parameter in the Batch Configuration menu.

Populate the Data fields as appropriate. These fields are used to store specific batch-related information, the content of which are appended to the history file. Unless the batch is configured to start when a specific PV value is reached, at least the first Data field must be populated.

For instances where batch is configured to start at a specific PV value, set the 'PV Start' to the desired PV start value. This value is copied to the first Data field automatically when the batch starts so it is recorded in the History file.

Starting a Batch

Once a new batch has been initialised (see the previous section, "Initiating a new Batch" on page 122). The batch can be started (assuming the batch Mode is defined as 'Start/Stop' and not 'Continuous').

If the batch has not been configured to start when PV reaches a specific value, navigate to the Start parameter and change the value to 'Yes'. The batch then starts.

If the batch has been configured to start when PV reaches a specific value, initialising the batch is all that is needed for a batch to be armed to start at the appropriate PV.

No further action is required.

The batch can also be started (and stopped) by utilising User Wiring, linking another parameter to 'Batch Start' or 'Batch Stop'. Refer to Section 10 for further details of User Wiring.

Starting a Batch using Modbus

It is possible to start a Batch via Modbus by setting the Batch Start flag to 0001 at Modbus address 0x3058. If the Batch mode is 'Start/Stop', batches can also be stopped via Modbus by setting the value 0001 at address 0x3059. For a list of all Modbus addresses relating to Batch, refer to the BatchSection Batch sub-section within "Parameter List" on page 232.

Input Channel Configuration

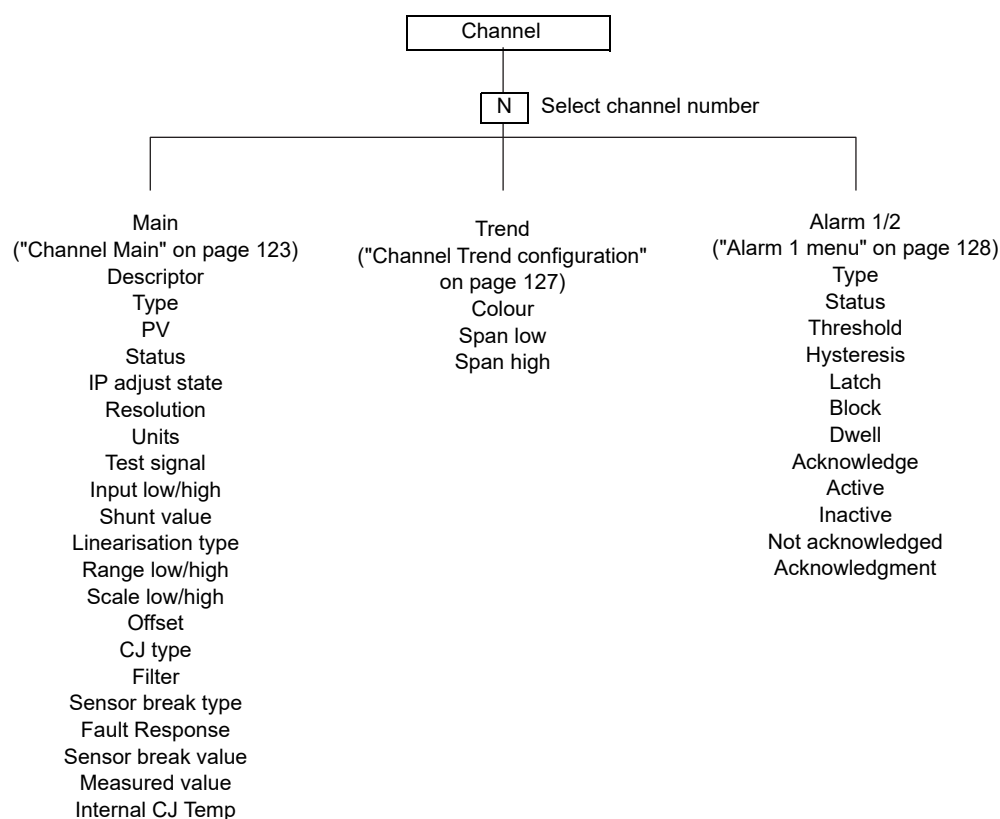

Figure 89 Channel configuration menu

Channel Main

This section describes all possible menu items, but it should be noted that some items are context dependent (e.g. Cold Junction settings appear only for Type = 'Thermocouple').

Channels one to four in the configuration relate to An In 1 (terminals 1I, 1+ and 1-) to An In 4 (terminals 4I, 4+ and 4-) respectively -see [Figure 4](#), in Section "Installation".

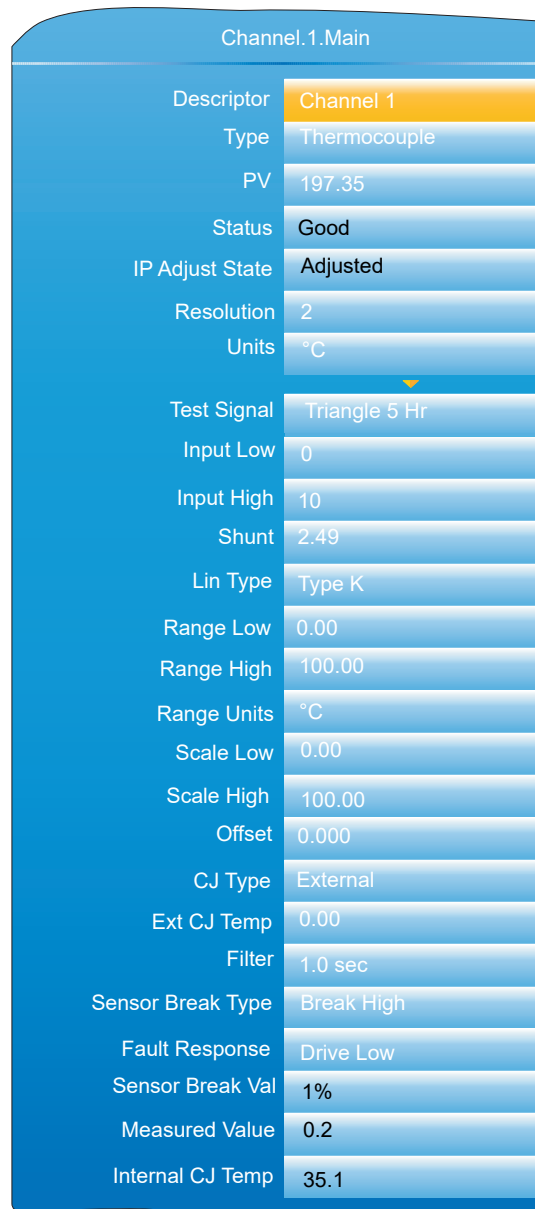

Figure 90 Channel main menu (expanded)

Note: For the sake of completeness, the figure above shows all possible fields, even though many are mutually exclusive. For example, ‘Test signal’ appears only when ‘Test’ is selected as Type. It would never appear when Type = thermocouple (as shown). Similarly, ‘Shunt’ would appear only for Type = mA.

Descriptor	Allows a (20 character max.) descriptor to be entered for the channel. Some thought should be given to ensure that the descriptor is meaningful because in some display screens it is truncated. For example, ‘Furnace 1 area 1’ and ‘Furnace 1 area 2’ might both appear as ‘Furnace 1 a’ and thus be indistinguishable from one another, except in background colour.
PV	Read only. Displays the current value of the channel.
Status	Read only. Shows the channel status as one of: ‘Good’, ‘Channel Off’, ‘Over range’, ‘Under range’, ‘HW error’, ‘Ranging’, ‘HW (capability) exceeded’.
PV2	Read only. For dual inputs only, displays the current value of the secondary input.
Status2	Read only. For dual inputs only, shows the secondary input status (see ‘Status’ above).

IP Adjust State	Appears only for channels which have been included in the 'Adjust Input' procedure described in "Input adjust" on page 103.
IP Adjust State2	As 'IP Adjust State', above but for secondary channels.
Resolution	Allows the number of decimal places to be defined for the channel. Valid entries are zero to six.
Units	Allows a units string of up to five characters to be entered.
Type	Allows the user to select an input type for the channel. Available selections are: 'Off', 'Thermocouple', 'mV', 'V', 'mA', 'RTD', 'Digital', 'Test' or 'Ohms'. If the Dual Input option is fitted, Dual mV, Dual mA, Dual T/C (if enabled) are also available.

Note: If Dual T/C is selected then it is essential that the secondary T/C input is field calibrated using the Input Adjust procedure ("Input adjust" on page 103)

Test signal	Appears only if 'Test' is selected as 'Type'. Allows either a sinusoidal or a triangular waveform to be selected at one of a number of cycle times between 40 seconds and five hours.
Input Low*	For Type = mV, Dual mV, V, mA, Dual mA or Ohms, the lowest value of the applied signal in electrical units.
Input High*	As 'Input Low', but the highest value of the applied signal in electrical units.
Shunt value	For mA and Dual mA input types only, this allows the value of the shunt resistor (in Ohms) to be entered. The instrument does not validate this value -it is up to the user to ensure that the value entered here matches that of the shunt resistor(s) fitted. For Dual mA input type, both primary and secondary inputs must have independent shunts each of the same value.
Lin type	Linear, Square root, x3/2, x5/2, User Lin. Thermocouple types (alphabetical order): B, C, D, E, G2, J, K, L, N, R, S, T, U, NiMo/NiCo, Platinel, Ni/MiMo, Pt20%Rh/Pt40%Rh. User 1 to User 4 Resistance thermometer types: Cu10, Pt100, Pt100A, JPT100, Ni100, Ni120, Cu53. See Appendix A: TECHNICAL SPECIFICATION for input ranges, accuracies etc. associated with the above thermocouple and RTD types. See "User LIN" on page 197 for details of user linearisations.
Range Low*	For thermocouples, RTDs, User linearisations and retransmitted signals only, the lowest value of the required linearisation range.
Range High*	For thermocouples, RTDs, User linearisations and retransmitted signals only, the highest value of the required linearisation range.
Range Units	For thermocouples only and RTDs, Select °C, °F or K.
Scale Low/High	Maps the process value to (Scale High - Scale Low). For example, an input of 4 to 20mA may be scaled as 0 to 100% by setting Scale Low to 0 and Scale High to 100.
Scale Low2/High2	As 'Scale Low/High' but for the secondary input (PV2).
Offset	Allows a fixed value to be added to or subtracted from the process variable.

Note: * See "User LIN" on page 197 for details of the configuration of Range High/Low and Input High/Low when 'Type' = User 1 to User 4.

Offset2	The nature of the secondary input results in an offset being introduced into the process variable value.
---------	--

user intervention.

For mV inputs the offset depends on the value of the voltage source impedance and is equal to $199.9\mu V/\dots$. This offset can be compensated for either by using this Offset2 parameter, or by carrying out the 'Input Adjust' procedure ("Input adjust" on page 103).

For Dual T/C inputs, it is recommended that the 'Input Adjust' procedure be used instead of Offset2 as the use of Offset2 results in an offset which is non-linear over the thermocouple range.

Input filter

Damping can be used to filter out noise from slowly Input changing signals so that the underlying trend can be seen more clearly. Valid input values are between 0 Instrument and 60 seconds.

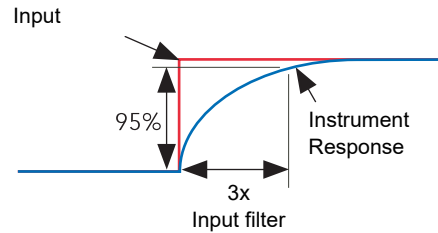

Note: Applying a filter to an input channel can affect the operation of any Rate-of-change alarms configured to act on that channel.

CJC Type

For thermocouple input types only, this allows the user to select 'None', 'Internal', 'External' or 'Remote 1' to 'Remote 4'. For Dual T/C inputs, both primary and secondary inputs use the same cold junction. None: No Cold junction compensation applied. 'Internal' uses the instrument's internal cold junction temperature measurement. 'External' means that the cold junction is to be maintained by the user, at a fixed, known temperature. This temperature is entered in the 'External CJ Temp' field which appears when 'External' is selected. Remote 1 (2) (3) (4) means that the cold junction temperature is being measured by input channel 1 (2) (3) (4) respectively. (This must be a different channel from that currently being configured).

Ext. CJ Temp

Appears only if CJC type is set to 'External', and allows the user to enter the temperature at which the external cold junction is being maintained.

Sensor Break Type

Defines whether the sensor break becomes active for circuit impedances greater than expected. 'Off' disables Sensor Break detection.

Break Low: Sensor break active if measured impedance is greater than the 'Break Low impedance' value given in [Figure 91](#).

Break High: Sensor break active if measured impedance is greater than the 'Break High Impedance' value given in [Figure 91](#).

For mA inputs, limits are applied, such that if the process value lies outside these limits, a sensor break is assumed to have occurred. These limits are (Input lo - 4% Span) and (Input high + 6% Span). For example, for a 4 to 20mA signal, an input below 3.36mA or above 20.96mA will trigger a sensor break event.

Range	Break Low impedance	Break High Impedance
40mV	~5kΩ	~20kΩ
80mV	~5kΩ	~20kΩ
2V	~12.5kΩ	~70kΩ
10V	~12.5kΩ	~120kΩ

Figure 91 Minimum impedances for sensor break detection

Note: Break High impedance values would be used typically for sensors which have a high nominal impedance when working normally

Input sensor break detection is not supported for secondary inputs. The internal circuit acts as a 'pull up' on the secondary input which therefore saturates high in the event of a sensor break.	
Fault Response	Specifies the behaviour of the instrument if a sensor break is detected or if the input is over driven (saturated high or low). 'None' means that the input drifts, with the wiring acting as an aerial. 'Drive High' means that the trace moves to (Scale High +10%). 'Drive Low' means that the trace moves to (Scale Low -10%), where the 10% values represent 10% of (Scale High - Scale Low).
Sensor Break Val	A diagnostic representation of how close the sensor break detection circuitry is to tripping.
Measured Value	The (read only) input channel measured value before any scaling or linearisation is applied.
Measured Value2	As 'Measured Value', above but for the secondary input.
Internal CJ temp	The (read only) temperature of the internal cold junction associated with this channel.

Channel Trend configuration

This area allows the configuration of channel colour and span.

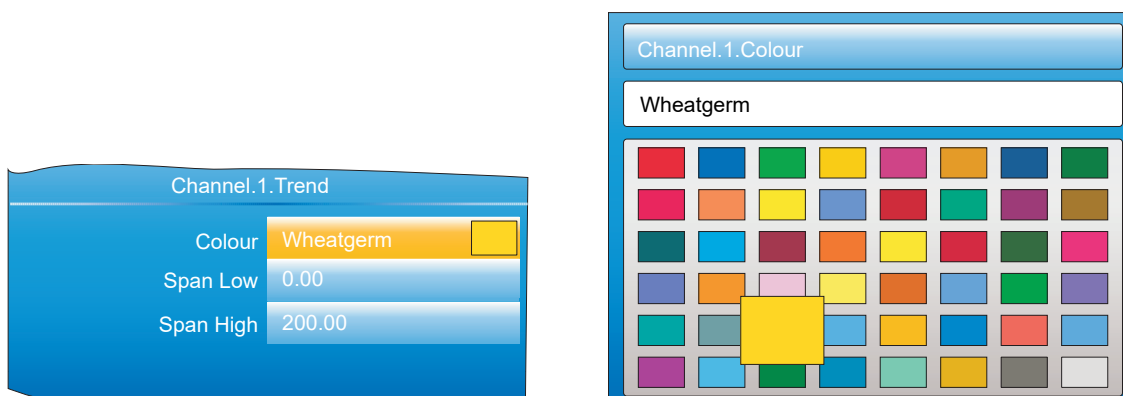

Figure 92 Channel Trend menu and Colour selection

Colour	Allows a colour to be specified for the channel. The Scroll key is used to enter the colour swatch page. The up and down arrows are used to scroll through the available colours, with each colour being enlarged for as long as it is 'selected'. Once the required colour, is reached, the scroll key is used again to return to the Trend Configuration.
Span Low/High	Span low and high values.

Note: Trend colours and alarm settings for secondary inputs are configured in the maths channels to which they are wired.

Span Example

In an input range of 0 to 600 degrees C, the temperature range between 500 and 600 degrees is of most interest. In such a case, Span Low is set to 500 and Span High to 600 so that the instrument trends only the required part of the temperature range, effectively magnifying the area of interest.

Note: Trending is restricted to the PV range (Span High -Span Low), but the instrument can display values outside this range.

Channel Configuration Example

A type J thermocouple is used to measure a temperature range of 100 to 200 degrees Celsius. This thermocouple output is transmitted to the instrument by a 4 to 20mA transmitter, for display as a value between 0 and 100%.

In Channel.Main, set the following for the relevant channel:

Type = mA

Units = %

Input Low = 4.00

Input high = 20.00

Shunt = 250 Ohms

Lin Type = Type J

Range Low = 100.00

Range High = 200.00

Range Units = °C

Scale Low = 0

Scale High = 100

Other items may be left at their defaults.

Alarm 1 menu

Allows the alarm characteristics for Alarm 1 to be configured. The figure below shows a typical configuration page (expanded for clarity). Actual configuration parameters are context sensitive.

Channel.1.Alarm1	
Type	Abs High
Status	Active Not ackd
Threshold	35.00°C
Hysteresis	5.00°C
Latch	Manual
Block	Off
Dwell	00:00:00
Acknowledge	No
Active	Yes
Inactive	No
N.acknowledged	Yes
Acknowledgement	No
Inhibit	X

Figure 93 Typical alarm 1 configuration menu

Type	Select an alarm type from: 'Off', 'Abs. High' (absolute high), 'Abs. Low' (absolute low), 'Dev. High' (deviation high), 'Dev. Low' (deviation low), 'Dev. Band' (deviation band), 'Rise ROC' (rate-of-change: rising), 'Fall ROC' (rate-of-change: falling), 'Digital High', 'Digital Low'. See 'Alarm types', below, for definitions.
Status	Read only. This shows that the alarm is Off, Active, SafeNotAcked or ActiveNotAcked. For 'Auto' and 'Manual' alarms only, 'SafeNotAcked' means that the alarm trigger source has returned to a non-alarm state, but the alarm is still active because it has not been acknowledged. Similarly, 'ActiveNotAcked' means that the source is still active and the alarm has not been acknowledged. Always shows 'Off' when the alarm is inhibited (see below).
Threshold	For absolute alarms only, this is the trip point for the alarm. For absolute high alarms, if the threshold value is exceeded by the process value (PV) of this channel, then the alarm becomes active, and remains active until the PV falls below the value (threshold - hysteresis). For absolute low alarms, if the PV of this channel falls below the threshold value, then the alarm becomes active and remains active until the PV rises above (Threshold + Hysteresis).
Reference	For deviation alarms only, this provides a 'centre point' for the deviation band. For 'deviation high' alarms, the alarm becomes active if the process value (PV) rises above the value (Reference + Deviation) and remains active until the PV falls below (Reference + Deviation - Hysteresis). For 'deviation low' alarms, the alarm becomes active if the process value (PV) falls below the value (Reference - Deviation) and remains active until the PV rises above (Reference - Deviation + Hysteresis). For 'deviation band' alarms, the alarm is active whenever the process value (PV) lies outside the value (Reference ± Deviation) and remains active until the PV returns to within the band, minus or plus Hysteresis as appropriate.
Deviation	For deviation alarms only, 'Deviation' defines the width of the deviation band, each side of the Reference value, as

Hysteresis	For absolute and deviation alarms, this provides a means of preventing multiple alarm triggering, if the process value is drifting close to the trigger value.
Amount	For rate-of-change alarms only. The alarm becomes active if the process value rises (Rise ROC) or falls (Fall ROC) by more than the specified 'Amount' within the time period defined in 'Change Time', below. The alarm remains active until the rate of change falls below the value (Amount/Change Time) in the relevant sense.
Change Time	Settable to 1 second, 1 minute or 1 hour. See 'Amount' (above).
Average Time	For rate-of-change alarms only. This allows an averaging period (for the process value) to be entered to reduce nuisance trips due to signal noise, or if the rate of change is hovering around the trip value.
Latch	None: The alarm remains active until the monitored value has returned to a non alarm state, when it becomes inactive. Auto: The alarm remains active until the monitored value has returned to a non alarm state and the alarm has been acknowledged. Acknowledgement can take place either before or after the value has returned a non alarm state. Manual: The alarm remains active until the monitored value has returned to a non alarm state and the alarm has been acknowledged. Acknowledgement is permitted only after the value has returned a non alarm state. Trigger: Not enunciated, this mode is used only to initiate an action defined by user wiring either using iTools or using the user interface.
Block	Alarms with 'Block' set to 'On' are inhibited until the monitored value has entered the 'safe' condition after a start-up. This prevents such alarms from becoming active whilst the process is brought into control. If a latching alarm is not acknowledged then the alarm is re-asserted (not blocked), unless the alarm's threshold or reference value is changed, in which case the alarm is blocked again.
Dwell	Initiates a delay between the trigger source becoming active, and the alarm becoming active. If the trigger source returns to a non alarm state before the dwell time has elapsed, then the alarm is not triggered and the dwell timer is reset.
Acknowledge	Select 'yes' to acknowledge the alarm. Display returns to 'No'.
Active	Read only. Shows the status of the alarm as 'Yes' if it is active, or No, if inactive. The active/inactive state depends on the Latch type (above) and acknowledgment status of the alarm. Always shows 'No' if the alarm is inhibited (below).
Inactive	As for 'Active' above, but shows 'Yes' if the alarm is inactive and 'No' if the alarm is active. Always shows 'Yes' if the alarm is inhibited (below).
N.acknowledged	As for 'Active' above but shows 'Yes' for as long as the alarm is unacknowledged, and 'No' as soon as it is acknowledged. Always shows 'No' if the alarm is inhibited (below).
Acknowledgement	Fleetingly goes 'Yes' on alarm acknowledgement, and then returns to 'No'.
Inhibit	When 'Inhibit' is enabled, (tick symbol), the alarm is inhibited. Status is set to 'Off'; 'Active' and 'N.acknowledged' are set to 'No', and 'Inactive' is set to 'Yes'. If the alarm is active when inhibit is enabled, then it becomes inactive un-

uration. Similarly if the alarm trigger becomes active when the alarm is inhibited, the alarm remains 'off' until inhibit is disabled, when its status depends on its configuration.

Alarm 2 menu

As above for Alarm 1 menu.

Note: The parameters 'Acknowledge', 'Active', 'Inactive', 'N(ot) Acknowledged' and, 'Acknowledgement' can all be 'wired' to other parameters, so, for example, a relay can be made to operate whilst the alarm is inactive or whilst it is active or on acknowledgement etc. by wiring the relevant parameter to the relay's 'PV' input. See "User Wiring" for details of user wiring.

Alarm types

The following figures attempt to show graphically the meanings of the alarm parameters which can be set for the various alarm types available.

Absolute Alarms

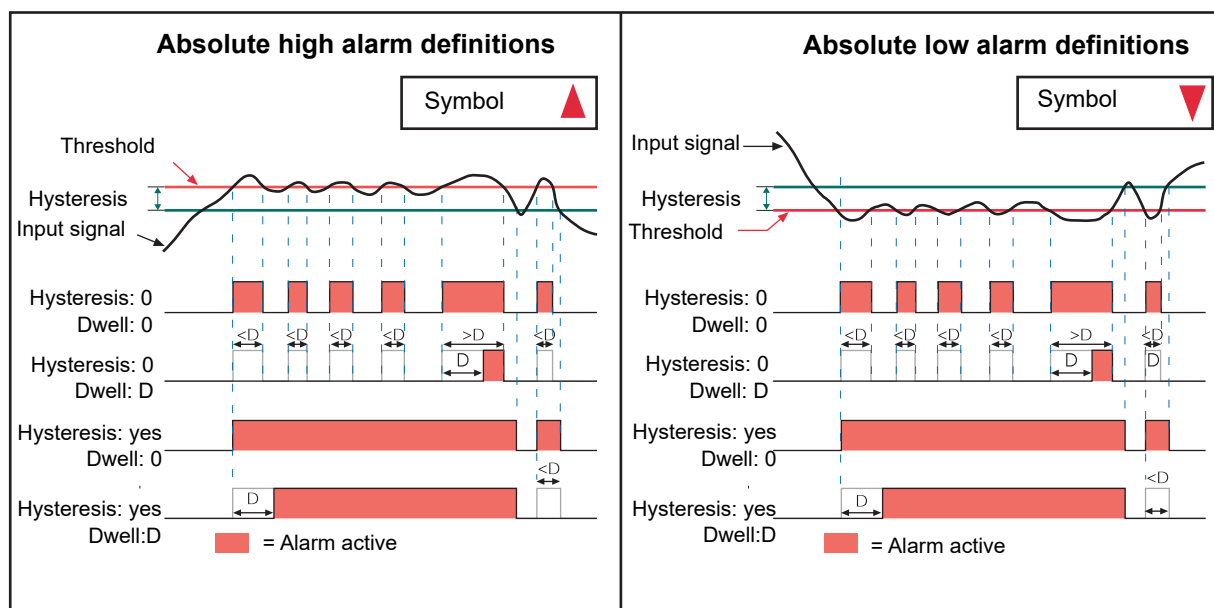

Figure 94 Absolute alarm parameters

Deviation Alarms

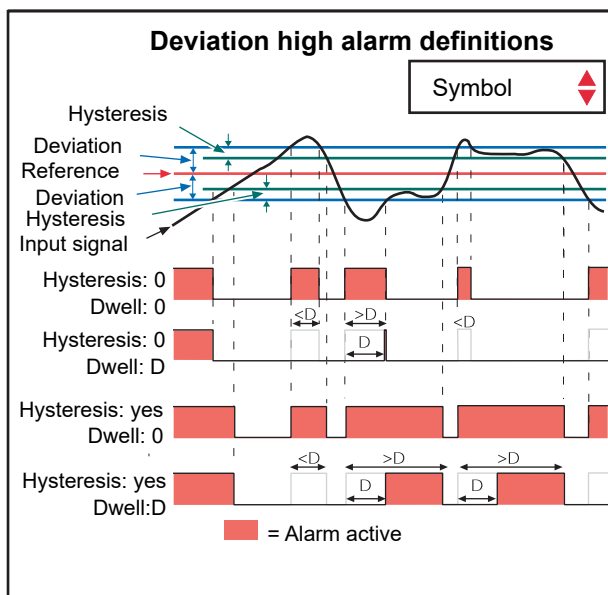
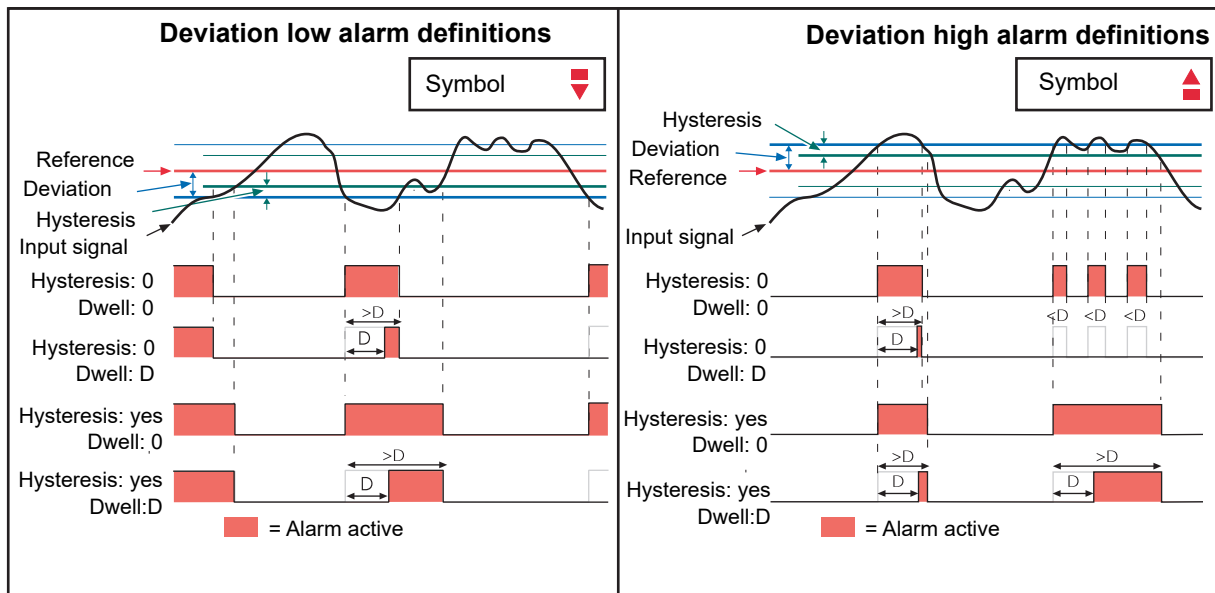

Figure 95 Deviation alarm parameters

Rate-Of-Change Alarms

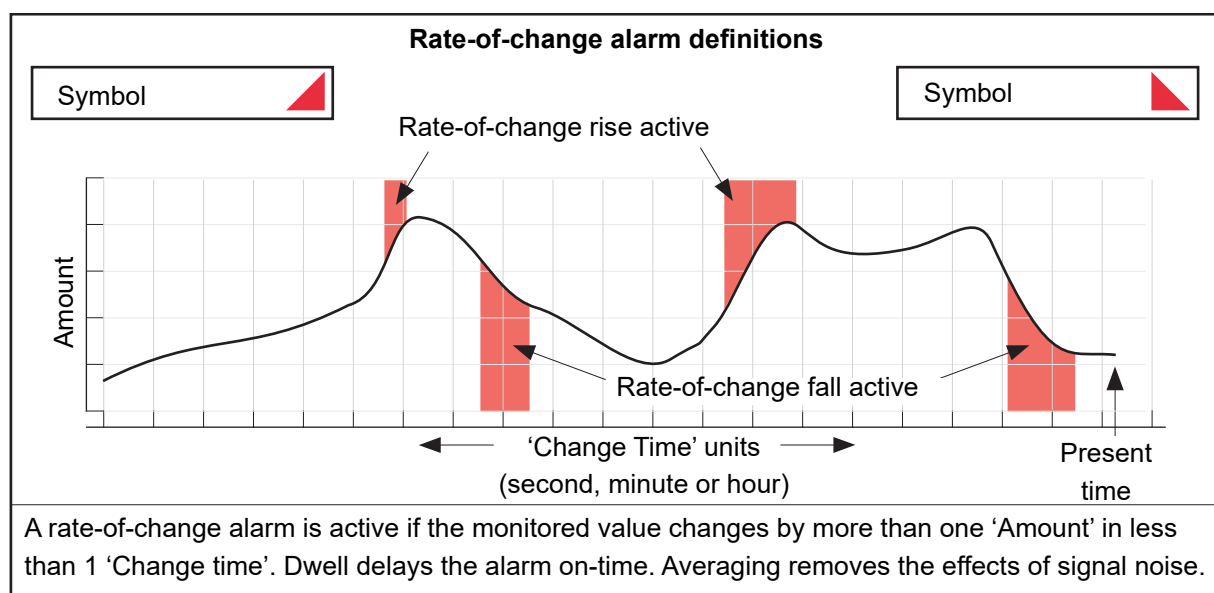

Figure 96 Rate-of-change alarm parameters

Note: Operation of rate-of-change alarms may be affected if an input filter ("Channel Main" on page 123) is applied to the input signal.

Virtual Channel Configuration

This allows the configuration of maths channels, totalisers and counters. The configuration is divided into the following areas: 'Main', 'Trend', 'Alarm 1*' and 'Alarm 2*'. Items appearing in the 'Trend', 'Alarm 1' and 'Alarm 2' areas are identical with the equivalent items described in "Input Channel Configuration" on page 123 (Input channels), above.

Note: * Virtual channels 16 to 30 (supplied with Modbus Master and EtherNet/IP options only) come without alarms

Maths channel configuration

The following maths functions are available (listed in up-arrow scroll order) Off, Add, Subtract, Multiply, Divide, Group Average, Group minimum, Group maximum, Modbus input, Copy, Group minimum (latch), Group maximum (latch), Channel maximum, Channel minimum, Channel Average, Configuration revision, Off.

Figure 97 shows a typical maths channel configuration.

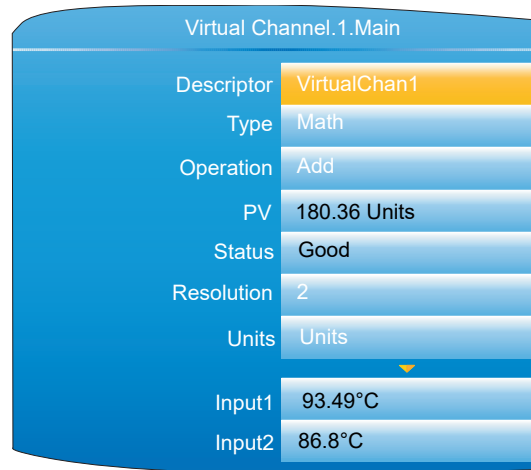

Figure 97 Maths channel configuration (typical)

Descriptor	Allows the user to enter a descriptor (20 characters max.) for the maths channel
Type	Math selected for this example. See "Totaliser configuration" on page 135 and "Counter configuration" on page 141 for totalisers and counters respectively.
Operation	Allows the user to select the required maths function. See 'Maths Functions', below.
PV	Read only. Shows the dynamic value of this channel in the units entered in 'Units' below.
Status	Read only. Shows the status of this channel, reflecting the status of the input sources.
Resolution	Enter the number of decimal places required
Units	Allows a five character string to be entered to be used as the channel units.
Input1	The value of input 1. May be entered manually, or it may be wired from another parameter ("ITOOLS"). Uses the resolution of the source.
Input 2	As for 'Input 1', Appears only when the operation requires two inputs.
Reset	Allows the user to reset latching functions (e.g. Channel Max) or averaging functions (e.g. Channel Avg). Reset is carried out by setting the field to 'Yes', then operating the scroll key. The display returns to 'No'. Alternatively the function can be reset by another parameter wired to 'Reset'.
Time Remaining	The period of time remaining before the virtual channel performs its operation. For example, the time remaining for the maths channel average operation to sample the input before performing the calculation.
Period	For averaging functions, this allows a period to be entered, over which the value is to be averaged. Selectable periods are: 0.125, 0.25, 0.5, 1, 2, 5, 10, 20, 30 seconds, 1, 2, 5, 10, 20, 30 minutes, 1, 2, 6, 12, 24 hours.

Maths Functions

Off	Out = -9999; status = Off
Add	Out = Input1 + Input2
Subtract	Out = Input1 - Input2
Multiply	Out = Input1 x Input2
Divide	Out = Input1 / Input2. If Input2 = 0, Out = -9999; Status =

Group Avg*	Out = Instantaneous sum of all points in the recording group (except this one and any channel that has been configured with operation = group average, group minimum, group maximum, group minimum (latched), group maximum (latched), channel maximum or channel minimum), divided by the number of points in the group (excluding this one). Any point that has a status other than 'Good' is excluded from the calculation. If the group contains no channels, Out = -9999; Status = 'No data'.
Group Min*	Out = Instantaneous value of whichever point (except this one) in the recording group has the lowest value. Any point that has a status other than 'Good' is excluded from the calculation. If the group contains no channels, Out = -9999; Status = 'No data'.
Group Max*	Out = Instantaneous value of whichever point (except this one) in the recording group has the highest value. Any point that has a status other than 'Good' is excluded from the calculation. If the group contains no channels, Out = -9999; Status = 'No data'.
Modbus Input	Out = value written to this channel's Modbus input. If the comms timeout expires, Out = -9999; status = 'No data'.
Copy	Allows an input or other derived channel to be copied.
Grp Min Latch*	Out = Lowest value reached by any point in the recording group (except this one) since last reset. Any point that has a status other than 'Good' is excluded from the calculation. If the group contains no channels, Out = -9999; Status = 'No data'.
Grp Max Latch*	Out = Highest value reached by any point in the recording group (except this one) since last reset. Any point that has a status other than 'Good' is excluded from the calculation. If the group contains no channels, Out = -9999; Status = 'No data'.
Channel Max	Out = Highest value reached by Input1 since last reset. If Input1 has a status other than 'Good', then Out = -9999 and 'Status' depends on the status of Input1.
Channel Min	Out = Lowest value reached by Input1 since last reset. If Input1 has a status other than 'Good', then Out = -9999 and 'Status' depends on the status of Input1.
Channel Avg	Out = the average value of Input1 over the time specified in 'Period'. If Input1 has a status other than 'Good', then Out = -9999 and 'Status' depends on the status of Input1.
Config Revision	Out = current Configuration Revision value.

Note: * All 'Group' functions operate on the 'Recording' group, not on the 'Trend' group.

Totaliser configuration

Totalisers allow the user to maintain a running total of any input channel, or of any maths channel. Using maths channels, it is possible to totalise combinations of input channels so that, for example, the sum of two channels or the difference between them could be totalised if required.

A totaliser is configured using Virtual Channels. This is in essence a way to convert an input signal representing a rate of change of some parameter, such as a fuel flow being measured, for example, in litres/minute into a cumulative flow. If the fuel flow is constant then, of course, the conversion would be simple, just multiply the flow rate by time and the answer comes out directly in litres. Provided, of course, that the time units of the flow rate and the time measurement are in the same units. Both need to be in Seconds, Minutes, Hours, etc. in order to get the correct answer.

If the flow rate is variable, the calculation has to be done repeatedly over the time period required and the results of the individual calculations must then be added together (Totalised). In order to get reasonable accuracy it is important that the flow should be reasonably constant during each measurement period. This means that the sampling time for the measurements should be sufficiently frequent that significant changes in flow rate are not missed. If the sampling frequency is high enough, the totalisation process is approximately equivalent to mathematical integration of the input signal.

The totaliser block in the nanodac is intended to automate this process. It uses the built-in sampling rate of the nanodac (125mSec) as the sampling period for the totalisation process. In addition, it provides two separate parameters which can be used to adjust the results of the totalisation process so that the output from the block is scaled in the correct units. [Figure 99](#) shows the Main configuration parameter list when the Virtual Channel block is being configured as a totaliser.

Wiring is carried out, either at the operator interface ("User Wiring"), or in iTools ("ITOOLS").

The totaliser equation is:

$$tot_t = tot_{t-1} + \frac{ma_t}{PSF \times USF}$$

where,

tot_t = totaliser value this sample

tot_{t-1} = totaliser value last sample

ma_t = process value this sample

PSF = Period Scaling Factor (Period)

USF = Units Scaling Factor (Units scaler)

Note: The time between samples is 125ms.

[Figure 99](#) shows a typical totaliser configuration page.

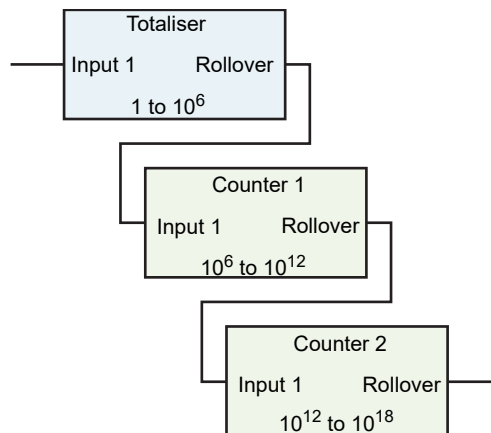
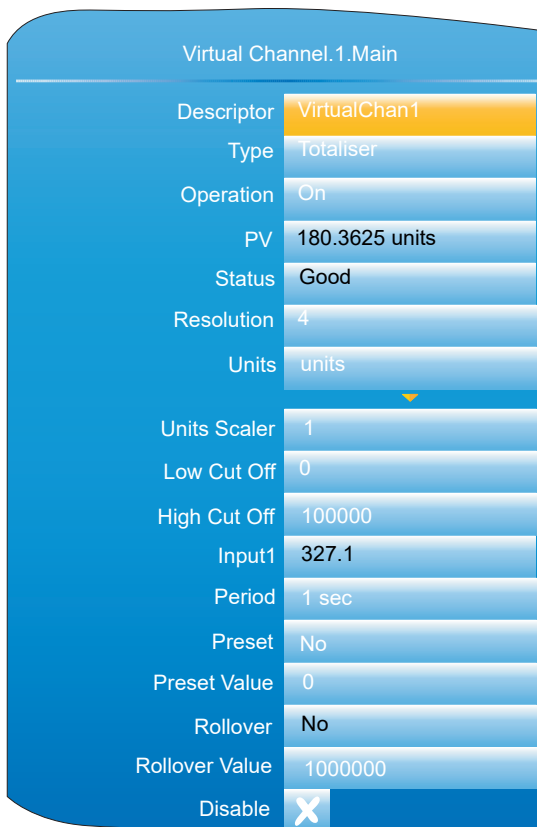

Figure 98 Using cascaded counters to expand the totalisation range.

Figure 99 Typical totaliser configuration menu

Descriptor	Allows the user to enter a descriptor (20 characters max.) for the totaliser.
Type	Select: Math, Counter or Totaliser.
Operation	Allows the user to enable ('On') or disable ('Off') the totaliser. PV Read only. This is the dynamic output value of the totaliser.
Status	Read only. Shows the status of the totaliser.
Resolution	The Resolution parameter allows the number of decimal places (up to six) to be set for the totalised value as displayed on the instrument panel. It does not affect the resolution of the totalisation process. Up to six decimal places may be set for the totalised value.
Units	Allows a units string of up to five characters to be entered for the totalised value.
Units Scaler	Allows a units scaler to be selected. Typically this will be used to scale between unit types rather than to influence time period. One example of this would be when an input is measured in Litres/Minute, and Period has been set to 1Minute. If UnitsScaler is set to 1 then the total volume will be measured in Litres. If the volume is required in Cubic Metres then conversion of the total will be needed. There are 1000 Litres in a Cubic Metre so the UnitsScaler should be set to 1000. This produces an additional division of 1000 and results in a total output in Cubic Metres. Another example would be a requirement for the output in Gallons rather than litres, still with an input being measured in Litres/Minute. There are 4.54609 litres in an imperial gal-lon so the UnitsScaler would be set to 4.54609. (For a US Gallon the figure would be 3.78541.)

Low Cut Off	Used to restrict the input operating range of the totaliser. Minimum value = -100 000
High Cut Off	Used to restrict the input operating range of the totaliser. Maximum value = 100 000 <p>Low Cut Off and High Cut Off are particularly important as they directly affect the totalisation process. Together these two parameters define the range of valid inputs to the totalisation process. If Input1 value lies between them, then the input is considered valid and it contributes to the total for any period during which it remains valid. Negative input values are allowed and will cause the totaliser to decrease in value for negative values.</p> <p>The total increases with positive values.</p> <p>If the input lies outside the region defined by these CutOff parameters then it will be ignored and not contribute to the total. Many applications do not wish to use negative values and so LowCutOff would then normally be set to 0. Occasionally though, calibration errors at the low scale end could cause unacceptable errors in the total. In these circumstances, it may be necessary to consider setting Low-CutOff to a small positive value.</p> <p>An example where this may be needed is when a process has a very low input value for long periods of time interspersed with short periods of high input values. The cumulative effect of slightly inaccurate low input values for long periods could then reduce the accuracy of the overall total recorded.</p> <p>Thoughtful use may produce an increase in the overall accuracy of the total; inappropriate use could introduce significant inaccuracy.</p>
Input1	The value of the source. May be entered manually, or this parameter can be wired from an external channel PV. Input1 is the input signal representing an external measurement which is in the form of Units/Time-Unit, i.e. a rate. The sampling rate internal to the block is fixed at the instrument tick rate of eight times/second, taking one sample every 125ms.
Period	The Period parameter divides the signal being applied to Input1 by the number which is needed to generate a Total PV which is scaled in appropriate time units. There is a selection of preset values available for the Period parameter. These are listed in Table 1 below. The totaliser equation works in seconds. If the totalised channel units are other than 'per second', a period scaler different from the default (1 sec) must be used. The 'Period' field presents a number of fixed periods from 0.125 seconds to 24 hours for selection.
Preset	Setting this to 'Yes' causes the totaliser to adopt the Preset Value. The field returns immediately to 'No'. The totaliser can also be pre set by an external source 'wired' to this parameter.
Preset Value	Allows the entry of a value, from which the totaliser is to start incrementing or decrementing. The direction of the count is set by the sign of the units scaler: positive = increment; negative = decrement.
Rollover	This is the rollover output which will be set for one execution cycle when the totaliser rolls over. This output can be used to expand the range of the totaliser by wiring it to the Trigger input of a counter.
Rollover Value	This is the value at which the totaliser will roll over to 0. It is configurable (default 1 000 000). When the totaliser rolls

culated output will be added to 0.

Example 1: with a rollover value of 1000, a current output of 999 and an input of 5, then the output will become 4.

Example 2: with a rollover value of -1000, a current output of -999 and an input of -5, then the output will become -4. In both examples, the Rollover output will be set for 1 execution cycle.

Many applications do not require very large values to be totalised and can be scaled so that the Rollover Value will never be reached. The instrument default value of 10^6 is generally satisfactory for these. If, however, higher values are expected, a larger Rollover value than this will have to be used. When configuring very large values the number stored on the instrument display may be slightly larger or slightly smaller. This happens because the numbers are stored in the instrument in IEEE representation as used by all computing systems to save space. The trade-off is that very large values are stored with a small inaccuracy, which increases as the value being stored increases. As an example, if a value of 9,999,999,999,999 is entered into the instrument screen as the Rollover value, it is read back on the instrument panel as 9,999,999,827,968. The inaccuracy caused by the compression amounts to 0.02 parts per million, considerably smaller than the inaccuracy associated with the input channel which is being used to generate the input to the totaliser.

Disable

Allows the user temporarily to suspend totalising action. The totaliser is toggled between being enabled (cross symbol) and disabled (tick symbol) by means of the scroll key. The output retains the pre-disabled value until the totaliser is re-enabled, when it resumes from that value, or until the value is changed using the Preset parameter mentioned above. In the latter event, it will still be necessary to enable the totalisation by setting the Disable parameter to the cross symbol again.

Table 1: Period

Sec	Divider	Sec	Divider	Min	Divider	Hour	Divider
0.125	1	1	8	1	480	1	2880
0.25	2	2	16	2	960	2	5760
0.5	4	5	40	5	2400	6	17280
		10	80	10	480	12	34560
		20	160	20	960	24	69120
		30	240	30	1440		

The selections in Bold Italic font are those which set the calculation into common time units, Second, Minute, Hour and Day (24Hours), and are probably going to be the most commonly selected. The other selections may be useful for more unusual applications.

Note: The formula linking Input1 and PV is:

$PV \text{ Increment each } 0.125\text{Sec} = \text{Input1}/(8 * \text{Period}(\text{Sec})) * \text{UnitsScaler}$.

There is no reason why the Period and UnitsScaler parameters have to be used only in the way described above, one reflecting the units used by the input channel and the other linked directly to the output units required. There may be application where they may be used in other ways. Use Table 1, which shows the divisor associated with a particular selection for Period, in combination with a custom value as the UnitsScaler to generate a custom overall divisor.

Wiring Example using a counter in combination with a totaliser

Figure 100 shows how a counter and totaliser can be linked in a real application using the internal (soft) wiring in iTools. See also "Graphical Wiring Editor" on page 354.

The application is to provide a running total of power being used by a process.

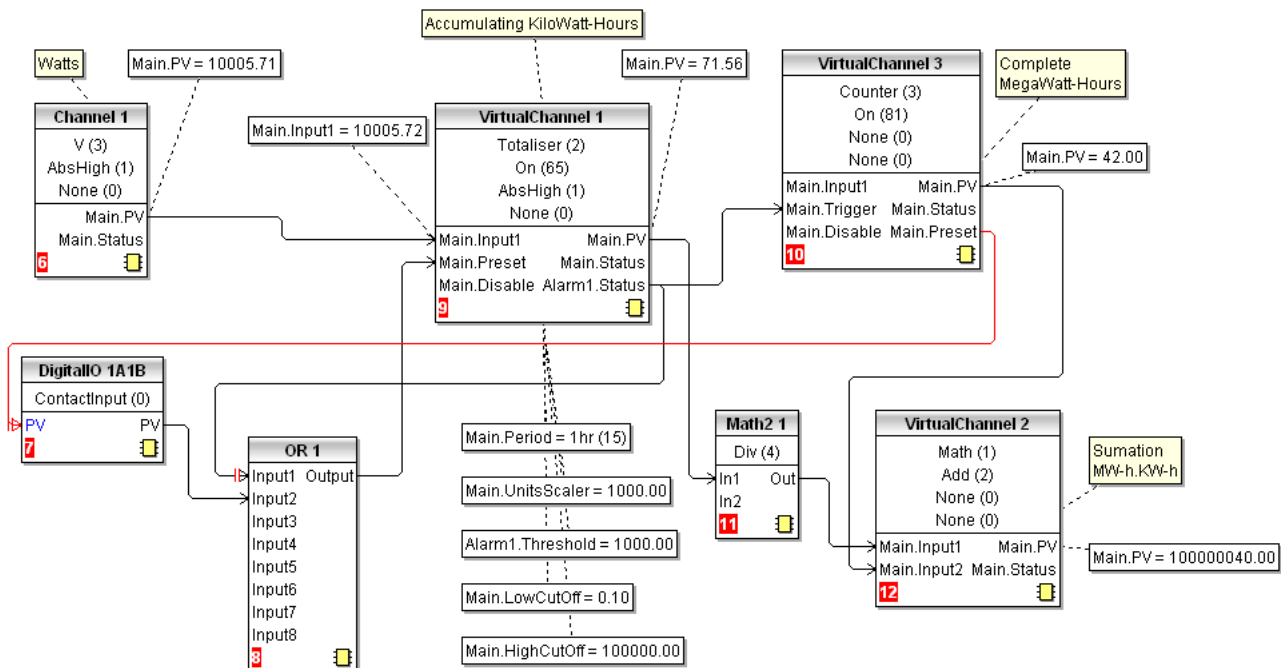

Figure 100 Linking a counter and totaliser

In this example

Channel 1 input is connected to a wattmeter.

Totaliser VC1 uses the period parameter to set the timescale of the units to hours. The UnitsScaler is set to 1000 to set the units of the total to Kilowatt-Hours.

Alarm 1 in VC1 is set as Absolute High and the Alarm Status output resets VC1 and increments the counter VC3 by 1.

Math2 1 takes the output from VC1 and converts it into MegaWatt-Hours so that it can be added to the count (also in MegaWatt-Hours) from VC2 to present a running total value.

Digital Input 1A1B is used to simultaneously reset both the count in VC2 and the total in VC1.

OR 1 is used to allow VC1 to be reset either by 1A1B or by the total reaching 1000.

Note: Firmware version 5.00 uses 64 bit IEEE calculations. Inputs and outputs from the block as wiring to and from other blocks is still in 32bit format, just like all other instrument parameters. Inside the totaliser block these are converted to 64bits and processed in the 64bit domain until their value has to be used by another block or has to be sent over comms, when it is converted back to 32bits.

Counter configuration

This allows the user to set up a counter to count trigger inputs (or it may be incremented from the Configuration page. The Rollover Value of the counter is configurable (default 1,000,000). Counters can be cascaded by wiring from 'Rollover' of one counter to 'trigger' of the next. Wiring is carried out from the operator interface ("User Wiring") or in iTools ("iTOOLS").

For 'Trend', 'Alarm 1' and 'Alarm 2' configurations please see the relevant parts of "Input Channel Configuration" on page 123.

Virtual Channel 1.Main	
Descriptor	VirtualChan1
Type	Counter
Operation	On
PV	123436 units
Status	Good
Resolution	0
Units	units
Low Cut Off	0
High Cut Off	999999
Input1	015.3241
Preset	0
Preset Value	0
Trigger	No
Rollover	No
Rollover Value	1000000
Disable	X

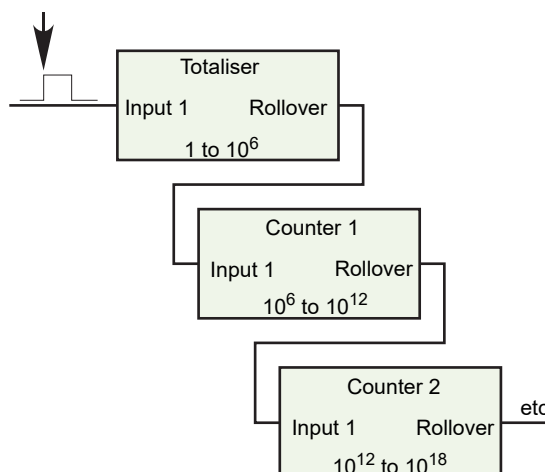

Figure 101 Cascading counters

Figure 102 Typical Counter configuration

Descriptor	Allows the user to enter a descriptor (20 characters max.) for the counter.
Type	Select: Math, Counter or Totaliser.
Operation	Allows the user to enable ('On') or disable ('Off') the counter.
PV	Read only. Shows the dynamic value of the counter.
Status	Read only. Reflects the status of the input channel.
Resolution	Allows the number of decimal places (up to six) to be defined for the channel.
Units	Allows a units string of up to five characters to be entered for the counter value.
Low Cut Off	Specifies a value below which the counter will not decrement.
High Cut Off	Specifies a value above which the counter will not increment.

Input1	The amount by which the counter is incremented each time 'Trigger' goes high. The value may be entered manually, or wired from another parameter. Negative values cause the counter to decrement.
Preset	Setting this to 'Yes' causes the counter to adopt its Preset Value. The field returns immediately to 'No'. The counter can also be preset by wiring from another parameter.
Preset Val	Allows the entry of a value, from which the counter is to start incrementing or decrementing.
Trigger	Setting this to 1, causes the current value of the input source to be added to the Counter value. This function can be carried out manually, or the input can be wired from another parameter (Section 10.2).
Rollover	This is the rollover output which will be set for one execution cycle when the counter rolls over. This output can be used to expand the range of the cascade counters by wiring it to the Trigger input of the next counter.

Rollover Value This is the value at which the counter will rollover and is configurable in the same way as the totaliser. When the counter rolls over the difference between the rollover value and the calculated output will be added to 0.

Example 1: with a rollover value of 1000 and a current output of 999 and an input of 5, then the output will become 4 when the counter is next triggered.

Example 2: with a rollover value of -1000 and a current output of -999 and an input of -5, then the output will become -4 when the counter is next triggered.

Note: In both examples, the Rollover output will be set for one execution cycle.

Disable	Allows the user temporarily to suspend counting. The output retains the pre-disabled value until the counter is re-enabled, when it resumes counting from that value. The counter is toggled between being enabled (cross symbol) and disabled (tick symbol) by means of the scroll key.
---------	--

Loop Option Configuration

This configuration area allows the user to set up two control loops. This description refers to temperature control loops, but the configuration parameters apply equally to other types of control. For each loop, channel 1 is assumed to be a heating channel; channel 2 a cooling channel.

The configuration is divided into a number of areas, as shown in the overview below.

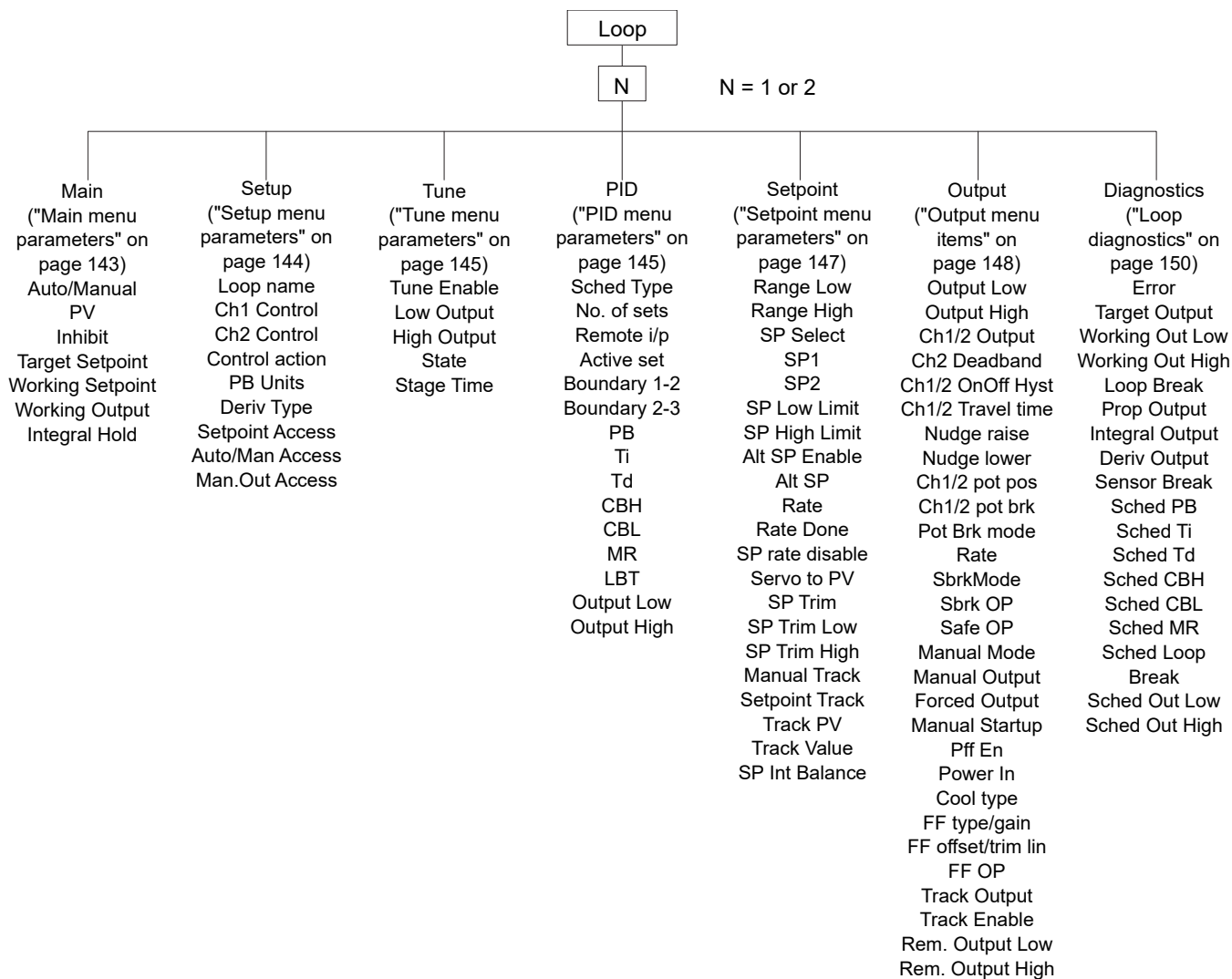

Figure 103 Loop configuration overview

For a general discussion of control loops, please see "Appendix B: Control Loops".

Main menu parameters

Auto/Manual	Selects Auto(matic) or Manual operation. 'Auto' automatically controls output power in a closed loop configuration. In manual mode, the operator controls the output power.
PV	The Process Variable input value. The value can be entered by the user, but is most often 'wired' from an analogue input.
Inhibit	Select 'No' or 'Yes'. 'Yes' stops the loop and sets the output to a 'safe' value, this value being entered as a part of the Output configuration ("Output menu items" on page 148). If an output rate limit is set, then the output ramps to the safe level at that rate, otherwise it performs a step change. If setpoint or manual tracking is enabled (in setpoint configuration "Setpoint menu parameters" on page 147), Inhibit overrides tracking. If 'No' is selected, the loop operates normally. Inhibit can be enabled/disabled from an external source.
Target Setpoint	The value at which the control loop is aiming. SP may be derived from a number of sources, as described in Section B2.5. The value range limited by the setpoint limits (SP

	High Limit and SP Low Limit) described in "Setpoint menu parameters" on page 147.
Working Setpoint	A read-only value displaying the current value of setpoint being used by the loop. This might or might not be the Target setpoint. The value may come from a number of sources, but is limited by the setpoint limits (SP High Lim and SP Low Lim) described in "Setpoint menu parameters" on page 147.
Working Output	The actual working output value before being split into channel 1 and 2 outputs.
Integral Hold	Select 'Yes' or 'No'. 'Yes' freezes the integral term at its current value. IntHold ensures that the power is reapplied smoothly after the loop has been broken for service reasons, for example.

Setup menu parameters

Loop Name	Allows entry of an 11 character name for the loop.
Ch1 Control	Selects the type of control for channel one from: Off: Channel is turned off. OnOff: Channel uses on/off control. PID: Proportional + integral + derivative (three-term) control. VPU: Valve positioning unbounded. VPB: Valve positioning bounded. Section B2.2 provides more details.
Ch2 Control	As above, but for loop channel two.
Control Action	Select 'Reverse' or 'Direct'. 'Reverse' means that the output is 'on' when the process value (PV) is below the target setpoint (SP). This is normal for heating control. 'Direct' means that the output is on when PV is above SP. This is normal for cooling control.
PB Units *	Select 'Engineering' or 'Percent'. 'Engineering' displays values in (for example) temperature units ¹ (e.g. °C or °F). 'Percent' displays values as a percentage of loop span (Range Hi - Range Lo).
Deriv Type *	'Error' means that changes to PV or SP cause changes to the derivative output. Derivative on error should be used with a programmer since it tends to reduce ramp overshoot. 'Error' provides rapid response to small setpoint changes which makes it ideal for temperature control systems. 'PV' means that changes in PV alone cause changes to the derivative output. Typically used for process systems using valve control, as it reduces wear on the valve mechanics.
Setpoint Access	Allows setpoint editing permission in the loop display pages ("Control Loop1/Loop2" on page 57). 'Read/Write' allows free access to all users. 'Read Only' allows editing only in Configuration or Supervisor modes. 'Operator R/W' allows editing in all modes except 'Logged out'.
Auto/Man Access	As 'Setpoint Access' above, but for Auto/manual parameter.

¹ Temperature units are those configured for the channel to which the tem

Man.Out Access As 'Setpoint Access' above, but configures the read/write access for the Manual Output parameter.

Note: * 'PB Units' and 'Deriv Type' appear only if at least one of Ch1 Control and Ch2 Control is set to 'PID', 'VPU' or 'VPB'.

Tune menu parameters

Tune R2G Defines the type of relative cooling gain tuning for the loop. 'Standard' -tunes the relative cooling gain of the loop using the standard R2G tuning algorithm. 'R2GPD' - If the process is heavily lagged, this setting should be used. 'Off' - R2G is not calculated automatically. Enter the value manually as described in "Manual tuning" on page 419.

Note: This parameter only appears when both channel 1 and channel 2 are configured (for example, in heat/cool processes).

For further information, refer to "Autotune" on page 411.

Tune Enable 'On' initiates autotune. Legend changes to 'Off' when autotune is complete. Can be set to 'Off' manually, to stop the tuning process.

Low Output Sets a low limit to be imposed whilst autotune is running. The value must be greater than or equal to the 'Output Low' value, specified in the Output menu ("Output menu items" on page 148).

High Output Sets a high limit to be imposed whilst autotune is running. The value must be less than or equal to the 'Output High' value, specified in the Output menu ("Output menu items" on page 148).

State Read only display of autotune progress:
Off. Autotune not running.
Ready. Fleeting display. Changes immediately to 'Running'.
Running. Autotune is in progress.
Complete. Autotune completed successfully. This is a fleeting display which changes immediately to 'Off'.
Timeout, TI Limit and R2G Limit are error conditions described in "Autotune" on page 411. If any of these occurs, tuning is aborted and the PID settings remain unchanged.

Stage A read only display showing the progress of the autotune:
Settling. Displayed during the first minute whilst loop stability is checked ("Autotune" on page 411)
To SP. Heating or cooling switched on.
Wait min. Power output off.
Wait max. Power output on.
Timeout, TI Limit and R2G Limit are error conditions described in "Autotune" on page 411.

Stage Time Time into the current stage of the autotune process. 0 to 99999 seconds.

AT.R2G Autotune at R2G. 'Yes' means that the control loop uses the R2G value calculated by autotune. 'No' causes the loop to use the R2G value entered by the user (PID menu) calculated as described in "Autotune" on page 411.

PID menu parameters

Note: If control type is set to 'Off', or 'OnOff' in the Setup menu, the PID menu contains only the Loop Break Time parameter 'LBT'.

Sched Type	Selects the type of gain scheduling ("Gain Scheduling" on page 407) to be applied. Off. Gain scheduling not active Set. The user selects the PID parameter set to be used. Setpoint. Transfer from one set to the next depends on the setpoint value. PV. The transfer from one set to another depends on the PV value. Error. The transfer between sets depends on the value of the error signal. OP. Transfer depends on the value of the output. Rem. Transfer is controlled by a remote input.
Number of Sets	Allows the number of sets of PID parameters for use in Gain scheduling to be selected.
Remote input	For 'Sched Type' = 'Rem' only, this shows the current value of the remote input channel being used to select which set is active. If the remote input value = the Boundary 1-2 value (see below) then set 1 is selected. If it is > Boundary 1-2 value but = Boundary 2-3 value then set 2 is used. If the remote value is > Boundary 2-3 value, then set three is used. If the Remote input is not 'wired', the value is user editable from the front panel.
Active Set	The set number currently in use.
Boundary 1-2	For all Sched Types except 'Set', this allows the user to enter a 'boundary' value, which means that if the relevant value (SP, PV, Error etc.) rises above this boundary, the loop switches from PID set 1 to PID set 2. If it falls below the boundary value, the loop switches from set 2 to set 1.
Boundary 2-3	As above but for switching between sets 2 and 3.
PB/PB2/PB3	Proportional band for set one/two/three. The proportional term in the units (Engineering units or %) set in 'PBUnits' in the Setup menu. See "PID Control" on page 401 for more details.
Ti/Ti2/Ti3	Integral time constant for set one/two/three. Valid entries are 1 to 9999.9 seconds, or 'Off'. If set Off, then integral action is disabled. Removes steady state control offsets by moving the output up or down at a rate proportional to the error signal.
Td/Td2/Td3	Derivative time constant for set one/two/three. Valid entries are 1 to 9999.9 seconds, or 'Off'. If set Off, then derivative action is disabled. Determines how strongly the controller reacts to a change in the PV. Used to control overshoot and undershoot and to restore the PV rapidly if there is a sudden change in demand.
R2G/R2G2/R2G3	Relative cool gain for set one/two/three. Appears only if cooling has been configured (Ch2 Control not 'Off' or 'On-Off' in Setup menu). Valid entries are 0.1 to 10. Sets the cooling proportional band which compensates for differences between heating and cooling power gains.
CBH/CBH2/CBH3	Cutback high for set one/two/three. Valid entries 'Auto' (3'PB) or 0.1 to 9999.9. The number of display units above setpoint at which the controller output is forced to 0% or -100% (OP min), in order to modify undershoot on cool down. See "High and Low cutback" on page 405 for more details.
CBL/CBL2/CBL3	Cutback low for set one/two/three. Valid entries 'Auto' (3'PB) or 0.1 to 9999.9. The number of display units below setpoint at which the controller output is forced to 100% (OP max), in order to modify overshoot on heat up. See "High and Low cutback" on page 405 for more details.

MR/MR2/MR3	Manual reset for set one/two/three. Valid entries 0 to 100%. Introduces a fixed additional power level to the output in order to eliminate steady state error from proportional only control. Applied instead of the integral component when Ti is set to 'Off'.
LBT/LBT2/LBT3	Loop break time for set one/two/three. valid entries are 1 to 99999 seconds, or 'Off'. See "Loop Break" on page 406 for more details.
Output Low/2/3	Output low limit for set one/two/three. Valid entries are in the range Output High/2/3 to - 100.
Output High/2/3	Output high limit for set one/two/three. Valid entries are in the range Output Low/2/3 to +100.

Setpoint menu parameters

Range High/Low	Range limits. Valid entries from 99999 to -99999. Range limits set absolute maxima and minima for control loop setpoints. If the proportional band is configured as a percentage span, the span is derived from the range limits.
SP select	Select SP1 or SP2. SP1 is considered to be the primary setpoint for the controller, and SP2 a secondary (standby) setpoint.
SP1, SP2	Allows values for Setpoints 1 and 2 to be entered. Valid entries are any within the range 'SPHigh Limit' to 'SPLow-Lim'.
SP Low Limit	Minimum setpoint limit for SP1 and SP2. Valid entries are in the range 'Range Lo' and 'SP High Limit'.
SP High Limit	Maximum setpoint limit for SP1 and SP2. Valid entries are in the range 'Range Hi' and 'SP Low Limit'.
Alt SP Enable	'Yes' enables the alternative setpoint; 'No' disables it. May be wired to an external or in-ternal source.
Alt SP	When wired this is a read only display of the alternative setpoint value. Otherwise, the user may insert a value. Valid values are limited by 'Range Hi' and 'Range Lo'.
Rate	Sets the maximum rate at which the working setpoint may change in Engineering units per minute. Often used to protect the load from thermal shock cause by large step changes in setpoint. 'Off' disables rate limiting.
Rate Done	Read only display. 'Yes' indicates that the working setpoint has completed its change. 'No' indicates that the setpoint is still ramping.
SP Rate Disable	Appears only if Rate is not 'Off'. 'Yes' disables rate limiting; 'No' enables rate limiting.
Servo To PV	If 'Rate' is set to any value other than 'Off', and if 'Servo to PV' is set to 'Yes' then any change in the current setpoint value causes the working setpoint to servo to the current PV before ramping to the new setpoint value.
SP Trim	A positive or negative value added to the setpoint, for local fine tuning. Valid entries are any value between 'SP Trim High' and 'SP Trim Low'.
SP Trim High/Low	Setpoint trim high and low limits.
Manual Track	'On' enables manual tracking to allow the local SP to follow the value of the current PV. See "Manual Tracking" on page 423 for more details. 'Off' disables manual tracking.
Setpoint Track	'On' enables setpoint tracking to allow the local SP to follow the value of the alternative SP. See "Setpoint Tracking" on page 423 for more details. 'Off' disables setpoint tracking.

Track Value	The SP to track in manual tracking.
SP Int Balance	Allows the user to enable (tick) or disable (cross) debump on PV change.

Output menu items

"Output" on page 423 contains details of the output functions.

Output Low	The minimum power, or the maximum 'negative' (i.e. cooling) power to be delivered by the system. The valid input range is -100% and Output High.
Output High	The maximum output power to be delivered by channels 1 and 2, where 100% is full power. The valid input range is Output Low to 100.0%. Reducing this value reduces the rate of change of the process, but it also reduces the controller's ability to react to perturbations.
Ch1 Output	Displays the positive power values used by the heat output. Values range from Output low to Output high.
Ch2 Output	Displays the cooling power values for channel two. Appears as a value between Output high and -100%, where -100% represents full cooling power.
Ch2 Deadband	A gap (in percent) between output 1 switching off, and output 2 switching on, and vice-versa. Valid inputs are 0 (off) to 100%.
Rate	Limit on the rate at which the output from the PID can change. Can be useful in preventing rapid changes in output that could damage the process, heater elements etc.
Ch1 OnOff Hyst	Appears only if 'Ch1 Control' has been set to 'OnOff' in the Setup menu. Allows the user to enter a hysteresis value for channel one. Valid entries are 0.0 to 200.0.
Ch2 OnOff Hyst	Appears only if 'Ch2 Control' has been set to 'OnOff' in the Setup menu. Allows the user to enter a hysteresis value for channel two. Valid entries are 0.0 to 200.0.
Ch1 Travel Time	Appears only if Setup menu parameter 'Ch1 Control' is set to 'VPB' or 'VPU'. This is the valve travel time from closed (0%) to open (100%). In a valve positioning application, channel 1 output is connected by a single software 'wire' to a Valve Raise/Valve Lower relay pair. For heat/cool applications, channel 1 is associated with the heating valve. Valid entries: 0.0 to 1000.0 seconds.
Ch2 Travel Time	Appears only if Setup menu parameter 'Ch2 Control' is set to 'VPB' or 'VPU'. This is the valve travel time from closed (0%) to open (100%). For heat/cool applications, channel 2 is associated with the cooling valve. Valid entries: 0.0 to 1000.0 seconds.
Nudge Raise	Appears only if Setup menu parameter 'Ch1 Control' or Ch2 Control is set to 'VPU'. If set to 'Yes', the valve can be moved towards the open position by, for example, a contact closure, an up arrow button operation or a serial communications command. The default minimum nudge time is 125 ms, but this can be edited in the relevant relay configuration - see "Configuration Display" on page 193. See also "Valve nudge" on page 429 for more 'Nudge' details.
Nudge Lower	As for 'Nudge Raise', above but moves the valve towards the closed position.
Ch1 Pot Pos*	The position of the channel one actuator as measured by the feedback potentiometer.
Ch1 Pot Brk*	'On' indicates that the input to the relevant channel is open circuit.

Ch2 Pot Pos*	The position of the channel two actuator as measured by the feedback potentiometer.
Ch2 Pot Brk*	'On' indicates that the input to the relevant channel is open circuit.
Pot Brk Mode*	Defines the action to be taken if a potentiometer break is detected: Raise: opens the valve. Lower: closes the valve. Rest: the valve remains in its current state. Model: the controller tracks the position of the valve and sets up a model of the system so that it continues to function if the potentiometer becomes faulty.

Note: * These parameters appear only if the 'Setup' menu parameter 'Ch1 Control' or 'Ch2 control' (as appropriate) is set to 'VBP'. The Setup menu is described in "Setup menu parameters" on page 144.

SBrk Mode	Defines the action to be taken in the event of a sensor break. Safe: The output adopts the value configured in 'Sbrk OP', below. Hold: The output remains at its current level.
Sbrk OP	The value to be output if a sensor break occurs, and SBrk Mode (above) is set to 'Safe'.
Safe OP	The output level adopted when the loop is inhibited (Main menu "Main menu parameters" on page 143).
Manual Mode	Selects the type of transition to occur when changing to manual mode ("Main menu parameters" on page 143): Track: Whilst in Auto mode, the manual output tracks the control output so that there is no change of output when manual mode is switched to. Step: On transition to manual mode, the output is set to the value entered for 'Forced-OP' (below). Last Man. Out: On transition to manual mode, the output adopts the manual output value as last set by the operator.
Manual Output	The output when the loop is in manual mode. In manual mode the controller limits the maximum power, but it is not recommended that it be left unattended at high power settings. It is important that over range alarms are fitted to protect the process.

Note: It is recommended that all processes are fitted with an independent over range detection system.

Forced Output	Forced Manual output value. When 'Manual Mode' = 'Step', this is the output value adopted when changing from Auto to Manual mode.
Manual Startup	When set to off (cross symbol), the controller powers up in the same (auto or manual) mode that obtained when it was switched off. When set to on (tick symbol) the controller always powers up in manual mode.
Pff En	Power feed forward enable. 'Yes' enables power feed forward (adjusts the output signal to compensate for variations in supply voltage. 'No' disables Pff. See "Power Feed Forward" on page 426 for further details.
Power In	Read only display of the current supply voltage.
Cool Type	Appears only if 'Ch2 Control' = 'PID' in the setup menu ("Setup menu parameters" on page 144) and allows the user to enter the appropriate type of cooling ("Cool Type" on page 426): Linear: For use when controller output changes linearly with PID demand.

	Water: For water cooled applications Fan: For forced air cooling.
FF Type	Feed forward type ("Feed forward" on page 427): None: No signal fed forward. Remote: A remote signal fed forward. SP: Setpoint is fed forward. PV: PV is fed forward.
FF Gain	For FF types 'PV' and 'SP', this scales the feed forward signal.
FF Offset	For FF types 'PV' and 'SP', this defines the offset of the scaled feed forward signal.
FF Trim lim	For FF types 'PV' and 'SP', defines symmetrical limits about the PID output which are applied to the scaled feed forward signal.
FF OP	For FF types 'PV' and 'SP', this is the calculated (scaled, offset and trimmed) feed forward signal. FF OP = FF gain (input + FF Offset).
Track Output	If 'Track Enable' (below) is set to 'Yes', this is the value for the control output. PID remains in Auto mode and tracks the output. The Track OP value can be wired to an external source, or can be entered via the front panel. Similar to entering manual mode.
Track Enable	When set to 'Yes', the output follows the Track OP value (above). When subsequently set to 'Off' the loop makes a bump less return to control.
Rem. Output Low/High	Used to limit the output using a remote source. These limits cannot exceed the 'Output Low' and 'Output High' values described earlier in this section.

Loop diagnostics

These parameters are read only unless otherwise stated.

Error	The difference in value between the setpoint and the PV.
Target Output	The requested control output. The target of the active output if rate limiting is active.
Working Out Low	The low limit for the working output. This is the value used to limit the output power of the loop and is derived from the gain scheduled limit, the remote limit and the safety limit.
Working Out High	The high limit for the working output. This is the value used to limit the output power of the loop and is derived from the gain scheduled limit, the remote limit and the safety limit.
Loop Break	Loop Break Alarm. Becomes active 'Yes' if the loop break time (LBT), set in the PID menu ("PID menu parameters" on page 145) is exceeded, otherwise 'No' is displayed.
Prop. Output	Shows the proportional term contribution to the control output.
Integral Output	Shows the integral term contribution to the control output.
Deriv. Output	Shows the derivative term contribution to the control output.
Sensor Break	Indicates sensor break status. On (tick symbol) indicates a sensor break has occurred; Off (cross symbol) shows that no sensor breaks have been detected.
Sched PB	The scheduled proportional band for the current PID set.
Sched Ti	The scheduled integral time for the current PID set.
Sched Td	The scheduled derivative time for the current PID set.
Sched R2G	The scheduled relative cool gain value for the current PID

Sched CBH	The scheduled cutback high value for the current PID set.
Sched CBL	The scheduled cutback low value for the current PID set.
Sched MR	The scheduled manual reset value for the current PID set.
Sched Loop Break	The scheduled loop break time for the current PID set.
Sched Out Low	The scheduled output low limit for the current PID set.
Sched Out High	The scheduled output high limit for the current PID set.

Advanced Loop Configuration

Similar to the Loop option described above, advanced loop includes the ability to run a cascade loop.

Figure 4.7 is an overview of the configuration menu structure.

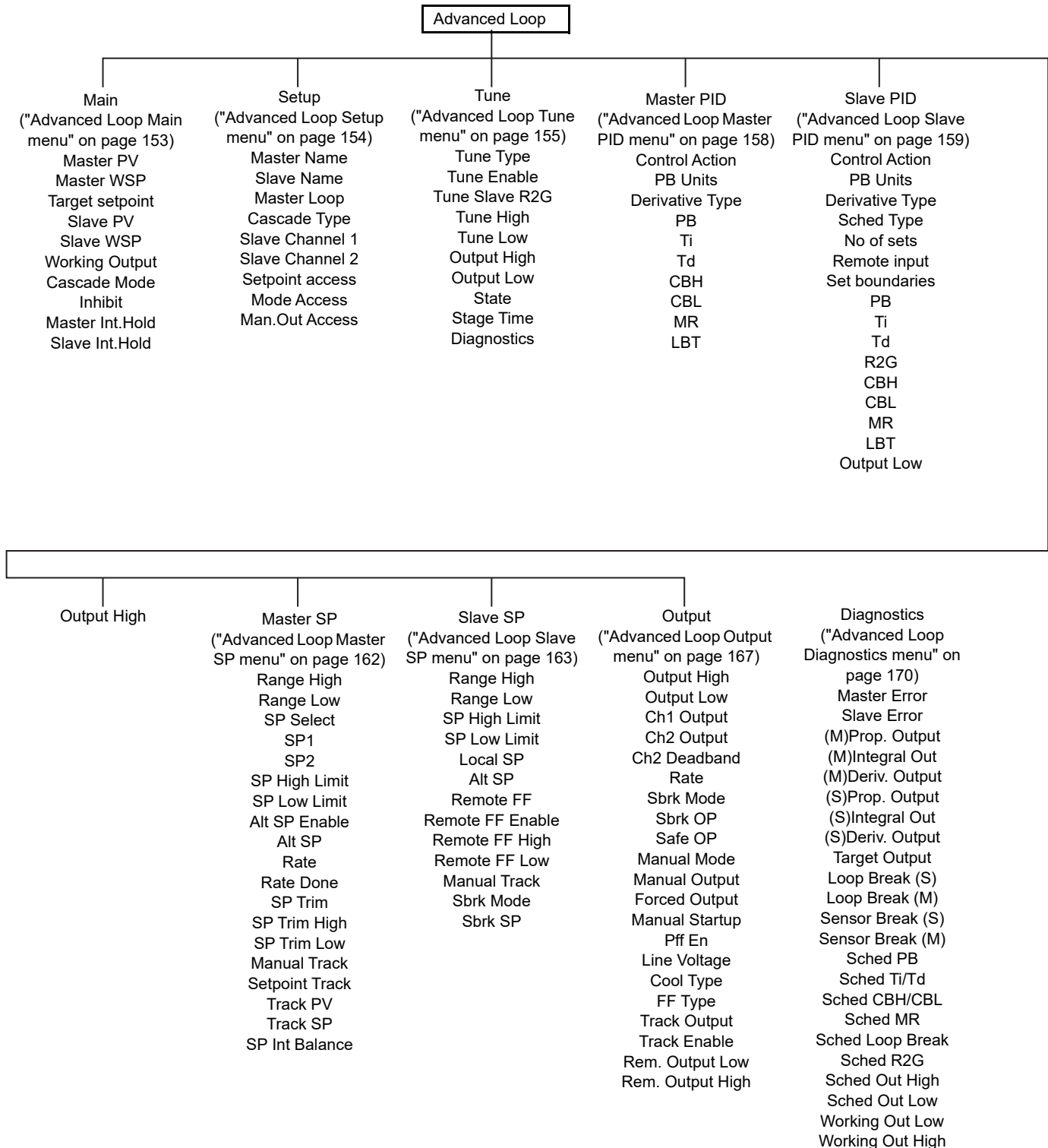

Advanced Loop Main menu

Advanced Loop.Main	
Master PV	0.0
Master WSP	16.1
Target setpoint	16.1
Slave PV	0.0
Slave WSP	32.2
Working Output	0.0%
Cascade Mode	Slave
Inhibit	No
Master Int.Hold	No
Slave Int.Hold	No

Figure 104 Main menu

Master PV	This is the process value for the outer (master) loop of cascade control, typically obtained from an analogue input.
Master WSP	This is the (read only) working setpoint for the outer (master) loop of cascade control. The Master WSP can obtain its value from one of a number of sources such as 'Internal SP' or 'Remote SP'.
Target setpoint	The target setpoint is the value which the outer (master) control loop is attempting to reach. The value may come from one of a number of sources, such as 'Internal SP' or 'Remote SP'.
Slave PV	This is the process value for the inner (slave) loop of cascade control, typically wired from an analogue input.
Slave WSP	This is the (read only) working setpoint for the inner (slave) loop. The value may come from one of a number of sources, such as the output from the master loop or the local slave setpoint.
Working Output	The actual output of the inner (slave) loop before it is split into channel 1 and channel 2 outputs.
Cascade Mode	Slave: Also known as 'Slave Local Auto', this is a single loop controlling with a local setpoint. Manual: Also known as 'Slave Manual', this provides a single manual power setting for the slave. Cascade: (Full) cascade. In this mode, the master is in 'Auto' mode and provides the setpoint for the slave.
Inhibit	If set to 'Yes', both outer (master) loop and inner (slave) loops stop controlling and the output of the slave loop is set to the safe output value (SafeOp) set in the Output menu ("Advanced Loop Output menu" on page 167).
Master Int.Hold	If set to 'Yes', the integral component of the outer (master) loop PID calculation is held at its current value and does not integrate any further disturbances in the plant. Essentially this is equivalent to switching into PD control with a manual reset value pre-configured.
Slave Int.Hold	As for Master.IntHold, above, but for the inner (slave) loop.

Advanced Loop Setup menu

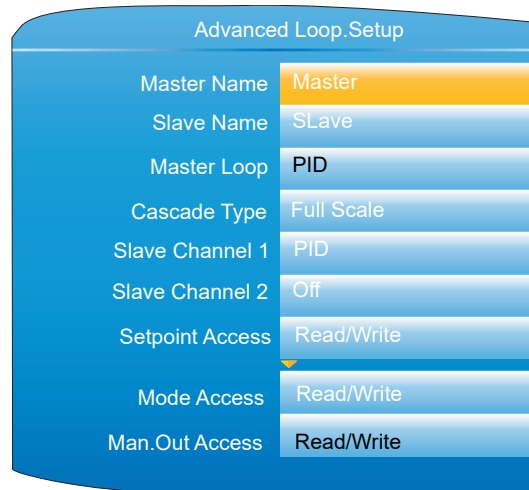

Figure 105 Advanced Loop Setup menu

Master Name	Allows the user to enter a 10-character string for the Master loop name in the Cascade display page ("Cascade Display Mode" on page 58).
Slave Name	As above, but for the slave loop.
Master Loop	The control algorithm for the master control loop (PID only for this software release).
Cascade Type	Full Scale: The master generates a setpoint (between SP High limit and SP Low limit) for the slave. Trim: The master working setpoint is used as the base setpoint of the slave. This is then modified by the addition of a setpoint trim, to become the target setpoint for the slave. The PID output from the master is mapped to range set by Trim Range High and Trim Range Low.
Slave Channel 1	Selects the channel 1 control algorithm. Different algorithms can be selected for channels 1 and 2. In temperature control applications, channel 1 is usually the heating channel, and channel 2 the cooling channel. PID: Control Output Configured as PID. VPB: Control Output Configured as Bounded VP. Bounded VP is implemented as a PID algorithm driving a position loop and is used in systems with position feedback.
Slave Channel 2	Selects the channel 2 control algorithm. Different algorithms can be selected for channels 1 and 2. In temperature control applications, channel 1 is usually the heating channel, channel 2 the cooling channel. Off: Control output is not configured. PID: Control Output Configured as PID.
Setpoint Access	Allows the user to select 'Read Only', 'Read/Write', or 'Operator R/W' for setpoint access, where 'Operator R/W' means that the setpoint is read write for access levels operator and above, but read only in Logged out mode.
Mode Access	As for 'Setpoint Access', above, but for Auto/Manual mode switching.
Man.Out Access	As for 'Setpoint Access', above, but configures the read/write access for the Manual Output parameter.

Advanced Loop Tune menu

The screenshot shows the 'Advanced Loop.Tune' menu with the following parameters and values:

Parameter	Value
Tune Type	Master
Tune Enable	Off
Tune Slave R2G	Standard
Tune High	1372.0
Tune Low	-20
Output High	100.0%
Output Low	0.0%
State	Off
Stage	Reset
Stage Time	<input checked="" type="checkbox"/> sec
Diagnostics	<input checked="" type="checkbox"/>
Hysteresis	1.0
Band	5.0
Timeout	7200 sec
OPDel	0.00
WSP	0.0
ModeMan	1
OP	0.0
MasterTune	0
TuneSlave	0.0
TuneStatus	0
Mod_PV	0.0
Mod_OP	0.0
Arg_PV	0.0
Arg_OP	0.0
Gain	0.0
Phase	0.0
Period	0.0
A1	0 sec
A2	0

A bracket on the right side of the menu indicates that the following items appear only if 'Tune Type' = 'Master' and if 'Diagnostics' is enabled (ticked) as shown. (default = disabled)

Figure 106 Advanced Loop Tune menu

Tune Type	Select 'Master' or 'Slave' for the Tuning process.
Tune Slave R2G	Appears only if the Slave channel 2 is set to 'PID' in the Setup menu ("Advanced Loop Setup menu" on page 154), and Tune Type is set to Slave in the Advanced Loop.Tune menu. Standard: Normal compensation applied to account for differences in heating and cooling efficiencies between the heating and cooling channels. R2GPD: Typically used in heavily lagged systems.
Tune Enable	Allows the user to initiate an autotune.
Tune High	State Sets the maximum value for the master loop setpoint during the tuning process.
Tune Low	Sets the minimum value for the master loop setpoint during

Output High	The maximum output power level which the controller may supply during the tuning process. If 'Output High' in the Output menu ("Advanced Loop Output menu" on page 167) is lower than 'High Output' then the maximum output is clipped to the 'Output High' value.
Output Low	The minimum output power level which the controller may supply during the tuning process. If 'Output Low' in the Output menu ("Advanced Loop Output menu" on page 167) is higher than 'Low Output' then the minimum output is clipped to the 'Output Low' value.
State	The current autotune state. Off: Autotune not enabled. Ready: Fleeting display. Changes immediately to 'Running'. Running: Autotune running. Complete: The tune process completed successfully. Fleeting display before returning to 'Off'. Time-Out: A timeout error has occurred and the autotune has been aborted. Ti Limit. R2G Limit.
Stage	Reset. None. Settling. Current SP. New SP. To SP. Wait Max. Wait Min. Store. CoolT. PID. Abort. Complete. NewR2G. 1:Half Cycle. 2:Full Cycle. 3:Full Cycle. 4:FinalCycle. 5:Calc.
Stage Time	Elapsed time since entering this stage of the tuning.
Diagnostics	If this is enabled, a number of further parameters become visible.
Hysteresis	This defines the hysteresis of the switch used during master autotuning to generate the oscillation. It is set as a percentage of the master PV range (High Range - Low Range) in engineering units being +/- Hysteresis/2 about the tuning setpoint.
Band	This defines the band between which the setpoint of the slave controller will be switched during the master autotune oscillation. It is set as a percentage of the master PV (High Range -Low Range) in engineering units being +/- Band/2 about the tuning setpoint. The actual values applied to the slave may actually be constrained inside this band by the wind-up control mechanism.
Timeout	Defines the maximum time permitted for each stage of the master tuning.
OPDel	This is an internal setting of the order of 0.5 during tuning.
WSP	This is the actual setpoint around which the autotuning oscillation of the master takes place. It is used for the calculations associated with the Hysteresis and Band

ModeMan	This parameter is used by the master autotune algorithm to communicate with the master loop. Puts master controller into 'Not-Auto' mode.
OP	This signal is generated within the master loop during the autotune oscillation. It is used only as an input to the calculations which generate the slave loop setpoint. It is not the overall loop output to the load which at all times is under the control of the slave PID calculations.
MasterTune	Master tune in progress.
TuneSlave	The autotune process is requesting a slave tune.
Tune Status	This indicates the internal stage of tuning. 0 = Not tuning 1 = Tuning the slave 2 = Tuning the master 3 = Tuning completed -1 = Tuning has aborted or timed-out
Mod_PV	This is the amplitude of the fundamental component of the master PV during the last cycle of the tuning oscillation.
Mod_OP	This is the amplitude of the fundamental component of the master OP during the last cycle of the tuning oscillation.
Arg_PV	This is the argument (phase) of the fundamental component of the master PV during the last cycle of the tuning oscillation. Value in radians.
Arg_OP	This is the argument (phase) of the fundamental component of the master OP during the last cycle of the tuning oscillation. Value in radians.
Gain	This is the gain between the master OP and the master PV over the path via the slave loop and the load, measured at the fundamental frequency of the autotuning oscillation.
Phase	The phase shift in radians between the master OP and the master PV over the path via the slave loop and the load, measured at the fundamental frequency of the autotuning oscillation.
Period	This is the period of the last cycle of the autotune oscillation, in seconds.
A1	This is the number of samples actually taken in order to determine the fundamental components of the master PV and OP. The target number is around 100 samples but the actual number taken may differ slightly from this depending on the load's behaviour.
A2	The A2 parameter is used for diagnostic purposes. Its value indicates the design method chosen by the algorithm which depends on the characteristics of the master tuning oscillation and the measured values of frequency, gain, and phase shift around the master loop. This influences the choices of the P, I and D values set into the master loop.
Alpha_p	R2GPD tuning diagnostic parameter: Heat time / cool time.
OPss	R2GPD tuning diagnostic parameter: Steady state output at the end of the settling period.
Alpha	R2GPD tuning diagnostic parameter: 1/R2G.
Debug	R2GPD tuning diagnostic parameter: 0-PID, 1-PI, 2-PD, 3-P.
CycleNo	R2GPD tuning diagnostic parameter: Number of cycles in auto tune sequence.
PBs	R2GPD tuning diagnostic parameter: PBs scales the proportional band which will be used in the PD settling period.

TDs	R2GPD tuning diagnostic parameter: TDs scales the derivative value which will be used during the PD settling period.
Settle	R2GPD tuning diagnostic parameter: Used to scale the last cycle time. The result will be used for the PD settling time.

Advanced Loop Master PID menu

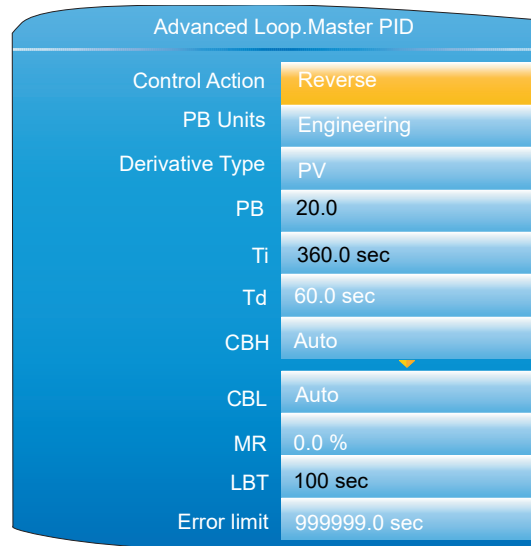

Figure 107 Advanced Loop master PID menu

Control Action	Select 'Reverse' or 'Direct'. 'Reverse' means that the output is 'on' when the process value (PV) is below the target setpoint (SP). This is normal for heating control. 'Direct' means that the output is on when PV is above SP. This is normal for cooling control.
PB Units	Select 'Engineering' or 'Percent'. 'Engineering' displays values in (for example) temperature units (e.g. °C or °F). 'Percent' displays values as a percentage of loop span (Range High - Range Low).
Deriv Type	'Error' means that changes to PV or SP cause changes to the derivative output. Derivative on error should be used with a programmer since it tends to reduce ramp overshoot. 'Error' provides rapid response to small setpoint changes which makes it ideal for temperature control systems. 'PV' means that changes in PV alone cause changes to the derivative output. Typically used for process systems using valve control, as it reduces wear on the valve mechanics.
PB	Proportional band. The proportional term in the units (Engineering units or %) set in 'PBUnits' above. See "PID Control" on page 401 for more details.
Ti	Integral time constant. Valid entries are 1 to 9999.9 seconds, or 'Off'. If set Off, then integral action is disabled. Removes steady state control offsets by moving the output up or down at a rate proportional to the error signal.
Td	Derivative time constant. Valid entries are 1 to 9999.9 seconds, or 'Off'. If set Off, then derivative action is disabled.

rate-of-change in the PV. Used to control overshoot and undershoot and to restore the PV rapidly if there is a sudden change in demand.

CBH Cutback high. Valid entries 'Auto' (3'PB) or 0.1 to 9999.9. The number of display units above setpoint at which the controller output is forced to 0% or -100% (OP min), in order to modify undershoot on cool down. See "High and Low cutback" on page 405 for more details.

CBL Cutback low. Valid entries 'Auto' (3'PB) or 0.1 to 9999.9. The number of display units below setpoint at which the controller output is forced to 100% (OP max), in order to modify overshoot on heat up. See "High and Low cutback" on page 405 for more details.

MR Manual reset. Valid entries -100% to +100%. Introduces a fixed additional power level to the output in order to eliminate steady state error from proportional only control. Applied instead of the integral component when Ti is set to 'Off'.

LBT Loop break time. Valid entries are 1 to 99999 seconds, or 'Off'. See "Loop Break" on page 406 for more details.

Advanced Loop Slave PID menu

Advanced Loop Slave PID	
Control Action	Reverse
PB Units	Engineering
Derivative Type	Error
Sched Type	Remote
Number of Sets	3
Remote Input	0
Active Set	Set3
Boundary 1-2	0
Boundary 2-3	0
PB	20.0
Ti	360 sec
Td	60 sec
R2G	1.0
CBH	Auto
CBL	Auto
MR	0.0%
LBT	100 sec
Output Low	-100%
Output High	100%
PB2	23.0
Ti2	360.0 sec
Output Low 3	-90.0%
Output High 3	90.0%

Figure 108 Advanced Loop Slave PID Menu (Typical)

Control Action Select 'Reverse' or 'Direct'.
'Reverse' means that the output is 'on' when the process

	for heating control. 'Direct' means that the output is 'on' when PV is above SP. This is normal for cooling control.
PB Units	Select 'Engineering' or 'Percent'. 'Engineering' displays values in (for example) temperature units (e.g. °C or °F). 'Percent' displays values as a percentage of loop span (Range High - Range Low).
Deriv Type	'Error' means that changes to PV or SP cause changes to the derivative output. Derivative on error should be used with a programmer since it tends to reduce ramp overshoot. 'Error' provides rapid response to small setpoint changes which makes it ideal for temperature control systems. 'PV' means that changes in PV alone cause changes to the derivative output. Typically used for process systems using valve control, as it reduces wear on the valve mechanics.
Sched Type	Selects the type of Gain Scheduling ("Gain Scheduling" on page 407) to be applied. Off. Gain Scheduling not active. Set. The user selects the PID parameter set to be used. Setpoint. Transfer from one set to the next depends on the setpoint value. PV. The transfer from one set to another depends on the PV value. Error. The transfer between sets depends on the value of the error signal. OP. Transfer depends on the value of the output. Rem. Transfer is controlled by a remote input.
Number of Sets	Allows the number of sets of PID parameters for use in Gain scheduling to be selected.
Remote input	For 'Sched Type' = 'Rem' only, this shows the current value of the remote input channel being used to select which set is active. If the remote input value = the Boundary 1-2 value (see below) then set 1 is selected. If it is > Boundary 1-2 value but = Boundary 2-3 value then set 2 is used. If the remote value is > Boundary 2-3 value, then set three is used. If the Remote input is not 'wired', the value is user editable from the front panel.
Active Set	The set number currently in use.
Boundary 1-2	For all Sched Types except 'Set', this allows the user to enter a 'boundary' value, which means that if the relevant value (SP, PV, Error etc.) rises above this boundary, the loop switches from PID set 1 to PID set 2. If it falls below the boundary value, the loop switches from set 2 to set 1.
Boundary 2-3	As above but for switching between sets 2 and 3.
PB/PB2/PB3	Proportional band for set one/two/three. The proportional term in the units (Engineering units or %) set in 'PBUnits' in the Setup menu. See "PID Control" on page 401 for more details.
Ti/Ti2/Ti3	Integral time constant for set one/two/three. Valid entries are 1 to 9999.9 seconds, or 'Off'. If set Off, then integral action is disabled. Removes steady state control offsets by moving the output up or down at a rate proportional to the error signal.
Td/Td2/Td3	Derivative time constant for set one/two/three. Valid entries are 1 to 9999.9 seconds, or 'Off'. If set Off, then derivative action is disabled. Determines how strongly the controller reacts to the rate-of-change in the PV. Used to

	control overshoot and undershoot and to restore the PV rapidly if there is a sudden change in demand.
R2G/R2G2/R2G3	Relative cool gain for set one/two/three. Appears only if cooling has been configured (Ch2 Control not 'Off' in the Setup menu). Valid entries are 0.1 to 10. Sets the cooling proportional band which compensates for differences between heating and cooling power gains.
CBH/CBH2/CBH3	Cutback high for set one/two/three. Valid entries 'Auto' (3'PB) or 0.1 to 9999.9. The number of display units above setpoint at which the controller output is forced to 0% or -100% (OP min), in order to modify undershoot on cool down. See "High and Low cutback" on page 405 for more details.
CBL/CBL2/CBL3	Cutback low for set one/two/three. Valid entries 'Auto' (3'PB) or 0.1 to 9999.9. The number of display units below setpoint at which the controller output is forced to 100% (OP max), in order to modify overshoot on heat up. See Section B2.3.2 for more details.
MR/MR2/MR3	Manual reset for set one/two/three. Valid entries 0 to 100%. Introduces a fixed additional power level to the output in order to eliminate steady state error from proportional only control. Applied instead of the integral component when Ti is set to 'Off'.
LBT/LBT2/LBT3	Loop break time for set one/two/three. Valid entries are 1 to 99999 seconds, or 'Off'. See "Loop Break" on page 406 for more details.
Output Low/2/3	Output low limit for set one/two/three. Valid entries are in the range Output High/2/3 to -100.
Output High/2/3	Output high limit for set one/two/three. Valid entries are in the range Output Low/2/3 to +100.

Advanced Loop Master SP menu

Advanced Loop.Master.SP	
Range High	1372.0 V
Range Low	-200 V
SP Select	SP1
SP1	-0.9 V
SP2	0.0 V
SP High Limit	1372.0 V
SP Low Limit	-200.0 V
Alt SP Enable	No
Alt SP	0.0 V
Rate	123
Rate Done	No
SP Rate Disable	No
Servo to PV	No
SP Trim	0.0 V
SP Trim High	0.0 V
SP Trim Low	0.0 V
Manual Track	On
Setpoint Track	On
Track PV	31.5 V
Track SP	-0.9 V
SP Int Balance	<input checked="" type="checkbox"/>

Figure 109 Advanced Loop Master SP menu

Range High/Low	Range limits. Range limits set absolute maxima and minima for control loop setpoints. If the proportional band is configured as a percentage span, the span is derived from the range limits.
SP select	Select SP1 or SP2. SP1 is often considered to be the primary setpoint for the controller, and SP2 a secondary setpoint.
SP1, SP2	Allows values for Setpoints 1 and 2 to be entered. Valid entries are any within the range 'SPHigh Limit' to 'SPLow-Lim'.
SP High Limit	Maximum setpoint limit for SP1 and SP2. Valid entries are in the range 'Range Hi' and 'SP Low Limit'.
SP Low Limit	Minimum setpoint limit for SP1 and SP2. Valid entries are in the range 'Range Lo' and 'SP High Limit'.
Alt SP Enable	'Yes' enables the alternative setpoint; 'No' disables it. May be wired to an external or internal source.
Alt SP	When wired this is a read only display of the alternative setpoint value. Otherwise, the user may insert a value. Valid values are limited by 'Range Hi' and 'Range Lo'.
Rate	Sets the maximum rate at which the working setpoint may change in Engineering units per minute. Often used to protect the load from thermal shock caused by large step changes in setpoint. 'Off' disables rate limiting.

Rate Done	Read only display. 'Yes' indicates that the working setpoint has completed its change. 'No' indicates that the setpoint is still ramping.
SP Rate Disable	Appears only if Rate is not 'Off'. 'Yes' disables rate limiting; 'No' enables rate limiting.
Servo To PV	If 'Rate' is set to any value other than 'Off', and if 'Servo to PV' is set to 'Yes' then any change in the current setpoint value causes the working setpoint to servo to the current PV before ramping to the new setpoint value.
SP Trim	A positive or negative value added to the setpoint, for local fine tuning. Valid entries are any value between 'SP Trim High' and 'SP Trim Low'.
SP Trim High/Low	Setpoint trim high and low limits.
Manual Track	'On' enables manual tracking. Manual tracking removes steps in setpoint when switching between 'Man' and 'Auto' modes. When the loop is switched from manual to auto the target setpoint is set to the current PV. See "Manual Tracking" on page 423 for more details. 'Off' disables manual tracking.
Setpoint Track	'On' enables setpoint tracking. When setpoint tracking is enabled, it ensures 'bumpless' transfer in setpoint when switching from Alternative setpoint to a local setpoint. See "Setpoint Tracking" on page 423 for more details. 'Off' disables setpoint tracking.
Track PV	The unit tracks the PV when it is servoing or tracking.
Track SP	The SP to track in manual tracking -see 'Setpoint Track', above.
SP Int Balance	Allows the user to enable (tick) or disable (cross) debump on PV change.

Advanced Loop Slave SP menu

Advanced Loop.Slave.SP	
Range High	1372.0 V
Range Low	-200 V
SP High Limit	1372.0
SP Low Limit	-200
Local SP	1372.0
Trim Range High	100.0
Trim Range Low	-100.0
Trim High Limit	100.0 V
Trim Low Limit	-100 V
Remote FF	0.0
Remote FF Enable	No
Remote FF High	1372.0
Remote FF Low	-200
Manual Track	Off
Sbrk Mode	SbrkSP
Sbrk SP	0.0

Figure 110 Advanced Loop Slave Setpoint menu

Range High/Low	Range limits. Valid entries from 99999 to -99999. Range limits set absolute maxima and minima for control loop setpoints. If the proportional band is configured as a percentage span, the span is derived from the range limits.
SP High Limit	Maximum setpoint limit for the local setpoint. Valid entries are in the range 'Range Hi' and 'SP Low Limit'.
SP Low Limit	Minimum setpoint limit for the local setpoint. Valid entries are in the range 'Range Lo' and 'SP High Limit'.
Local SP	The Slave local setpoint.
Trim Range High	Trim Range upper limit. Appears only if 'Cascade type' has been set to 'Trim' in the Setup menu (Figure 105).
Trim Range Low	Trim Range lower limit. Appears only if 'Cascade type' has been set to 'Trim' in the Setup menu (Figure 105).
Trim High Limit	Maximum value for Trim High value. Appears only if 'Cascade type' has been set to 'Trim' in the Setup menu (Figure 105).
Trim Low Limit	Minimum value for Trim Low value. Appears only if 'Cascade type' has been set to 'Trim' in the Setup menu (Figure 105).
Remote FF	The current remote feedforward value.
Remote FF Enable	Enables or disables the use of a remote Feedforward signal. Appears only if 'Cascade type' has been set to 'Full Scale' in the Setup menu (Figure 105).
Remote FF High	High limit for the remote feedforward signal value. Appears only if 'Cascade type' has been set to 'Full Scale' in the Setup menu (Figure 105).
Remote FF Low	Low limit for the remote feedforward signal value. Appears only if 'Cascade type' has been set to 'Full Scale' in the Setup menu (Figure 105).
FF Select	Allows the user to select the source of the feedforward signal from 'master PV', 'Master working setpoint' or 'Remote FF'. Appears only if 'Cascade type' has been set to 'Trim' in the Setup menu (Figure 105).
Manual Track	'On' enables manual tracking to allow the local SP to follow the value of the current PV to allow bumpless transfer when switching to Auto. See "Manual Tracking" on page 423 for more details. 'Off' disables manual tracking.
Sbrk Mode	Master sensor break mode. This defines the behaviour when the master loop PV is bad i.e. the sensor has failed. Value options: 0: SbrkSP If the master sensor is broken and the mode is cascade, the slave setpoint will be set to the SbrkSP. 1: Hold If the master sensor is broken, the master loop will freeze at the last output (setpoint) value calculated before the sensor broke. 2: SlaveSB If the master sensor is broken, the strategy will switch to the configured slave sensor break mode.
Sbrk SP	Sensor break setpoint. This is the setpoint for the slave loop when the master sensor has gone into sensor break and the sensor break mode for the master is set to SbrkSP.

Cascade Full Scale Mode

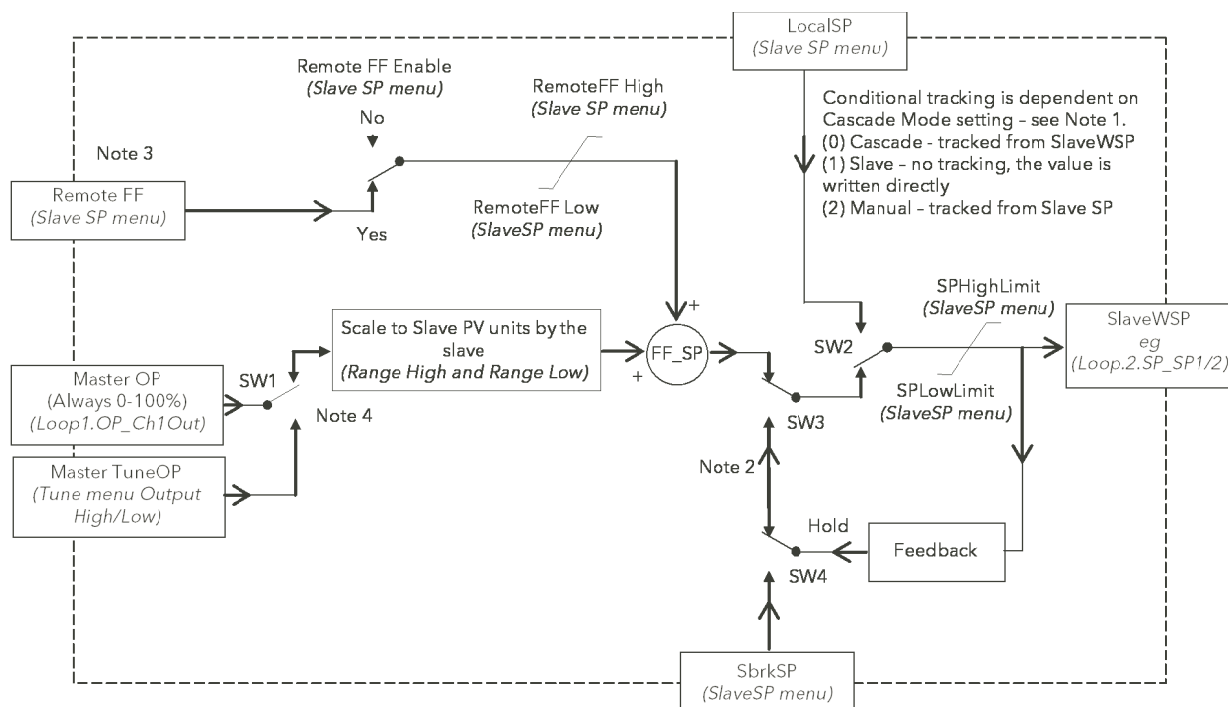

Figure 111 Cascade Full Scale Mode Block Diagram

Note: The parameter 'Cascade Mode' (Advanced Loop/Main menu) has three settings:

Cascade	The master loop has full control of the slave setpoint which is read only and tracks the value written by the master.
Slave	The master loop no longer controls the slave setpoint, which has been made read/write, and can be changed manually over comms. The switch away from the master's control (SW2) is bumpless and any subsequent return to Cascade control is also bumpless. The limits to the slave setpoint which have been defined in SP High Limit and SP Low Limit are still applied.
Manual	The slave loop is in a conventional manual control situation where the loop output is controlled manually or over comms. Bumpless switching is still applied in both directions when switching between manual and slave states.

Note: This applies to operation of SW2, SW3 and SW4 when the loop is in cascade mode and the master sensor fails (Master Sensor Break).

The parameter 'Master Sensor Break Mode' (In Advanced Loop Slave SP) has three selections to define what happens in this situation.

SbrkSP (2)	With this setting the Slave Loop Setpoint will be set to the value set in SbrkSP.
Hold (1)	This will arrange SW3 and SW4 so that the slave loop setpoint will be locked at the current value via the Feedback path.
SlaveSB (2)	This will cause the slave loop's own setting (in Advanced Loop/ Output) to be implemented. This has two options.
SbrkOP (0)	The value set in Advanced Loop/Output/Sensor break output will be used to set the output level from the loop.
Hold (1)	The output value will be held at its current level.

Note: 'Remote Feedforward' in the Advanced Loop/Slave SP menu needs to be soft

Note: SW1 operates during auto tuning of the master loop. The parameters Tune/Output High Limit and Output Low Limit restrict the limits of the output from the master loop (which is scaled to become the setpoint for the slave loop). Care is needed in choosing these values to ensure that the tuning setpoint of the slave loop is achievable. Excessive restriction of the setpoint may prevent completion of the tuning process.

Cascade Trim Mode

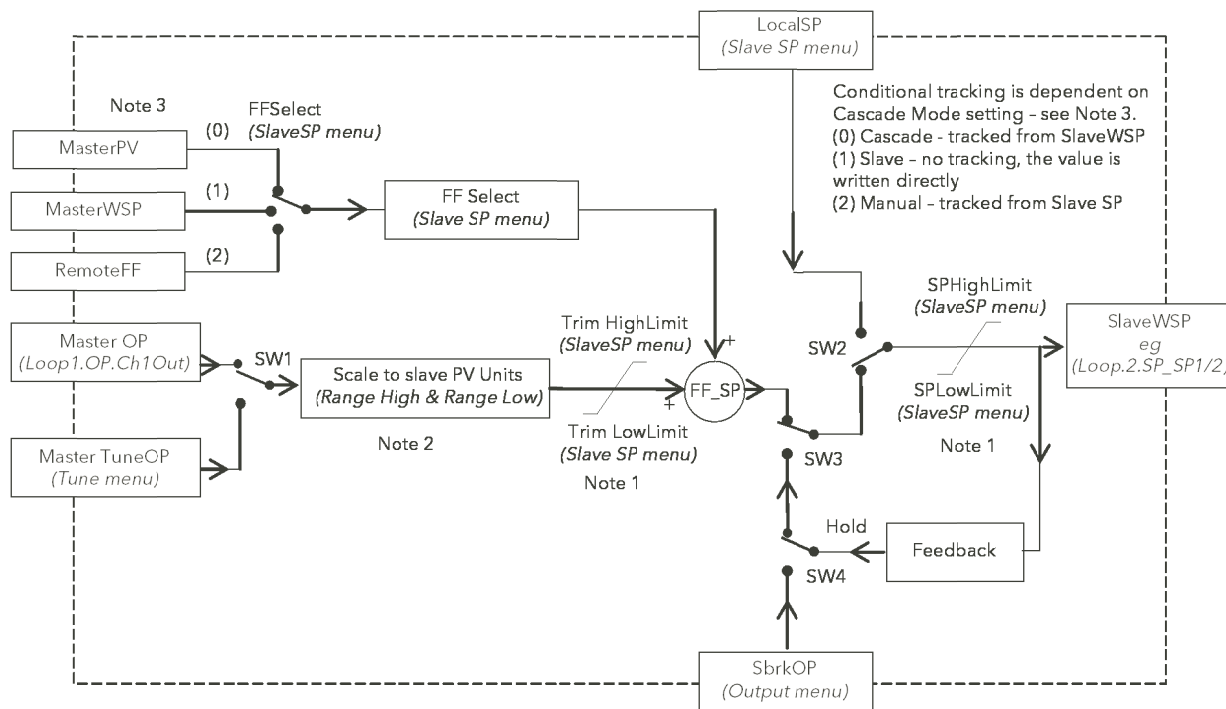

Figure 112 Cascade Trim Mode Block Diagram

Notes:

1. In both Master and Slave loops the setpoint limits only RESTRICT the setpoint value range which can be used. They have NO EFFECT on the calculation of the proportional bands.
2. Range High and Range Low parameters in each of the loops (Adv.Loop.Master.SP and Adv.Loop.Slave.SP) are absolute max. and min. values and are used in the proportional band calculations. Changing these values within a loop which is tuned will require re-tuning of the associated loop.
3. Cascade mode in the Main menu allows selection of the three ways in which the Advanced Loop can operate.
 - (0) Cascade Both master and slave loops are operating. Target Setpoint defines the controlled temperature at the master sensor. LocalSP in the Slave Loop tracks the SlaveWSP.
 - (1) Slave The master loop is not influencing the controlled temperature. This is set by the value of LocalSP. This can now be directly modified and defines the temperature at which the slave sensor will be controlled.
 - (2) Manual The level of the heater power is directly controlled manually. LocalSP will track the temperature at the slave sensor.

Advanced Loop Output menu

"Output" on page 423 contains details of the output functions.

Advanced Loop Output	
Output High	100 %
Output Low	-100 %
Ch1 Output	0.0
Ch2 Output	0.0
Ch2 Deadband	Off
Rate	15
Rate Disable	No
Ch1 Travel Time	22.0 sec
Ch2 Travel Time	22.0 sec
Ch1 Pot Pos	0
Ch1 Pot Brk	Off
Ch2 Pot Pos	0
Ch2 Pot Brk	Off
Pot Brk Mode	Raise
Sbrk Mode	Safe
Sbrk OP	0.0 %
Safe OP	0.0 %
Manual Mode	Track
Manual Output	0.0 %
Forced Output	0.0 %
Manual Startup	X
Pff En	Yes
Line Voltage	218 V
Cool Type	Linear
FF Type	SP
FF Gain	1.000
FF Offset	0
FF Trim Limit'	100
FF Remote	
FF Output	0 %
Track Output	0
Track Enable	Off
Rem. Output Low	-100 %
Rem. Output High	100 %

Figure 113 Advanced Loop Output menu

Output High

The maximum output power to be delivered by channels 1 and 2, where 100% is full power. The valid input range is Output Low to 100.0%. Reducing this value reduces the rate of change of the process, but it also reduces the controller's ability to react to perturbations and can even cause it to fail to achieve setpoint.

Output Low	The minimum power, or the maximum 'negative' (i.e. cooling) power to be delivered by the system.
Ch1 Output	Displays the positive power values used by the heat output.
Ch2 Output	Displays the cooling power values for channel two. Appears as a value between Output High and -100%, where -100% represents full cooling power.
Ch2 Deadband	A gap (in percent) between output 1 switching off, and output 2 switching on, and viceversa. Valid inputs are 0 (off) to 100%.
Rate	Limit on the rate at which the output from the PID can change. Can be useful in preventing rapid changes in output that could damage the process, heater elements etc.
Rate Disable	The Output Rate limit may be disabled by setting its value to 0.0. Alternatively, for some applications it is useful to be able to wire to the Output Rate Disable so that 'Rate' can be switched on/off during stages of the process. For example, Rate Disable can be used with the programmer event outputs to control the output rate of change during a particular segment.
Ch1 Travel Time	Appears only if Setup menu (Figure 105) parameter 'Slave Channel 1' is set to 'VPB'. This is the valve travel time from closed (0%) to open (100%). In a valve positioning application, channel 1 output is connected by a single software 'wire' to a Valve Raise/Valve Lower relay pair. For heat/cool applications, channel 1 is associated with the heating valve. Valid entries: 0.0 to 1000.0 seconds.
Ch2 Travel Time	Appears only if Setup menu (Figure 105) parameter 'Slave Channel 2' is set to 'VPB'. This is the valve travel time from closed (0%) to open (100%). For heat/cool applications, channel 2 is associated with the cooling valve. Valid entries: 0.0 to 1000.0 seconds.
Ch1 Pot Pos*	The position of the channel one actuator as measured by the feedback potentiometer.
Ch1 Pot Brk*	'On' indicates that the input to the relevant channel is open circuit.
Ch2 Pot Pos*	The position of the channel two actuator as measured by the feedback potentiometer.
Ch2 Pot Brk*	'On' indicates that the input to the relevant channel is open circuit.
Pot Brk Mode*	Defines the action to be taken if a potentiometer break is detected: Raise: opens the valve Lower: closes the valve Rest: the valve remains in its current state. Model: the controller tracks the position of the valve and sets up a model of the system so that it continues to function if the potentiometer becomes faulty. This does not mean that the potentiometer can be omitted with VPB, as the accuracy of valve position control is reduced without it.

Note: These parameters appear only if the 'Setup' menu parameter 'Slave Channel 1' or 'Slave Channel 2' (as appropriate) is set to 'VPB'. The Setup menu is described in "Advanced Loop Setup menu" on page 154.

SBrk Mode	Defines the action to be taken in the event of a sensor break. Safe: The output adopts the value configured in 'Sbrk OP', below. Hold: The output remains at its current level.
-----------	---

Sbrk OP	The value to be output if a Slave sensor break occurs, and SBrk Mode (above) is set to 'Safe'.
Safe OP	The output level adopted when the loop is inhibited (Main menu "Advanced Loop Main menu" on page 153).
Manual Mode	Selects the type of transition to occur when changing to manual cascade mode ("Advanced Loop Main menu" on page 153): Track: Whilst in Auto mode, the manual output tracks the control output so that there is no change of output when manual mode is switched to. Step: On transition to manual mode, the output is set to the value entered for 'Forced-OP' (below). Last Man. Out: On transition to manual mode, the output adopts the manual output value as last set by the operator.
Manual Output	The output when the loop is in manual mode. In manual mode the controller limits the maximum power, but it is not recommended that it be left unattended at high power settings. It is important that over range alarms are fitted to protect the process.

Note: It is recommended that all processes are fitted with an independent over range detection system.

Forced Output	Forced Manual output value. When 'Manual Mode' = 'Step', this is the output value adopted when changing from Auto to Manual mode.
Manual Startup	When set to off (cross symbol), the controller powers up in the same (auto or manual) mode that obtained when it was switched off. When set to on (tick symbol) the controller always powers up in manual mode.
Pff En	Power feed forward enable. 'Yes' enables power feed forward (adjusts the output signal to compensate for variations in supply voltage. 'No' disables Pff. See "Power Feed Forward" on page 426 for further details.
Line Voltage	Read only display of the current supply voltage.
Cool Type	Appears only if 'Ch2 Control' = 'PID' in the setup menu ("Advanced Loop Setup menu" on page 154) and allows the user to enter the appropriate type of cooling ("Cool Type" on page 426): Linear: For use when controller output changes linearly with PID demand. Oil: For oil cooled applications. Water: For water cooled applications. Fan: For forced air cooling.
FF Type	Feed forward type ("Feed forward" on page 427): None: No signal fed forward. Remote: A remote signal is fed forward. SP: Setpoint is fed forward. PV: PV is fed forward.
FF Gain	For FF types 'PV' and 'SP', this scales the feed forward signal.
FF Offset	For FF types 'PV' and 'SP', this defines the offset of the scaled feed forward signal.
FF Trim Limit	For FF types 'PV' and 'SP', defines symmetrical limits about the PID output which are applied to the scaled feed forward signal.
FF Remote	Allows another value from the strategy to be used as the primary control variable in the feed forward strategy. The gain and offset are not applied to the remote value.
FF Output	For FF types 'PV' and 'SP', this is the calculated (scaled, offset and trimmed) feed forward signal. $FF\ OP = FF\ gain$

Track Output	If 'Track Enable' (below) is set to 'Yes', this is the value for the loop output to track when output track is enabled.
Track Enable	When set to 'Yes', the output follows the Track OP value (above). When subsequently set to 'Off' the loop makes a bumpless return to control.
Rem. Output Low/High	Used to limit the output when using a remote source. These limits cannot exceed the 'Output Low' and 'Output High' values described earlier in this section.

Advanced Loop Diagnostics menu

Master Error	The difference in value between the setpoint and the PV for the Master (Read only).
Slave Error	The difference in value between the setpoint and the PV for the Slave (Read only).
(M)Prop. Output	Shows the proportional term contribution to the control output of the Master (Read only).
(M)Integral Out	Shows the integral term contribution to the control output of the Master (Read only).
(M)Deriv. Output	Shows the derivative term contribution to the control output of the Master (Read only).
(S)Prop. Output	Shows the proportional term contribution to the control output of the Slave (Read only).
(S)Integral Out	Shows the integral term contribution to the control output of the Slave (Read only).
(S)Deriv. Output	Shows the derivative term contribution to the control output of the Slave (Read only).
Target Output	The requested control output. The target of the active output if rate limiting is active (Read only).
Loop Break (S)	Loop Break Alarm (Read only). Becomes active 'Yes' if the relevant loop break time (LBT1/2/3), set in the Slave PID menu ("Advanced Loop Slave PID menu" on page 159) is exceeded, otherwise 'No' is displayed.
Loop Break (M)	Loop Break Alarm (Read only). Becomes active 'Yes' if the Master loop break time (LBT), set in the Master PID menu ("Advanced Loop Master PID menu" on page 158) is exceeded, otherwise 'No' is displayed.
Sensor Break (S)	Indicates Slave sensor break status (Read only). On (tick symbol) indicates a sensor break has occurred; Off (cross symbol) shows that no sensor breaks have been detected.
Sensor Break (M)	Indicates Master sensor break status (Read only). On (tick symbol) indicates a sensor break has occurred; Off (cross symbol) shows that no sensor breaks have been detected.
Sched PB	The scheduled proportional band for the current PID set.
Sched Ti	The scheduled integral time for the current PID set.
Sched Td	The scheduled derivative time for the current PID set.
Sched CBH	The scheduled cutback high value for the current PID set.
Sched CBL	The scheduled cutback low value for the current PID set.
Sched MR	The scheduled manual reset value for the current PID set.
Sched Loop Break	The scheduled loop break time for the current PID set.
Sched R2G	The scheduled relative cool gain value for the current PID set.
Sched Out High	The scheduled output high limit for the current PID set.
Sched Out Low	The scheduled output low limit for the current PID set.
Working Out Low	The low limit for the working output (Read only). This is the value used to limit the output power of the loop and is de-

	rived from the gain scheduled limit, the remote limit and the safety limit.
Working Out High	The high limit for the working output (Read only). This is the value used to limit the output power of the loop and is derived from the gain scheduled limit, the remote limit and the safety limit.
Master FB	Master FB is the value of the master control output after limiting and is used for Integral desaturation.
Calc OP	Master P+I+D.
HiSatLim	HiSatLim is an internally generated limit.
LoSatLim	LoSatLim is an internally generated limit.
OPPID	Master control output It will be the same as Calc OP if the master is not in Cutback.

Programmer Configuration

The programmer option allows the user to configure a setpoint program with one or two channels, as required. The program can be run from the Programmer operator display page ("Programmer Display Mode" on page 59) or can be controlled by inputs received from other parameters. In particular, the programmer is intended for use with the loop or advanced loop options.

The programmer configuration is separated into a number of areas as depicted in the overview below. The segment configuration (ramp type etc.) is carried out from the programmer edit page, also described in "Programmer Display Mode" on page 59.

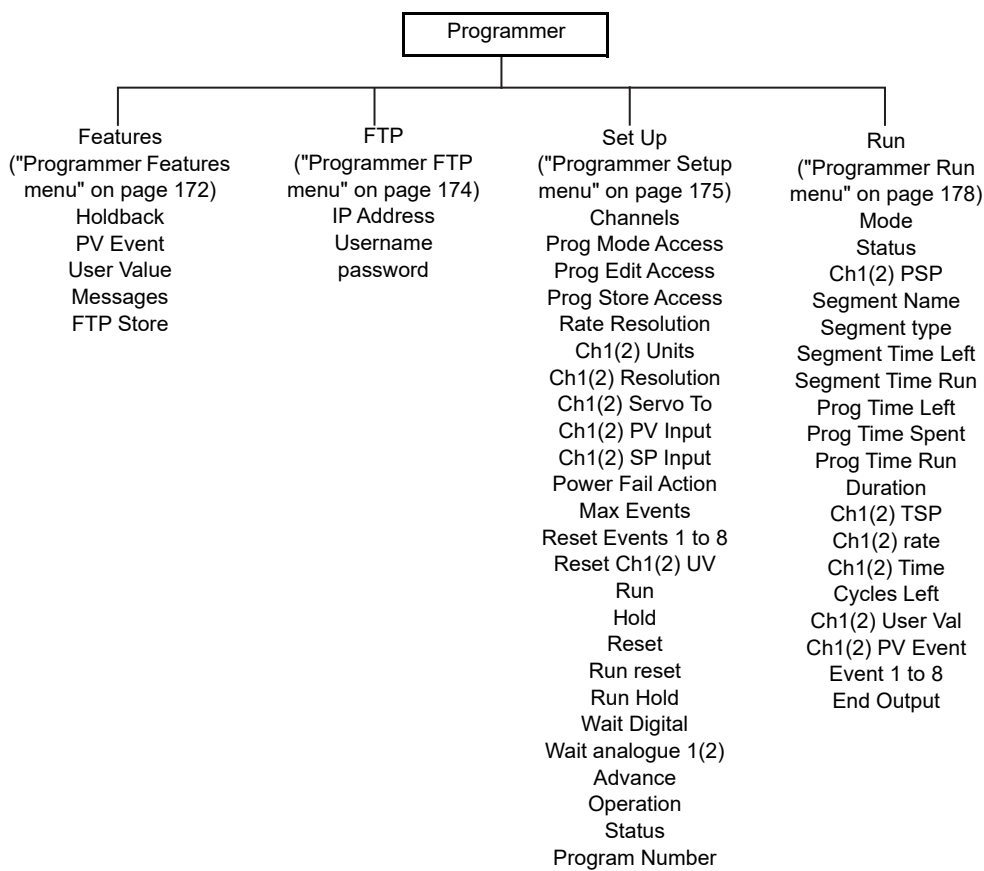

Programmer Features menu

This menu allows the user to enable/disable some of the items presented to the user in the Programmer edit page described in "Programmer Display Mode" on page 59. Features are enabled/disabled by using the up/down arrow keys to highlight the required item and then using the scroll button to toggle between enabled (tick) and disabled (cross). Typically, items would be left disabled in order to reduce the number of configuration fields presented to a user who may not need all such features.

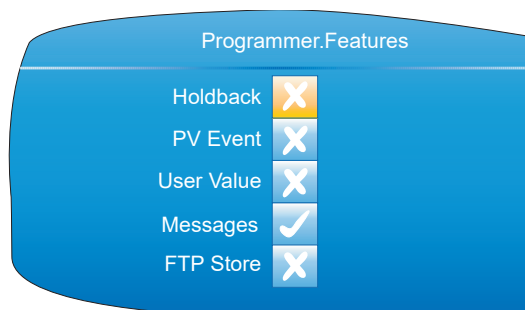

Figure 114 Programmer features menu

Holdback	Holdback pauses the program (freezes the Programmer setpoint (PSP) and the time remaining parameters) if the difference between the Process value (PV) and the PSP exceeds a user-specified amount (deviation). The program remains paused until the PV returns to within the specified deviation. In ramp or step segments, holdback indicates that the PV is lagging the SP by more than the specified amount and that the program is waiting for the process to catch up. In a dwell segment, holdback is used to guarantee that a work piece stays at set-point within a specified tolerance for the specified dwell duration. Holdback type and deviation value are configured, on a per program basis, to be applied to either the entire program or to individual segments. See Program edit ("Programmer Display Mode" on page 59) for details.
PV Event	A PV Event is available for each channel in every segment except for Wait and Go Back segment types. A PV Event is an absolute or deviation analogue alarm on the channel PV, and can be used to trigger a secondary process, or to trigger an analogue alarm.
User Value	A user value can be entered for every segment (except for Wait or Go Back types) and when the segment is entered, this value is transferred to the associated User Value Output parameter, which could be wired to another parameter to form part of an application strategy.
Messages	Figure 115 lists the programmer specific events that generate messages that are displayed in the message summary and recorded into the history file. It is also possible to trigger custom messages from any of the programmer outputs via user wiring. The program name and segment name can be embedded in custom messages by inserting the modbus address for the current program / segment name parameters in square brackets i.e.: [<current_program_name_modbus_address>] [<current_segment_name_modbus_address>]

Event	Message
Program Run	<program_name>: Run
Program End	<program_name>: Complete
Program Hold	<program_name>: <segment_name>: Hold
Program Resume	<program_name>: <segment_name>: Resume
Program Reset	<program_name>: <segment_name>: Reset
Segment Start	<program_name>: <segment_name>: Segment Start
Advance	<program_name>: <segment_name>: Advanced
Holdback	<program_name>: <segment_name>: Holdback:Channel No.
PV Event	<program_name>: <segment_name>: PV Eventchannel No.

Figure 115 Programmer messages

FTP Store

If this feature is enabled, an FTP menu item appears in the top level Programmer configuration menu. 'FTP' allows the user to enter communications parameters for the host computer which is to act as the ftp server. FTP Store allows the user to set-up a centralised program store from which several instruments can select their program.

Notes:

1. A maximum of 100 entries is supported on all drives. Directory trees are supported for both USB and FTP, and if the root of the drive contains only files (no directories), then up to 100 files are listed. If the root of the drive contains directories then each directory can contain 100 entries (but one of these entries will be taken up by '..' to return to the directory above).
2. Program files are in compressed XML (.uipz) file format.
3. As the loaded program resides in the current program database it is automatically included in a clone file. In addition, program files stored in the internal program drive are included in a clone file (refer to 'Cloning', below).
4. On the internal program drive only a flat directory structure is supported. However, full tree directories are supported on both the USB memory stick and FTP server (accessed via the HMI File Explorer).
5. It is not possible to store program files on an external device. Programs selected from an external device can, however, be stored in the internal program store.
6. It is not possible to select a program from an external device over comms and iTools.

Cloning

Each program file stored locally on the instrument IS included in a clone file as a Binary Large Object (BLOB), similar to the Graphical Wiring Editor layout. Each program file BLOB contains the program filename. When loading a clone file, existing programs in the instrument's internal drive are deleted, and program file BLOB(s) in the clone are reformatted into program files by the instrument.

Programmer FTP menu

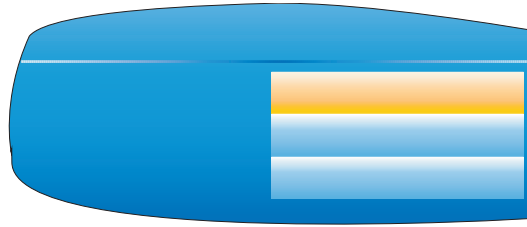

Figure 116 Programmer FTP menu

Note: This menu item is accessible only if 'FTP' has been enabled in the Programmer features menu described above.

IP Address	The IP address of the FTP server.
Username	The User Name entered when setting up the FTP server
Password	The password associated with the above User Name.

"Setting Up An FTP Server Using Filezilla" on page 431 gives an example of how to set up an FTP server using 'Filezilla'.

Programmer Setup menu

Programmer.Set Up	
Channels	2
Prog Mode Access	Operator
Prog Edit Access	Supervisor
Prog Store Access	Supervisor
Rate Resolution	1
Ch1 Units	Deg C
Ch1 Resolution	0
Ch1 Servo To	SP
Ch1 PV Input	23.7 V
Ch1 SP Input	0 Deg C
Ch2 Units	l/sec
Ch2 Resolution	1
Ch2 Servo To	PV
Ch2 PV Input	35.9 V
Ch2 SP Input	431 l/sec
Power Fail Action	Ramp back
Max Events	2
Reset Event 1	X
Reset Event 2	X
Reset Ch1 UV	0.0
Reset Ch2 UV	0.0
Run	No
Hold	No
Reset	Yes
Run Reset	No
Run Hold	No
Wait Digital	X
Wait Analog 1	10
Wait Analog 2	39.7
Advance	No
Operation	Select...
Status	Success
Program Num	1

Figure 117 Programmer Set Up menu

- Channels** The number of channels to be profiled. 1 = single channel mode, 2 = dual channel sync-all mode.
- Prog Mode Access** Sets the minimum access level (Logged off, Operator, Supervisor) for allowing changes to the current program mode (run, hold or reset).
- Prog Edit Access** Sets the minimum access level (Logged off, Operator, Supervisor, Engineer) for loading programs, and for allowing edits to the current program including permission to advance a segment.

Prog Store Access	Sets the minimum access level (Logged off, Operator, Supervisor, Engineer) that allows users to copy, store and delete programs.
Rate Resolution	Sets the resolution (0 to 4 decimal places) of ramp rates when read from / written to via scaled integer comms.
Ch1 Units	Five-character (max.) descriptor for channel 1 units. If wired, the units will be those of the wire source.
Ch1 Resolution	Number of decimal places for channel 1 value. If wired, the value will be that of the wire source.
Ch1 Servo To	Determines whether the programmer starts running channel 1 from the control loop's configured set-point (servo to SP), or from the current process value (servo to PV).
Ch1 PV Input	Various programmer functions (for example Ch1 Servo to PV), require the PV value of the loop that the programmer is trying to control. The parameter is normally wired from the loop's Track PV parameter.
Ch1 SP Input	Various programmer functions (for example Ch1 Servo to SP), require the SP value of the loop that the programmer is trying to control - it is normally wired from the loop's Track SP parameter.
Ch2 Units	As 'Ch1 Units', above but for channel 2. Appears only if 'Channels' is set to '2'.
Ch2 Resolution	As 'Ch1 Resolution', above, but for channel 2. Appears only if 'Channels' is set to '2'.
Ch2 Servo To	As 'Ch1 Servo To', above, but for channel 2. Appears only if 'Channels' is set to '2'.
Ch2 PV Input	As 'Ch1 PV Input', above, but for channel 2. Appears only if 'Channels' is set to '2'.
Ch1 SP Input	As 'Ch1 SP Input', above, but for channel 2. Appears only if 'Channels' is set to '2'.
Power Fail Action	If the power supplied to the instrument is interrupted, the program status is retained and when power is restored, the instrument performs the selected power fail action. Continue: The programmer set-point returns immediately to its last value prior to the power down and the program continues to run from that point. Reset: The program resets. Ramp Back: The programmer servos the programmer set-point to the channel PV, and ramps to the target set-point at the rate prior to the power-fail. The time remaining for the segment is recalculated.

Notes:

1. If the interrupted segment was a 'time to target' ramp, then when power is returned the calculated ramp rate prior to the interruption is used.
2. If the interrupted segment was 'Dwell', then the ramp rate is determined by the previous ramp segment. On achieving the dwell set-point, the dwell period continues.
3. If a previous ramp segment does not exist (i.e. the first segment of a program is a dwell), the dwell continues at the 'servo to PV' programmer set-point.

Max Events	Configures the maximum number of event outputs (0 to 8).
Reset Event N	Sets the state of event output 'N' when the program is in reset. Appears only if 'Max Events' is > (N-1).
Reset Ch1 UV	Enter the value to be written to user value 1 when the program is in reset. Appears only if 'User Value' feature is enabled in Programmer.Features configuration ("Programmer Features menu" on page 172).

Reset Ch2 UV	Enter the value to be written to user value 2 when the program is in reset. Appears only if 'User Value' feature is enabled in Programmer.Features configuration ("Programmer Features menu" on page 172) and 'Channels' = '2'.
Run	The input that causes the programmer to place the current program in Run mode.
Hold	The input that causes the programmer to place the current program in Hold mode.
Reset	The input that causes the programmer to place the current program in Reset mode.
Run Reset	Dual functionality input, that causes the programmer to place the current program in Run or Reset mode.
Run Hold	Dual functionality input, that causes the programmer to place the current program in Run or Hold mode.
Wait Digital	The Boolean input that is used in Wait segments.
Wait Analog 1	The analogue input associated with channel 1 that is used in wait segments.
Wait Analog 2	The analogue input associated with channel 2 that is used in wait segments. Appears only if 'Channels' = '2'.
Advance Operation	The input to advance the current segment. Program file operation selection parameter. See 'Program editing' ("Programmer Display Mode" on page 59) for further details.
Status	Status indication of the selected file operation. See 'Program editing' ("Programmer Display Mode" on page 59) for further details.
Amended	Indicates whether the current program has been amended since being loaded (Comms only)
File Error Status	File operation error status (Busy, OK, Load Open File Error, Store Open File Error, Delete File Fail, Copy File Fail, Invalid Format, Invalid Device, Invalid Version, Invalid Num Channels, Parameter Write Fail, Store Operation Did Not Complete, Load Operation Did Not Complete, Delete Operation Did Not Complete, Copy Operation Did Not Complete, Invalid Filename, Unspecified Error). Available only over Comms as the error is displayed on the display screen. 'Parameter Write Fail' indicates that one or more program/segment parameters failed to be written to during a 'Load' operation. This is generally caused by a program that contains features (i.e. Holdback, User Values, PV Events) which are disabled in the instrument's Programmer block, or the program contains more Event Outputs than configured in the instrument's Programmer block.
Program Num	A program name may be prefixed by a program number from 1 to 99. This is necessary if a program is to be loaded either using a BCD switch or via a single comms transaction. The parameter shows the last program to be loaded via the program number. See also "Programmer Display Mode" on page 59. 'Program Load Via a Program Number'.

Programmer Run menu

Programmer.Run	
Mode	Run
Status	Running
Ch1 PSP	43.3 V
Ch2 PSP	42.9 V
Segment	Heat Init
Segment Type	Ramp
Segment Time Left	00:00:33
Segment Time Run	00:01:17
Prog Time Left	00:18:48
Prog Time Spent	00:00:33
Prog Time Run	00:00:53
Duration	00:00:14
Ch1 TSP	43.3 V
Ch1 Time	00:01:00
Ch2 TSP	10.5 V
Ch2 Time	00:02:23
Cycles Left	10
Ch1 User Val	7
Ch2 User Val	3
Ch1 PV Event	<input type="checkbox"/>
Ch2 PV Event	<input type="checkbox"/>
Event 1	<input checked="" type="checkbox"/>
Event 2	<input type="checkbox"/>
End Output	<input type="checkbox"/>

Figure 118 Programmer.Run

Mode	Current program mode (Run, Hold, Reset).
Status	Current program status (Running, Holding, Holdback, Waiting, Reset, Complete)
Ch1 PSP	The output setpoint for channel 1.
Ch2 PSP	The output setpoint for channel 2. Appears only if 'Channels' = '2' in the Set Up menu ("Programmer Setup menu" on page 175).
Segment	Name of the current segment as entered in the Program Edit page ("Programmer Display Mode" on page 59).
Segment Type	Current segment type as entered in the Program Edit page ("Programmer Display Mode" on page 59).
Seg Time Left	Indicates the minimum amount of time left in the current segment.
Seg Time Run	The length of time that the current segment has been running. This value does not include time spent in Hold, Holdback or Waiting.
Prog Time Left	Shows the minimum amount of time left before the program completes. Each segment can be up to 500 hours in length. The maximum display is 500 hours, and if the

	remains at 500 until the remaining time falls below 500 hours.
Prog Time Spent	Indicates the length of time the current program has been running, including time spent in Hold, Holdback or Waiting.
Prog Time Run	The length of time the current program has been running. This value does not include time spent in Hold, Holdback or Waiting
Duration	For Dwell segments only, this is the dwell duration.
Ch1 TSP	For Ramp and Step segments, this is the current target setpoint for channel 1.
Ch1 Time	For Ramp segments, this is the configured time for channel 1 to reach its Target Setpoint (TSP).
Ch2 TSP	For Ramp and Step segments, this is the current target setpoint for channel 2. Appears only if 'Channels' = '2' in the Programmer Set Up menu ("Programmer Setup menu" on page 175).
Ch2 Time	For Ramp segments, this is the configured time for channel 2 to reach its Target Setpoint (TSP). Appears only if 'Channels' = '2' in the Programmer Set Up menu ("Programmer Setup menu" on page 175)
Cycles Left	The number of Go Back cycles remaining before the Go Back loop ends.
Ch1 User Val	The value of user value 1 in the current segment. Appears only if the 'User Value' feature is enabled in the Programmer Features menu ("Programmer Features menu" on page 172).
Ch2 User Val	The value of user value 2 in the current segment. Appears only if the 'User Value' feature is enabled in the Programmer Features menu ("Programmer Features menu" on page 172) and if 'Channels' = '2' in the Programmer Set Up menu ("Programmer Setup menu" on page 175).
Ch1 PV Event	The state of channel 1 PV event (Off = Cross symbol, On = Tick). Appears only if the 'PV Event' feature is enabled.
Ch2 PV Event	The state of channel 2 PV event (Off = Cross symbol, On = Tick). Appears only if the 'PV Event' feature is enabled and if 'Channels' = '2' in the Programmer Set Up menu ("Programmer Setup menu" on page 175).
Event 1 to 8	The state of event output 1 to 8 for the current segment (Off = Cross symbol, On = Tick). The number of events appearing is defined in the Programmer Set Up menu ("Programmer Setup menu" on page 175) (Max Events).
End Output	The output that is set by the end segment (Off = Cross symbol, On = Tick).

Connecting the programmer to a loop

Below are some examples of how programmers and loops may be soft-wired together so that the programmer has access to the Loop PV and Loop setpoint. The examples are taken from iTools (Section 9), but may be carried out through User Wiring ("User Wiring") if more convenient.

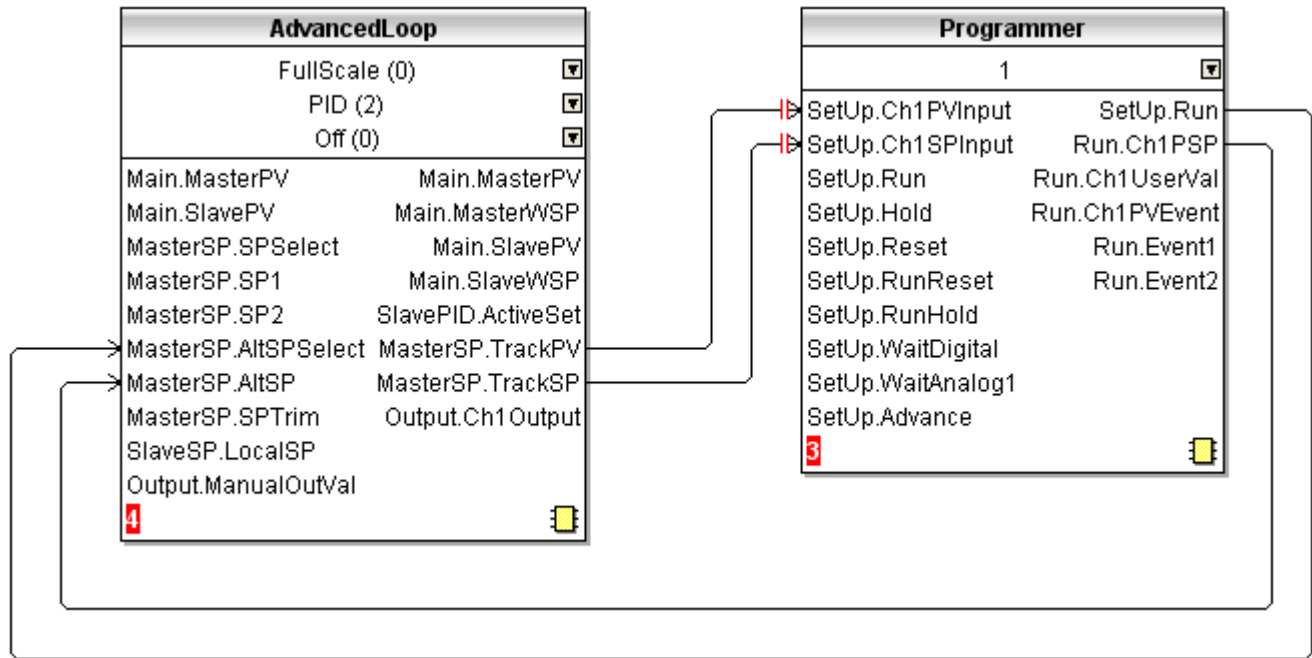

Figure 119 Advanced loop to Programmer basic wiring

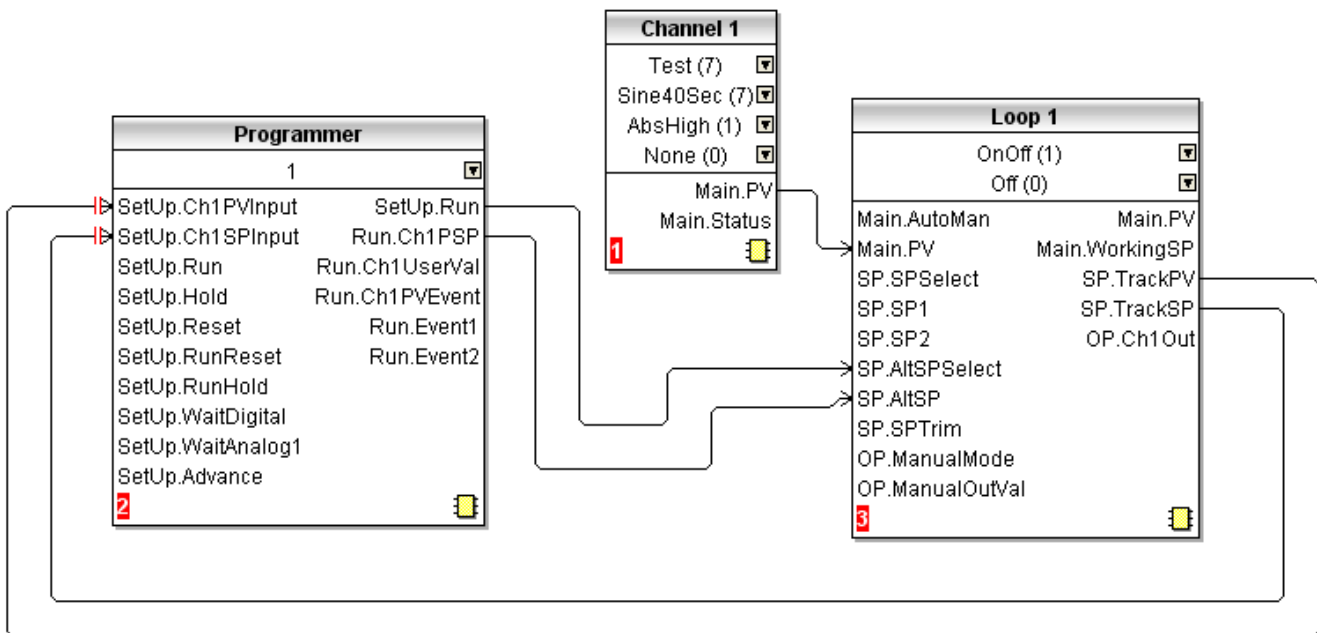

Figure 120 Programmer to Loop basic wiring

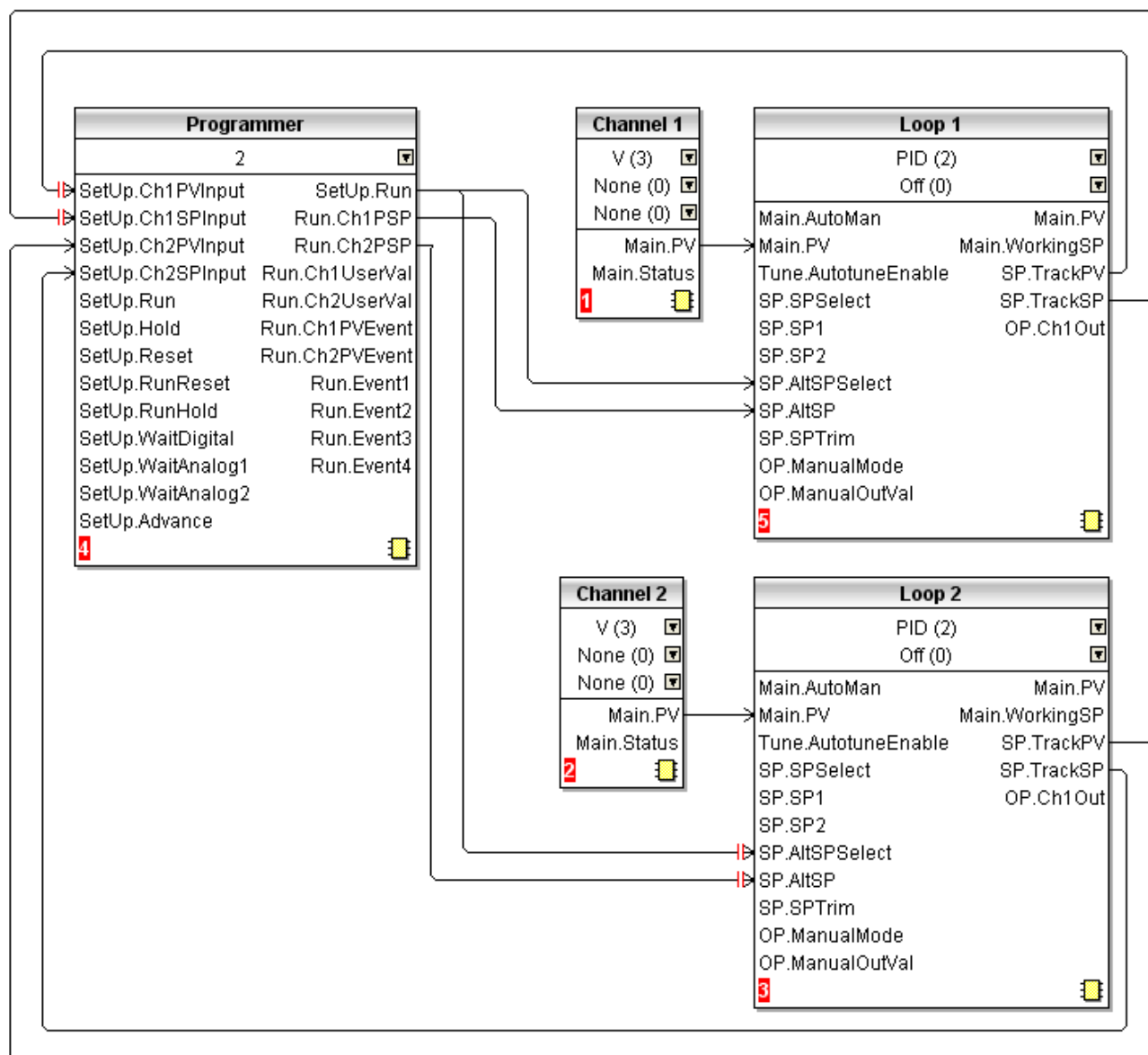

Figure 121 Dual programmer to two loops basic wiring

Configuration by Modbus Comms

It is possible to configure, store, delete, or load a program via Modbus comms by setting the Program and Segment parameters using either their scaled integer or native Modbus addresses ("Parameter List" on page 232).

Example 1: Configure a Program

To configure a simple Ramp-Dwell-Ramp program via Modbus comms:

- Set Segment.1.Type (address 15040) to Ramp (1)
- Set Segment.1.Ch1TSP (address 15042) to 60.0 (600 -1dp)
- Set Segment.1.Ch1Time (address 15044) to 60s (60s)
- Set Segment.2.Type (address 15088) to Dwell (2)
- Set Segment.2.Duration (address 15089) to 120s (120)
- Set Segment.3.Type (address 15136) to Ramp (1)
- Set Segment.3.Ch1TSP (address 15138) to 0.0 (0 -1dp)
- Set Segment.3.Ch1Time (address 15140) to 180s (180)

Example 2: Store a Program

To store the current program:

Set Programmer.FileList.FileNameEntry (address 27281) to required filename (e.g. George)

Set Programmer.Setup.Operation (address 14912) to Store (4)

Read Programmer.Setup.Operation (address 14912) until it returns Select (1)

Read Programmer.Setup.Status (address 14913) to get the status of the store operation (Success = 1, Failed = 2)

Example 3: List Stored Programs

To get a listing of stored program files:

Set Programmer.FileList.Operation (address 14976) to Get Listing (1)

Read Programmer.FileList.Operation (address 14976) until it returns Complete (0)

Read Programmer.FileList.FileName1 to 100 parameters (address 30976 - 31075)

Note: For each filename parameter perform a 21 register block read starting from the base address of the parameter, 1st null string indicates end of List.

Example 4: Loading Programs

To load a program:

Get a listing as described above

Set Programmer.FileList.FileNameEntry (address 27281) to the filename to be loaded (e.g. George)

Set Programmer.Setup.Operation (address 14912) to Load (2)

Read Programmer.Setup.Operation (address 14912) until it returns Select (1)

Read Programmer.Setup.Status (address 14913) to get the status of the load operation (Success = 1, Failed = 2).

Example 5: Loading a Program via a Program Number

Set Programmer.Setup.ProgNum (address 14920) to the program number to be loaded.

Modbus Master Configuration

Modbus master configuration is divided into two areas: a) setting up the slave(s), including diagnostics, and b) defining the locations of the parameters to be read. [Figure 122](#) shows an overview. "Modbus Master display mode" on page 78 shows the Modbus Master display page, and describes the configuration options available there.

Note: Versions 2.40 to 2.50 of the Mini8 Controller, and versions 2.70 to 3.20 of the Model 3550 controller are supported. It is not guaranteed that later software versions of these instruments will be fully compatible.

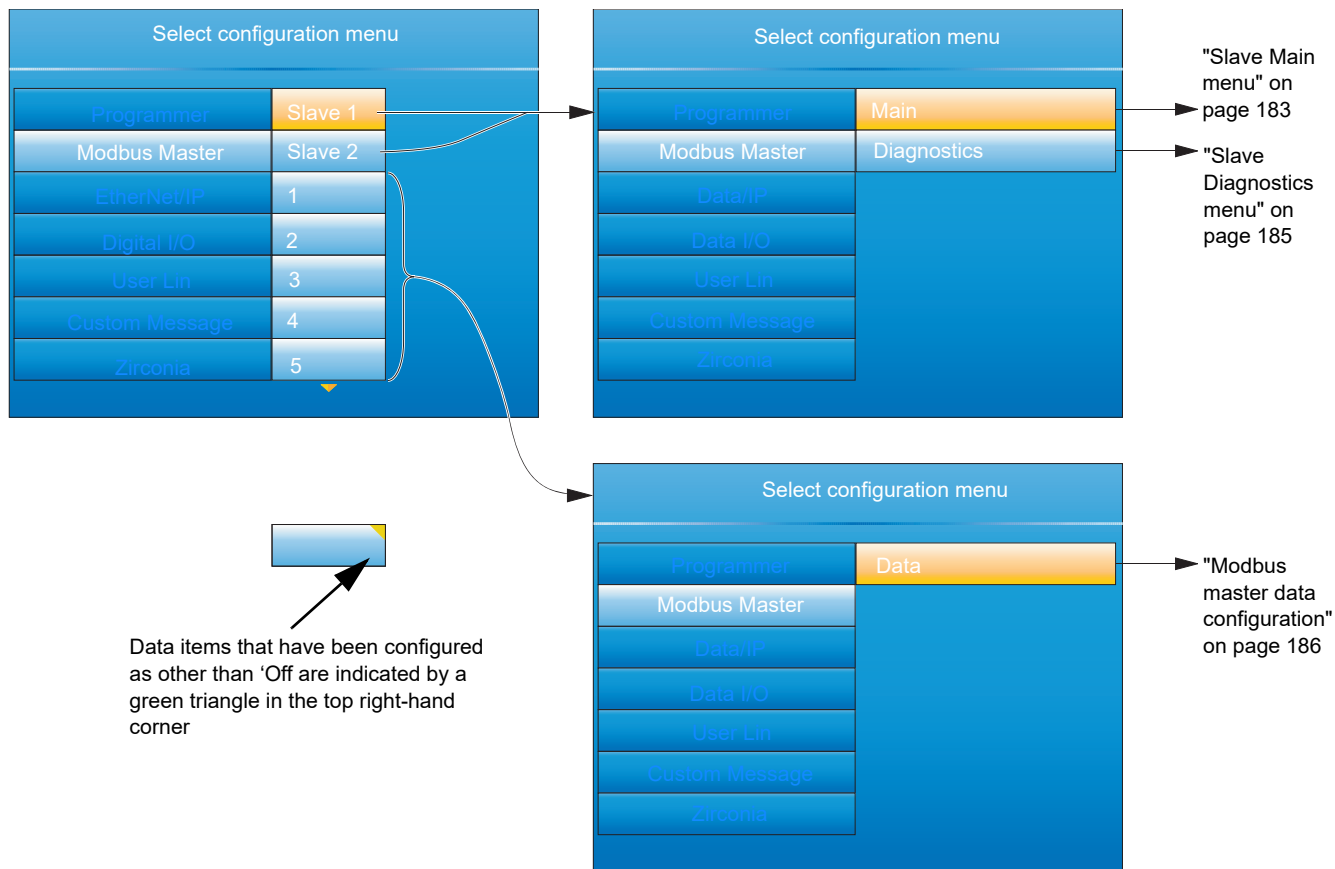

Figure 122 Modbus Master configuration top level menus

Slave Main menu

This allows the IP address, Unit ID and other communications parameters to be entered for Slaves 1 and 2.

The screenshot shows the configuration screen for 'Modbus Master.Slave.1.Main'. The 'Descriptor' is 'nanodac'. The 'Online' status is checked. Other parameters include 'Comms Failure' (No), 'IP Address' (123.123.123.111), 'Unit ID' (1), 'Search Device' (No), 'Search Result' (Available), 'Profile' (nanodac), 'Retries' (3), 'Timeout (ms)' (250), 'Max Block Size' (124), and priority settings for High (0.125 sec), Medium (1 sec), and Low (2 secs).

Available Priority selections table:

Seconds	Minutes	Hours
0.125	1	1
0.25	2	
0.5	5	
1	10	
2	20	
5	30	
10		
20		
30		

Figure 123 Modbus Master Slave 1 configuration (Slave 2 similar)

Descriptor	A descriptor for this instrument. For use in Modbus communications, this is not the same as the 'Name' which appears in the Instrument Info configuration ("Custom Messages" on page 198).
Online	Disabled by default (Cross symbol). Must be enabled (highlighted using the down arrow, then edited by the scroll button) to allow the remaining configuration items to appear and to allow data transactions be processed. Setting the slave offline temporarily disables data transactions - it does not reconfigure them.
Comms Failure	Active (yes) if a data item has failed to respond after all retries.
IP Address	The IP address of the Slave device.
Unit ID	The Unit Id or Modbus address to use in each data transaction with the slave device. Limits are 1 to 255.
Search Device	Setting this to 'Yes' searches the network to see if the device with the specified IP address and Unit ID is available. If so, the descriptor will be overwritten to indicate what type of device has been found.
Search Result	The status of the selected 'Search Device' request (Searching, Available, Unreachable). Search activity is indicated by a rotating animated display in the 'Searching' field.
Profile	A number of profiles are held within the instrument that match a selection of known devices. If the device is 'known', its type, model number etc. is displayed. If the device is unknown, '3rd Party' appears instead.
Retries	The number of times (0 to 3) to re-send a data transaction to the device if no response is received within the configured timeout period (below).
Timeout	The timeout period for each Modbus transaction in ms.
Max Block Size	The maximum number of registers (16bit words) that a single data transaction is permitted to contain.
High Priority	The interval rate between each high priority data transaction. Default = 0.125 second.
Medium Priority	The interval rate between each medium priority data transaction. Default = 1 second.
Low Priority	The interval rate between each low priority data transaction. Default = 2 seconds.

Priority Levels

Three levels of update rate can be entered for use in data configuration ("Modbus master data configuration" on page 186), to define how often a value is read or written. In order to optimise performance, it is recommended that the slowest rate consistent with requirements be selected. The intervals are selected from a scroll list see [Figure 123](#) above.

Slave Diagnostics menu

Modbus Master.Slave.1.Diagnostics	
Actual High	0.125
Actual Medium	1.000
Actual Low	2.000
Device Status	Success
Loopback Test	15428
Total	15428
Successful	0
Failures	0
Retries	0
Timeouts	0
Illegal Function	0
illegal Address	0
Illegal Data	0
Slave Failure	0
No Gateway Path	0
Reset	No

Figure 124 Diagnostics menu

Note: Diagnostic values are reset on power up.

Actual High	The high priority rate that this slave is actually running at. This can never be faster than the high priority rate that was configured for this device (Slave Main menu, above), but if the master is heavily loaded the rate may be lower than that specified.
Actual Medium	The medium priority rate that this slave is running at. This can never be faster than the medium priority rate that was configured for this device (Slave Main menu, above), but if the master is heavily loaded the rate may be lower than that specified.
Actual Low	The actual low priority rate that this slave is running at. This can never be faster than the low priority rate that was configured for this device (Slave Main menu, above), but if the master is heavily loaded the rate may be lower than that specified.
Device Status	The status of the last transaction to this slave. Success: The transaction was successfully actioned by the slave device. Timeout: There was no response from the slave device to a given request within the configured time. Illegal Address: The request to the slave device contained an invalid Modbus address. The address may be for a read only parameter. Illegal Value: The request to the slave device contained invalid data for the specified parameter. Bad Sub: The sub function code in the request was invalid. Idle: This data item is currently idle and not communicating with the slave device. Illegal Code: The slave does not support the function code transmitted by the master.

	cause being that the slave device has not been set to on-line.
Loopback Test	If set to 'Yes', Sends a function code 8 transaction to the slave, and waits for a response.
Total	A count of all the transactions sent to the slave including reads, writes both good and failed transactions.
Successful	A count of all the successful transactions sent to the slave.
Failures	A count of all the unsuccessful (failed) transactions sent to the slave. May be caused by Illegal Function, Illegal Address etc. failures, as detailed below.
Retries	The number of transactions that were re-sent because of timed out responses from the slave devices.
Timeouts	A count of all the transactions sent to the slave for which no response was received within the configured timeout period.
Illegal Function	A count of all the transactions sent to the slave that the slave claimed contained an invalid function code. Exception code (1).
Illegal Address	A count of all the transactions sent to the slave that the slave claimed contained an invalid Modbus register address. Exception code (2).
Illegal Data	A count of all the transactions sent to the slave that the slave claimed contained an invalid value. Exception code (3).
Slave Failure	A count of all the times this slave device has failed to communicate. Exception code (4).
No Gateway Path	A count of all the times it has not been possible to access the slave device as it is on another network that requires a gateway for access.
Master Rejects	A count of all the transactions that the Modbus Master has refused to send to the slave due to invalid configuration data.
Reset	A one shot action that immediately resets all diagnostics counts.

Modbus master data configuration

This is the area of configuration in which the individual data items are selected for transmission across the Modbus master communications link. The configuration fields that appear depends on the parameter selected, so the examples given here will probably not match those that appear to the user. The parameters that appear in the 'Parameter List' scroll menu depends on the slave model.

Example 1: Target SP1 with Nanodac Slave

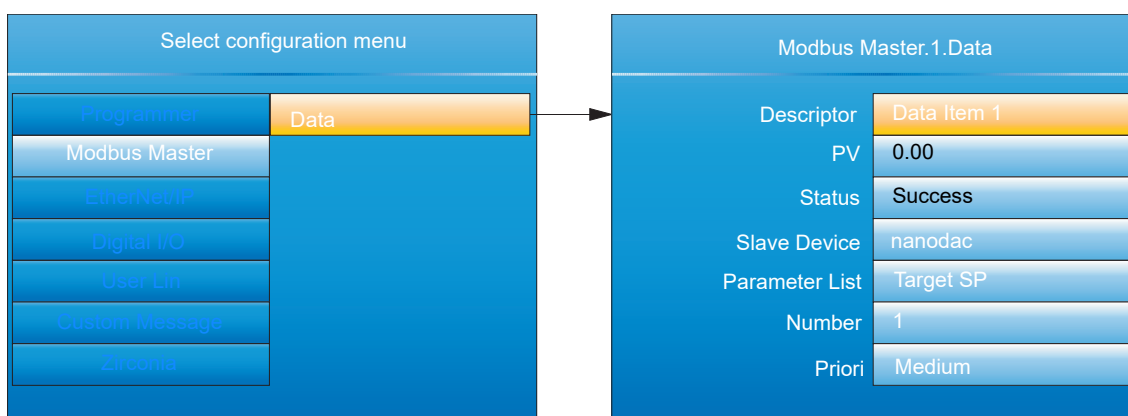

Figure 125 Target Setpoint

Example 2 User Defined Parameter

This allows the user to enter a Modbus address (decimal) and a data type in order to read the value of a parameter from or write a parameter value to the slave. Modbus address and data types must be obtained from the documentation supplied with the slave device. For convenience, this example uses a nanodac as the slave; the table in "Parameter List" on page 232 of this document providing the required data.

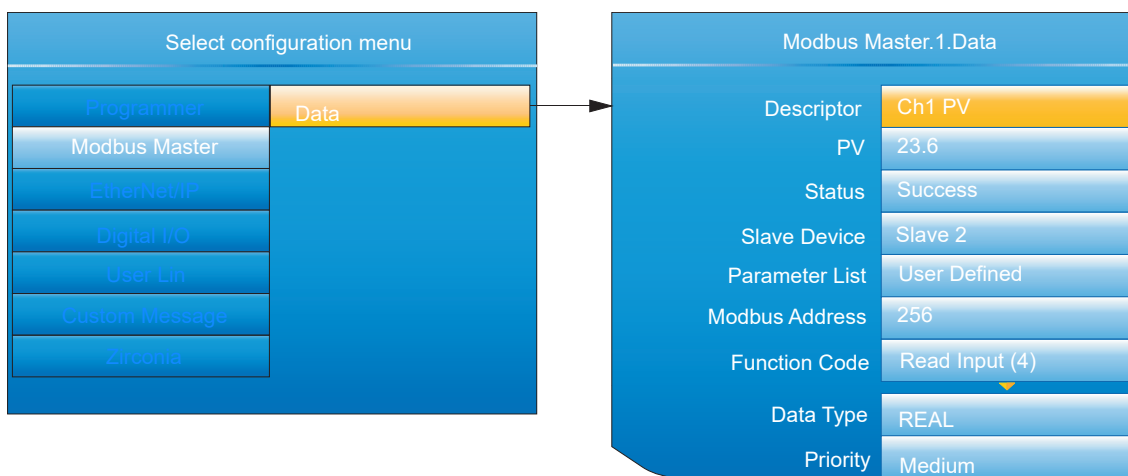

Figure 126 User defined parameters

DATA PARAMETERS

This lists all possible configuration fields that might appear, not just those shown in the examples above.

Descriptor	Up to 20 characters used to describe the current data item (used in the Modbus Master user page ("Modbus Master display mode" on page 78)).
PV	The process value currently being read from the selected slave. Visible only if data item is not an alarm type. The value must be wired to a virtual channel with 'Operation' = 'Copy' if it is to be trended and/or recorded.
Sys Alm status	The status (e.g. None, Active) of the data item. Visible only for specific read profiles. The value must be wired to a virtual channel with 'Operation' = 'Copy' if it is to be trended and/or recorded.

Chan. Alm Status	The status of the data item. Visible only for specific read profiles. The value must be wired to a virtual channel with 'Operation' = 'Copy' if it is to be trended and/or recorded.
Set	Allows the user to set an on/off value. Visible only for specific write profiles.
Mode	Allows the user to set an auto/manual value. Visible only for specific write profiles.
Value	Configured or wired value to be sent to the selected slave. This parameter is available only with function codes 6 & 16.
Fall Back Value	The value to be sent to the selected slave if the 'Value' parameter is wired and has a status other than GOOD_PV. This parameter is available only with function codes 6 & 16 It is not possible to wire Fall Back Value from another parameter and it can be configured only manually.
Send	A one shot action that sends the data in the 'Value' parameter or the 'Fall Back Value' parameter (depending upon the status of 'Value') to the selected slave. This is classed as an acyclic write and so is available only for function codes 6 & 16. The 'Priority' parameter must be set to 'Acyclic'.
Status	<p>The status of the last transaction sent to the selected slave.</p> <p>Success: The transaction was successfully actioned by the slave device.</p> <p>Timeout: There was no response from the slave device to a given request within the configured time.</p> <p>Illegal Address: The request to the slave device contained an invalid Modbus address. The address may be for a read only parameter.</p> <p>Illegal Value: The request to the slave device contained invalid data for the specified parameter.</p> <p>Bad Sub: The sub function code in the request was invalid.</p> <p>Idle: This data item is currently idle and not communicating with the slave device</p> <p>Illegal Code: The slave does not support the function code transmitted by the master.</p> <p>Pending: The request is waiting to be sent, the most likely cause being that the slave device has not been set to on-line.</p>
Slave Device	A list of available slaves that this data is to communicate with.
Parameter List	List of parameters available for the selected slave devices profile. These parameters require no user configuration.
Number	The channel, loop or group etc. instance.
Modbus Address	The Modbus register address that this data is to be read or written to. Limits are 0 - 65535.
Function Code	The function code to use, this determines if the data is going to be read or written to the selected slave. Supported function codes are:

Code	Description	Code	Description
1	Read contiguous status coils	5	Write a single coil on or off
2	Read contiguous discrete inputs	6	Write to a single register
3	Read contiguous holding registers	8	Loopback test
4	Read contiguous input registers	16	Write to contiguous registers

Data Type	<p>The data type that defines how this data is going to be represented. The data types listed below are supported.</p> <p>8-bit signed byte (BYTE) 8-bit unsigned byte (UBYTE) 16-bit signed integer (INT) 16-bit unsigned integer (UINT) 32-bit signed long (DINT) 32-bit unsigned long (UDINT) 32-bit floating point IEEE (REAL) 32-bit signed long (little Endian, word swapped) (DINT (Swap)) 32-bit unsigned long (little Endian, word swapped) (UDINT (Swap)) 32-bit floating point IEEE (little Endian, word swapped) (REAL (swap)) Bit from register (BIT)</p> <p>By default all 16 & 32 bit data types (unless specified) will be transmitted in Big Endian format, where the most significant byte in the value is sent first. Byte Ordering: (for big Endian) (0x12 sent first) 16-bit 0x1234 0x12, 0x34 32-bit 0x12345678 0x12, 0x34, 0x56, 0x78</p>
Bit Position	The bit in the register to be extracted, this is only available if the 'Data Type' selected is 'BIT In Register'.
Scaling	The decimal placing for scaled 16 bit data types. Visible depending on the 'Data Type' selected.
Priority	The frequency with which this data will be managed. See ' Priority Levels ', in "Slave Main menu" on page 183, above.

Ethernet/IP Configuration

This area of configuration allows the 'Client' user to set up an EtherNet/IP communications link with up to two Server units. The 'Server' user has a more limited range of configurable items.

Note: Implicit I/O is used for continuous real-time transfer of multiple data items from instrument to instrument. Explicit I/O is used as a 'one-shot' transfer of a single data item. See "EtherNet/IP display mode" on page 80 for further details. [Figure 127](#) shows that the configuration is split into three areas: Main, Implicit Inputs and Implicit Outputs, but it should be noted that the implicit inputs and implicit outputs are read only, as these can be configured only by using iTools, as described in the EtherNet/IP display mode description ("EtherNet/IP display mode" on page 80).

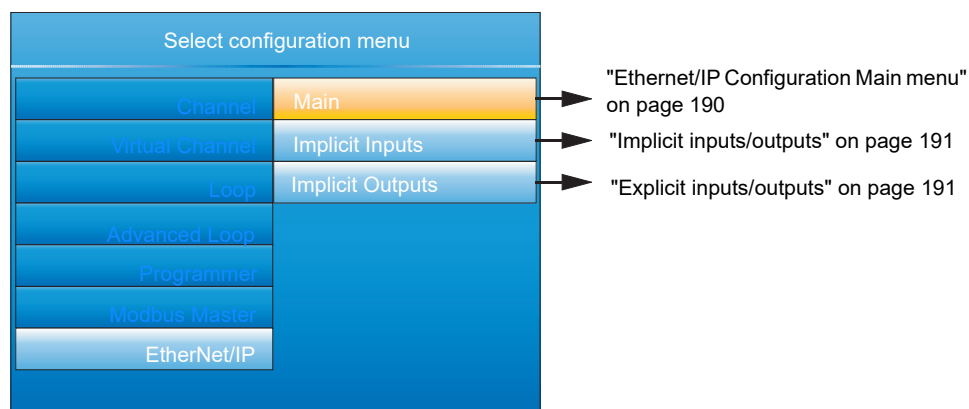

Figure 127 Client configuration

Ethernet/IP Configuration Main menu

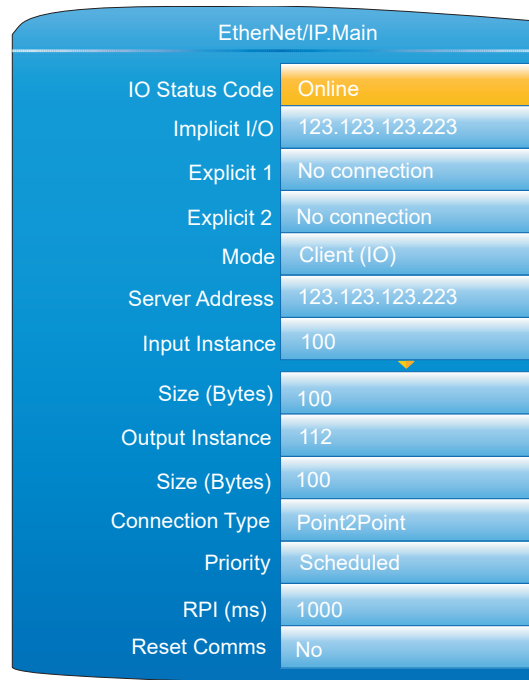

Figure 128 Ethernet/IP Main menu

Net Status Code	<p>Network status (Server only)</p> <p>Offline: nanodac online but there are currently no CIP connections</p> <p>Online: nanodac online with at least 1 CIP connection</p> <p>Connection Timeout: The connection has timed out</p> <p>Duplicate IP: A duplicate IP address has been detected on the network</p> <p>Initialisation: nanodac is initialising comms</p>
IO Status Code	IO status (Client (IO) only). As above.
Tag Status code	Tag status (Client (Tags) only). See Figure 129 , below.
Implicit I/O	Connected IO server IP address.
Multicast	Connected IO server IP address (only if multicast selected).
Explicit 1	Connected client/server IP address.
Explicit 2	Connected client/server IP address.
Mode	Modes of operation: Server, Client (IO) or Client (Tags).
Server Address	IO Server IP address (Client mode only).
Input Instance	Input class instance number (client mode only).
Size (bytes)	The size in bytes of data that the client is expecting to read from the implicit input.
Output Instance	Output class instance number (client mode only).
Size (bytes)	The size of data that the client is expecting to write to the server.
Connection Type	Connection type (client mode only).
Priority	Connection priority (client mode only).
Rpi	IO connection speed (client mode only).
Reset Comms	Applies all changes to the EtherNet/IP stack at the same time. Or can be used to reset communications using the current configuration.
Slot Number	PLC slot number (zero indexed) when communicating using tags.

Implicit inputs/outputs

This display provides a read-only display of the values in the input and output data tables. Parameters are placed in the input and output tables using the proprietary software tool called 'iTools', as described in "EtherNet/IP display mode" on page 80.

Explicit inputs/outputs

See "EtherNet/IP display mode" on page 80 for details.

0	Success. Service was successful
1	Connection Failed. A connection in the path failed
2	Invalid Parameter. A parameter associated with the request was invalid
3	Memory Unavailable. No available resources in the server to service the request
4	Path Segment Error. The syntax of all or some of the path was not understood
5	Path Dest. Error. The path references an unknown object, class or instance
6	Partial Transfer. Only part of the expected data was transferred
7	Connection Lost. The messaging connection was lost
8	Service Unsupported. Undefined service for requested object
9	Invalid Attribute. Invalid attribute data detected
10	Attribute Error. An attribute in the response has a non zero status
11	Already Requested. The object is already in the mode/state being requested
12	Object Conflict. The object cannot perform the requested service
13	Already Exists. The requested instance or object already exists
14	Attribute Error. Request to modify a non modifiable attribute received
15	No Privileges. Permission/Privilege check failed
16	State Conflict. The current state or mode prohibits the execution of the requested service
17	Reply To Large. Response buffer too small for response data
18	Fragmented Value. For example this service request will return only half a REAL data type
19	Not Enough Data. The service does not provide enough data to complete the request
20	Invalid Attribute. Requested attribute is not supported
21	Too Much Data. The service supplied more than was expected
22	Object Non-Exist. The object specified does not exist in the device
23	Seq. Fragmentation. The fragmentation sequence for this service is not active
24	No Attribute Data. The attribute data for this object was not saved at the server prior to this request service
25	Data Store Failure. The attribute data for this object was not saved due to a failure during the attempt
26	Routing Failed. The service request packet was too large for transmission on a network in the path to the destination. The routing device was forced to abort the service
27	Routing Failed. The service request packet was too large for transmission on a network in the path to the destination. The routing device was forced to abort the service
28	Missing Attribute. The service did not supply an attribute in a list of attributes that was needed by the service to perform the requested behaviour

29	Invalid Attribute. The service is returning the list of attributes supplied with status information for those attributes that were invalid
30	Embedded Tag Error. An embedded service resulted in an error. This is most commonly an incorrectly formatted tag name
31	Vendor Error. A vendor specific error has encountered
32	Invalid Parameter. A parameter associated with the request was invalid
33	Write Once Error. An attempt to write to a write once only parameter occurred
34	Invalid Reply. An invalid reply was received
35	Buffer Overflow. The message received is larger than the receiving buffer
36	Format Error. The format of the received message is not supported
37	Key Path Failure. The key segment in the path does not match destination key
38	Path Size Error. The size of the path in the request is too large
39	Unexpected Attribute. Unable to set the attribute at this time
40	Invalid Member Id. The requested member id does not match class object
41	Member Is R/O. A request to modify a R/O member was received
42	Group 2 Server. Group 2 DeviceNet server response
43	Translation Error. A CIP Modbus translator request failed
44	Attribute Is R/O. A request to read a non readable attribute was received
64	No Tags Found. There were no tags configured in the input or output tables
65	Invalid Config. The total length in characters of all the tags in this table will cause the PLC to exceed its internal buffer of 500 bytes. To eliminate this problem, reduce the length of some or all tag names

Figure 129 Tag Status code definition

Web Server

Note: By default the Web Server will be enabled to use HTTPS.

The Web Server has been added from firmware versions V5.00 onwards and provides the following features:

- Up to four unique client connections
- PC, Tablet and mobile phone client support (using appropriate browsers)
- Full URL translation support
- Runtime data
- Historical data
- Target information
- Alarm information
- Message log
- Promote page
- Full cookie support
- Safari, IE9 or greater and Google Chrome browser support

The web server provides visualisation only.

Configuration Display

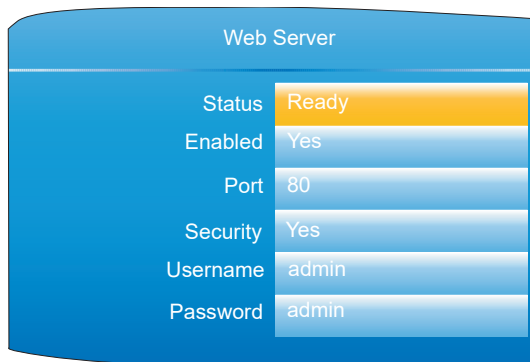

Figure 130 Web server configuration page

Status	Read only. Ready - the web server is running. Inactive -the web server is not ready Connected - the web server is connected. It is possible that Status will flip between Ready and Connected during operation.
Enabled	Yes/No
Port	80 or 8080
Security	Yes/No. Yes is the default.
Username	Enter a customised user name. This will be required when logging in to the webserver. Default is 'admin'. Username is only shown when 'Security' is set to 'Yes'.
Password	Enter a customised password. This will be required when logging in to the webserver. Password is only shown when 'Security' is set to 'Yes'

For further information regarding Web Server pages, see [Appendix D: Web Server \(page 439\)](#).

Digital I/O

This area of configuration allows the digital I/O types to be selected.

Notes:

1. If 2A2B is set to 'Valve Raise', then 3A3B is set to 'Valve Lower'. Similarly, if relay 4AC is set to 'Valve Raise', then relay 5AC is set to 'Valve Lower'. When the loop channel output is wired to the PV input of a Valve Raise function, then the PV input of the associated Valve Lower function becomes unavailable for wiring, and both outputs are controlled by the loop as a pair, using only the single wire.
2. See "Time Proportioning" on page 430 for a description of time proportioning.

Select configuration menu : Note: These fields do not appear if they contain I/O type 'DC Output'.

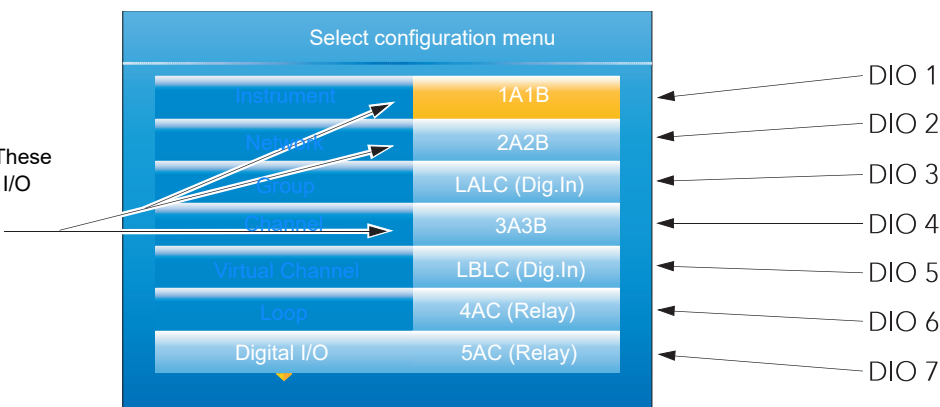

Figure 131 Digital I/O top level menu

Digital input/output

This applies to signals at terminals 1A/1B (Figure 4). Highlight '1A1B', then operate the scroll key to reveal the configuration menu.

Module Ident	Dig IO
Type	On Off O/P, Time Prop O/P or Contact I/P (default)
PV	For inputs, 0 = contact is open; 1 = contact is closed. For On Off O/P, a value = 0.5 drives the output high, otherwise, the output is driven low. For Time Prop O/P, the value is the demanded output percentage.
Min On Time	For Type = Time Prop O/P only, this allows a minimum on time to be specified. Configurable range = 0.1 to 150 seconds
Invert	Inverts the output sense for digital outputs; or the input signal for digital inputs.
Output	Off = output being driven low; On = output being driven high. Does not appear for Type = Contact I/P

Relay outputs

This may apply to terminal pairs 1A1B, 2A2B, 3A3B, 4AC, 5AC (Figure 4). Highlight the relevant terminal pair, then operate the scroll key to reveal the configuration menu.

Module Ident	Relay.
Type (2A2B, 4AC)	On Off O/P (default), Time Prop O/P, Valve Raise (not if DC output I/O fitted).
Type (3A3B, 5AC)	'On Off O/P' (default), 'Time Prop O/P'. The 3A3B relay is not fitted if 'DC Output' I/O is fitted (see "Configuration Display" on page 193).
PV	For On Off O/P, a value = 0.5 closes the relay contacts, otherwise, the contacts are open. For Time Prop O/P, the value is the demanded output percentage.
Min On Time	For Type = Time Prop O/P only, this allows a minimum on time to be specified to reduce relay wear. Configurable range = 0.1 to 150 seconds.
Invert	Inverts the output sense for the relays (not applicable if Type = Valve Raise).
Inertia	For Type = Valve Raise only, this allows a value to be entered (in seconds) to take into account valve run-on.
Backlash	For Type = Valve Raise only, this allows a value to be entered (in seconds) in order to compensate for backlash in the valve linkage.
Standby action	For Type = Valve Raise only, this specifies the valve action when the instrument is in standby mode. Continue: Output continues at the demanded level. Freeze: The valve stops being driven.
Output	Off = relay contacts open; On = relay contacts closed.

Digital inputs

This applies to terminals pairs LALC, LBLC (Figure 4). Highlight the relevant terminal pair, then operate the scroll key to reveal the configuration menu.

Module Ident	Dig.In
Type	Contact I/P
PV	0 = contact is open; 1 = contact is closed.

Digital outputs

This applies to terminal pair 2A2B (Figure 4). Highlight 2A2B, then operate the scroll key to reveal the configuration menu.

Module Ident	Dig.Out
Type	On Off O/P, Time Prop O/P or Valve Raise
PV	For On Off O/P, a value = 0.5 drives the output high, otherwise, the output is driven low. For Time Prop O/P, the value is the demanded output percentage.
Min On Time	For Type = Time Prop O/P only, this allows a minimum on time to be specified. Configurable range = 0.1 to 150 seconds
Invert	Inverts the output sense for digital outputs; or the input signal for digital inputs.
Inertia	For Type = Valve Raise only, this allows a value to be entered (in seconds) to take into account valve run-on.
Backlash	For Type = Valve Raise only, this allows a value to be entered (in seconds) in order to compensate for backlash in the valve linkage.
Standby action	For Type = Valve Raise only, this specifies the valve action when the instrument is in standby mode. Continue: Output continues at the demanded level. Freeze: The valve stops being driven.
Output	Off = output being driven low; On = output being driven high.

DC Output

This option provides a voltage (terminals 3A3B only) or mA output. Terminal location is shown in Figure 4.

 **DANGER**

HAZARD OF ELECTRICAL SHOCK, EXPLOSION OR ARC FLASH

Do not exceed the device's ratings.

Failure to follow these instructions will result in death or serious injury.

There are no mechanical interlocks to prevent a chassis with the DC output option being fitted into a 'sleeve' or case' which has previously been wired for the standard relay output. Before fitting the chassis into the case, it must be ensured that the terminal wiring is not attached to live voltage supplies, as such voltages may cause permanent damage to the instrument.

Configuration display

As shown in Figure 132, highlight the required DC output, then operate the scroll button to reveal the configuration page.

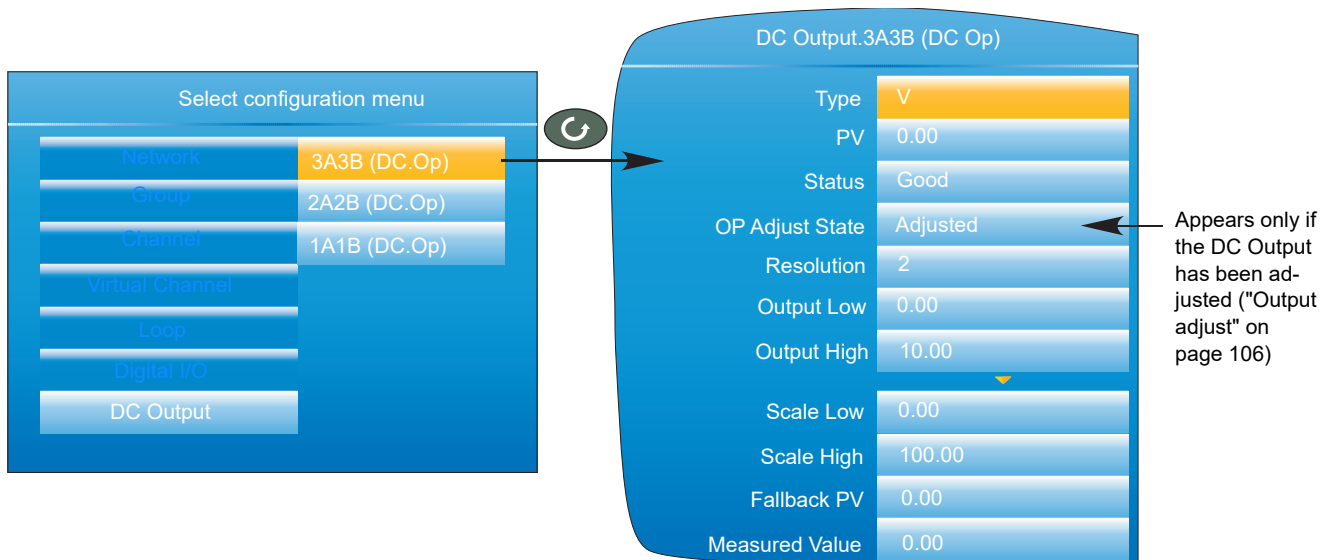

Figure 132 DC Output option configuration page (typical)

Parameters

Type	Select V(olts) (3A3B only) or mA as the output type.
PV	Input value to the function. Normally 'wired' to a suitable parameter.
Status	The status of the input parameter.
OP Adjust State	Adjusted. Appears only if the Output Adjust facility ("Output adjust" on page 106) has been used.
Resolution	The number of decimal places to be used for this configuration item.
Output Low	The minimum output value in Volts or mA as appropriate.
Output High	The maximum output value to be output in Volts or mA as appropriate.
Scale Low	See 'SCALING INFORMATION' below.
Scale High	See 'SCALING INFORMATION' below.
Fallback PV	The output value when the status of the input parameter is not 'good'.
Measured Value	The Voltage or mA value appearing at the output terminals

Note: The output voltage or current can be calibrated by using the output adjust procedure described in "Output adjust" on page 106.

Scaling Information

When PV = Scale Low, Output = output low value. When PV = Scale high, Output = output high value. The PV is mapped via the scale range onto the output range according to the equation:

$$Output = \left(\frac{PV - Scale\ Low}{Scale\ High - Scale\ Low} \right) (Output\ High - Output\ Low) + Output\ Low$$

User LIN

Allows the entry of up to four user linearisation tables, any one of which can be selected as 'Lin Type' in Channel configuration ("Channel Main" on page 123). Configuration consists of defining the number of points to be included (2 to 32) and then entering an X and a Y value for each point, where X values are the inputs and the Y values are the resulting outputs.

User linearisation table rules

1. Tables must be monotonic - i.e. there may not be more than one X value with the same Y value assigned to it.
2. Each X value must be greater than the preceding one.
3. Each Y value must be greater than the preceding one.
4. If units other than temperature units are to be displayed, the channel scale high and scale low values should be set to the same as the range high and low values, and the required scale units entered.

Figure 133 shows the first part of the configuration table for an imaginary cylinder example.

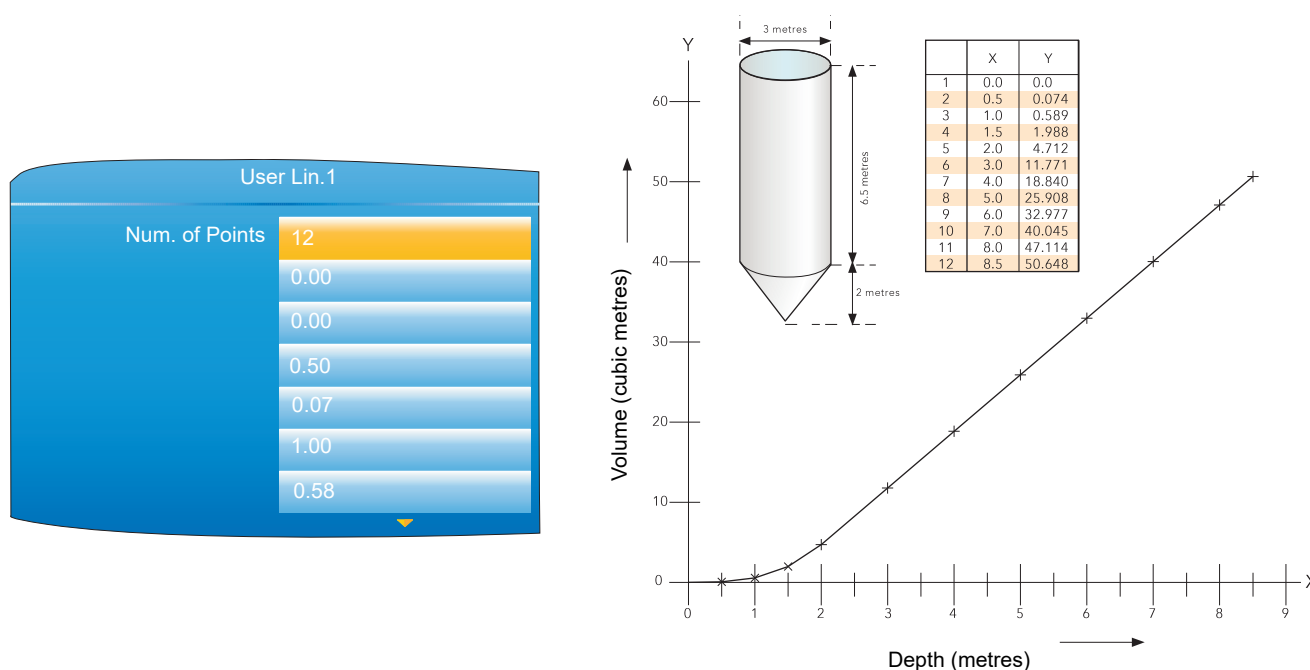

Figure 133 User Linearisation table example

When configuring a channel ("Channel Main" on page 123) to use a User linearisation table:

If Type = Thermocouple or RTD, then Range High/Low must be set to the highest and lowest 'Y' values to be used, respectively. The instrument automatically looks up the associated 'X' mV or Ohms values. If Type = mV, V or mA, then Range High/Low must be set to the highest and lowest 'Y' values to be used, respectively. Input High/Low should be set to the highest and lowest 'X' values in the table, respectively.

Custom Messages

This feature allows the entry of up to 10 messages for sending to the history file, when triggered by a wired source (e.g. an alarm going active).

The messages of up to 100 characters each are entered using either the virtual keyboard, described in "Text Entry" on page 89, or by means of iTools configuration software ("iTOOLS").

Up to three parameter values may be embedded in messages in the format [Address], where 'Address' is the decimal Modbus address of the parameter ("Parameter List" on page 232). E.G. [256] embeds Channel 1 PV.

Zirconia Block Option

This option allows the calculation of Carbon Potential, Dew point or Oxygen concentration. A zirconia (oxygen) probe consists of two platinum electrodes bonded to a pellet or cylinder of zirconia. At elevated temperatures, such a probe develops an emf across it which is proportional to the probe absolute temperature and to the log of the difference in oxygen partial pressure between its two ends.

The temperature of the probe is normally measured using a type K or type R thermocouple. The temperature effect on the thermocouple is such, that for successful operation, the probe temperature must be greater than 973K (700C).

Definitions

Temperature Control

The sensor input of the temperature loop may come from the zirconia probe but it is common for a separate thermocouple to be used. The controller provides a heating output which may be used to control gas burners. In some applications a cooling output may also be connected to a circulation fan or exhaust damper.

Carbon Potential Control

The zirconia probe generates a millivolt signal based on the ratio of oxygen concentrations on the reference side of the probe (outside the furnace) to the amount of oxygen in the furnace.

The controller uses the temperature and carbon potential signals to calculate the actual percentage of carbon in the furnace. This second loop generally has two outputs. One output is connected to a valve which controls the amount of an enrichment gas supplied to the furnace. The second output controls the level of dilution air.

Sooting Alarm

In addition to other alarms which may be detected by the controller, the instrument can trigger an alarm when the atmospheric conditions are such that carbon will be deposited as soot on all surfaces inside the furnace. The alarm may be wired to an output (e.g. relay) to initiate an external alarm.

Clean Probe

As these sensors are used in furnace environments they require regular cleaning. Cleaning (Burn Off) is performed by forcing compressed air through the probe. Cleaning can be initiated either manually or automatically using a timed period. During cleaning 'PV Frozen' is set to 'Yes'.

Automatic Probe Cleaning

The instrument has a probe clean and recovery strategy that can be programmed to occur between batches or be manually requested. At the start of the cleaning process a 'snapshot' of the probe mV is taken, and a short blast of compressed air is used to remove any soot and other particles that may have accumulated on the probe. A minimum and maximum cleaning time can be set by the user. If the probe mV has not recovered to within 5% of the snapshot value within the maximum recovery time set then an alarm is given. This indicates that the probe is ageing and replacement or refurbishment is due. During the cleaning and recovery cycle the PV is frozen, thereby ensuring continuous furnace operation. The 'PV Frozen' parameter can be used in an individual strategy, for example to hold the integral action during cleaning.

Endothermic Gas Correction

A gas analyser may be used to determine the carbon monoxide (CO) concentration of the endothermic gas. If a 4 to 20mA output is available from the analyser, this can be applied to the instrument to adjust the calculated percentage carbon reading automatically. Alternatively, this value can be entered manually.

Oxygen Concentration

In order to measure oxygen concentrations, one end of the probe is inserted into the atmosphere to be measured, whilst the other is subjected to a reference atmosphere. For most applications, air provides a suitable reference (reference input = 20.95 for air).

Configuration

The configuration parameters appear in one of three lists as shown in [Figure 134](#).

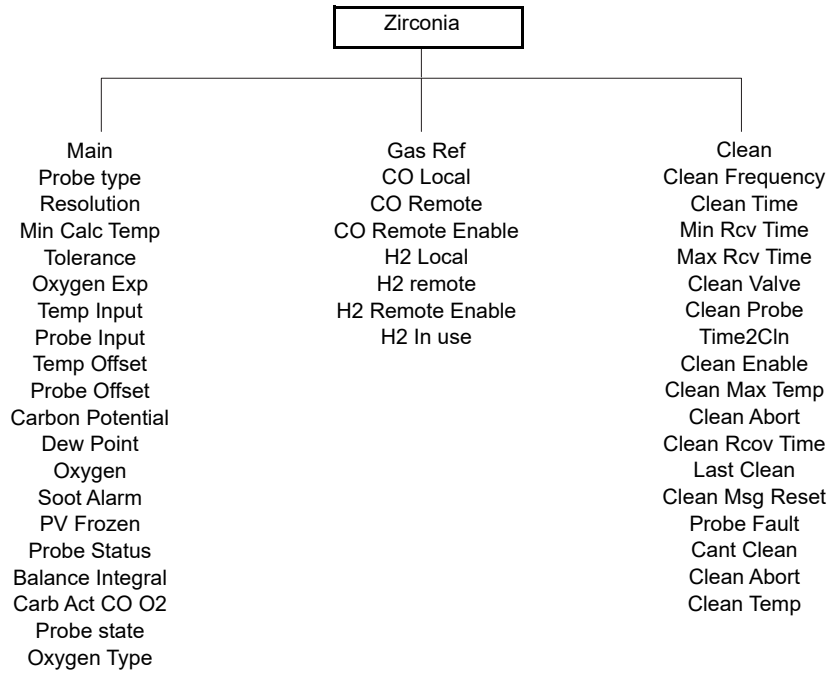

Figure 134 Zirconia probe configuration layout.

Zirconia Main

The parameters that appear depend on the 'Probe Type' setting. For this reason, not all the parameters listed appear for all probe types. [Figure 135](#) shows a typical configuration page.

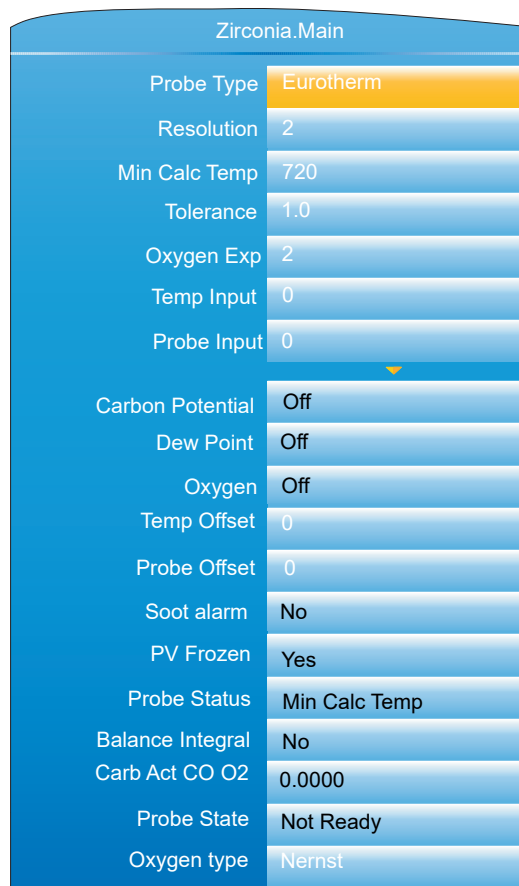

Figure 135 Zirconia Probe configuration (typical)

Main Parameters

Probe Type	Select from a variety of probe manufacturers. The subsequent parameter list depends on which manufacturer is selected.								
Resolution	Enter the number of decimal places to be used for the value display.								
Gas Reference	Reference value for the hydrogen concentration in the atmosphere.								
Rem Gas Ref	Remote reference value for hydrogen concentration in the atmosphere. Allows hydrogen concentration to be read from an external source.								
Rem Gas Enable	'Yes' allows remote gas measurement. 'No' uses the internal Gas Reference value.								
Working Gas	Read only. Working Reference Gas value.								
Min Calc Temp*	The minimum temperature at which the calculation is valid.								
Oxygen Exp	The exponent units of the log oxygen type calculation. valid entries -24 to +24.								
Tolerance	Sooting tolerance multiplier. Allows the user to adjust the sensitivity of the Sooting alarm, in order to reduce the incidence of nuisance alarms.								
Process Factor	Process factor defined by the probe manufacturer.								
Clean Frequency	Allows the interval between probe cleaning cycles to be entered in hours and minutes.								
Clean Time	Allows Probe clean time to be entered in hours and minutes.								
Min Rcov Time	The minimum recovery time after purging in hours and minutes.								
Max Rcov Time	The maximum recovery time after purging in hours and minutes.								
Temp Input*	Zirconia probe temperature input value.								
Temp Offset*	Allows a temperature offset to be entered for the probe.								
Probe Input	Zirconia probe mV input.								
Probe mV Offset	Allows an offset to be entered for the probe mV input.								
Oxygen	Read only. The calculated oxygen value.								
Carbon Potential	Read only. The calculated carbon potential.								
Dew Point	Read only. The dew point value derived from temperature and remote gas reference inputs.								
Soot Alarm	Read only. Sooting alarm. Active if sooting is likely to take place. The sensitivity of the alarm can be adjusted by using the 'Tolerance' parameter, above.								
Probe Fault	'Yes' indicates a sensor break.								
PV Frozen	Read only. Parameter set to 'Yes' during Probe cleaning.								
Clean Valve	Read only. Enable the Clean valve.								
Clean State	Read only. The burn off state of the zirconia probe: 'Waiting', 'Cleaning' or 'Recovering'.								
Clean Probe	'Yes' = Initiate probe cleaning. 'No' = Do not clean probe.								
Time to Clean	Read only. The time remaining, in hours and minutes until the next cleaning cycle is due.								
Probe Status	Read only. Current probe status: <table> <tr> <td>OK</td> <td>Normal working</td> </tr> <tr> <td>mV Sensor Brk</td> <td>Probe input sensor break</td> </tr> <tr> <td>Temp Sensor Brk</td> <td>Temperature input sensor break</td> </tr> <tr> <td>Min Calc Temp</td> <td>Probe deteriorating</td> </tr> </table>	OK	Normal working	mV Sensor Brk	Probe input sensor break	Temp Sensor Brk	Temperature input sensor break	Min Calc Temp	Probe deteriorating
OK	Normal working								
mV Sensor Brk	Probe input sensor break								
Temp Sensor Brk	Temperature input sensor break								
Min Calc Temp	Probe deteriorating								

Balance Integral	This output goes 'true' when a step change in the output occurs, which requires an integral re-balance if the readings are used for PID control.
Carb Act CO O2	The carbon activity for the surface gas reaction between Carbon monoxide (CO) and Oxygen (O2).
Probe State	Read only. The current state of the probe. If 'Measuring', then the outputs are updated. For any other state (Clean, Clean Recovery, Test impedance, Impedance Recovery, Waiting), the outputs are not updated.
Oxygen Type	Oxygen equation being used.

Gas References Parameters

CO Local	Reference value for the carbon monoxide (CO) concentration in the atmosphere.
CO Remote	Remote reference value for the carbon monoxide concentration in the atmosphere. Allows the value to be read remotely.
CO Remote En	'Yes' allows remote CO measurement. 'No' uses the internal value.
CO in Use	The CO gas measurement value currently being used.
H2 Local	Reference value for the hydrogen (H) concentration in the atmosphere.
H2 Remote	Remote reference value for the hydrogen concentration in the atmosphere. Allows the value to be read remotely.
H2 Remote En	'Yes' allows remote H measurement. 'No' uses the internal value.
H2 In Use	The H gas measurement value currently being used.

Clean Parameters

Clean Frequency	Allows the interval between probe cleaning cycles to be entered in hours and minutes.
Clean Time	Allows Probe clean time to be entered in hours and minutes.
Min Rcov Time	The minimum recovery time after purging in hours and minutes.
Max Rcov time	The maximum recovery time after purging in hours and minutes.
Clean Valve	Read only. Enable the Clean valve.
Clean Probe	Initiate probe cleaning.
Time to Clean	Read only. The time remaining, in hours and minutes until the next cleaning cycle is due.
Clean Enable	Enable probe cleaning.
Clean Max Temp	Maximum temperature for cleaning. If the temperature exceeds this value, cleaning is aborted.
Clean Abort	Abort probe cleaning.
Clean Rcov Time	The time taken for the probe to recover to 95% of its original value after the last clean. If the last clean did not recover within the Max Rcov time, this value is set to 0.
Last Clean	The mV output from the probe after the last clean.
Clean Msg Reset	'Yes' clears cleaning related alarms.
Probe Fault	'Yes' means that the probe failed to recover to 95% of its original output, following a clean.
Cant Clean	Conditions exist which prevent a clean cycle starting. Can be cleared using 'Clean Msg Reset'.
Clean Abort	A clean cycle was aborted. Can be cleared using 'Clean Msg Reset'.

Clean Temp

A clean cycle was aborted because the temperature was too high. Can be cleared using 'Clean Msg Reset'.

Zirconia Probe Wiring

Figure 136 shows a typical wiring arrangement for a Zirconia probe.

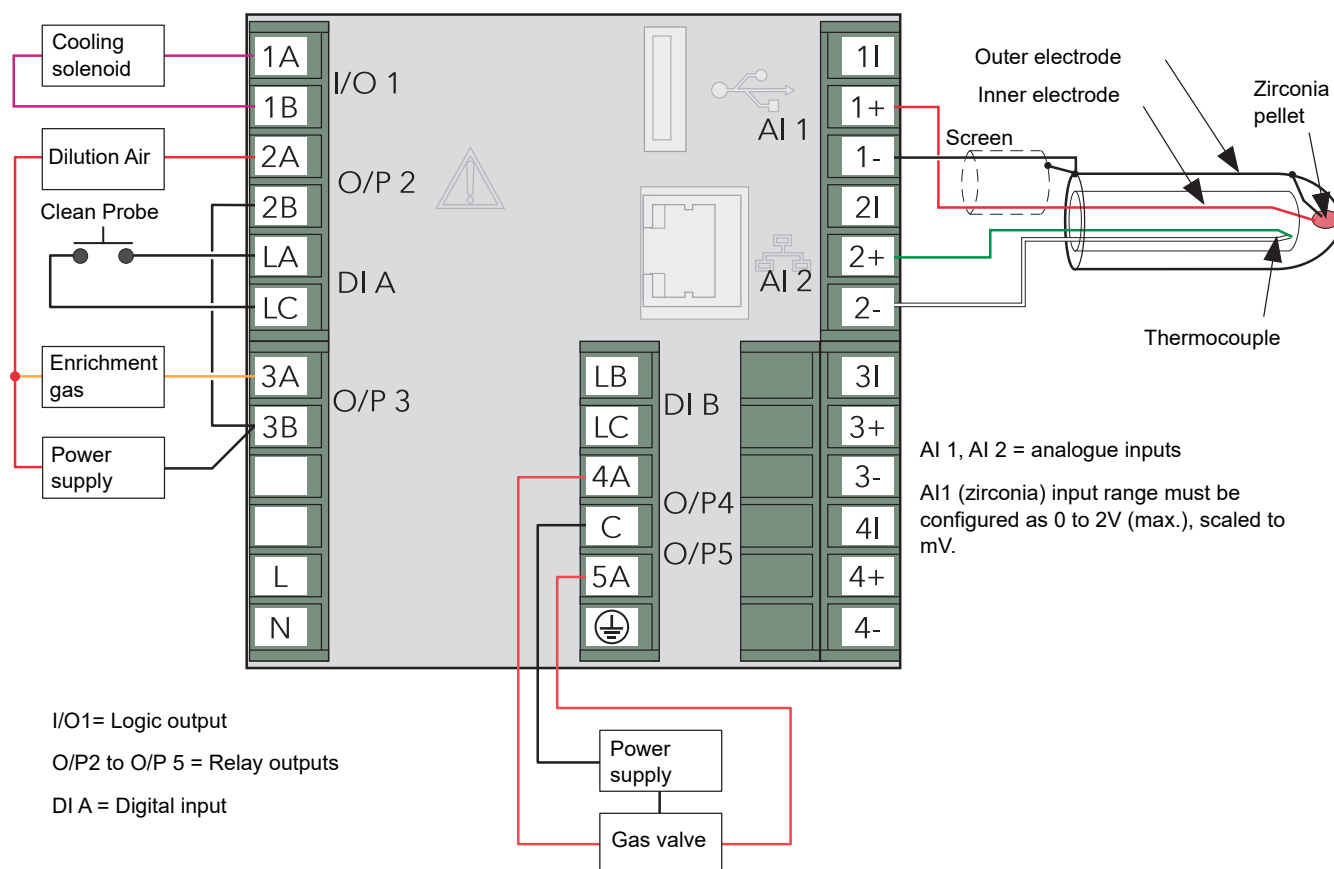

Figure 136 Typical Zirconia probe wiring

Steriliser Option

This block provides a means of recording complete sterilisation cycles, including for example, venting and pumping as well as the actual sterilising period. See "Steriliser Display Mode" on page 70 for display mode details. Data is stored in .uhh history files for viewing in Review software.

Steriliser	
Cycle status	Wait Start
Remaining	00:00:00
Equilibration	00:00:00
Sterilising	00:00:00
Total Cycle	00:00:00
F ₀ (A ₀)	00:00:00
Running Output	No
Passed Output	No
Start	No
Start 121°C	No
121°C Time	00:03:00
Start 134°C	No
134°C Time	00:15:00
Target Time	00:03:00
Cycle Number	0
Auto Counter	No
File by Tag	X
Input 1 Type	Thermocouple
PV1	0
Target SP	134
Band Low	134
Band High	137
Failure Dwell	00:00:00
Input 2 Type	Thermor Detect
Failure Dwell	00:00:00
Measured Temp.	115
Target Temp.	134
Z Temp.	10
Low Limit	134

Figure 137 Steriliser block configuration menu

Configuration parameters

Cycle Status	Wait start: The cycle is waiting to be started. Waiting: Waiting for input 1 to reach its target setpoint. Equilibration: Currently in the equilibration period. Sterilising: Currently in the sterilising phase. Passed: The cycle has completed successfully. Failed: The cycle has failed. Test cycle: A test cycle is in progress
Remaining	The sterilising time remaining for the current cycle.
Equilibration	The equilibration time period for the current cycle.
Sterilising	The time for which the load has currently been at sterilisation conditions.
Total Cycle	The total cycle time.
F ₀ (A ₀)	The current F ₀ , F _H or A ₀ value.

Passed Output Start	‘Yes’ = Output passed; ‘No’ = Output did not pass. Trigger to start a custom cycle (i.e. one for which High and Low band and/or Target set- point have been changed from their default values.)	
Start 121°C	Trigger to start a pre-defined 121°C cycle (Setpoint, Band Low/Band High etc. values are set to their 121° defaults when the cycle is initiated).	
121°C Time	Target time for a 121°C cycle. Automatically copied to the ‘Target Time’ field when Start 121°C requested. Scrollable value in hh:mm:ss format.	
Start 134°C	Trigger to start a pre-defined 134°C cycle (Setpoint, Band Low/Band High etc. values are set to their 134° defaults when the cycle is initiated)	
134°C Time	Target time for a 134°C cycle. Automatically copied to the ‘Target Time’ field when Start 134°C requested. Scrollable value in hh:mm:ss format.	
Target Time	The time for which the input values must remain at their sterilisation values in order that the cycle shall pass. The cycle fails if any input moves outside its specified band limits during the Target Time. Scrollable value in hh:mm:ss format.	
Cycle Number	Each execution of the Steriliser block uses a unique cycle number. This may be entered manually, or can be set to increment automatically by setting ‘Auto Counter’ (below) to ‘Yes’.	
Auto Counter	‘Yes’ causes the Cycle Number (above) to increment automatically each time a new cycle is initiated. If Auto counter = ‘Yes’, the Cycle Number forms part of the historical data and can be used to help identify data during later review.	
File By Tag	‘Tick’ ensures that each cycle is recorded in its own unique history file identified by cycle number and ‘File tag’ (below).	
File tag	This field appears only if ‘File By Tag’ is enabled (tick symbol). File tag allows a four- character identifier to be entered to be used with the Cycle Number (above) to identify the history file.	
Input n Type	Select ‘Off’, ‘Thermocouple’, ‘Rising Pressure’, ‘Falling pressure’, ‘Rise Air Detect’, or ‘Fall Air Detect’.	
	Off	This input will not be included in steriliser monitoring calculations.
	Thermocouple	Degrees Celsius input.
	Rising pressure	A mBar pressure input with a rising pressure expected during the cycle. This pressure input would normally be synchronised with a temperature input, in the same chamber, when performing a 121 °C or 134°C cycle.
	Falling pressure	As ‘Rising Pressure’ above, but with a falling pressure expected during the cycle.
	Rise Air DetectA	mBar pressure input with a rising pressure expected during the cycle. This pressure input is not synchronised with a temperature input when performing a 121 °C or 134°C cycle, as it is (typically) an outside chamber pressure.
	Fall Air DetectAs	‘Rise Air Detect’ above, but with a falling pressure expected during

PV n	Input value (wireable only). See Note 1 below.
Target SP	Target setpoint for this input. (Does not appear if relevant Input Type = 'Off'.) See Note 2 below.
Band Low/High	The low and high steriliser temperature or pressure band for this input. (Does not appear if relevant Input Type = 'Off'). See Note 2 below. Values are effective only during Sterilisation mode.
Failure Dwell	A failure alarm is set if this input is out of band range for more than the Failure Dwell time. Scrollable value in hh:mm:ss format.

Notes:

- n = 1 to 4, where typically, inputs 1 to 3 are temperature inputs and input 4 is a pressure input.
- Target SP and Band High/Low values are set to their relevant default values when a 121°C or 134°C cycle is initiated.

Measured Temp.	For F0 or A0 calculations, this value must be in °C. Typically wired to an input channel PV.
Target Temp.	For F0 or A0 calculations, the target temperature (see "Steriliser Display Mode" on page 70 for details). This typically is the same value as the Target SP (above).
Z Temp.	For F0 or A0 calculations this is a temperature interval representing a factor-of-10 increase in killing efficiency. Z = 10°C for F0 and A0, and 20°C for FH
Low Limit	The temperature below which F0 or A0 calculations are suspended.

Saturated Steam Option

This block provides the means to record the following attributes of saturated steam:

- Saturated Steam Mass Flow. Calculates mass flow in kg/s for saturated steam, using either the steam temperature (°C) or pressure (MPa) as appropriate to the process.
- Saturated Steam Heat Flow. Calculates the energy flow in kJ/s for saturated steam, using either the steam temperature (°C) or pressure (MPa) as appropriate to the process.
- Saturated Steam Heat Consumed. Calculates the heat consumed in kJ/s for saturated steam, using the inlet steam temperature (°C) or pressure (MPa) (as appropriate to the process), and the return (condensate) temperature.
- Saturated Steam Enthalpy. Calculates the enthalpy in kJ/kg for saturated steam, using either the steam temperature (°C) or pressure (MPa) (as appropriate to the process).

Note: The overall accuracy of a flow measurement installation depends on a number of factors outside the control of the data recorder manufacturer. For this reason, the data recorder manufacturer takes no responsibility for the accuracy of the results obtained using the mass flow equations implemented in the nanodac software.

Note: For the Saturated Steam block, Pressure is always in MPa and Temperature in °C. Other units need to be converted accordingly.

There are two instances of the Saturated Steam block available on the instrument. These can be configured independently of each other. The 'Saturated Steam.2' block is fixed to 'Enthalpy'. See the parameter descriptions, below for more details.

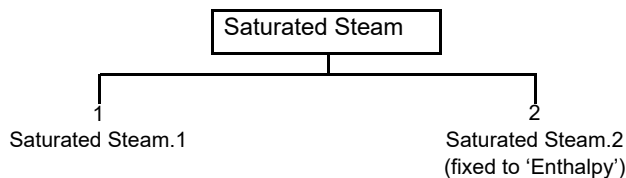

Figure 138 Saturated Steam configuration layout

Saturated Steam.1	
Saturated Steam	Mass Flow
Mass Flow Output	0.00
Heat Flow Output	0.00
Heat Consumed	0.00
Flow	0.00
Return Temp	0.00
Use	Temperature
Pressure	0.0000
Temperature	0.00
Dryness	0.0
Resolution	2
Water Enth	-0.04
Steam Enth	0.00
Calculate Value	0.00

Figure 139 Saturated Steam configuration

Saturated Steam	The Saturated Steam Mode. One of: 'Mass Flow', 'Heat Flow', 'Heat Consumed', 'Heat- Mass Flow', or 'Enthalpy'. Depending on the mode selected, other parameters in this list may or may not be displayed. See individual parameter descriptions for details.
Mass Flow Output	The Mass Flow output of the saturated steam calculation. Only shown when the Saturated Steam Mode is set to either 'Mass Flow' or 'Heat-Mass Flow'.
Heat Flow Output	The Heat Flow output of the saturated steam calculation. Only shown when the Saturated Steam Mode is set to either 'Heat Flow' or 'Heat-Mass Flow'.
Heat Consumed	The Heat Consumed output of the saturated steam calculation. Only shown when the Saturated Steam Mode is set to 'Heat Consumed'.
Flow	The flow input (m ³ /s). Not shown if the Saturated Steam Mode is set to 'Enthalpy'.
Return Temp	The return (condensate) temperature input. Only shown when the Saturated Steam Mode is set to 'Heat Consumed'.
Use	Selects either 'Pressure' or 'Temperature' as the basis for the calculation.
Pressure	The steam pressure input (MPa). Only shown when Use is set to 'Pressure'.
Temperature	The steam temperature input (°C). Only shown when Use is set to 'Temperature'.
Dryness	The dryness percentage of the steam (where 0% = no va-

Notes: The units of kg/s and m³/s are used here for simplicity. In fact, any time unit can be used. For example, if the measured flow is in m³/hr, then the Mass flow will be in kg/hr.

Note: ASME Steam tables 1999, from IAPWF IF97.

Resolution	The resolution (number of decimal places) of the output values.
Water Enth	The Water Enthalpy value (kJ/kg). Only shown when the Saturated Steam Mode is set to 'Enthalpy'.
Steam Enth	The Total Steam Enthalpy (kJ/kg). Only shown when the Saturated Steam Mode is set to 'Enthalpy'.
Calculate Value	When Use is set to 'Temperature', this is the corresponding pressure (MPa). When Use is set to 'Pressure', this is the corresponding temperature (°C).

Pressure Units Conversion

There is a wide range of pressure measuring units in use throughout the world. The following table gives multiplication factors for converting some common units to MPa (MegaPascals), to four significant figures. Further conversion factors can be found at the websites: <http://www.cleavebooks.co.uk/scol/ccpress.htm> and <http://www.onlineconversion.com/pressure.htm>, amongst others. (Where the conversion is to Pascals, not to MegaPascals, the factors here have to be divided by 1,000,000.)

Pressure units	Multiplier for MPa	Pressure units	Multiplier for MPa
Atmospheres	0.1013	Newtons/cm ²	0.01
Bar	0.1	Newtons/m ²	0.000 001
kg/cm ²	0.09 807	Pascals	0.000 001
kNewton/m ²	0.001	Tonnes/m ²	0.009 807
kPa	0.001	Tons(UK)/ft ²	0.1 073
mBar	0.0001	Tons(US)/ft ²	0.09 576
Lb/ft ²	0.00 004 788	Water (feet of)	0.002 989
Lb/in ² (PSI)	0.006 895	Water (inches of)	0.0 002 491
Mercury (inches of)	0.003 386	Water (mm of)	0.000 009 807
Mercury (mm of)	0.0 001 333		

Figure 140 Pressure units conversion

Saturated Steam Mass Flow Calculation

The following calculation is performed:

For a given Volume V , Temperature T and dryness d the mass flow is given by:

$$MassFlow(kg/s) = \frac{V}{V_{LT} + \Delta V_T \frac{d}{100}}$$

V_{LT} is V_L at temperature T from the 1999 ASME steam tables.

ΔV_T is ΔV at temperature T from the 1999 ASME steam tables.

A similar calculation is performed if pressure is used.

Saturated Steam Heat Flow Calculation

Uses a lookup from the 1999 ASME Steam Tables to determine the energy (Enthalpy) of water and water vapour in the given volume of gas.

For a given Volume V , Temperature T and dryness d the energy flow is given by:

Where:

$$\text{Energy}(kJ/s) = \left(\frac{V}{V_{LT} + \Delta V_T \frac{d}{100}} \right) \left(h_{LT} + \Delta h_T \frac{d}{100} \right)$$

V_{LT} is V_L at temperature T from the 1999 ASME steam tables.

ΔV_T is ΔV at temperature T from the 1999 ASME steam tables.

h_{LT} is h_L at temperature T from the 1999 ASME steam tables.

Δh_T is Δh at temperature T from the 1999 ASME steam tables.

A similar calculation is performed if pressure is used.

Saturated Steam Heat Consumed Calculation

Uses a lookup from the 1999 ASME Steam Tables to determine the energy (Enthalpy) of water and water vapour in the given volume of gas.

For a given Volume V , Inlet Temperature T and inlet dryness d and condensate return temperature T , the energy consumed is given by:

$$\text{Energy}(kJ/s) = \left(\frac{V}{V_{LT} + \Delta V_T \frac{d}{100}} \right) \left(h_{LT} + \Delta h_T \frac{d}{100} - h_{LT} \right)$$

Where:

V_{LT} is V_L at temperature T from the 1999 ASME steam tables.

ΔV_T is ΔV at temperature T from the 1999 ASME steam tables.

h_{LT} is h_L at temperature T from the 1999 ASME steam tables.

Δh_T is Δh at temperature T from the 1999 ASME steam tables.

h_{LT} is h_L at temperature T from the 1999 ASME steam tables.

Note: This calculation assumes 100% wet saturated water in the condensate return, it ignores any flash steam component. Also it is assumed that the same mass is leaving the system as is entering it.

A similar calculation is performed if pressure is used.

Saturated Steam Enthalpy Calculation

Uses a lookup from the 1999 ASME Steam Tables to determine the energy (Enthalpy) of water and steam at the given Temperature or Pressure and Dryness. The Water Enthalpy is unchanged from the value in the table, whilst the Steam Enthalpy is reduced by the Dryness factor as follows:

$$\text{SteamEnthalpy}(kJ/s) = h \frac{d}{100}$$

where:

h is steam enthalpy at the required Temperature or Pressure from the 1999 ASME steam tables. d is the Dryness factor.

In Temperature mode, the Calc Value parameter returns the equivalent Pressure for the given Enthalpy value.

Similarly, in Pressure mode the Calc Value returns the equivalent Temperature. Since there are separate tables for Temperature and Pressure, the Calc Value is found by a reverse look-up in the inactive table.

Mass Flow Option

The Mass Flow option calculates mass flows from either linear or square root type transducer outputs.

Note: The overall accuracy of a flow measurement installation depends on a number of factors outside the control of the data recorder manufacturer. For this reason, the data recorder manufacturer takes no responsibility for the accuracy of the results obtained using the mass flow equations implemented in the data recorder software.

Note: The units of kg/s and m³/s are used here for simplicity. In fact, any time unit can be used. For example, if the measured flow is in m³/hr, then the Mass flow will be in kg/hr.

Note: ASME Steam tables 1999, from IAPWF IF97.

Linear Mass Flow Calculation

The equation solved is:

$$QM_{xt} = \left(\frac{K}{Rg^{xZ}} x \frac{\text{Flow}_t^x \text{Abz} P_t}{\text{Temp}} \right)$$

where:

QM_{xt} = Mass flow with a dryness factor of x , at time t , in kg/sec.

K = Scaling factor (see below).

Z = Compressibility factor (see below).

$Flow_t$ = Measured value from the flow meter at time t .

$AbsP_t$ = Absolute pressure of the fluid at time t in kPa(A).

$Temp$ = Temperature of the fluid in Kelvins.

Scaling factor (K) This is determined from an assumed value of QM at a known Flow, AbsPt and Temp. The value is chosen to give an output within the range low scale to high scale and is given by the equation:

$$K = \frac{S}{ma_{max}}$$

where:

S = Full scale output from the flow meter in flow meter units.

ma_{max} = Full scale input range set for 'Flow' channel in flow meter units.

Specific gas constant

The specific gas constant for any gas is available from published tables.

Compressibility factor (Z)

Compressibility factor is a density-related measure of how far a particular gas deviates from a 'perfect' gas under any set of temperature and pressure conditions, and is given by the equation:

$$Z = \frac{P}{T} \times \frac{1}{\rho}$$

where:

P = Absolute pressure of the gas in kPa(A).

T = Absolute temperature of the gas (Kelvins).

ρ = Gas density at pressure P and temperature T (from published tables).

Root Mass Flow Calculation

The equation solved is:

$$QM_{xt} = \left(\frac{K^2}{Rg^x Z} \times \sqrt{\frac{DeltaP_t^x AbsP_t}{Temp}} \right)$$

where:

QM_{xt} = Mass flow with a dryness factor of x , at time t , in kg/s.

K = Scaling factor (see below).

Rg = Specific gas constant in J/kg-K from published tables.

Z = Compressibility factor (see below).

$DeltaP_t$ = Measured value across the orifice plate at time t

$AbsP_t$ = Absolute pressure of the fluid at the up-stream tapping at time t in kPa(A).

$Temp$ = Temperature of the fluid at the up-stream tapping in Kelvins.

Scaling factor (K) This is determined from an assumed value of QM at a known $Flow$, $AbsP_t$ and $Temp$. The value is chosen to give an output within the range low scale to high scale and is given by the equation:

$$K = \frac{S}{ma_{max}}$$

where:

S = Full scale output from the flow meter in flow meter units.

ma_{max} = Full scale input range set for 'Flow' channel in flow meter units.

Specific gas constant
The specific gas constant for any gas is available from published tables.

Compressibility factor (Z)
Compressibility factor is a density-related measure of how far a particular gas deviates from a 'perfect' gas under any set of temperature and pressure conditions, and is given by the equation:

$$Z = \frac{P}{T} \times \frac{1}{\rho}$$

where:

P = Absolute pressure of the gas in kPa(A).

T = Absolute temperature of the gas (Kelvins).

ρ = Gas density at pressure P and temperature T (from published tables).

Configuration

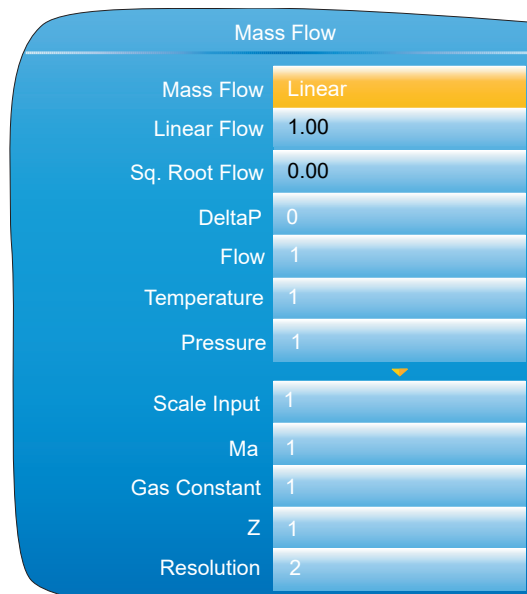

Figure 141 Mass Flow configuration

Mass Flow	The type of Mass Flow calculation. One of: 'Linear', or 'Square Root'.
Linear Flow	The output of the mass flow calculation. Only shown when the mass flow calculation is set to 'Linear'.
Sq. Root Flow	The output of the mass flow calculation. Only shown when the mass flow calculation is set to 'Square Root'.
DeltaP	The differential pressure input. Only shown when the mass flow calculation is set to 'Square Root'.
Flow	The flow input. Only shown when the mass flow calculation is set to 'Linear'.
Temperature	The fluid temperature input (Kelvin).
Pressure	The absolute gas pressure input (kPa(A)).
Scale Output	The full scale output from the flowmeter in flowmeter units.
Ma	The full scale input range of the 'Flow' channel (ma_{max}).
Gas Constant	The relevant gas constant (J/kg-K).
Z	The compressibility factor.
Resolution	The resolution (number of decimal places) of the output values.

Humidity Block Option

This block uses wet and dry bulb temperatures, and atmospheric pressure inputs to derive values for relative humidity and dew point.

Humidity	
Resolution	2
Psychro Constant	6.66E-4
Pressure	1013.0
Wet Temperature	28.23
Wet Offset	0
Dry Temperature	29.65
Relative Hum.	89.93
Dew Point	27.83
Sensor Break	No

Figure 142 Humidity calculation configuration

Configuration parameters

Resolution	The number of decimal places for the Relative humidity and Dew point displays.
Psychro constant	The psychrometric constant (default = 6.66×10^{-4}) (see note below)
Pressure	The current atmospheric pressure in mBar.
Wet Temperature	The wet bulb thermometer temperature.
Wet Offset	Offset for the wet bulb temperature.
Dry Temperature	The dry bulb thermometer temperature.
Relative Hum.	The relative humidity value calculated from the Wet temperature, the Dry temperature and the Pressure inputs. The number of decimal places depends on the Resolution setting

Dew Point	The dew point value calculated from the Wet temperature, the Dry temperature and the Pressure inputs. The number of decimal places depends on the Resolution setting.
Sensor Break	'Yes' implies that a break has occurred between one (or more) of the temperature or pressure transducer and its input.

Note: The default value 6.66 may be edited, but the multiplier is always 10⁻⁴ (i.e. it cannot be edited).

BCD Input

Part of the 'Toolkit Blocks' option, this block derives decimal and two-decade binary coded decimal (BCD) values from eight discrete inputs, where input 1 is the least significant input (2⁰ = 1) and input 8 is the most significant (2⁷ = 128). The example below shows that for inputs 2, 4, 6 and 8 high, the decimal input value is 170, but the BCD value is invalid. In any such case, the maximum BCD value for each decade is limited to 9.

Input number	8	7	6	5	4	3	2	1	
Input status	1	0	1	0	1	0	1	0	
Decimal input	128	0	32	0	8	0	2	0	(=170)
BCD output	1	0	1	0	1	0	1	0	(=10, 10)

Figure 143 BCD block example

Input rules

Valid BCD outputs are produced only with the following inputs set:

1. Any combination of inputs 1, 2, 3, 5, 6 and 7
2. Any combination of Inputs 1, 4, 5 and 8

Configuration

BCD Input 1

Digital Input 1		
Digital Input 2		← Input active symbol
Digital Input 3		
Digital Input 4		
Digital Input 5		← Input not active symbol
Digital Input 6		
Digital Input 7		
Digital Input 8		
Decimal Byte	3	
Decimal Value	3	← Switch wired as in the example in "Programmer Display Mode" on page 59 and set to position 3.
Units	3	
Tens	0	
Settle Time	0.0secs	

Figure 144 BCD block configuration

Parameters

Digital Input N	Digital inputs, wired (for example) to contact inputs at the rear panel or to other suitable parameter outputs.
Decimal input	The value defined by the active inputs, where input 1 = 1, when active, input 2 = 2, input 3 = 4, input 4 = 8 and so on.
BCD Output	A two digit output being the binary coded decimal version of the input.
BCD LS Digit	This least significant (right-most) digit represents the value of inputs 1 to 4, where input 1 = 1, input 2 = 2, input 3 = 4, input 4 = 8. Maximum value = 9, even if input is greater than 9.
BCD MS Digit	This most significant (left-most) digit represents the value of inputs 5 to 8, where input 5 = 1, input 6 = 2, input 7 = 4, input 8 = 8. Maximum value = 9, even if input is greater than 9.
Settle Time	As the switch is turned from one value to another, intermediate switch positions may be seen on the inputs which could be used by subsequent blocks. Settle Time applies a filter to prevent these values from affecting other blocks.

Logic (2 Input) Block

Part of the 'Toolkit Blocks' option, this block allows a number of logic and comparison operations to be performed on a pair of inputs. For logic functions, the inputs can be inverted to allow, for example, a NOR function to be implemented by inverting the inputs to an AND function. 12 two-input logic blocks are available.

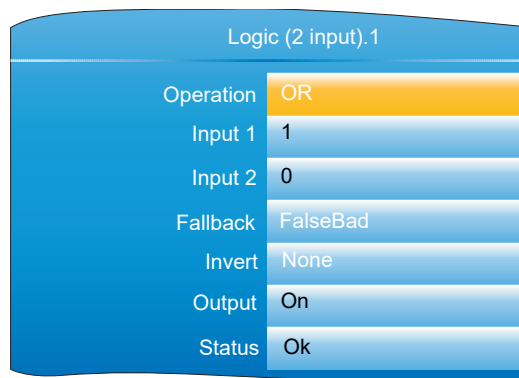

Figure 145 Two-input logic block configuration

Parameters

Operation	AND, OR, XOR, LATCH (boolean values only) == (Input 1 = Input 2) <> (Input 1 . Input 2) < (Input 1 < Input 2) <= (Input 1 = Input 2) > (Input 1 > Input 2) => (Input 1 = Input 2)
Input 1(2)	The inputs to the specified operation. For inverted inputs (below), this shows the 'real' (non-inverted) state.
Fallback	Configures the output and status values to be used if either input has a status other than 'Good'. FalseBad: Output = False; Status = Bad TrueBad: Output = True; Status = Bad

	FalseGood: Output = False; Status = Good
	TrueGood: Output = True; Status = Good
Invert	For logic operators only allows neither, either or both inputs to be inverted. Input 1 and Input 2 show the non-inverted state.
Output	On or Off depending on input states etc.
Status	The status of the result ('Ok' or 'Error').

Logic (8 Input) Block

Part of the 'Toolkit Blocks' option, this block allows AND, OR and cascading* XOR logic operations to be carried out on up to eight inputs.

*Cascading XOR example for inputs 1 to 4: (((Input1 \oplus Input2) \oplus Input3) \oplus Input4).

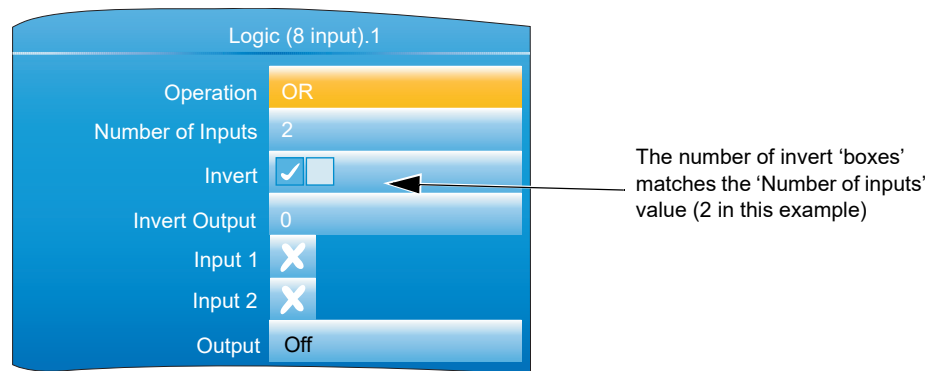

Figure 146 Eight input logic block configuration

Parameters

Operation	AND, OR or XOR
Number of inputs	The number of inputs to the logic operator
Invert	Allows the user to invert individual inputs, as described below.
Invert Output	'Yes' inverts the output status
Input 1	The status of input 1, ignoring the Invert status. Cross = off; Tick = on.
Inputs 2 to N	As for input 1, where N = the value of the 'Number of Inputs' parameter.
Output	On or Off. Includes the effect of 'Invert Output' status.

Input Inversion

1. Use the down arrow key to highlight the 'Invert' field and operate the scroll key to enter edit mode
2. Use the up arrow key to highlight the first input to be inverted (the relevant input numbers appear in the display boxes for uninverted inputs when highlighted).
3. Once the required input box is highlighted, use the scroll key to change the numeric character to a tick symbol (to invert) or change the tick character to a numeric character (to remove a previous inversion).
4. Repeat for any further inputs, then operate the page key to confirm the changes and to quit edit mode.

Schematic

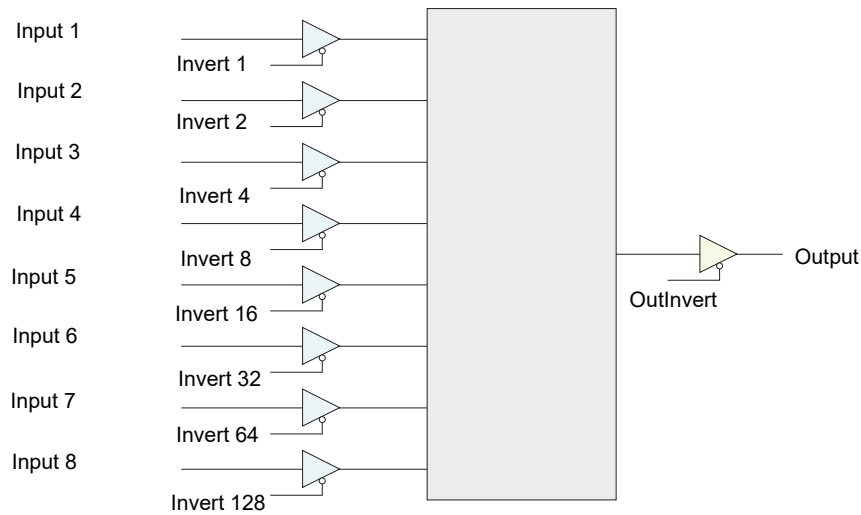

Figure 147 Logic (8 input) block schematic

Invert input decoding table

Over a communications link, the inversion status is transmitted as a decimal value, which can be encoded/de-coded using the following table:

Input				Hex	Dec	Input				Hex	Dec	Input				Hex	Dec	Input				Hex	Dec																	
8	7	6	5	4	3	2	1	Hex	Dec	8	7	6	5	4	3	2	1	Hex	Dec	8	7	6	5	4	3	2	1	Hex	Dec	8	7	6	5	4	3	2	1	Hex	Dec	
N	N	N	N	N	N	N	N	00	0	N	N	6	5	N	N	2	1	33	51	N	7	6	I	N	3	2	N	66	102	8	N	N	5	4	N	N	1	99	153	
N	N	N	N	N	N	N	N	01	1	N	N	6	5	N	3	N	N	34	52	N	7	6	N	N	3	2	1	67	103	8	N	N	5	4	N	2	N	9A	154	
N	N	N	N	N	N	N	2	N	2	N	N	6	5	N	3	N	1	35	53	N	7	6	N	4	N	N	N	68	104	8	N	N	5	4	N	2	1	9E	155	
N	N	N	N	N	N	N	2	1	03	3	N	N	6	5	N	3	2	1	36	54	N	7	6	N	4	N	N	1	69	105	8	N	N	5	4	3	N	N	9C	156
N	N	N	N	N	N	3	N	N	04	4	N	N	6	5	N	3	2	1	37	55	N	7	6	N	4	N	2	N	6A	106	8	N	N	5	4	3	N	1	9D	157
N	N	N	N	N	3	N	1	05	5	N	N	6	5	4	N	N	N	38	56	N	7	6	N	4	N	2	1	6B	107	8	N	N	5	4	3	2	N	9E	158	
N	N	N	N	N	3	2	N	06	6	N	N	6	5	4	N	N	1	39	57	N	7	6	N	4	3	N	N	6C	108	8	N	N	5	4	3	2	1	9F	159	
N	N	N	N	N	3	2	1	07	7	N	N	6	5	4	N	2	N	3A	58	N	7	6	N	4	3	N	1	6D	109	8	N	6	N	N	N	N	N	AO	160	
N	N	N	N	4	N	N	N	08	8	N	N	6	5	4	N	2	1	3B	59	N	7	6	N	4	3	2	N	6E	110	8	N	6	N	N	N	N	1	A1	161	
N	N	N	N	4	N	N	1	09	9	N	N	6	5	4	3	N	N	3C	60	N	7	6	N	4	3	2	1	6F	111	8	N	6	N	N	2	N	A2	162		
N	N	N	N	4	N	2	N	0A	10	N	N	6	5	4	3	N	1	3D	61	N	7	6	5	N	N	N	N	70	112	8	N	6	N	N	2	1	A3	163		
N	N	N	N	4	N	2	1	0B	11	N	N	6	5	4	3	2	N	3E	62	N	7	6	5	N	N	N	1	71	113	8	N	6	N	N	3	N	A4	164		
N	N	N	N	4	3	N	N	0C	12	N	N	6	5	4	3	2	1	3F	63	N	7	6	5	N	N	2	N	72	114	8	N	6	N	N	3	N	1	A5	165	
N	N	N	N	4	3	N	1	0D	13	N	7	N	N	N	N	N	N	40	64	N	7	6	5	N	N	2	1	73	115	8	N	6	N	N	3	2	N	Ac	166	
N	N	N	N	4	3	2	N	0E	14	N	7	N	N	N	N	N	1	41	65	N	7	6	5	N	3	N	N	74	116	8	N	6	N	N	3	2	1	A7	167	
N	N	N	N	4	3	2	1	0F	15	N	7	N	N	N	N	2	N	42	66	N	7	6	5	N	3	N	1	75	117	8	N	6	N	4	N	N	A8	168		
N	N	N	5	N	N	N	N	10	16	N	7	N	N	N	N	2	1	43	67	N	7	6	5	N	3	2	N	76	118	8	N	6	N	4	N	N	1	A9	169	
N	N	N	5	N	N	N	1	11	17	N	7	N	N	N	3	N	N	44	68	N	7	6	5	N	3	2	1	77	119	8	N	6	N	4	N	2	N	AA	170	
N	N	N	5	N	N	2	N	12	18	N	7	N	N	N	3	N	1	45	69	N	7	6	5	4	N	N	N	78	120	8	N	6	N	4	N	2	1	AE	171	
N	N	N	5	N	N	2	1	13	19	N	7	N	N	N	3	2	N	46	70	N	7	6	5	4	N	N	1	79	121	8	N	6	N	4	3	N	N	AC	172	
N	N	N	5	N	3	N	N	14	20	N	7	N	N	N	3	2	1	47	71	N	7	6	5	4	N	2	N	7A	122	8	N	6	N	4	3	N	1	AD	173	
N	N	N	5	N	3	N	1	15	21	N	7	N	N	4	N	N	N	48	72	N	7	6	5	4	N	2	1	7B	123	8	N	6	N	4	3	2	N	AE	174	
N	N	N	5	N	3	2	N	16	22	N	7	N	N	4	N	N	1	49	73	N	7	6	5	4	3	N	N	7C	124	8	N	6	N	4	3	2	1	AF	175	
N	N	N	5	N	3	2	1	17	23	N	7	N	N	4	N	2	N	4A	74	N	7	6	5	4	3	N	1	7D	125	8	N	6	5	N	N	N	1	B0	176	
N	N	N	5	4	N	N	N	18	24	N	7	N	N	4	N	2	1	4E	75	N	7	6	5	4	3	2	N	7E	126	8	N	6	5	N	N	N	1	B1	177	
N	N	N	5	4	N	N	1	19	25	N	7	N	N	4	3	N	N	4C	76	N	7	6	5	4	3	2	1	7F	127	8	N	6	5	N	N	2	N	B2	178	
N	N	N	5	4	N	2	N	1A	26	N	7	N	N	4	3	N	1	4D	77	8	N	N	N	N	N	N	N	80	128	8	N	6	5	N	N	2	1	B3	179	
N	N	N	5	4	N	2	1	1B	27	N	7	N	N	4	3	2	N	4E	78	8	N	N	N	N	N	N	1	81	129	8	N	6	5	N	3	N	N	B4	180	
N	N	N	5	4	3	N	N	1C	28	N	7	N	N	4	3	2	1	4F	79	8	N	N	N	N	N	2	N	82	130	8	N	6	5	N	3	N	1	B5	181	
N	N	N	5	4	3	N	1	1D	29	N	7	N	5	N	N	N	N	50	80	8	N	N	N	N	N	2	1	83	131	8	N	6	5	N	3	2	N	B6	182	
N	N	N	5	4	3	2	N	1E	30	N	7	N	5	N	N	N	1	51	81	8	N	N	N	N	3	N	N	84	132	8	N	6	5	N	3	2	1	B7	183	
N	N	N	5	4	3	2	1	1F	31	N	7	N	5	N	N	2	N	52	82	8	N	N	N	N	3	N	1	85	133	8	N	6	5	4	N	N	N	B8	184	
N	N	6	N	N	N	N	N	20	32	N	7	N	5	N	N	2	1	53	83	8	N	N	N	N	3	2	N	86	134	8	N	6	5	4	N	N	1	B9	185	
N	N	6	N	N	N	N	1	21	33	N	7	N	5	N	3	N	N	54	84	8	N	N	N	N	3	2	1	87	135	8	N	6	5	4	N	2	N	BA	186	
N	N	6	N	N	N	2	N	22	34	N	7	N	5	N	3	N	1	55	85	8	N	N	N	4	N	N	N	88	136	8	N	6	5	4	N	2	1	BB	187	
N	N	6	N	N	N	2	1	23	35	N	7	N	5	N	3	2	N	56	86	8	N	N	N	4	N	N	1	89	137	8	N	6	5	4	3	N	N	BC	188	
N	N	6	N	N	3	N	N	24	36	N	7	N	5	N	3	2	1	57	87	8	N	N	N	4	N	2	N	8A	138	8	N	6	5	4	3	N	1	BD	189	
N	N	6	N	N	3	N	1	25	37	N	7	N	5	4	N	N	N	58	88	8	N	N	N	4	N	2	1	8B	139	8	N	6	5	4	3	2	N	BE	190	
N	N	6	N	N	3	2	N	26	38	N	7	N	5	4	N	N	1	59	89	8	N	N	N	4	3	N	N	8C	140	8	N	6	5	4	3	2	1	BF	L91	
N	N	6	N	N	3	2	1	27	38	N	7	N	5	4	N	2	N	5A	90	8	N	N	N	4	3	N	1	8D	141	8	7	N	N	N	N	N	N	CO	192	
N	N	6	N	4	N	N	N	28	40	N	7	N	5	4	N	2	1	5B	91	8	N	N	N	4	3	2	N	8E	142	8	7	N	N	N	N	N	1	C1	193	
N	N	6	N	4	N	N	1	29	41	N	7	N	5	4	3	N	N	5C	92	8	N	N	N	4	3	2	1	8F	143	8	7	N	N	N	N	2	N	C2	194	
N	N	6	N	4	N	2	N	2A	42	N	7	N	5	4	3	N	1	5D	93	8	N	N	5	N	N	N	N	90	144	8	7	N	N	N	N	2	1	C3	195	
N	N	6	N	4	N	2	1	2B	43	N	7	N	5	4	3	2	N	5E	94	8	N	N	5	N	N	N	1	91	145	8	7	N	N	N	3	N	N	C4	196	
N	N	6	N	4	3	N	N	2C	44	N	7	N	5	4	3	2	1	5F	95	8	N	N	5	N	N	2	N	92	146	8	7	N	N	N	3	N	1	C5	197	
N	N	6	N	4	3	N	1	2D	45	N	7	6	N	N	N	N	N	60	96	8	N	N	5	N	N	2	1	93	147	8	7	N	N	N	3	2	N	C6	198	
N	N	6	N	4	3	2	N	2E	46	N	7	6	N	N	N	N	1	61	97	8	N	N	5	N	3	N	N	94	148	8	7	N	N	N	3	2	1	C7	199	
N	N	6	N	4	3	2	1	2F	47	N	7	6	N	N	N	2	N	62	98	8	N	N	5	N	3	N	1	95	149	8	7	N	N	4	N	N	N	C8	200	
N	N	6	5	N	N	N	N	30	48	N	7	6	N	N	N	2	1	63	99	8	N	N	5	N	3	2	N	96	150	8	7	N	N	4	N	N	1	C9	201	
N	N	6	5	N	N	N	1	31	48	N	7	6	N	N	3	N	N	64	100	8	N	N	5	N	3	2	1	97	151	8	7	N	N	4	N	2	N	CA	202	
N	N	6	5	N	N	2	N	32	50	N	7	6	N</																											

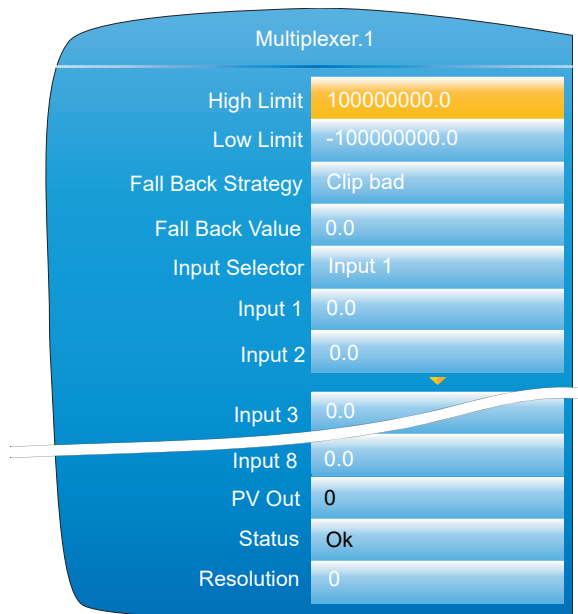

Figure 148 Multiplexer block configuration

Configuration parameters

High Limit	The high limit for input, output and fallback values. Minimum value is Low Limit.
Low Limit	The low limit for input and fallback values. Maximum value is High Limit.
Fallback Strategy	<p>Clip Bad: If the input value is above 'High Limit' or below 'Low Limit', then the output value is set to the appropriate limit, and the status is set to 'Bad'. If the input signal is within the limits, but its status is bad, the output is set to the Fallback value.</p> <p>Clip Good: If the input value is above 'High Limit' or below 'Low Limit', then the output value is set to the appropriate limit, and the status is set to 'Good'. If the input signal is within the limits, but its status is bad, the output is set to the Fallback value.</p> <p>Fall Bad: If the input value is above 'High Limit' or below 'Low Limit', then the output value is set to the Fallback value, and the status is set to 'Bad'</p> <p>Fall Good: If the input value is above 'High Limit' or below 'Low Limit', then the output value is set to the Fallback value, and the status is set to 'Good'</p> <p>Upscale: If the input status is bad, or if the input signal is above 'High Limit' or below 'Low Limit', the output value is set to the High limit.</p> <p>Downscale: If the input status is bad, or if the input signal is above 'High Limit' or below 'Low Limit', the output value is set to the Low limit.</p>
Fallback Value	The value to be adopted by the output, under error conditions, if 'Fallback Status' is set to 'Fall Good' or 'Fall Bad'.
Input Selector	Selects which of the eight inputs is presented at the output. When wired to a suitable parameter, Input Selector becomes read only. Input 1 is selected for an Input Selector value of 1, Input 2 for a value of 2 and so on. Input Selector values greater than 8 are ignored. If not wired, the user may select the required input using the scroll keys.
Input 1 to 8	Wired to the relevant analogue inputs.

Status	Indicates the status of the operation as 'Ok' or 'Error'.
Resolution	The number of decimal places for the output value (maximum = 6).

Math (2 Input)

This 'Toolkit' option block allows one of a number of operations to be carried out using two input values which may be analogue or digital in nature. Either or both of the inputs can be scaled, using a 'Multiplier'.

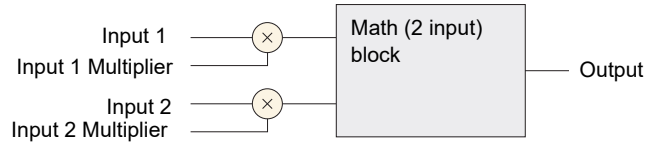

Figure 149 Block schematic

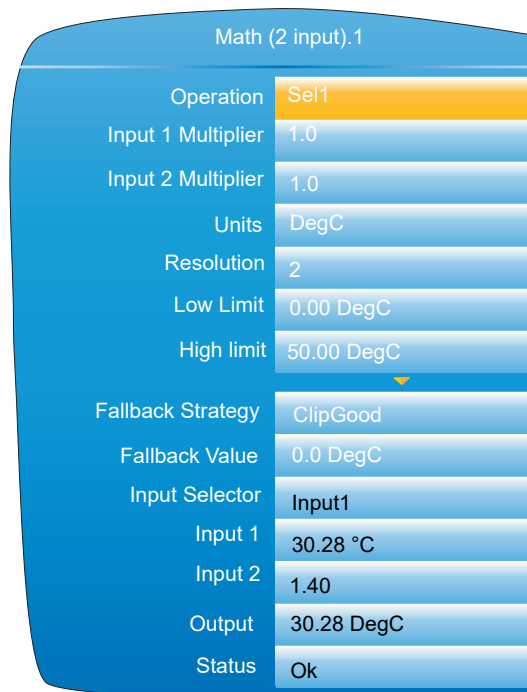

Figure 150 Block configuration (typical)

Parameters

Operation		
Add	Output = Input 1 + Input 2	
Subtract	Output = Input 1 - Input 2	
Multiply	Output = Input 1 x Input 2	
Divide	Output = Input 1 ÷ Input 2	
Abs Diff	Output = the difference between Input 1 and Input 2, ignoring sign	
Select Max	Output = whichever is the larger of Input 1 or Input 2	
Select Min	Output = whichever is the smaller of Input 1 or Input 2	
Hot Swap	Output = Input 2 if Input 1 is 'Bad'; otherwise Output = Input 1	

Sample/Hold	Output tracks Input 1 whilst Input 2 = 1. Output value is held whilst Input 2 = 0 (See Section 6.26.2, below, for more details)
Power*	Output = Input 1 to the power of Input 2. (Output = Input 1 ^{Input 2})
Square Root	Output = Sqrt Input 1 (Input 2 ignored)
Log Base 10	Output = Log ₁₀ Input 1 (Input 2 ignored)
Log Base e	Output = Ln Input 1 (Input 2 ignored)
Exponential	Output = e ^{Input1} (Input 2 ignored)
10 to the X	Output = 10 ^{Input 1} (Input 2 ignored)
Sel1	Output = Input 1 if Input Selector = Input1 Output = Input 2 if Input Selector = Input2

Note: * For this implementation:

0 to the power 0 = 1.

Negative values raised to any power result in bad status.

0 raised to a negative power results in bad status.

Input 1(2) Multiplier	The scaling factor for input 1(2). This multiplying factor is applied to the input of the function, but does not affect the displayed values of Input1 and Input 2 (below).
Units	Allows a five-character string to be entered for the function
Resolution	Sets the number of decimal places for the Output value. Input resolution (if applicable) is that of the relevant input.
High Limit	The high limit for input, output and fallback values. Minimum value is Low Limit.
Low Limit	The low limit for input and fallback values. Maximum value is High Limit.
Fallback Strategy	Clip Bad: If the input value is above 'High Limit' or below 'Low Limit', then the output value is set to the appropriate limit, and the status is set to 'Bad'. If the input signal is within the limits, but its status is bad, the output is set to the Fall Back value. Clip Good: If the input value is above 'High Limit' or below 'Low Limit', then the output value is set to the appropriate limit, and the status is set to 'Good'. If the input signal is within the limits, but its status is bad, the output is set to the Fall Back value. Fall Bad: If the input value is above 'High Limit' or below 'Low Limit', then the output value is set to the Fall Back value, and the status is set to 'Bad' Fall Good: If the input value is above 'High Limit' or below 'Low Limit', then the output value is set to the Fall Back value, and the status is set to 'Good' Upscale: If the input status is bad, or if the input signal is above 'High Limit' or below 'Low Limit', the output value is set to the High limit. Downscale: If the input status is bad, or if the input signal is above 'High Limit' or below 'Low Limit', the output value is set to the Low limit.
Fallback Value	The value to be adopted by the output, under error condi-

Input Selector	For 'Select' operation only. When wired to a suitable parameter, Input Select becomes read only. Input 1 is selected if 'Input Select' = 1; Input 2 is selected if 'Input Select' = 2. Input Select values greater than 2 are ignored. If not wired, the user may select the required input using the scroll keys.
Input 1(2)	Wired to suitable input parameters. Displayed values ignore any input multiplier effects.
Output	Gives the output value for the operation.
Status	Shows the status of the output value, as 'Ok' or 'Error'.

Sample and Hold details

As described above, Output follows Input1 as long as Input 2 is 'High'. When Input 2 goes Low, the output adopts the instantaneous value of Input 1 until Input 2 goes High again. When Input 2 goes high the output jumps to the current value of Input 1 and tracks it until Input 2 goes low.

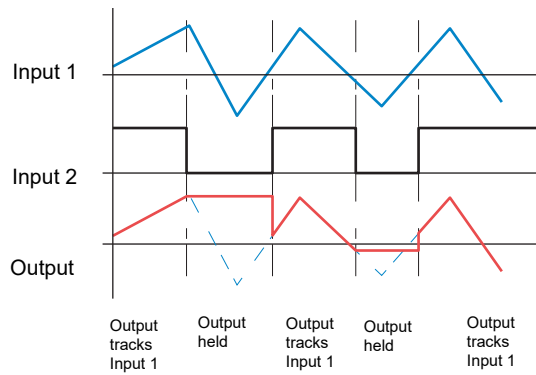

Figure 151 Sample and Hold example

Timer

This 'Toolkit' option allows the user to configure up to four timers as: 'On Pulse', 'On Delay', 'One Shot' or 'Min On' types. The different types are described in "Timer modes" on page 223, below.

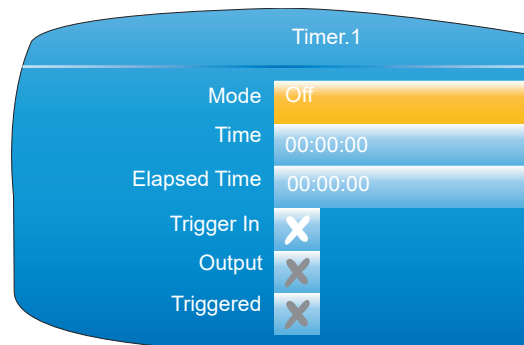

Figure 152 Timer configuration

Parameters

Mode Select 'On pulse', 'On delay', 'One shot' or 'Min On'

Elapsed time	This read-only parameter shows timing progress
Trigger in	Shows if the trigger source is active (tick) or inactive (cross)
Output	Shows if the output is on (tick) or off (cross)
Triggered	Shows if the timer is currently triggered (can remain triggered even after the trigger source has returned to off).

Timer modes

On Pulse

Output goes 'on' as soon as the trigger input goes active, and remains on until the time period has elapsed. If the timer is re-triggered during the timing period, the timer restarts.

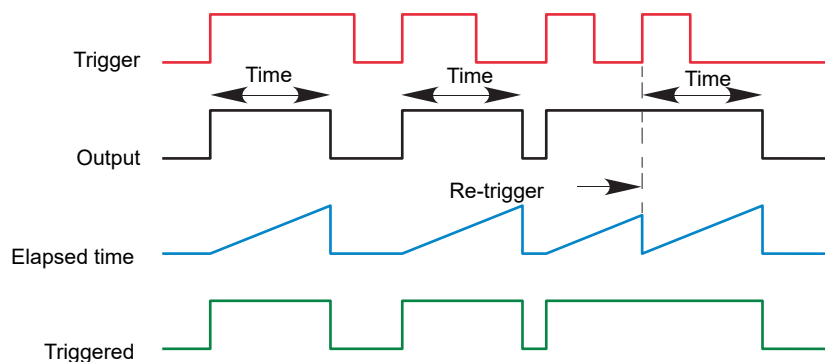

Figure 153 'On Pulse' definitions ON DELAY

Provides a delay between the trigger point and the timer output becoming active.

Rules

1. After the trigger goes active, the output switches on after the delay time has elapsed, and stays on until the trigger goes inactive.
2. If the trigger goes inactive before the delay time has elapsed, the output does not switch on.

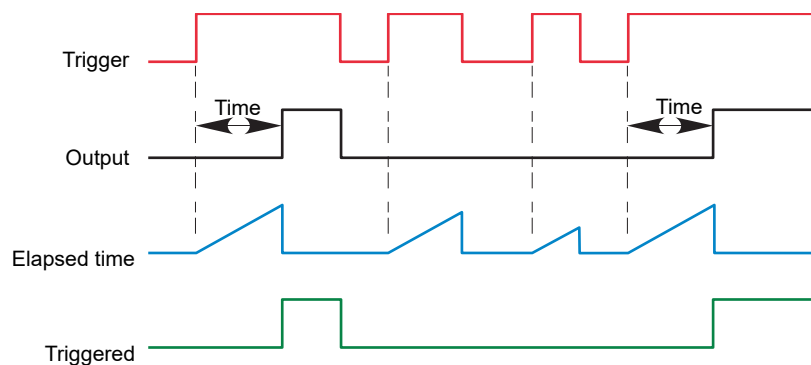

Figure 154 'On Delay' definitions

One Shot

If the trigger input is active, countdown timing is initiated as soon as the entered time value is confirmed (scroll key). The entered time decrements to zero, and must be re-entered by the user before any further timer function can be initiated.

Rules

1. The time value decrements only when the trigger input is active.
2. The output is On only when the trigger value is active (and the entered time value has not elapsed).
3. The entered time value can be edited at any time to increase or decrease the remaining time period.

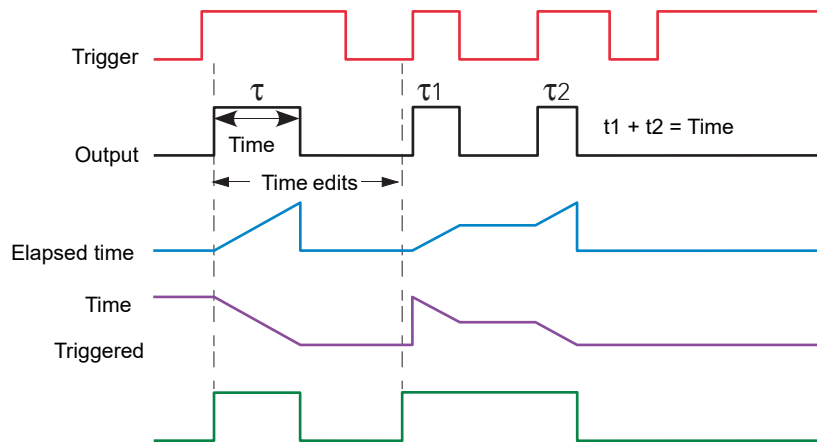

Figure 155 'One Shot' timer definitions

MIN On

Note: For ease of comparison the two time edits in the figure above were both to the same value. This is not a necessary condition.

This 'Off delay' function provides an output signal that goes 'on' when the trigger goes active and remains on for a specified period after the trigger goes inactive.

If the trigger goes inactive, then active again before the time period has elapsed, then the elapsed time is reset to zero and the output remains on.

The 'Triggered' parameter is on whenever the elapsed time is counting down.

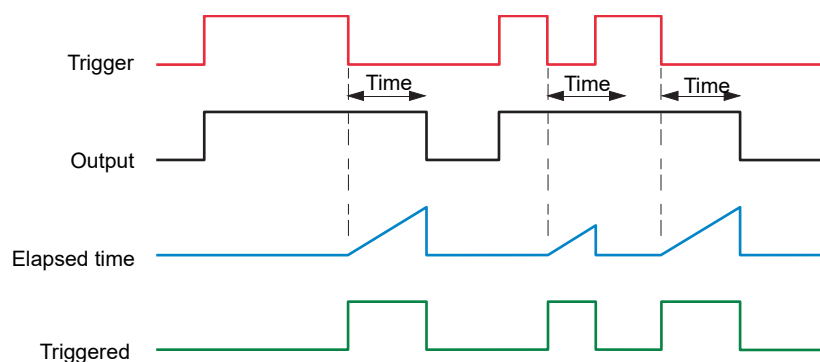

Figure 156 'Min On' timer definitions

User Values

This 'Toolkit' option block allows up to 12 values to be configured for use as inputs to other parameters.

User Value.1	
Units	
Resolution	2
High Limit	100000000.00
Low Limit	-100000000.00
Value	0.00
Status	Ok

Figure 157 User value configuration

Parameters

Units	Allows a five-character string to be entered for the user value units.
Resolution	The number of decimal places for the user value (max. = 6).
High/Low Limit	Sets maximum and minimum values to which the User value can be set.
Value	The user value, either entered manually, or wired to another appropriate parameter.
Status	The output status for the User Value.

Alarm Summary

Allows the user to view the overall status of the unit's alarms, and to carry out a global acknowledgement of active alarms if required.

Global Ack	Allows the user to acknowledge all applicable alarms simultaneously. 'Manual' alarms must be non-active before they can be acknowledged.
Any Channel alarm	Indicates if there are any channel alarms active, acknowledged etc.
Any Sys Alarm	Indicates if there are any active system alarms.
Any Alarm	Indicates if there are any channel or system alarms active.

Alarm Summary.Global	
Global Ack	No
Any Channel Alarm	Yes NAck
Any Sys Alarm	Yes
Any Alarm	Yes

Figure 158 Alarm summary display

Real Time Event Configuration

This allows the user to configure up to two events to trigger at a specific time and date, or on a particular day, and to remain active for a configurable time, either measured as a duration, or as a specific 'Off' time.

Typical applications would be to start and/or stop a programmer at a particular time, or to act as an input to a 'Wait' segment.

Figure 159 shows the two types of timer: 'Time and Day', and 'Time and Date', for Event 1.

Real Time Event.1	
Type	Time and Day
On Day	Mon-Fri
On Time	16:00:00
Off Type	Time
Off day	Monday
Off Time	09:00:00
Output	✘

Real Time Event.1	
Type	Time and Date
On Month	October
On Date	11
On Time	14:50:00
Off Type	Duration
Duration	00:01:00
Output	✘

Figure 159 Real Time Events (typical)

Type	Selects the type of the real time event (Off, Time and Day, Time and Date).
On Month	For 'Time and Date' only, this is the month that the event is to switch on (January, ... December or Every Month). (Every Month was added in software version 5.5).
On Date	For 'Time and Date' only, this is the date in the month that the event is to switch on.
On Day	For 'Time and Day' only, this is the day(s) of the week that the event output is to switch on (Mon, Tue, Wed, Thu, Fri, Sat, Sun, Mon-Fri, Sat-Sun, Everyday).
On Time	The time of day that the event output is to switch on (00:00:00 to 23:59:59)
Off Type	Selects the action that will switch the event off (Duration, Time)
Off Month	For 'Time and Date' only and with 'Off Type' set to 'Time', this is the month that the event is to switch off. (January, ... December or Every Month). (Every Month was added in software version 5.5).
Off Date	For 'Time and Date' only and with 'Off Type' set to 'Time', this is the day number in the month that the event is to switch off.
Off Day	For 'Time and Day' only and with 'Off Type' set to 'Time', this is the day of the week that the event output is to switch off (Mon, Tue, Wed, Thu, Fri, Sat, Sun, Mon-Fri, Sat-Sun, Everyday).
Off Time	The time at which the event output is to switch off (00:00:00 - 23:59:59)
Duration	For 'Off type' set to 'Duration', this specifies the duration for which the event output is to remain on (00:00:01 to 23:59:59 for Time and Day, or 00:00:01 to 500:00:00 for Time and Date)
Output	The output for the real time event (Cross symbol = Off. Tick

MODBUS TCP Slave Comms

Installation

The installation of the Modbus link consists of connecting a standard Ethernet cable between the RJ45 connector at the rear of the unit to a host computer either directly or via a network. A 'straight-through' cable can be used in either case (i.e. a cross-over cable is not required).

Introduction

MODBUS TCP allows the instrument to act as a 'slave' device to one or more host computers connected via the RJ45 connector at the rear of the recorder. Each recorder must have a unique Internet Protocol (IP) address, set up as described in "Termination details" on page 31 (Network.Interface).

MODBUS TCP (Transmission Control Protocol) is a variant of the MODBUS family of communications protocols intended for supervision and control of automated equipment specifically covering the use of MODBUS messaging in an intranet or internet environment, using TCP/IP protocols. Much of the MODBUS detail in this manual is derived from the document openmbus.doc, available at <http://www.modbus.org/default.htm>. The above mentioned document also includes implementation guidelines for users.

Note: The Modbus protocol allows a maximum of 255 data bytes to be read from or written to in one transaction. For this reason, the maximum number of standard (16 bit) registers that can be accessed in one transaction is $255/2 = 127$ and the maximum number of IEEE (32-bit) registers is $127/2 = 63$.

Function Codes

MODBUS function codes 3, 4, 6, 8 and 16, defined in [Figure 160](#), are supported and are fully described in "Parameter List" on page 232, below.

Code	Modbus definition	Description
03	Read holding registers	Reads the binary contents of holding registers. In this implementation codes 3 and 4 are identical in operation.
04	Read input registers	Reads the binary contents of holding registers. In this implementation codes 3 and 4 are identical in operation.
06	Preset single register	Writes a single value to a single register.
08	Diagnostics	Performs a simple loop back test.
16	Preset multiple registers	Writes values to multiple holding registers.

Figure 160 MODBUS Function code definition

Diagnostic Codes

Function code 08, subfunction 00 (Return query data) echoes the query (Loop back).

Exception Codes

MODBUS TCP provides reserved codes used for exceptions. These codes provide error information relating to failed requests. Exceptions are signalled by hex 80 being added to the function code of the request, followed by one of the codes listed in [Figure 161](#).

Code		Modbus definition	Description (see Modbus specification for full details)
Dec	Hex		
01	01	Illegal function	An invalid function code was received
02	02	Illegal Data Address	An invalid data address was received
03	03	Illegal Data Value	An invalid data value was received
04	04	Slave Device Failure	An unrecoverable error occurred in the instrument
09	09	Illegal Sub Function	An invalid sub function was received
10	0A	Gateway path unavailable	Gateway misconfigured or overloaded
11	0B	Gateway target device failed to respond	Device not present on the network

Figure 161 Exception codes

Data types

The following data types are supported:

1. 2's complement signed 16-bit analogue values with implied decimal point. The decimal point position must be configured in both the recorder and the host computer.
2. 16, 32 and 64 bit signed integers.
3. 16-bit unsigned integer values.
4. 32 bit IEEE Floating point values.
5. Strings of limited size, can be transferred across Modbus TCP in Unicode format using a single non-multiplexed set of consecutive registers.

Data Encoding

MODBUS uses what is called a 'Big endian' representation for addresses and data items. This means that when a numerical quantity larger than a single byte is transmitted, the most significant byte is sent first. For example a 32-bit hex value of 12345678 would be transmitted as 12, followed by 34, followed by 56 and finally 78.

Invalid multiple register writes

When a recorder receives a multi-register write request, it is possible that one or more requests will be rejected. Under such a circumstance, the recorder accepts all valid write requests and ignores any invalid writes. No error response is produced.

Master communications timeout

Whilst the instrument is archiving, it is possible that communications responses slow sufficiently to cause communications timeouts. The Modbus master device should be configured with a timeout value large enough to ensure against nuisance timeouts during archiving.

Non-volatile parameters in EEPROM

CAUTION

INOPERABLE EQUIPMENT

The parameters in the following list must not be written-to on a continuous basis.

Failure to follow these instructions can result in injury or equipment damage.

If the parameters are continuously written-to, the EEPROM eventually wears out and become unserviceable.

AdvancedLoop.MasterPID.ControlAction	AdvancedLoop.SlaveSP.RangeHigh	DigitalIO.2A2B.StandbyAction
AdvancedLoop.MasterPID.CutbackHigh	AdvancedLoop.SlaveSP.RangeLow	DigitalIO.2A2B.Type
AdvancedLoop.MasterPID.CutbackLow	AdvancedLoop.SlaveSP.SbrkSP	DigitalIO.3A3B.Backlash
AdvancedLoop.MasterPID.DerivativeTime	AdvancedLoop.Tune.Band	DigitalIO.3A3B.Inertia
AdvancedLoop.MasterPID.DerivativeType	AdvancedLoop.Tune.CycleNo	DigitalIO.3A3B.Invert
AdvancedLoop.MasterPID.ErrorLimit	AdvancedLoop.Tune.Hysteresis	DigitalIO.3A3B.MinOnTime
AdvancedLoop.MasterPID.IntegralTime	AdvancedLoop.Tune.OutputHighLimit	DigitalIO.3A3B.StandbyAction
AdvancedLoop.MasterPID.LoopBreakTime	AdvancedLoop.Tune.OutputLowLimit	DigitalIO.3A3B.Type
AdvancedLoop.MasterPID.ManualReset	AdvancedLoop.Tune.PBs	DigitalIO.DI_LALC.Backlash
AdvancedLoop.MasterPID.PBUnits	AdvancedLoop.Tune.Settle	DigitalIO.DI_LALC.Inertia
AdvancedLoop.MasterPID.ProportionalBand	AdvancedLoop.Tune.TDs	DigitalIO.DI_LALC.Invert
AdvancedLoop.MasterSP.ManualTrack	AdvancedLoop.Tune.Timeout	DigitalIO.DI_LALC.MinOnTime
AdvancedLoop.MasterSP.RangeHigh	AdvancedLoop.Tune.TuneHigh	DigitalIO.DI_LALC.StandbyAction
AdvancedLoop.MasterSP.RangeLow	AdvancedLoop.Tune.TuneLow	DigitalIO.DI_LALC.Type
AdvancedLoop.MasterSP.ServoToPV	AdvancedLoop.Tune.TuneR2G	DigitalIO.DI_LBLC.Backlash
AdvancedLoop.MasterSP.SPHighLimit	AdvancedLoop.Tune.TuneType	DigitalIO.DI_LBLC.Inertia
AdvancedLoop.MasterSP.SPIntBal	BCDInput.N.InN	DigitalIO.DI_LBLC.Invert
AdvancedLoop.MasterSP.SPLowLimit	BCDInput.N.SettleTime	DigitalIO.DI_LBLC.MinOnTime
AdvancedLoop.MasterSP.SPTrack	Channel.N.AlarmN.Amount	DigitalIO.DI_LBLC.StandbyAction
AdvancedLoop.MasterSP.SPTrimHighLimit	Channel.N.AlarmN.AverageTime	DigitalIO.DI_LBLC.Type
AdvancedLoop.MasterSP.SPTrimLowLimit	Channel.N.AlarmN.Block	DigitalIO.RELAY_4AC.Backlash
AdvancedLoop.Output.Ch1OnOffHysteresis	Channel.N.AlarmN.ChangeTime	DigitalIO.RELAY_4AC.Inertia
AdvancedLoop.Output.Ch1TravelTime	Channel.N.AlarmN.Deviation	DigitalIO.RELAY_4AC.Invert
AdvancedLoop.Output.Ch2Deadband	Channel.N.AlarmN.Dwell	DigitalIO.RELAY_4AC.MinOnTime
AdvancedLoop.Output.Ch2OnOffHysteresis	Channel.N.AlarmN.Hysteresis	DigitalIO.RELAY_4AC.StandbyAction
AdvancedLoop.Output.Ch2TravelTime	Channel.N.AlarmN.Latch	DigitalIO.RELAY_4AC.Type
AdvancedLoop.Output.CoolType	Channel.N.AlarmN.Threshold	DigitalIO.RELAY_5AC.Backlash
AdvancedLoop.Output.EnablePowerFeedforward	Channel.N.AlarmN.Type	DigitalIO.RELAY_5AC.Inertia
AdvancedLoop.Output.FeedForwardGain	Channel.N.Main.CJType	DigitalIO.RELAY_5AC.Invert
AdvancedLoop.Output.FeedForwardOffset	Channel.N.Main.CloseString	DigitalIO.RELAY_5AC.MinOnTime
AdvancedLoop.Output.FeedForwardTrimLimit	Channel.N.Main.Descriptor	DigitalIO.RELAY_5AC.StandbyAction
AdvancedLoop.Output.FeedForwardType	Channel.N.Main.ExtCJTemp	DigitalIO.RELAY_5AC.Type
AdvancedLoop.Output.ManualMode	Channel.N.Main.FaultResponse	EthernetIP.ImplicitInputs.InputN
AdvancedLoop.Output.ManualStartup	Channel.N.Main.Filter	EthernetIP.ImplicitOutputs.OutputN
AdvancedLoop.Output.OutputHighLimit	Channel.N.Main.InputHigh	EthernetIP.InputTags.InputN
AdvancedLoop.Output.OutputLowLimit	Channel.N.Main.InputLow	EthernetIP.Main.ConfigInstance
AdvancedLoop.Output.PotBreakMode	Channel.N.Main.LinType	EthernetIP.Main.ConfigSize
AdvancedLoop.Output.Rate	Channel.N.Main.Offset	EthernetIP.Main.ConnectionType
AdvancedLoop.Output.RateDisable	Channel.N.Main.Offset2	EthernetIP.Main.InputInstance
AdvancedLoop.Output.SafeOutVal	Channel.N.Main.OpenString	EthernetIP.Main.InputSize
AdvancedLoop.Output.SbrkOP	Channel.N.Main.RangeHigh	EthernetIP.Main.Mode
AdvancedLoop.Output.SlaveSensorBreak-Mode	Channel.N.Main.RangeLow	EthernetIP.Main.OutputInstance
AdvancedLoop.Setup.CascadeType	Channel.N.Main.RangeUnits	EthernetIP.Main.OutputSize
AdvancedLoop.Setup.ManOutputAccess	Channel.N.Main.Resolution	EthernetIP.Main.Priority
AdvancedLoop.Setup.MasterName	Channel.N.Main.ScaleHigh	EthernetIP.Main.Rpi
AdvancedLoop.Setup.ModeAccess	Channel.N.Main.ScaleHigh2	EthernetIP.Main.ServerAddress
AdvancedLoop.Setup.SetpointAccess	Channel.N.Main.ScaleLow	EthernetIP.Main.SlotNumber
AdvancedLoop.Setup.SlaveChannel1	Channel.N.Main.ScaleLow2	EthernetIP.OutputTags.OutputN
AdvancedLoop.Setup.SlaveChannel2	Channel.N.Main.SensorBreakType	EthernetIP.OutputTags.Output2
AdvancedLoop.Setup.SlaveName	Channel.N.Main.Shunt	Group.Recording.ChannelNEn
AdvancedLoop.SlavePID.Boundary1-2	Channel.N.Main.TestSignal	Group.Recording.Compression
AdvancedLoop.SlavePID.Boundary2-3	Channel.N.Main.Type	Group.Recording.Enable
AdvancedLoop.SlavePID.ControlAction	Channel.N.Main.Units	Group.Recording.Interval
AdvancedLoop.SlavePID.CutbackHigh	Channel.N.Trend.Colour	Group.Recording.VirtualChanNEn
AdvancedLoop.SlavePID.CutbackHigh2	Channel.N.Trend.SpanHigh	Group.Recording.VirtualChan28En
AdvancedLoop.SlavePID.CutbackHigh3	Channel.N.Trend.SpanLow	Group.Trend.Descriptor
AdvancedLoop.SlavePID.CutbackLow	CustomMessage.MessageN	Group.Trend.Interval
AdvancedLoop.SlavePID.CutbackLow2	DCOutput.1A1B_DCOP.FallbackPV	Group.Trend.MajorDivisions
AdvancedLoop.SlavePID.CutbackLow3	DCOutput.1A1B_DCOP.OutputHigh	Group.Trend.PointN
AdvancedLoop.SlavePID.DerivativeTime	DCOutput.1A1B_DCOP.OutputLow	Humidity.Pressure
AdvancedLoop.SlavePID.DerivativeTime2	DCOutput.1A1B_DCOP.Resolution	Humidity.PsychroConst
AdvancedLoop.SlavePID.DerivativeTime3	DCOutput.1A1B_DCOP.ScaleHigh	Humidity.Resolution
AdvancedLoop.SlavePID.DerivativeType	DCOutput.1A1B_DCOP.ScaleLow	Humidity.WetOffset
AdvancedLoop.SlavePID.IntegralTime	DCOutput.1A1B_DCOP.Type	Instrument.Display.AlarmPanel
AdvancedLoop.SlavePID.IntegralTime2	DCOutput.2A2B_DCOP.FallbackPV	Instrument.Display.Brightness
AdvancedLoop.SlavePID.IntegralTime3	DCOutput.2A2B_DCOP.OutputHigh	Instrument.Display.Cascade
AdvancedLoop.SlavePID.LoopBreakTime	DCOutput.2A2B_DCOP.OutputLow	Instrument.Display.DualLoopControl
AdvancedLoop.SlavePID.LoopBreakTime2	DCOutput.2A2B_DCOP.Resolution	Instrument.Display.EIPServerPage
AdvancedLoop.SlavePID.LoopBreakTime3	DCOutput.2A2B_DCOP.ScaleHigh	Instrument.Display.FutureTrend
AdvancedLoop.SlavePID.ManualReset	DCOutput.2A2B_DCOP.ScaleLow	Instrument.Display.FutureTrend1Colour
AdvancedLoop.SlavePID.ManualReset2	DCOutput.2A2B_DCOP.Type	Instrument.Display.FutureTrend2Colour
AdvancedLoop.SlavePID.ManualReset3	DCOutput.3A3B_DCOP.FallbackPV	Instrument.Display.HistoryBackground
AdvancedLoop.SlavePID.NumberOfSets	DCOutput.3A3B_DCOP.OutputHigh	Instrument.Display.HomePage
AdvancedLoop.SlavePID.PBUnits	DCOutput.3A3B_DCOP.OutputLow	Instrument.Display.HorizontalBar
AdvancedLoop.SlavePID.ProportionalBand	DCOutput.3A3B_DCOP.Resolution	Instrument.Display.HorizontalTrend
AdvancedLoop.SlavePID.ProportionalBand2	DCOutput.3A3B_DCOP.ScaleHigh	Instrument.Display.HPageTimeout
AdvancedLoop.SlavePID.ProportionalBand3	DCOutput.3A3B_DCOP.ScaleLow	Instrument.Display.HTrendScaling
AdvancedLoop.SlavePID.RelCh2Gain	DCOutput.3A3B_DCOP.Type	Instrument.Display.LoopControl
AdvancedLoop.SlavePID.RelCh2Gain2	DigitalIO.1A1B.Backlash	Instrument.Display.LoopSetpointColour
AdvancedLoop.SlavePID.RelCh2Gain3	DigitalIO.1A1B.Inertia	Instrument.Display.ModbusMaster
AdvancedLoop.SlavePID.RemotelyInput	DigitalIO.1A1B.Invert	Instrument.Display.NumberFormat
AdvancedLoop.SlavePID.SchedulerType	DigitalIO.1A1B.MinOnTime	
AdvancedLoop.SlaveSP.FFSelect	DigitalIO.1A1B.StandbyAction	
AdvancedLoop.SlaveSP.ManualTrack	DigitalIO.1A1B.Type	
AdvancedLoop.SlaveSP.MasterSensorBreak-Mode	DigitalIO.2A2B.Backlash	
	DigitalIO.2A2B.Inertia	
	DigitalIO.2A2B.Invert	
	DigitalIO.2A2B.MinOnTime	

Instrument.Display.Numeric
Instrument.Display.Programmer
Instrument.Display.PromoteListView
Instrument.Display.ScreenSaverAfter
Instrument.Display.ScreenSaverBrightness
Instrument.Display.SteriliserPage
Instrument.Display.TrendBackground
Instrument.Display.USBAutoScan
Instrument.Display.VerticalBar
Instrument.Display.VerticalTrend
Instrument.Info.CloneState
Instrument.Info.Name
Instrument.Locale.DateFormat
Instrument.Locale.DSTenable
Instrument.Locale.EndDay
Instrument.Locale.EndMonth
Instrument.Locale.EndOn
Instrument.Locale.EndTime
Instrument.Locale.Language
Instrument.Locale.StartDay
Instrument.Locale.StartMonth
Instrument.Locale.StartOn
Instrument.Locale.StartTime
Instrument.Locale.TimeZone
Instrument.Notes.NoteN
Instrument.PromoteList.PromoteListName
Instrument.PromoteList.PromoteParamN
Instrument.PromoteList.PromoteParamNDesc
Instrument.OEMConfigList.ParameterN
Instrument.OEMSupervisorList.ParameterN
Instrument.Security.CommsPass
Instrument.Security.DefaultConfig
Instrument.Security.EngineerPassword
Instrument.Security.OEMParamLists
Instrument.Security.OEMPass
Instrument.Security.OperatorPassword
Instrument.Security.SupervisorPassword
Lgc2.N.FallbackType
Lgc2.N.In1
Lgc2.N.In2
Lgc2.N.Invert
Lgc2.N.Oper
Lgc8.N.InN
Lgc8.N.InInvert
Lgc8.N.NumIn
Lgc8.N.Oper
Lgc8.N.OutInvert
Loop.N.Diag.LoopMode
Loop.N.OP.Ch1OnOffHysteresis
Loop.N.OP.Ch1TravelTime
Loop.N.OP.Ch2Deadband
Loop.N.OP.Ch2OnOffHysteresis
Loop.N.OP.Ch2TravelTime
Loop.N.OP.CoolType
Loop.N.OP.EnablePowerFeedforward
Loop.N.OP.FeedForwardGain
Loop.N.OP.FeedForwardOffset
Loop.N.OP.FeedForwardTrimLimit
Loop.N.OP.FeedForwardType
Loop.N.OP.ManStartup
Loop.N.OP.ManualMode
Loop.N.OP.OutputHighLimit
Loop.N.OP.OutputLowLimit
Loop.N.OP.PotBreakMode
Loop.N.OP.Rate
Loop.N.OP.RateDisable
Loop.N.OP.SafeOutVal
Loop.N.OP.SbrkOP
Loop.N.OP.SensorBreakMode
Loop.N.PID.Boundary1-2
Loop.N.PID.Boundary2-3
Loop.N.PID.CutbackHigh
Loop.N.PID.CutbackHighN
Loop.N.PID.CutbackLow
Loop.N.PID.CutbackLowN
Loop.N.PID.DerivativeTime
Loop.N.PID.DerivativeTimeN
Loop.N.PID.IntegralTime
Loop.N.PID.IntegralTimeN
Loop.N.PID.LoopBreakTime
Loop.N.PID.LoopBreakTimeN
Loop.N.PID.ManualReset
Loop.N.PID.ManualResetN
Loop.N.PID.NumSets
Loop.N.PID.ProportionalBand
Loop.N.PID.ProportionalBandN
Loop.N.PID.RelCh2Gain
Loop.N.PID.RelCh2GainN
Loop.N.PID.SchedulerRemoteInput
Loop.N.PID.SchedulerType
Loop.N.Setup.AutoManAccess
Loop.N.Setup.CH1ControlType
Loop.N.Setup.CH2ControlType
Loop.N.Setup.ControlAction
Loop.N.Setup.DerivativeType
Loop.N.Setup.LoopName
Loop.N.Setup.ManOutputAccess
Loop.N.Setup.PBUnits
Loop.N.Setup.SPAccess
Loop.N.SP.ManualTrack
Loop.N.SP.RangeHigh
Loop.N.SP.RangeLow
Loop.N.SP.ServoToPV
Loop.N.SP.SPHighLimit
Loop.N.SP.SPIntBal
Loop.N.SP.SPLowLimit
Loop.N.SP.SPTrack
Loop.N.SP.SPTTrimHighLimit
Loop.N.SP.SPTTrimLowLimit
Loop.N.Tune.CycleNo
Loop.N.Tune.Diagnostics
Loop.N.Tune.OutputHighLimit
Loop.N.Tune.OutputLowLimit
Loop.N.Tune.PBs
Loop.N.Tune.Settle
Loop.N.Tune.TDs
Loop.N.Tune.TuneR2G
Loop.N.Tune.Type
Math2.N.Fallback
Math2.N.FallbackVal
Math2.N.HighLimit
Math2.N.InN
Math2.N.InNMul
Math2.N.LowLimit
Math2.N.Oper
Math2.N.Resolution
Math2.N.Select
Math2.N.Units
ModbusMaster.N.Data.BitPosition
ModbusMaster.N.Data.DataType
ModbusMaster.N.Data.Descriptor
ModbusMaster.N.Data.FallbackValue
ModbusMaster.N.Data.FunctionCode
ModbusMaster.N.Data.ModbusAddress
ModbusMaster.N.Data.Mode
ModbusMaster.N.Data.Number
ModbusMaster.N.Data.ParameterList
ModbusMaster.N.Data.Priority
ModbusMaster.N.Data.Scaling
ModbusMaster.N.Data.Set
ModbusMaster.N.Data.SlaveDevice
ModbusMaster.N.Data.Value
ModbusMaster.SlaveN.Data.BitPosition
ModbusMaster.SlaveN.Data.DataType
ModbusMaster.SlaveN.Data.Descriptor
ModbusMaster.SlaveN.Data.FallbackValue
ModbusMaster.SlaveN.Data.FunctionCode
ModbusMaster.SlaveN.Data.ModbusAddress
ModbusMaster.SlaveN.Data.Mode
ModbusMaster.SlaveN.Data.Number
ModbusMaster.SlaveN.Data.ParameterList
ModbusMaster.SlaveN.Data.Priority
ModbusMaster.SlaveN.Data.Scaling
ModbusMaster.SlaveN.Data.Set
ModbusMaster.SlaveN.Data.SlaveDevice
ModbusMaster.SlaveN.Data.Value
ModbusMaster.SlaveN.Main.Descriptor
ModbusMaster.SlaveN.Main.HighPriority
ModbusMaster.SlaveN.Main.IPAAddress
ModbusMaster.SlaveN.Main.LowPriority
ModbusMaster.SlaveN.Main.MaxBlockSize
ModbusMaster.SlaveN.Main.MediumPriority
ModbusMaster.SlaveN.Main.Online
ModbusMaster.SlaveN.Main.Profile
ModbusMaster.SlaveN.Main.Retries
ModbusMaster.SlaveN.Main.Timeout
ModbusMaster.SlaveN.Main.UnitId
Mux8.N.Fallback
Mux8.N.FallbackVal
Mux8.N.HighLimit
Mux8.N.InN
Mux8.N.LowLimit
Mux8.N.Select
Network.Archive.ArchiveRate
Network.Archive.CSVDateFormat
Network.Archive.CSVHeaders
Network.Archive.CSVHeadings
Network.Archive.CSVIncludeValues
Network.Archive.CSVMessages
Network.Archive.CSVTabDelimiter
Network.Archive.Destination
Network.Archive.FileFormat
Network.Archive.OnFull
Network.Archive.Period
Network.Archive.PrimaryPassword
Network.Archive.PrimaryUser
Network.Archive.PServerIPAddress
Network.Archive.RemotePath
Network.Archive.SecondaryPassword
Network.Archive.SecondaryUser
Network.Archive.SServerIPAddress
Network.Archive.FTPserver.Password
Network.Archive.FTPserver.Username
Network.Interface.DNSserver
Network.Interface.Gateway
Network.Interface.IPAaddress
Network.Interface.IPType
Network.Interface.SubnetMask
Network.Modbus.Address
Network.Modbus.InputTimeout
Network.Modbus.PrefMasterIP
Network.Modbus.SerialMode
Network.Modbus.TimeFormat
Network.Modbus.UnitIdEnable
Program.ChNHoldback
Program.ChNHoldbackVal
Program.ChNRampUnits
Program.HoldbackStyle
Program.RampStyle
Programmer.Features.FTPStore
Programmer.Features.Holdback
Programmer.Features.Messages
Programmer.Features.PVEEvents
Programmer.Features.UserValue
Programmer.FTP.IPAAddress
Programmer.FTP.Password
Programmer.FTP.Username
Programmer.Setup.ChNHResolution
Programmer.Setup.ChNServoTo
Programmer.Setup.ChNUnits
Programmer.Setup.Channels
Programmer.Setup.MaxEvents
Programmer.Setup.PowerFailAction
Programmer.Setup.ProgEditAccess
Programmer.Setup.ProgModeAccess
Programmer.Setup.ProgNum
Programmer.Setup.ProgStoreAccess
Programmer.Setup.RateResolution
Programmer.Setup.ResetCh1UserVal
Programmer.Setup.ResetCh2UserVal
Programmer.Setup.ResetEventN
RealTimeEvent.N.Duration
RealTimeEvent.N.OffDate
RealTimeEvent.N.OffDay
RealTimeEvent.N.OffMonth
RealTimeEvent.N.OffTime
RealTimeEvent.N.OffType
RealTimeEvent.N.OnDate
RealTimeEvent.N.OnDay
RealTimeEvent.N.OnMonth
RealTimeEvent.N.OnTime
RealTimeEvent.N.Type
Segment.N.ChNHoldback
Segment.N.ChNHoldbackVal
Segment.N.ChNPVEvent
Segment.N.ChNPVEventUse
Segment.N.ChNPVEventVal
Segment.N.ChNRate
Segment.N.ChNTime
Segment.N.ChNTSP
Segment.N.ChNUserVal
Segment.N.ChNWait
Segment.N.ChNWaitVal
Segment.N.Cycles
Segment.N.Duration
Segment.N.EndType
Segment.N.EventN
Segment.N.GoBackTo
Segment.N.SegmentName
Segment.N.Type
Segment.N.WaitFor

Steriliser.AutoCounter	VirtualChannel.N.AlarmN.Block	Zirconia.GasRef
Steriliser.FailureDwellN	VirtualChannel.N.AlarmN.ChangeTime	Zirconia.GasRefs.CO_Ideal
Steriliser.FileByTag	VirtualChannel.N.AlarmN.Deviation	Zirconia.GasRefs.CO_Local
Steriliser.FileTag	VirtualChannel.N.AlarmN.Dwell	Zirconia.GasRefs.CO_RemoteEn
Steriliser.InputNPV	VirtualChannel.N.AlarmN.Hysteresis	Zirconia.GasRefs.H2_Local
Steriliser.InputTypeN	VirtualChannel.N.AlarmN.Latch	Zirconia.GasRefs.H2_RemoteEn
Steriliser.IP1BandHigh	VirtualChannel.N.AlarmN.Threshold	Zirconia.MaxRcovTime
Steriliser.IP1BandLow	VirtualChannel.N.AlarmN.Type	Zirconia.MinCalTemp
Steriliser.IP1TargetSP	VirtualChannel.N.Main.Descriptor	Zirconia.MinRcovTime
Steriliser.IP2BandHigh	VirtualChannel.N.Main.HighCutOff	Zirconia.NumResolution
Steriliser.IP2BandLow	VirtualChannel.N.Main.LowCutOff	Zirconia.OxygenExp
Steriliser.IP2TargetSP	VirtualChannel.N.Main.Operation	Zirconia.OxygenType
Steriliser.IP3BandHigh	VirtualChannel.N.Main.Period	Zirconia.ProbeOffset
Steriliser.IP3BandLow	VirtualChannel.N.Main.PresetValue	Zirconia.ProbeType
Steriliser.IP3TargetSP	VirtualChannel.N.Main.Resolution	Zirconia.ProcFactor
Steriliser.IP4BandHigh	VirtualChannel.N.Main.RolloverValue	Zirconia.RemGasEn
Steriliser.IP4BandLow	VirtualChannel.N.Main.Type	Zirconia.TempOffset
Steriliser.IP4TargetSP	VirtualChannel.N.Main.Units	Zirconia.Tolerance
Steriliser.LowLimit	VirtualChannel.N.Main.UnitsScaler	
Steriliser.MeasuredTemp	VirtualChannel.N.Trend.Colour	
Steriliser.TargetTemperature	VirtualChannel.N.Trend.SpanHigh	
Steriliser.TargetTime	VirtualChannel.N.Trend.SpanLow	
Steriliser.TargetTime121	WebServer.Enabled	
Steriliser.TargetTime134	WebServer.Password	
Steriliser.ZTemperatureInterval	WebServer.Port	
Timer.N.In	WebServer.Security	
Timer.N.Type	WebServer.Username	
UserLin.N.NumberOfBreakpoints	Zirconia.Clean.CleanEnable	
UserLin.N.XN	Zirconia.Clean.CleanFreq	
UsrVal.N.HighLimit	Zirconia.Clean.CleanMaxTemp	
UsrVal.N.LowLimit	Zirconia.Clean.CleanTime	
UsrVal.N.Resolution	Zirconia.Clean.MaxRcovTime	
UsrVal.N.Units	Zirconia.Clean.MinRcovTime	
VirtualChannel.N.AlarmN.Amount	Zirconia.CleanFreq	
VirtualChannel.N.AlarmN.AverageTime	Zirconia.CleanTime	

Parameter List

This list is arranged in alphabetical block order and gives the memory address for each parameter in both hex and decimal.

The Modbus addresses, in the range 0x0001 -0x3FFF, listed in the table below give access to the parameter values in a scaled integer format. It is possible to gain access to the parameter values in native format by using the following formula:

$$\text{Native address} = (\text{scaled integer address} \times 2) + 0x8000$$

The blocks are ordered as follows:

Advanced Loop	Loop 1	User Lin 3	Virtual chan 15
Alarm summary	Loop 2	User Lin 4	Virtual chan 16
Batch	Mass Flow	User values	Virtual chan 17
BCD Input	Math (2 input)	Virtual chan 1	Virtual chan 18
Channel 1	Modbus Master	Virtual chan 2	Virtual chan 19
Channel 2	Multiplexer	Virtual chan 3	Virtual chan 20
Channel 3	Network	Virtual chan 4	Virtual chan 21
Channel 4	OR block	Virtual chan 5	Virtual chan 22
Custom messages	Program	Virtual chan 6	Virtual chan 23
DC Output	Programmer	Virtual chan 7	Virtual chan 24
Digital I/O	Real Time Events	Virtual chan 8	Virtual chan 25
EtherNet/IP	Saturated Steam	Virtual chan 9	Virtual chan 26
Group	Segments	Virtual chan 10	Virtual chan 27
Humidity	Steriliser	Virtual chan 11	Virtual chan 28
Instrument	Timer	Virtual chan 12	Virtual chan 29
Logic (2 Input)	User Lin 1	Virtual chan 13	Virtual chan 30
Logic (8 input)	User Lin 2	Virtual chan 14	Zirconia

Parameter path	Description	Type	Hex	Dec	Resolution
AdvancedLoop.Diag.CalcOP	Calc OP	float32	031f	799	1dp
AdvancedLoop.Diag.HiSatLim	HiSatLim	float32	0320	800	1dp
AdvancedLoop.Diag.LoSatLim	LoSatLim	float32	0321	801	1dp
AdvancedLoop.Diag.MasterDerivativeOutContrib	Master derivative output contribution	float32	0312	786	0dp
AdvancedLoop.Diag.MasterError	Master error	float32	030d	781	Same as AdvancedLoop.Main.MasterPV
AdvancedLoop.Diag.MasterFB	Master feedback	float32	031e	798	1dp
AdvancedLoop.Diag.MasterIntegralOutContrib	Master integral output contribution	float32	0311	785	4dp
AdvancedLoop.Diag.MasterLoopBreakAlarm	Master loop break (0 = No; 1 = Yes)	bool	0323	803	Not applicable
AdvancedLoop.Diag.MasterPropOutContrib	Master loop proportional output contribution	float32	0310	784	0dp
AdvancedLoop.Diag.MasterSensorBreak	Master sensor break (0 = Off, 1 = On)	bool	0313	787	Not applicable
AdvancedLoop.Diag.OPPID	OPPID	float32	0322	802	1dp
AdvancedLoop.Diag.SchedCBH	Scheduled cutback high	float32	3195	12693	0dp
AdvancedLoop.Diag.SchedCBL	Scheduled cutback low	float32	3196	12694	0dp
AdvancedLoop.Diag.SchedLPBrk	Scheduled loop break time	float32	3198	12696	0dp
AdvancedLoop.Diag.SchedMR	Scheduled manual reset	float32	3197	12695	1dp
AdvancedLoop.Diag.SchedOutputHigh	Scheduled output high limit	float32	319a	12698	1dp
AdvancedLoop.Diag.SchedOutputLow	Scheduled output low limit	float32	319b	12699	1dp
AdvancedLoop.Diag.SchedPB	Scheduled proportional band	float32	3192	12690	1dp
AdvancedLoop.Diag.SchedR2G	Scheduled relative cool gain	float32	3199	12697	1dp
AdvancedLoop.Diag.SchedTd	Scheduled derivative time	float32	3194	12692	1dp
AdvancedLoop.Diag.SchedTi	Scheduled integral time	float32	3193	12691	1dp
AdvancedLoop.Diag.SlaveDerivativeOutContrib	Slave derivative output contribution	float32	031d	797	0dp
AdvancedLoop.Diag.SlaveError	Slave error	float32	031a	794	Same as AdvancedLoop.Main.SlavePV
AdvancedLoop.Diag.SlaveIntegralOutContrib	Slave integral output contribution	float32	031c	796	4dp
AdvancedLoop.Diag.SlaveLoopBreakAlarm	Slave loop break (0 = No; 1 = Yes)	bool	030f	783	Not applicable
AdvancedLoop.Diag.SlavePropOutContrib	Slave loop proportional output contribution	float32	031b	795	0dp
AdvancedLoop.Diag.SlaveSensorBreak	Slave sensor break (0 = Off; 1 = On)	bool	0325	805	Not applicable
AdvancedLoop.Diag.TargetOutput	Target output	float32	030e	782	Same as AdvancedLoop.Output.OutputHighLimit
AdvancedLoop.Diag.WorkingOutputHigh	Slave output high limit	float32	0315	789	0dp
AdvancedLoop.Diag.WorkingOutputLow	Slave output low limit	float32	0314	788	0dp
AdvancedLoop.Main.ActiveOut	Working output	float32	0303	771	Same as AdvancedLoop.Output.OutputHighLimit
AdvancedLoop.Main.CascadeMode	Cascade mode (0 = Cascade; 1 = Slave; 2 = Manual)	uint8	0316	790	Not applicable
AdvancedLoop.Main.Inhibit	Control inhibit (0 = No; 1 = Yes)	bool	0304	772	Not applicable
AdvancedLoop.Main.MasterIntHold	Master integral hold (0 = No; 1 = Yes)	uint8	0305	773	Not applicable
AdvancedLoop.Main.MasterPV	Master loop process variable	float32	0317	791	1dp
AdvancedLoop.Main.MasterWSP	Master loop working setpoint	float32	0318	792	Same as AdvancedLoop.Main.MasterPV
AdvancedLoop.Main.SlaveIntHold	Slave integral hold (0 = No; 1 = Yes)	uint8	0306	774	Not applicable
AdvancedLoop.Main.SlavePV	Slave loop process variable	float32	0300	768	1dp
AdvancedLoop.Main.SlaveWSP	Slave loop working setpoint	float32	0302	770	Same as AdvancedLoop.Main.SlavePV
AdvancedLoop.Main.TargetSetpoint	Target setpoint	float32	0301	769	Same as AdvancedLoop.Main.MasterPV
AdvancedLoop.MasterPID.ControlAction	Control action (0 = Reverse acting; 1 = Direct acting)	uint8	3103	12547	Not applicable
AdvancedLoop.MasterPID.CutbackHigh	Cutback high (0 = Auto)	float32	31af	12719	1dp
AdvancedLoop.MasterPID.CutbackLow	Cutback low (0 = Auto)	float32	31b0	12720	1dp
AdvancedLoop.MasterPID.DerivativeTime	Derivative time (0 = Off)	float32	31ae	12718	1dp
AdvancedLoop.MasterPID.DerivativeType	Derivative type (0 = PV; 1 = Error)	uint8	3105	12549	Not applicable
AdvancedLoop.MasterPID.ErrorLimit	Error limit	float32	31cc	12748	1dp
AdvancedLoop.MasterPID.IntegralTime	Integral time (0 = Off)	float32	31ad	12717	1dp
AdvancedLoop.MasterPID.LoopBreakTime	Loop break time (0 = Off)	float32	31b2	12722	0dp
AdvancedLoop.MasterPID.ManualReset	Manual reset	float32	31b1	12721	1dp
AdvancedLoop.MasterPID.PBUnits	Proportional band units (0 = Engineering; 1 = Percentage)	uint8	3104	12548	Not applicable
AdvancedLoop.MasterPID.ProportionalBand	Proportional band	float32	31ac	12716	1dp
AdvancedLoop.MasterSP.AltSP	Alternative setpoint	float32	3160	12640	Same as AdvancedLoop.Main.MasterPV
AdvancedLoop.MasterSP.AltSPSelect	Alternative setpoint enable (0 = No; 1 = Yes)	uint8	3161	12641	Not applicable
AdvancedLoop.MasterSP.ManualTrack	Manual track enable (0 = Off; 1 = On)	uint8	3167	12647	Not applicable
AdvancedLoop.MasterSP.RangeHigh	Range high	float32	3159	12633	Same as AdvancedLoop.Main.MasterPV
AdvancedLoop.MasterSP.RangeLow	Range low	float32	315a	12634	Same as AdvancedLoop.Main.MasterPV
AdvancedLoop.MasterSP.Rate	Setpoint rate limit value (0 = Off)	float32	3162	12642	Same as AdvancedLoop.Main.MasterPV
AdvancedLoop.MasterSP.RateDisable	Setpoint rate limit disable (0 = No; 1 = Yes)	bool	3163	12643	Not applicable

Parameter path	Description	Type	Hex	Dec	Resolution
AdvancedLoop.MasterSP.ServoToPV	Servo to PV enable (0 = No; 1 = Yes)	bool	316c	12652	Not applicable
AdvancedLoop.MasterSP.SP1	Setpoint 1	float32	315c	12636	Same as AdvancedLoop.Main.MasterPV
AdvancedLoop.MasterSP.SP2	Setpoint 2	float32	315d	12637	Same as AdvancedLoop.Main.MasterPV
AdvancedLoop.MasterSP.SPHighLimit	Setpoint high limit	float32	315e	12638	Same as AdvancedLoop.Main.MasterPV
AdvancedLoop.MasterSP.SPIntBal	SP integral balance (0 = Off; 1 = On)	bool	316b	12651	Not applicable
AdvancedLoop.MasterSP.SPLowLimit	Setpoint low limit	float32	315f	12639	Same as AdvancedLoop.Main.MasterPV
AdvancedLoop.MasterSP.SPSelect	Active setpoint select (0 - Setpoint 1; 1 = Setpoint 2)	uint8	315b	12635	Not applicable
AdvancedLoop.MasterSP.SPTrack	Setpoint tracking enable (0 = Off; 1 = On)	uint8	3168	12648	Not applicable
AdvancedLoop.MasterSP.SPTrim	Setpoint trim	float32	3164	12644	Same as AdvancedLoop.Main.MasterPV
AdvancedLoop.MasterSP.SPTrimHighLimit	Setpoint trim high limit	float32	3165	12645	Same as AdvancedLoop.Main.MasterPV
AdvancedLoop.MasterSP.SPTrimLowLimit	Setpoint trim low limit	float32	3166	12646	Same as AdvancedLoop.Main.MasterPV
AdvancedLoop.MasterSP.TrackPV	Track PV	float32	3169	12649	Same as AdvancedLoop.Main.MasterPV
AdvancedLoop.MasterSP.TrackSP	Track SP	float32	316a	12650	Same as AdvancedLoop.Main.MasterPV
AdvancedLoop.Output.Ch1OnOffHysteresis	Channel 1 on/off hysteresis	float32	3172	12658	Same as AdvancedLoop.Main.MasterPV
AdvancedLoop.Output.Ch1Output	Channel 1 output value	float32	030b	779	Same as AdvancedLoop.Output.OutputHighLimit
AdvancedLoop.Output.Ch1PotBreak	Channel 1 potentiometer break (0 = Off; 1 = On)	uint8	3179	12665	Not applicable
AdvancedLoop.Output.Ch1PotPosition	Channel 1 valve position	float32	3178	12664	0dp
AdvancedLoop.Output.Ch1TravelTime	Channel 1 travel time	float32	3174	12660	1dp
AdvancedLoop.Output.Ch2Deadband	Channel 2 deadband (0 = Off)	float32	316f	12655	Same as AdvancedLoop.Output.OutputHighLimit
AdvancedLoop.Output.Ch2OnOffHysteresis	Channel 2 on/off hysteresis	float32	3173	12659	Same as AdvancedLoop.Main.MasterPV
AdvancedLoop.Output.Ch2Output	Channel 2 (cool) output value	float32	030c	780	Same as AdvancedLoop.Output.OutputHighLimit
AdvancedLoop.Output.Ch2PotBreak	Channel 2 potentiometer break (0 = Off; 1 = On)	uint8	317b	12667	Not applicable
AdvancedLoop.Output.Ch2PotPosition	Channel 2 valve position	float32	317a	12666	0dp
AdvancedLoop.Output.Ch2TravelTime	Channel 2 travel time	float32	3175	12661	1dp
AdvancedLoop.Output.CoolType	Cooling algorithm type 0 = Linear 1 = Oil 2 = Water 3 = Fan	uint8	3183	12675	Not applicable
AdvancedLoop.Output.EnablePowerFeedforward	Power feed forward enable (0 = No; 1 = Yes)	uint8	3181	12673	Not applicable
AdvancedLoop.Output.FeedForwardGain	Feedforward gain	float32	3185	12677	3dp
AdvancedLoop.Output.FeedForwardOffset	Feedforward offset	float32	3186	12678	0dp
AdvancedLoop.Output.FeedForwardOutput	Feedforward output	float32	3188	12680	0dp
AdvancedLoop.Output.FeedForwardRemote	Feedforward remote	float32	318d	12685	0dp
AdvancedLoop.Output.FeedForwardTrimLimit	Feedforward trim limit	float32	3187	12679	0dp
AdvancedLoop.Output.FeedForwardType	Feedforward type 0 = None 1 = Remote 2 = SP 3 = PV	uint8	3184	12676	Not applicable
AdvancedLoop.Output.ForcedOP	Forced manual output value	float32	318f	12687	1dp
AdvancedLoop.Output.ManualMode	Manual output mode (0 = Track; 1 = Step; 2 = LastMOP)	uint8	317f	12671	Not applicable
AdvancedLoop.Output.ManualOutVal	Manual output value	float32	3180	12672	Same as AdvancedLoop.Output.OutputHighLimit
AdvancedLoop.Output.ManualStartup	Manual startup mode (0 = Off; 1 = On)	bool	3190	12688	Not applicable
AdvancedLoop.Output.MeasuredPower	Measured mains voltage	float32	3182	12674	0dp
AdvancedLoop.Output.NudgeLower	Valve nudge lower (0 = No; 1 = Yes)	uint8	3177	12663	Not applicable
AdvancedLoop.Output.NudgeRaise	Valve nudge raise (0 = No; 1 = Yes)	uint8	3176	12662	Not applicable
AdvancedLoop.Output.OutputHighLimit	Output high limit	float32	316d	12653	1dp
AdvancedLoop.Output.OutputLowLimit	Output low limit	float32	316e	12654	Same as AdvancedLoop.Output.OutputHighLimit
AdvancedLoop.Output.PotBreakMode	Potentiometer break mode 0 = Raise 1 = Lower 2 = Reset 3 = Model	uint8	317c	12668	Not applicable
AdvancedLoop.Output.Rate	Output rate limit value (0 = Off)	float32	3170	12656	1dp
AdvancedLoop.Output.RateDisable	Rate disable (0 = No; 1 = Yes)	bool	3171	12657	Not applicable
AdvancedLoop.Output.RemoteOutputHigh	Remote output high limit	float32	318c	12684	Same as AdvancedLoop.Main.ActiveOut
AdvancedLoop.Output.RemoteOutputLow	Remote output low limit	float32	318b	12683	Same as AdvancedLoop.Main.ActiveOut
AdvancedLoop.Output.SafeOutVal	Safe output value	float32	317e	12670	Same as AdvancedLoop.Output.OutputHighLimit
AdvancedLoop.Output.SbrkOP	Sensor break output	float32	318e	12686	Same as AdvancedLoop.Output.OutputHighLimit
AdvancedLoop.Output.SlaveSensorBreakMode	Slave sensor break mode (0 = SbrkOP; 1 = Hold)	uint8	317d	12669	Not applicable
AdvancedLoop.Output.TrackEnable	Enable output tracking (0 = Off; 1 = On)	uint8	318a	12682	Not applicable
AdvancedLoop.Output.TrackOutput	Output track value	float32	3189	12681	0dp
AdvancedLoop.Setup.CascadeType	Cascade type (0 = Full scale; 1 = Trim)	uint8	1606	5638	Not applicable
AdvancedLoop.Setup.MasterLoop	Master loop type (0 = PID)	uint8	31b3	12723	Not applicable
AdvancedLoop.Setup.MasterName	Master loop name	string_t	7010	28688	Not applicable

Parameter path	Description	Type	Hex	Dec	Resolution
AdvancedLoop.Setup.ModeAccess	Mode access 0 = R/W (Logged out) 1 = R/W (Operator) 2 = Read Only	uint8	31a8	12712	Not applicable
AdvancedLoop.Setup.SetpointAccess	Setpoint access (as Mode Access, above)	uint8	31a7	12711	Not applicable
AdvancedLoop.Setup.SlaveChannel1	Slave heat/channel 1 control type 0 = Off 1 = On/Off 2 = PID 3 = VPU 4 = VPB	uint8	3101	12545	Not applicable
AdvancedLoop.Setup.SlaveChannel2	Slave cool/channel 2 control type (as above)	uint8	3102	12546	Not applicable
AdvancedLoop.Setup.SlaveName	Slave loop name	string_t	7020	28704	Not applicable
AdvancedLoop.Setup.ManOutputAccess	Manual output access	uint8	31a9	12713	Not applicable
AdvancedLoop.SlavePID.ActiveSet	Active set (1 = Set 1; 2 = Set 2; 3 = Set 3)	uint8	3138	12600	Not applicable
AdvancedLoop.SlavePID.Boundary1-2	Scheduler boundary 1-2	float32	3139	12601	0dp
AdvancedLoop.SlavePID.Boundary2-3	Scheduler boundary 2-3	float32	133a	4922	0dp
AdvancedLoop.SlavePID.ControlAction	Control action (0 = Reverse acting; 1 = Direct acting)	uint8	3106	12550	Not applicable
AdvancedLoop.SlavePID.CutbackHigh	Cutback high set 1 (0 = Auto)	float32	313f	12607	1dp
AdvancedLoop.SlavePID.CutbackHigh2	Cutback high set 2 (0 = Auto)	float32	3147	12615	1dp
AdvancedLoop.SlavePID.CutbackHigh3	Cutback high set 3 (0 = Auto)	float32	314f	12623	1dp
AdvancedLoop.SlavePID.CutbackLow	Cutback low set 1 (0 = Auto)	float32	3140	12608	1dp
AdvancedLoop.SlavePID.CutbackLow2	Cutback low set 2 (0 = Auto)	float32	3148	12616	1dp
AdvancedLoop.SlavePID.CutbackLow3	Cutback low set 3 (0 = Auto)	float32	3150	12624	1dp
AdvancedLoop.SlavePID.DerivativeTime	Derivative time set 1 (0 = Off)	float32	313d	12605	1dp
AdvancedLoop.SlavePID.DerivativeTime2	Derivative time set 2 (0 = Off)	float32	3145	12613	1dp
AdvancedLoop.SlavePID.DerivativeTime3	Derivative time set 3 (0 = Off)	float32	314d	12621	1dp
AdvancedLoop.SlavePID.DerivativeType	Derivative type (0 = PV; 1 = Error)	uint8	3305	13061	Not applicable
AdvancedLoop.SlavePID.IntegralTime	Integral time set 1 (0 = Off)	float32	313c	12604	1dp
AdvancedLoop.SlavePID.IntegralTime2	Integral time set 2 (0 = Off)	float32	3144	12612	1dp
AdvancedLoop.SlavePID.IntegralTime3	Integral time set 3 (0 = Off)	float32	314c	12620	1dp
AdvancedLoop.SlavePID.LoopBreakTime	Loop break time set 1 (0 = Off)	float32	3142	12610	0dp
AdvancedLoop.SlavePID.LoopBreakTime2	Loop break time set 2 (0 = Off)	float32	314a	12618	0dp
AdvancedLoop.SlavePID.LoopBreakTime3	Loop break time set 3 (0 = Off)	float32	3152	12626	0dp
AdvancedLoop.SlavePID.ManualReset	Manual reset	float32	3141	12609	1dp
AdvancedLoop.SlavePID.ManualReset2	Manual reset 2	float32	3149	12617	1dp
AdvancedLoop.SlavePID.ManualReset3	Manual reset 3	float32	3151	12625	1dp
AdvancedLoop.SlavePID.NumberOfSets	Number of PID sets	uint8	3136	12598	Not applicable
AdvancedLoop.SlavePID.OutputHi2	Output high limit	float32	3155	12629	1dp
AdvancedLoop.SlavePID.OutputHi3	Output high limit	float32	3157	12631	1dp
AdvancedLoop.SlavePID.OutputHigh	Output high limit	float32	3153	12627	1dp
AdvancedLoop.SlavePID.OutputLo2	Output low limit 2	float32	3156	12630	1dp
AdvancedLoop.SlavePID.OutputLo3	Output low limit	float32	3158	12632	1dp
AdvancedLoop.SlavePID.OutputLow	Output low limit	float32	3154	12628	1dp
AdvancedLoop.SlavePID.PBUUnits	Proportional band units (0 = Engineering; 1 = Percentage)	uint8	3304	13060	Not applicable
AdvancedLoop.SlavePID.ProportionalBand	Proportional band set 1	float32	313b	12603	1dp
AdvancedLoop.SlavePID.ProportionalBand2	Proportional band set 2	float32	3143	12611	1dp
AdvancedLoop.SlavePID.ProportionalBand3	Proportional band set 3	float32	314b	12619	1dp
AdvancedLoop.SlavePID.RelCh2Gain	Relative cool/channel 2 gain	float32	313e	12606	1dp
AdvancedLoop.SlavePID.RelCh2Gain2	Relative cool/channel 2 gain 2	float32	3146	12614	1dp
AdvancedLoop.SlavePID.RelCh2Gain3	Relative cool/channel 2 gain 3	float32	314e	12622	1dp
AdvancedLoop.SlavePID.RemoteInput	Scheduler remote input	float32	3137	12599	0dp
AdvancedLoop.SlavePID.SchedulerType	Scheduler type 0 = Off 1 = Manually set 2 = Setpoint 3 = PV 4 = Error 5 = Output 6 = Remote	uint8	3135	12597	Not applicable
AdvancedLoop.SlaveSP.FFSelect	Feedforward select 0 = Master PV 1 = Master WSP 2 = Remote FF	uint8	31bf	12735	Not applicable
AdvancedLoop.SlaveSP.LocalSP	Local setpoint	float32	31b4	12724	Same as AdvancedLoop.Main.SlavePV
AdvancedLoop.SlaveSP.ManualTrack	Manual track enable (0 = Off; 1 = On)	uint8	31ca	12746	Not applicable
AdvancedLoop.SlaveSP.MasterSensorBreakMode	Master sensor break mode 0 = SbrkSP 1 = Hold 2 = SlaveSB	uint8	31c2	12738	Not applicable
AdvancedLoop.SlaveSP.RangeHigh	Range high	float32	31c0	12736	Same as AdvancedLoop.Main.SlavePV
AdvancedLoop.SlaveSP.RangeLow	Range low	float32	31c1	12737	Same as AdvancedLoop.Main.SlavePV
AdvancedLoop.SlaveSP.RemoteFeedForward	Remote feedforward input	float32	31bb	12731	Same as AdvancedLoop.Main.SlavePV
AdvancedLoop.SlaveSP.RemoteFFEnable	Remote feedforward enable (0 = No; 1 = Yes)	bool	31be	12734	Not applicable
AdvancedLoop.SlaveSP.RemoteFFHigh	Remote feedforward high	float32	31bc	12732	Same as AdvancedLoop.Main.SlavePV
AdvancedLoop.SlaveSP.RemoteFFLow	Remote feedforward low	float32	31bd	12733	Same as AdvancedLoop.Main.SlavePV

Parameter path	Description	Type	Hex	Dec	Resolution
AdvancedLoop.SlaveSP.SPHighLimit	Setpoint high limit	float32	31b5	12725	Same as AdvancedLoop.Main.SlavePV
AdvancedLoop.SlaveSP.SPLowLimit	Setpoint low limit	float32	31b6	12726	Same as AdvancedLoop.Main.SlavePV
AdvancedLoop.SlaveSP.TrimHighLimit	Trim high limit	float32	31b9	12729	Same as AdvancedLoop.Main.MasterPV
AdvancedLoop.SlaveSP.TrimLowLimit	Trim low limit	float32	31ba	12730	Same as AdvancedLoop.Main.MasterPV
AdvancedLoop.SlaveSP.TrimRangeHigh	Trim range high	float32	31b7	12727	Same as AdvancedLoop.Main.SlavePV
AdvancedLoop.SlaveSP.TrimRangeLow	Trim range low	float32	31b8	12728	Same as AdvancedLoop.Main.SlavePV
AdvancedLoop.Tune.A1	A1	float32	320d	12813	0dp
AdvancedLoop.Tune.A2	A2	float32	320e	12814	0dp
AdvancedLoop.Tune.Alpha	Alpha	float32	3211	12817	4dp
AdvancedLoop.Tune.Alpha_p	Alpha_p	float32	320f	12815	2dp
AdvancedLoop.Tune.ArgOP	Argument Output	float32	3209	12809	1dp
AdvancedLoop.Tune.ArgPV	Argument PV	float32	3208	12808	1dp
AdvancedLoop.Tune.Band	Band	float32	31c7	12743	1dp
AdvancedLoop.Tune.CycleNo	CycleNo	float32	3213	12819	0dp
AdvancedLoop.Tune.Debug	Debug	float32	3212	12818	2dp
AdvancedLoop.Tune.Diagnostics	Tuning diagnostics	bool	31cb	12747	Not applicable
AdvancedLoop.Tune.Gain	Gain	float32	320a	12810	1dp
AdvancedLoop.Tune.Hysteresis	Hysteresis	float32	31c6	12742	1dp
AdvancedLoop.Tune.MasterTune	Master tune	float32	3203	12803	0dp
AdvancedLoop.Tune.ModeMan	Mode Man	float32	3201	12801	0dp
AdvancedLoop.Tune.ModOP	Modulus OP	float32	3207	12807	1dp
AdvancedLoop.Tune.ModPV	Modulus PV	float32	3206	12806	1dp
AdvancedLoop.Tune.OP	Output	float32	3202	12802	1dp
AdvancedLoop.Tune.OPDel	OPDel	float32	0319	793	2dp
AdvancedLoop.Tune.OPss	OPss	float32	3210	12816	2dp
AdvancedLoop.Tune.OutputHighLimit	Output high	float32	3132	12594	Same as AdvancedLoop.Output.OutputHighLimit
AdvancedLoop.Tune.OutputLowLimit	Output low	float32	3133	12595	Same as AdvancedLoop.Output.OutputHighLimit
AdvancedLoop.Tune.PBs	PBs	float32	3214	12820	2dp
AdvancedLoop.Tune.Period	Period	float32	320c	12812	0dp
AdvancedLoop.Tune.Phase	Phase	float32	320b	12811	1dp
AdvancedLoop.Tune.Settle	Settle	float32	3216	12822	2dp
AdvancedLoop.Tune.Stage	Stage 0 = Reset 1 = None 2 = Settling 3 = Current SP 4 = New SP 5 = To SP 6 = Wait Max. 7 = Wait Min 8 = Store 9 = CoolT 10 = PID 11 = Abort 12 = Complete 13 = New R2g 14 = 1: Half Cycle 15 = 2: Full Cycle 16 = 3: Full Cycle 17 = 4: Final cycle 18 = 5: Calculating	uint8	0308	776	Not applicable
AdvancedLoop.Tune.StageTime	Stage time	float32	0309	777	0dp
AdvancedLoop.Tune.State	State 0 = Off 1 = Ready 2 - Running 3 = Complete 4 = Time-out 5 = Ti Limit 6 = R2G limit	uint8	0307	775	Not applicable
AdvancedLoop.Tune.TDs	TDs	float32	3215	12821	2dp
AdvancedLoop.Tune.Timeout	Timeout	float32	0326	806	0dp
AdvancedLoop.Tune.TuneEnable	Autotune enable (0 = Off; 1 = On)	bool	3131	12593	Not applicable
AdvancedLoop.Tune.TuneHigh	Tune high	float32	31c8	12744	Same as AdvancedLoop.Main.SlavePV
AdvancedLoop.Tune.TuneLow	Tune low	float32	31c9	12745	Same as AdvancedLoop.Main.SlavePV
AdvancedLoop.Tune.TuneR2G	Slave R2G tuning type 0 = Standard R2G tuning 1 = R2GPD tuning 2 = Off	uint8	3130	12592	Not applicable
AdvancedLoop.Tune.TuneSlave	Tune slave	float32	3204	12804	1dp
AdvancedLoop.Tune.TuneStatus	Tune Status 0 = Not tuning 1 = Tuning the slave 2 = Tuning the master 3 = Tuning complete -1 = Tuning aborted or timed-out	float32	3205	12805	0dp
AdvancedLoop.Tune.TuneType	Autotune algorithm type (0 = Slave; 1 = Master)	uint8	31c5	12741	Not applicable
AdvancedLoop.Tune.WSP	Working setpoint	float32	3200	12800	Same as AdvancedLoop.Main.MasterPV
AlarmSummary.AnyAlarm	0 = No active alarms; 1 = one or more alarms active	bool	01a2	418	Not applicable
AlarmSummary.AnyChanAlarm	0 = No channel alarms 1 = Channel alarm(s) active but all ack'd. 2 = Channel alarm(s) active but not all ack'd	uint8	01a0	416	Not applicable

Parameter path	Description	Type	Hex	Dec	Resolution
AlarmSummary.Channel.Alarm1Ack	Acknowledge the most recent channel alarm	bool	1192	4498	Not applicable
AlarmSummary.Channel.Alarm1Num	Channel and alarm number of most recent alarm 0 = No alarm 4 = Ch1;AI1 5 = Ch1;AI2 8 = Ch2;AI1 9 = Ch2AI2 12 = Ch3;AI1 13 = Ch3;AI2 16 = Ch4;AI1 17 = Ch4;AI2 132 = VC1;AI1 133 = VC1;AI2 136 = VC2;AI1 137 = VC2;AI2 140 = VC3;AI1 141 = VC3;AI2 144 = VC4;AI1 145 = VC4;AI2 148 = VC5;AI1 149 = VC5;AI2 152 = VC6;AI1 153 = VC6;AI2 156 = VC7;AI1 157 = VC7;AI2 160 = VC8;AI1 161 = VC8;AI2 164 = VC9;AI1 165 = VC9;AI2 168 = VC10;AI1 169 = VC10;AI2 172 = VC11;AI1 173 = VC11;AI2 176 = VC12;AI1 177 = VC12;AI2 180 = VC13;AI1 181 = VC13;AI2 184 = VC14;AI1 185 = VC14;AI2 188 = VC15;AI1 189 = VC15;AI2	uint8	1190	4496	Not applicable
AlarmSummary.Channel.Alarm1Status	Status of most recent alarm 0 = Off 1 = Active 2 = Safe unack 3 = Active unack	uint8	1191	4497	Not applicable
AlarmSummary.Channel.Alarm2Ack	Acknowledge the 2nd most recent channel alarm	bool	1195	4501	Not applicable
AlarmSummary.Channel.Alarm2Num	As Alarm1Num, but for 2nd most recent alarm	uint8	1193	4499	Not applicable
AlarmSummary.Channel.Alarm2Status	As Alarm1Status, but for 2nd most recent alarm	uint8	1194	4500	Not applicable
AlarmSummary.Channel.Alarm3Ack	Acknowledge the 3rd most recent channel alarm	bool	1198	4504	Not applicable
AlarmSummary.Channel.Alarm3Num	As Alarm1Num, but for 3rd most recent alarm	uint8	1196	4502	Not applicable
AlarmSummary.Channel.Alarm3Status	As Alarm1Status, but for 3rd most recent alarm	uint8	1197	4503	Not applicable
AlarmSummary.Channel.Alarm4Ack	Acknowledge the 4th most recent channel alarm	bool	119b	4507	Not applicable
AlarmSummary.Channel.Alarm4Num	As Alarm1Num, but for 4th most recent alarm	uint8	1199	4505	Not applicable
AlarmSummary.Channel.Alarm4Status	As Alarm1Status, but for 4th most recent alarm	uint8	119a	4506	Not applicable
AlarmSummary.Channel.Alarm5Ack	Acknowledge the 5th most recent channel alarm	bool	119e	4510	Not applicable
AlarmSummary.Channel.Alarm5Num	As Alarm1Num, but for 5th most recent alarm	uint8	119c	4508	Not applicable
AlarmSummary.Channel.Alarm5Status	As Alarm1Status, but for 5th most recent alarm	uint8	119d	4509	Not applicable
AlarmSummary.Channel.Alarm6Ack	Acknowledge the 6th most recent channel alarm	bool	11a1	4513	Not applicable
AlarmSummary.Channel.Alarm6Num	As Alarm1Num, but for 6th most recent alarm	uint8	119f	4511	Not applicable
AlarmSummary.Channel.Alarm6Status	As Alarm1Status, but for 6th most recent alarm	uint8	11a0	4512	Not applicable
AlarmSummary.Channel.Alarm7Ack	Acknowledge the 7th most recent channel alarm	bool	11a4	4516	Not applicable
AlarmSummary.Channel.Alarm7Num	As Alarm1Num, but for 7th most recent alarm	uint8	11a2	4514	Not applicable
AlarmSummary.Channel.Alarm7Status	As Alarm1Status, but for 7th most recent alarm	uint8	11a3	4515	Not applicable
AlarmSummary.Channel.Alarm8Ack	Acknowledge the 8th most recent channel alarm	bool	11a7	4519	Not applicable
AlarmSummary.Channel.Alarm8Num	As Alarm1Num, but for 8th most recent alarm	uint8	11a5	4517	Not applicable
AlarmSummary.Channel.Alarm8Status	As Alarm1Status, but for 8th most recent alarm	uint8	11a6	4518	Not applicable
AlarmSummary.Channel.Alarm9Ack	Acknowledge the 9th most recent channel alarm	bool	11aa	4522	Not applicable
AlarmSummary.Channel.Alarm9Num	As Alarm1Num, but for 9th most recent alarm	uint8	11a8	4520	Not applicable
AlarmSummary.Channel.Alarm9Status	As Alarm1Status, but for 9th most recent alarm	uint8	11a9	4521	Not applicable
AlarmSummary.Channel.Alarm10Ack	Acknowledge the 10th most recent channel alarm	bool	11ad	4525	Not applicable
AlarmSummary.Channel.Alarm10Num	As Alarm1Num, but for 10th most recent alarm	uint8	11ab	4523	Not applicable
AlarmSummary.Channel.Alarm10Status	As Alarm1Status, but for 10th most recent alarm	uint8	11ac	4524	Not applicable
AlarmSummary.Channel.Alarm11Ack	Acknowledge the 11th most recent channel alarm	bool	11b0	4528	Not applicable
AlarmSummary.Channel.Alarm11Num	As Alarm1Num, but for 11th most recent alarm	uint8	11ae	4526	Not applicable
AlarmSummary.Channel.Alarm11Status	As Alarm1Status, but for 11th most recent alarm	uint8	11af	4527	Not applicable
AlarmSummary.Channel.Alarm12Ack	Acknowledge the 12th most recent channel alarm	bool	11b3	4531	Not applicable
AlarmSummary.Channel.Alarm12Num	As Alarm1Num, but for 12th most recent alarm	uint8	11b1	4529	Not applicable
AlarmSummary.Channel.Alarm12Status	As Alarm1Status, but for 12th most recent alarm	uint8	11b2	4530	Not applicable
AlarmSummary.Channel.Alarm13Ack	Acknowledge the 13th most recent channel alarm	bool	11b6	4534	Not applicable
AlarmSummary.Channel.Alarm13Num	As Alarm1Num, but for 13th most recent alarm	uint8	11b4	4532	Not applicable
AlarmSummary.Channel.Alarm13Status	As Alarm1Status, but for 13th most recent alarm	uint8	11b5	4533	Not applicable
AlarmSummary.Channel.Alarm14Ack	Acknowledge the 14th most recent channel alarm	bool	11b9	4537	Not applicable
AlarmSummary.Channel.Alarm14Num	As Alarm1Num, but for 14th most recent alarm	uint8	11b7	4535	Not applicable
AlarmSummary.Channel.Alarm14Status	As Alarm1Status, but for 14th most recent alarm	uint8	11b8	4536	Not applicable
AlarmSummary.Channel.Alarm15Ack	Acknowledge the 15th most recent channel alarm	bool	11bc	4540	Not applicable
AlarmSummary.Channel.Alarm15Num	As Alarm1Num, but for 15th most recent alarm	uint8	11ba	4538	Not applicable
AlarmSummary.Channel.Alarm15Status	As Alarm1Status, but for 15th most recent alarm	uint8	11bb	4539	Not applicable
AlarmSummary.Channel.Alarm16Ack	Acknowledge the 16th most recent channel alarm	bool	11bf	4543	Not applicable
AlarmSummary.Channel.Alarm16Num	As Alarm1Num, but for 16th most recent alarm	uint8	11bd	4541	Not applicable
AlarmSummary.Channel.Alarm16Status	As Alarm1Status, but for 16th most recent alarm	uint8	11be	4542	Not applicable
AlarmSummary.Channel.Alarm17Ack	Acknowledge the 17th most recent channel alarm	bool	11c2	4546	Not applicable
AlarmSummary.Channel.Alarm17Num	As Alarm1Num, but for 17th most recent alarm	uint8	11c0	4544	Not applicable
AlarmSummary.Channel.Alarm17Status	As Alarm1Status, but for 17th most recent alarm	uint8	11c1	4545	Not applicable
AlarmSummary.Channel.Alarm18Ack	Acknowledge the 18th most recent channel alarm	bool	11c5	4549	Not applicable
AlarmSummary.Channel.Alarm18Num	As Alarm1Num, but for 18th most recent alarm	uint8	11c3	4547	Not applicable

Parameter path	Description	Type	Hex	Dec	Resolution
AlarmSummary.Channel.Alarm19Ack	Acknowledge the 19th most recent channel alarm	bool	11c8	4552	Not applicable
AlarmSummary.Channel.Alarm19Num	As Alarm1Num, but for 19th most recent alarm	uint8	11c6	4550	Not applicable
AlarmSummary.Channel.Alarm19Status	As Alarm1Status, but for 19th most recent alarm	uint8	11c7	4551	Not applicable
AlarmSummary.Channel.Alarm20Ack	Acknowledge the 20th most recent channel alarm	bool	11cb	4555	Not applicable
AlarmSummary.Channel.Alarm20Num	As Alarm1Num, but for 20th most recent alarm	uint8	11c9	4553	Not applicable
AlarmSummary.Channel.Alarm20Status	As Alarm1Status, but for 20th most recent alarm	uint8	11ca	4554	Not applicable
AlarmSummary.Channel.Alarm21Ack	Acknowledge the 21st most recent channel alarm	bool	11ce	4558	Not applicable
AlarmSummary.Channel.Alarm21Num	As Alarm1Num, but for 21st most recent alarm	uint8	11cc	4556	Not applicable
AlarmSummary.Channel.Alarm21Status	As Alarm1Status, but for 21st most recent alarm	uint8	11cd	4557	Not applicable
AlarmSummary.Channel.Alarm22Ack	Acknowledge the 22nd most recent channel alarm	bool	11d1	4561	Not applicable
AlarmSummary.Channel.Alarm22Num	As Alarm1Num, but for 22nd most recent alarm	uint8	11cf	4559	Not applicable
AlarmSummary.Channel.Alarm22Status	As Alarm1Status, but for 22nd most recent alarm	uint8	11d0	4560	Not applicable
AlarmSummary.Channel.Alarm23Ack	Acknowledge the 23rd most recent channel alarm	bool	11d4	4564	Not applicable
AlarmSummary.Channel.Alarm23Num	As Alarm1Num, but for 23th most recent alarm	uint8	11d2	4562	Not applicable
AlarmSummary.Channel.Alarm23Status	As Alarm1Status, but for 23rd most recent alarm	uint8	11d3	4563	Not applicable
AlarmSummary.Channel.Alarm24Ack	Acknowledge the 24th most recent channel alarm	bool	11d7	4567	Not applicable
AlarmSummary.Channel.Alarm24Num	As Alarm1Num, but for 24th most recent alarm	uint8	11d5	4565	Not applicable
AlarmSummary.Channel.Alarm24Status	As Alarm1Status, but for 24th most recent alarm	uint8	11d6	4566	Not applicable
AlarmSummary.Channel.Alarm25Ack	Acknowledge the 25th most recent channel alarm	bool	11da	4570	Not applicable
AlarmSummary.Channel.Alarm25Num	As Alarm1Num, but for 25th most recent alarm	uint8	11d8	4568	Not applicable
AlarmSummary.Channel.Alarm25Status	As Alarm1Status, but for 25th most recent alarm	uint8	11d9	4569	Not applicable
AlarmSummary.Channel.Alarm26Ack	Acknowledge the 26th most recent channel alarm	bool	11dd	4573	Not applicable
AlarmSummary.Channel.Alarm26Num	As Alarm1Num, but for 26th most recent alarm	uint8	11db	4571	Not applicable
AlarmSummary.Channel.Alarm26Status	As Alarm1Status, but for 26th most recent alarm	uint8	11dc	4572	Not applicable
AlarmSummary.Channel.Alarm27Ack	Acknowledge the 27th most recent channel alarm	bool	11e0	4576	Not applicable
AlarmSummary.Channel.Alarm27Num	As Alarm1Num, but for 27th most recent alarm	uint8	11de	4574	Not applicable
AlarmSummary.Channel.Alarm27Status	As Alarm1Status, but for 27th most recent alarm	uint8	11df	4575	Not applicable
AlarmSummary.Channel.Alarm28Ack	Acknowledge the 28th most recent channel alarm	bool	11e3	4579	Not applicable
AlarmSummary.Channel.Alarm28Num	As Alarm1Num, but for 28th most recent alarm	uint8	11e1	4577	Not applicable
AlarmSummary.Channel.Alarm28Status	As Alarm1Status, but for 28th most recent alarm	uint8	11e2	4578	Not applicable
AlarmSummary.Channel.Alarm29Ack	Acknowledge the 29th most recent channel alarm	bool	11e6	4582	Not applicable
AlarmSummary.Channel.Alarm29Num	As Alarm1Num, but for 29th most recent alarm	uint8	11e4	4580	Not applicable
AlarmSummary.Channel.Alarm29Status	As Alarm1Status, but for 29th most recent alarm	uint8	11e5	4581	Not applicable
AlarmSummary.Channel.Alarm30Ack	Acknowledge the 30th most recent channel alarm	bool	11e9	4585	Not applicable
AlarmSummary.Channel.Alarm30Num	As Alarm1Num, but for 30th most recent alarm	uint8	11e7	4583	Not applicable
AlarmSummary.Channel.Alarm30Status	As Alarm1Status, but for 30th most recent alarm	uint8	11e8	4584	Not applicable
AlarmSummary.Channel.Alarm31Ack	Acknowledge the 31st most recent channel alarm	bool	11ec	4588	Not applicable
AlarmSummary.Channel.Alarm31Num	As Alarm1Num, but for 31st most recent alarm	uint8	11ea	4586	Not applicable
AlarmSummary.Channel.Alarm31Status	As Alarm1Status, but for 31st most recent alarm	uint8	11eb	4587	Not applicable
AlarmSummary.Channel.Alarm32Ack	Acknowledge the 32nd most recent channel alarm	bool	11ef	4591	Not applicable
AlarmSummary.Channel.Alarm32Num	As Alarm1Num, but for 32nd most recent alarm	uint8	11ed	4589	Not applicable
AlarmSummary.Channel.Alarm32Status	As Alarm1Status, but for 32nd most recent alarm	uint8	11ee	4590	Not applicable
AlarmSummary.Channel.Alarm33Ack	Acknowledge the 33rd most recent channel alarm	bool	11f2	4594	Not applicable
AlarmSummary.Channel.Alarm33Num	As Alarm1Num, but for 33rd most recent alarm	uint8	11f0	4592	Not applicable
AlarmSummary.Channel.Alarm33Status	As Alarm1Status, but for 33rd most recent alarm	uint8	11f1	4593	Not applicable
AlarmSummary.Channel.Alarm34Ack	Acknowledge the 34th most recent channel alarm	bool	11f5	4597	Not applicable
AlarmSummary.Channel.Alarm34Num	As Alarm1Num, but for 34th most recent alarm	uint8	11f3	4595	Not applicable
AlarmSummary.Channel.Alarm34Status	As Alarm1Status, but for 34th most recent alarm	uint8	11f4	4596	Not applicable
AlarmSummary.Channel.Alarm35Ack	Acknowledge the 35th most recent channel alarm	bool	11f8	4600	Not applicable
AlarmSummary.Channel.Alarm35Num	As Alarm1Num, but for 35th most recent alarm	uint8	11f6	4598	Not applicable
AlarmSummary.Channel.Alarm35Status	As Alarm1Status, but for 35th most recent alarm	uint8	11f7	4599	Not applicable
AlarmSummary.Channel.Alarm36Ack	Acknowledge the 36th most recent channel alarm	bool	11fb	4603	Not applicable
AlarmSummary.Channel.Alarm36Num	As Alarm1Num, but for 36th most recent alarm	uint8	11f9	4601	Not applicable
AlarmSummary.Channel.Alarm36Status	As Alarm1Status, but for 36th most recent alarm	uint8	11fa	4602	Not applicable
AlarmSummary.Channel.Alarm37Ack	Acknowledge the 37th most recent channel alarm	bool	11fe	4606	Not applicable
AlarmSummary.Channel.Alarm37Num	As Alarm1Num, but for 37th most recent alarm	uint8	11fc	4604	Not applicable
AlarmSummary.Channel.Alarm37Status	As Alarm1Status, but for 38th most recent alarm	uint8	11fd	4605	Not applicable
AlarmSummary.Channel.Alarm38Ack	Acknowledge the 38th most recent channel alarm	bool	1201	4609	Not applicable
AlarmSummary.Channel.Alarm38Num	As Alarm1Num, but for 38th most recent alarm	uint8	11ff	4607	Not applicable
AlarmSummary.Channel.Alarm38Status	As Alarm1Status, but for 38th most recent alarm	uint8	1200	4608	Not applicable
AlarmSummary.ChannelAck	Acknowledge all alarms. 0x11c0 - 0x1200	bool	01c0	440	Not applicable

Parameter path	Description	Type	Hex	Dec	Resolution
	Bit 0: 1 = Channel 1 Alarm 1 active				
	Bit 1: 1 = Channel 1 Alarm 1 not acknowledged				
	Bit 2: 1 = Channel 1 Alarm 2 active				
	Bit 3: 1 = Channel 1 Alarm 2 not acknowledged				
	Bit 4: 1 = Channel 2 Alarm 1 active				
	Bit 5: 1 = Channel 2 Alarm 1 not acknowledged				
	Bit 6: 1 = Channel 2 Alarm 2 active				
	Bit 7: 1 = Channel 2 Alarm 2 not acknowledged				
	Bit 8: 1 = Channel 3 Alarm 1 active				
	Bit 9: 1 = Channel 3 Alarm 1 not acknowledged				
	Bit 10: 1 = Channel 3 Alarm 2 active				
	Bit 11: 1 = Channel 3 Alarm 2 not acknowledged				
	Bit 12: 1 = Channel 4 Alarm 1 active				
	Bit 13: 1 = Channel 4 Alarm 1 not acknowledged				
	Bit 14: 1 = Channel 4 Alarm 2 active				
	Bit 15: 1 = Channel 4 Alarm 2 not acknowledged				
AlarmSummary.StatusWord2	A summary of Virtual Channel 1 to 4 alarms	int16	01a5	421	Not applicable
	Bit 0: 1 = Virtual channel 1 Alarm 1 active				
	Bit 1: 1 = Virtual channel 1 Alarm 1 not ack'd				
	Bit 2: 1 = Virtual channel 1 Alarm 2 active				
	Bit 3: 1 = Virtual channel 1 Alarm 2 not ack'd				
	Bit 4: 1 = Virtual channel 2 Alarm 1 active				
	Bit 5: 1 = Virtual channel 2 Alarm 1 not ack'd				
	Bit 6: 1 = Virtual channel 2 Alarm 2 active				
	Bit 7: 1 = Virtual channel 2 Alarm 2 not ack'd				
	Bit 8: 1 = Virtual channel 3 Alarm 1 active				
	Bit 9: 1 = Virtual channel 3 Alarm 1 not ack'd				
	Bit 10: 1 = Virtual channel 3 Alarm 2 active				
	Bit 11: 1 = Virtual channel 3 Alarm 2 not ack'd				
	Bit 12: 1 = Virtual channel 4 Alarm 1 active				
	Bit 13: 1 = Virtual channel 4 Alarm 1 not ack'd				
	Bit 14: 1 = Virtual channel 4 Alarm 2 active				
	Bit 15: 1 = Virtual channel 4 Alarm 2 not ack'd				
AlarmSummary.StatusWord3	A summary of Virtual Channel 5 to 8 alarms	int16	01a6	422	Not applicable
	As for Status Word 2 but for virtual channels 5 to 8				
AlarmSummary.StatusWord4	A summary of Virtual Channel 9 to 12 alarms	int16	01a7	423	Not applicable
	As for Status Word 2 but for virtual channels 9 to 12				
AlarmSummary.StatusWord5	A summary of Virtual Channel 13 to 14 alarms	int16	01a8	424	Not applicable
	As for Status Word 2 but for virtual channels 13 to 14				
AlarmSummary.System.Alarm1ID	Most recent active system alarm	uint8	1210	4624	Not applicable
	0 = No Alarm 1 = Low battery				
	2 = Battery failure 3 = System clock fail				
	4 = Channel error 5 = Channel fail				
	6 = DHCP server fail 7 = FTP Archive file lost				
	8 = FTP Archive slow 9 = FTP Primary server failure				
	10 = FTP Secondary server failure				
	11 = Insufficient non-volatile memory				
	12 = Maths channel failure 13 = Media archive file lost				
	14 = Media archive slow 15 = Network boot failure				
	16 = DC Output Cal. Error 17 = Recording failure				
	18 = Media failure 19 = Media full				
	20 =SNTP failure 21 = Time synchronisation failure				
	22 = Media missing 23: Archive disabled				
	24 = Archiving failed 25 = Archiving timed out				
	26 = USB Over Current 27 = USB unsupported				
	28 = Invalid parameter database				
	29 = Invalid non-volatile data				
	30 = Flash write failure 31 = Wiring failure				
	32 = Broadcast Storm				
	33 = Non-volatile memory write frequency warning				
AlarmSummary.System.Alarm2ID	2nd most recent active system alarm (as Alarm1ID)	uint8	1211	4625	Not applicable
AlarmSummary.System.Alarm3ID	3rd most recent active system alarm (as Alarm1ID)	uint8	1212	4626	Not applicable
AlarmSummary.System.Alarm4ID	4th most recent active system alarm (as Alarm1ID)	uint8	1213	4627	Not applicable
AlarmSummary.System.Alarm5ID	5th most recent active system alarm (as Alarm1ID)	uint8	1214	4628	Not applicable
AlarmSummary.System.Alarm6ID	6th most recent active system alarm (as Alarm1ID)	uint8	1215	4629	Not applicable
AlarmSummary.System.Alarm7ID	7th most recent active system alarm (as Alarm1ID)	uint8	1216	4630	Not applicable
AlarmSummary.System.Alarm8ID	8th most recent active system alarm (as Alarm1ID)	uint8	1217	4631	Not applicable
AlarmSummary.System.Alarm9ID	9th most recent active system alarm (as Alarm1ID)	uint8	1218	4632	Not applicable
AlarmSummary.System.Alarm10ID	10th most recent active system alarm (as Alarm1ID)	uint8	1219	4633	Not applicable
AlarmSummary.System.Alarm11ID	11th most recent active system alarm (as Alarm1ID)	uint8	121a	4634	Not applicable

Parameter path	Description	Type	Hex	Dec	Resolution
AlarmSummary.System.Alarm13ID	13th most recent active system alarm (as Alarm1ID)	uint8	121c	4636	Not applicable
AlarmSummary.System.Alarm14ID	14th most recent active system alarm (as Alarm1ID)	uint8	121d	4637	Not applicable
AlarmSummary.System.Alarm15ID	15th most recent active system alarm (as Alarm1ID)	uint8	121e	4638	Not applicable
AlarmSummary.System.Alarm16ID	16th most recent active system alarm (as Alarm1ID)	uint8	121f	4639	Not applicable
AlarmSummary.System.Alarm17ID	17th most recent active system alarm (as Alarm1ID)	uint8	1220	4640	Not applicable
AlarmSummary.System.Alarm18ID	18th most recent active system alarm (as Alarm1ID)	uint8	1221	4641	Not applicable
AlarmSummary.System.Alarm19ID	19th most recent active system alarm (as Alarm1ID)	uint8	1222	4642	Not applicable
AlarmSummary.System.Alarm20ID	20th most recent active system alarm (as Alarm1ID)	uint8	1223	4643	Not applicable
AlarmSummary.System.Alarm21ID	21st most recent active system alarm (as Alarm1ID)	uint8	1224	4644	Not applicable
AlarmSummary.System.Alarm22ID	22nd most recent active system alarm (as Alarm1ID)	uint8	1225	4645	Not applicable
AlarmSummary.System.Alarm23ID	23rd most recent active system alarm (as Alarm1ID)	uint8	1226	4646	Not applicable
AlarmSummary.System.Alarm24ID	24th most recent active system alarm (as Alarm1ID)	uint8	1227	4647	Not applicable
AlarmSummary.System.Alarm25ID	25th most recent active system alarm (as Alarm1ID)	uint8	1228	4648	Not applicable
AlarmSummary.System.Alarm26ID	26th most recent active system alarm (as Alarm1ID)	uint8	1229	4649	Not applicable
AlarmSummary.System.Alarm27ID	27th most recent active system alarm (as Alarm1ID)	uint8	122a	4650	Not applicable
AlarmSummary.System.Alarm28ID	28th most recent active system alarm (as Alarm1ID)	uint8	122b	4651	Not applicable
AlarmSummary.System.Alarm29ID	29th most recent active system alarm (as Alarm1ID)	uint8	122c	4652	Not applicable
AlarmSummary.System.Alarm30ID	30th most recent active system alarm (as Alarm1ID)	uint8	122d	4653	Not applicable
AlarmSummary.System.Alarm31ID	31st most recent active system alarm (as Alarm1ID)	uint8	122e	4654	Not applicable
AlarmSummary.System.Alarm32ID	32nd most recent active system alarm (as Alarm1ID)	uint8	122f	4655	Not applicable
Batch.OnStartLog	The number of fields to log in history file on start	uint8	3053	12371	Not applicable
Batch.BatchFields	The number of batch fields the user must populate	uint8	305a	12378	Not applicable
Batch.Start	Trigger to start a batch	bool	3058	12376	Not applicable
Batch.Stop	Aborts the current batch	bool	3059	12377	Not applicable
Batch.Active	The current batch status	uint8	3050	12368	Not applicable
Batch.Mode	The selectable batch mode	uint8	3051	12369	Not applicable
Batch.OnNewClear	The number of fields to clear on a new batch start	uint8	3055	12373	Not applicable
Batch.OnStopLog	The number of fields to log in the history file on stop	uint8	3054	12372	Not applicable
Batch.1FieldDescriptor1	Field descriptor (heading) for batch field 1	string_t	7801	30721	Not applicable
Batch.1FieldDescriptor2	Field descriptor (heading) for batch field 2	string_t	7802	30722	Not applicable
Batch.1FieldDescriptor3	Field descriptor (heading) for batch field 3	string_t	7803	30723	Not applicable
Batch.1FieldDescriptor4	Field descriptor (heading) for batch field 4	string_t	7804	30724	Not applicable
Batch.1FieldDescriptor5	Field descriptor (heading) for batch field 5	string_t	7805	30725	Not applicable
Batch.1FieldDescriptor6	Field descriptor (heading) for batch field 6	string_t	7806	30726	Not applicable
Batch1.FieldData1	Field data (content) for batch field 1	string_t	7807	30727	Not applicable
Batch1.FieldData2	Field data (content) for batch field 2	string_t	7808	30728	Not applicable
Batch1.FieldData3	Field data (content) for batch field 3	string_t	7809	30729	Not applicable
Batch1.FieldData4	Field data (content) for batch field 4	string_t	780a	30730	Not applicable
Batch1.FieldData5	Field data (content) for batch field 5	string_t	780b	30731	Not applicable
Batch1.FieldData6	Field data (content) for batch field 6	string_t	780c	30732	Not applicable
Batch.PrintVersion	If to print version numbers	bool	3056	12374	Not applicable
Batch.Duration	The duration of the current batch	time_t	0401	1025	Set by Network.Modbus.TimeFormat
Batch.NameFileByBatch	Generates a batch in a new history file by name	bool	3057	12375	Not applicable
Batch.PVStart	PV Start	float32	0402	1026	0dp
Batch.BatchField1	Batch field 1 mode	uint8	3052	12370	Not applicable
Batch.StartTime	Batch start time	time_t	0400	1024	Set by Network.Modbus.TimeFormat
Batch.StartDate	Batch start date	string_t	77d5	30677	Not applicable
Batch.New	New batch	bool	305c	12380	Not applicable
BCDInput.1.BCDVal	BCD1 BCD Value	uint8	2ed1	11985	Not applicable
BCDInput.1.DecByte	BCD1 Decimal Value	uint8	2ed0	11984	Not applicable
BCDInput.1.In1	BCD1 Input 1 (0 = Off; 1 = On)	bool	2ec8	11976	Not applicable
BCDInput.1.In2	BCD1 Input 2 (0 = Off; 1 = On)	bool	2ec9	11977	Not applicable
BCDInput.1.In3	BCD1 Input 3 (0 = Off; 1 = On)	bool	2eca	11978	Not applicable
BCDInput.1.In4	BCD1 Input 4 (0 = Off; 1 = On)	bool	2ecb	11979	Not applicable
BCDInput.1.In5	BCD1 Input 5 (0 = Off; 1 = On)	bool	2ecc	11980	Not applicable
BCDInput.1.In6	BCD1 Input 6 (0 = Off; 1 = On)	bool	2ecd	11981	Not applicable
BCDInput.1.In7	BCD1 Input 7 (0 = Off; 1 = On)	bool	2ece	11982	Not applicable
BCDInput.1.In8	BCD1 Input 8 (0 = Off; 1 = On)	bool	2ecf	11983	Not applicable
BCDInput.1.Temp	BCD1 Temp (MSD)	uint8	2ed2	11986	Not applicable

Parameter path	Description	Type	Hex	Dec	Resolution
BCDInput.1.SettleTime	Settle Time	float32	3042	12354	1dp
BCDInput.2.BCDVal	BCD2 BCD Value	uint8	2edd	11997	Not applicable
BCDInput.2.DecByte	BCD2 Decimal Value	uint8	2edc	11996	Not applicable
BCDInput.2.In1	BCD2 Input 1 (0 = Off; 1 = On)	bool	2ed4	11988	Not applicable
BCDInput.2.In2	BCD2 Input 2 (0 = Off; 1 = On)	bool	2ed5	11989	Not applicable
BCDInput.2.In3	BCD2 Input 3 (0 = Off; 1 = On)	bool	2ed6	11990	Not applicable
BCDInput.2.In4	BCD2 Input 4 (0 = Off; 1 = On)	bool	2ed7	11991	Not applicable
BCDInput.2.In5	BCD2 Input 5 (0 = Off; 1 = On)	bool	2ed8	11992	Not applicable
BCDInput.2.In6	BCD2 Input 6 (0 = Off; 1 = On)	bool	2ed9	11993	Not applicable
BCDInput.2.In7	BCD2 Input 7 (0 = Off; 1 = On)	bool	2eda	11994	Not applicable
BCDInput.2.In8	BCD2 Input 8 (0 = Off; 1 = On)	bool	2edb	11995	Not applicable
BCDInput.2.Tens	BCD2 Tens (MSD)	uint8	2edf	11999	Not applicable
BCDInput.2.Units	BCD2 Units (LSD)	uint8	2ede	11998	Not applicable
BCDInput.2.SettleTime	Settle Time	float32	3043	12355	1dp
Channel.1.Alarm1.Acknowledge	1 = Acknowledge alarm	bool	01b0	432	Not applicable
Channel.1.Alarm1.Acknowledgement	1 = Alarm acknowledged	bool	1850	6224	Not applicable
Channel.1.Alarm1.Active	1 = Alarm source active, or safe but not ack'd	bool	184b	6219	Not applicable
Channel.1.Alarm1.Amount	Alarm amount	float32	1848	6216	Same as Channel.1.Main.PV
Channel.1.Alarm1.AverageTime	Average time	time_t	184a	6218	Set by Network.Modbus.TimeFormat
Channel.1.Alarm1.Block	Blocking enable (0 = Off; 1 = On)	uint8	1842	6210	Not applicable
Channel.1.Alarm1.ChangeTime	Change time (0 = Per second; 1 = Per minute; 2 =Per hour)	uint8	1849	6217	Not applicable
Channel.1.Alarm1.Deviation	Alarm deviation	float32	1847	6215	Same as Channel.1.Main.PV
Channel.1.Alarm1.Dwell	Alarm dwell	time_t	1845	6213	Set by Network.Modbus.TimeFormat
Channel.1.Alarm1.Hysteresis	Alarm hysteresis	float32	1844	6212	Same as Channel.1.Main.PV
Channel.1.Alarm1.Inactive	1 = the alarm is safe and acknowledged	bool	184e	6222	Not applicable
Channel.1.Alarm1.Inhibit	1 = the alarm is inhibited	bool	1851	6225	Not applicable
Channel.1.Alarm1.Latch	Alarm latch type 0 = None 1 = Auto 2 = Manual 3 = Trigger	uint8	1841	6209	Not applicable
Channel.1.Alarm1.NotAcknowledged	1 = the alarm has not been acknowledged	bool	184f	6223	Not applicable
Channel.1.Alarm1.Reference	Alarm reference	float32	1846	6214	Same as Channel.1.Main.PV
Channel.1.Alarm1.Status	Alarm status 0 = Off 1 = Active 2 = Safe not acknowledged 3 = Active not acknowledged	uint8	0102	258	Not applicable
Channel.1.Alarm1.Threshold	Alarm threshold	float32	1843	6211	Same as Channel.1.Main.PV
Channel.1.Alarm1.Type	Alarm type 0 = None 1 = Abs High 2 = Abs Low 3 = Dev high 4 = Dev Low 5 = Dev band 6 = ROC rising 7 = ROC falling 10 = Dig Off 11 = Dig high 12 = Dig Low	uint8	1840	6208	Not applicable
Channel.1.Alarm2.Acknowledge	1 = Acknowledge alarm	bool	01b1	433	Not applicable
Channel.1.Alarm2.Acknowledgement	1 = Alarm acknowledged	bool	1870	6256	Not applicable
Channel.1.Alarm2.Active	1 = Alarm source active, or safe but not ack'd	bool	186b	6251	Not applicable
Channel.1.Alarm2.Amount	Alarm amount	float32	1868	6248	Same as Channel.1.Main.PV
Channel.1.Alarm2.AverageTime	Average time	time_t	186a	6250	Set by Network.Modbus.TimeFormat
Channel.1.Alarm2.Block	Blocking enable (0 = Off; 1 = On)	uint8	1862	6242	Not applicable
Channel.1.Alarm2.ChangeTime	Change time (0 = Per second; 1 = Per minute; 2 =Per hour)	uint8	1869	6249	Not applicable
Channel.1.Alarm2.Deviation	Alarm deviation	float32	1867	6247	Same as Channel.1.Main.PV
Channel.1.Alarm2.Dwell	Alarm dwell	time_t	1865	6245	Set by Network.Modbus.TimeFormat
Channel.1.Alarm2.Hysteresis	Alarm hysteresis	float32	1864	6244	Same as Channel.1.Main.PV
Channel.1.Alarm2.Inactive	1 = the alarm is safe and acknowledged	bool	186e	6254	Not applicable
Channel.1.Alarm2.Inhibit	1 = the alarm is inhibited	bool	1871	6257	Not applicable
Channel.1.Alarm2.Latch	Configures the latching type of the alarm (As Alarm1.Latch)	uint8	1861	6241	Not applicable
Channel.1.Alarm2.NotAcknowledged	1 = the alarm has not been acknowledged	bool	186f	6255	Not applicable
Channel.1.Alarm2.Reference	Alarm reference	float32	1866	6246	Same as Channel.1.Main.PV
Channel.1.Alarm2.Status	As Alarm1.Status	uint8	0103	259	Not applicable
Channel.1.Alarm2.Threshold	Alarm threshold	float32	1863	6243	Same as Channel.1.Main.PV
Channel.1.Alarm2.Type	Alarm type (as Alarm1.Type)	uint8	1860	6240	Not applicable
Channel.1.Main.CJType	Cold junction compensation type 0 = None 1 = Internal 2 = External 3 = Remote (Ch1) 4 = Remote (Ch2) 5 = Remote (Ch3) 6 = Remote (Ch4)	uint8	180c	6156	Not applicable

Parameter path	Description	Type	Hex	Dec	Resolution
Channel.1.Main.Descriptor	Text string to describe the channel	string_t	4900	18688	Not applicable
Channel.1.Main.ExtCJTemp	External CJ temperature	float32	180d	6157	1dp
Channel.1.Main.FaultResponse	Fault response. 0 = none; 1 = Drive high; 2 = Drive low	uint8	1810	6160	Not applicable
Channel.1.Main.Filter	Filter time constant	float32	180e	6158	1dp
Channel.1.Main.InputHigh	Input range high value	float32	1804	6148	1dp
Channel.1.Main.InputLow	Input range low value	float32	1803	6147	1dp
Channel.1.Main.InternalCJTemp	Channel internal cold junction temperature	float32	1815	6165	1dp
Channel.1.Main.IPAdjustState	Input Adjust state (0 = Unadjusted; 1 = Adjusted)	bool	1816	6166	Not applicable
Channel.1.Main.IPAdjustState2	Secondary Input Adjust state (0 = Unadjusted; 1 = Adjusted)	bool	181c	6172	Not applicable
Channel.1.Main.LinType	Linearisation type 0 = Type B 1 = Type C 2 = Type D 3 = Type E 4 = Type G2 5 = Type J 6 = Type K 7 = Type L 8 = Type N 9 = Type R 10 = Type S 11 = Type T 12 = Type U 13 = NiMoNiCo 14 = Platinel 15 = NiNiMo 16 = Pt20RhPt40Rh 17 = User 1 18 = User 2 19 = User 3 20 = User 4 21 = Cu10 22 = Pt100 23 = Pt100A 24 = JPT100 25 = Ni100 26 = Ni120 27 = Cu53 28 = Linear 29 = Sqrt 30 = x ^{3/2} 32 = x ^{5/2}	uint8	1806	6150	Not applicable
Channel.1.Main.MeasuredValue	Input value before linearisation, scaling, adjust etc.	float32	1814	6164	Set by Channel.1.Main.Resolution
Channel.1.Main.MeasuredValue2	Measured value of the secondary input	float32	1819	6169	Set by Channel.1.Main.Resolution
Channel.1.Main.Offset	Fixed value to be added to/subtracted from PV	float32	1817	6167	3dp
Channel.1.Main.Offset2	Secondary input offset (as above).	float32	1818	6168	3dp
Channel.1.Main.OpenString	Open String	string_t	496c	18796	Not applicable
Channel.1.Main.PV	The process variable (output) of the channel	float32	0100	256	Set by Channel.1.Main.Resolution
Channel.1.Main.PV2	The secondary input process variable (output) of the channel	float32	0110	272	Set by Channel.1.Main.Resolution
Channel.1.Main.RangeHigh	Range high value	float32	1808	6152	Set by Channel.1.Main.Resolution
Channel.1.Main.RangeLow	Range low value	float32	1807	6151	Set by Channel.1.Main.Resolution
Channel.1.Main.RangeUnits	Range units: 0 = °C; 1 = °F; 2 = Kelvins	uint8	1809	6153	Not applicable
Channel.1.Main.Resolution	Specifies the resolution/number of decimal places	uint8	1801	6145	Not applicable
Channel.1.Main.ScaleHigh	Scale high value	float32	180b	6155	Set by Channel.1.Main.Resolution
Channel.1.Main.ScaleHigh2	Scale high value for the secondary input	float32	181b	6171	Set by Channel.1.Main.Resolution
Channel.1.Main.ScaleLow	Scale low value	float32	180a	6154	Set by Channel.1.Main.Resolution
Channel.1.Main.ScaleLow2	Scale low value for the secondary input	float32	181a	6170	Set by Channel.1.Main.Resolution
Channel.1.Main.SensorBreakType	Sensor break type: 0 = Off; 1 = Low; 2 = High	uint8	180f	6159	Not applicable
Channel.1.Main.SensorBreakVal	Sensor break value	uint8	1811	6161	Not applicable
Channel.1.Main.Shunt	Shunt value (Ohms)	float32	1805	6149	2dp
Channel.1.Main.Status	The PV (output) status 0 = Good 1 = Off 2 = Over range 3 = Under range 4 = HW error 5 = Ranging 6 = Overflow 7 = bad 8 = HW exceeded 9 = No data 12 = Comm channel error	uint8	0101	257	Not applicable
Channel.1.Main.Status2	The secondary input PV (output) status (as above)	uint8	0111	273	Not applicable
Channel.1.Main.TestSignal	Channel test waveform 0 = Triangle 5hr 1 = Triangle 40 min 2 = Triangle 4 min 3 = Triangle 40 sec 4 = Sine 5 hr 5 = Sine 40 min 6 = Sine 4 min 7 = Sine 40 sec	uint8	1802	6146	Not applicable
Channel.1.Main.Type	Specifies the type of channel 0 = Off 1 = TC 2 = mV 3 = V 4 = mA 5 = RTD 6 = Digital 7 = Test 8 = Ohms 9 = Dual mV 10 = Dual mA 11 = Dual TC	uint8	1800	6144	Not applicable
Channel.1.Main.Units	Units descriptor	string_t	4915	18709	Not applicable
Channel.1.Trend.Colour	Configures the trend colour for this channel 0 = Red 1 = Blue 2 = Green 3 = Honey 4 = Violet 5 = Russet 6 = Dark blue 7 = Jade 8 = Magenta 9 = Dusky rose 10 = Yellow 11 = Powder blue 12 = Dark red 13 = Avocado 14 = Indigo 15 = Dark brown 16 = Aegean 17 = Cyan 18 = Aubergine 19 = Dark orange 20 = Pale yellow 21 = Hyacinth 22 = Dark green 23 = Sugar pink 24 = Bluebell 25 = Orange 26 = Pink 27 = Buttersilk 28 = Terracotta 29 = Blue babe 30 = Lime 31 = Blue jive 32 = Cucumber 33 = Eurogreen 34 = Wheatgerm 35 = Sea Blue 36 = Ginger 37 = Aqua pool 38 = Pale red 39 = Pale blue 40 = Lilac 41 = Sky blue 42 = Wild moss 43 = Turquoise 44 = Pale green 45 = Coffee 49 = Dark Grey 53 = Light grey	uint8	1820	6176	Not applicable
Channel.1.Trend.SpanHigh	Specifies the highest PV (output value) to be displayed	float32	1822	6178	Same as Channel.1.Main.PV
Channel.1.Trend.SpanLow	Specifies the lowest PV (output value) to be displayed	float32	1821	6177	Same as Channel.1.Main.PV

Parameter path	Description	Type	Hex	Dec	Resolution
Channel.2.Alarm1.Acknowledgement	1 = alarm acknowledged	bool	18d0	6352	Not applicable
Channel.2.Alarm1.Active	1 = alarm source active, or safe but not ack'd	bool	18cb	6347	Not applicable
Channel.2.Alarm1.Amount	Rate-of-change alarm 'Amount'	float32	18c8	6344	Same as Channel.2.Main.PV
Channel.2.Alarm1.AverageTime	Rate-of-change alarm 'Average time'	time_t	18ca	6346	Set by Network.Modbus.TimeFormat
Channel.2.Alarm1.Block	0 = Blocking alarms off; 1 = Blocking alarms on	uint8	18c2	6338	Not applicable
Channel.2.Alarm1.ChangeTime	Rate-of-change alarm 'Change Time'	uint8	18c9	6345	Not applicable
Channel.2.Alarm1.Deviation	Deviation alarm 'Deviation Value'	float32	18c7	6343	Same as Channel.2.Main.PV
Channel.2.Alarm1.Dwell	Alarm dwell time	time_t	18c5	6341	Set by Network.Modbus.TimeFormat
Channel.2.Alarm1.Hysteresis	Alarm hysteresis value	float32	18c4	6340	Same as Channel.2.Main.PV
Channel.2.Alarm1.Inactive	1 = alarm source safe and ack'd (if necessary)	bool	18ce	6350	Not applicable
Channel.2.Alarm1.Inhibit	1 = Alarm inhibited	bool	18d1	6353	Not applicable
Channel.2.Alarm1.Latch	Alarm latch type (as for Channel.1.Alarm1)	uint8	18c1	6337	Not applicable
Channel.2.Alarm1.NotAcknowledged	1 = alarm has not been acknowledged	bool	18cf	6351	Not applicable
Channel.2.Alarm1.Reference	Deviation alarm 'Reference' value	float32	18c6	6342	Same as Channel.2.Main.PV
Channel.2.Alarm1.Status	Alarm status (as for Channel.1.Alarm1)	uint8	0106	262	Not applicable
Channel.2.Alarm1.Threshold	Alarm trigger threshold	float32	18c3	6339	Same as Channel.2.Main.PV
Channel.2.Alarm1.Type	Alarm type (as for Channel.1.Alarm1)	uint8	18c0	6336	Not applicable
Channel.2.Alarm2.Acknowledge	1 = acknowledge alarm	bool	01b3	435	Not applicable
Channel.2.Alarm2.Acknowledgement	1 = alarm acknowledged	bool	18f0	6384	Not applicable
Channel.2.Alarm2.Active	1 = alarm source active, or safe but not ack'd	bool	18eb	6379	Not applicable
Channel.2.Alarm2.Amount	Rate-of-change alarm 'Amount'	float32	18e8	6376	Same as Channel.2.Main.PV
Channel.2.Alarm2.AverageTime	Rate-of-change alarm 'Average time'	time_t	18ea	6378	Set by Network.Modbus.TimeFormat
Channel.2.Alarm2.Block	0 = Blocking alarms off; 1 = Blocking alarms on	uint8	18e2	6370	Not applicable
Channel.2.Alarm2.ChangeTime	Rate-of-change alarm 'Change Time'	uint8	18e9	6377	Not applicable
Channel.2.Alarm2.Deviation	Deviation alarm 'Deviation Value'	float32	18e7	6375	Same as Channel.2.Main.PV
Channel.2.Alarm2.Dwell	Alarm dwell time	time_t	18e5	6373	Set by Network.Modbus.TimeFormat
Channel.2.Alarm2.Hysteresis	Alarm hysteresis value	float32	18e4	6372	Same as Channel.2.Main.PV
Channel.2.Alarm2.Inactive	1 = alarm source safe and ack'd (if necessary)	bool	18ee	6382	Not applicable
Channel.2.Alarm2.Inhibit	1 = Alarm inhibited	bool	18f1	6385	Not applicable
Channel.2.Alarm2.Latch	Alarm latch type (as for Channel.1.Alarm1)	uint8	18e1	6369	Not applicable
Channel.2.Alarm2.NotAcknowledged	1 = alarm has not been acknowledged	bool	18ef	6383	Not applicable
Channel.2.Alarm2.Reference	Deviation alarm 'Reference' value	float32	18e6	6374	Same as Channel.2.Main.PV
Channel.2.Alarm2.Status	Alarm status (as for Channel.1.Alarm1)	uint8	0107	263	Not applicable
Channel.2.Alarm2.Threshold	Alarm trigger threshold	float32	18e3	6371	Same as Channel.2.Main.PV
Channel.2.Alarm2.Type	Alarm type (as for Channel.1.Alarm1)	uint8	18e0	6368	Not applicable
Channel.2.Main.CJType	Cold junction compensation type (as for Channel.1.Main)	uint8	188c	6284	Not applicable
Channel.2.Main.CloseString	Close String	string_t	4999	18841	Not applicable
Channel.2.Main.Descriptor	Text string to describe the channel	string_t	491b	18715	Not applicable
Channel.2.Main.ExtCJTemp	External CJ temperature	float32	188d	6285	1dp
Channel.2.Main.FaultResponse	Input fault response	uint8	1890	6288	Not applicable
Channel.2.Main.Filter	Filter time constant	float32	188e	6286	1dp
Channel.2.Main.InputHigh	Input range high value	float32	1884	6276	1dp
Channel.2.Main.InputLow	Input range low value	float32	1883	6275	1dp
Channel.2.Main.InternalCJTemp	Channel 2 internal cold junction temperature	float32	1895	6293	1dp
Channel.2.Main.IPADjustState	Input Adjust state (0 = Unadjusted; 1 = Adjusted)	bool	1896	6294	Not applicable
Channel.2.Main.IPADjustState2	Secondary Input Adjust state (0 = Unadjusted; 1 = Adjusted)	bool	189c	6300	Not applicable
Channel.2.Main.LinType	Linearisation type (as for Channel.1.Main)	uint8	1886	6278	Not applicable
Channel.2.Main.MeasuredValue	Input value before linearisation, scaling, adjust etc.	float32	1894	6292	Set by Channel.2.Main.Resolution
Channel.2.Main.MeasuredValue2	Measured value of the secondary input	float32	1899	6297	Set by Channel.2.Main.Resolution
Channel.2.Main.Offset	Fixed value to be added to/subtracted from PV	float32	1897	6295	3dp
Channel.2.Main.Offset2	Secondary input offset	float32	1898	6296	3dp
Channel.2.Main.OpenString	Open String	string_t	4975	18805	Not applicable
Channel.2.Main.PV	The output (displayed) value of the channel.	float32	0104	260	Set by Channel.2.Main.Resolution
Channel.2.Main.PV2	The secondary input process variable (output) of the channel	float32	0114	276	Set by Channel.2.Main.Resolution
Channel.2.Main.RangeHigh	Range high value	float32	1888	6280	Set by Channel.2.Main.Resolution
Channel.2.Main.RangeLow	Range low value	float32	1887	6279	Set by Channel.2.Main.Resolution
Channel.2.Main.RangeUnits	Range units (as channel.1.Main)	uint8	1889	6281	Not applicable
Channel.2.Main.Resolution	Specifies the resolution/number of decimal places	uint8	1881	6273	Not applicable
Channel.2.Main.ScaleHigh	Scale high value	float32	188b	6283	Set by Channel.2.Main.Resolution
Channel.2.Main.ScaleHigh2	Scale high value for the secondary input	float32	189b	6299	Set by Channel.2.Main.Resolution

Parameter path	Description	Type	Hex	Dec	Resolution
Channel.2.Main.ScaleLow2	Scale low value for the secondary input	float32	189a	6298	Set by Channel.2.Main.Resolution
Channel.2.Main.SensorBreakType	Sensor break type (as for Channel.1.Main)	uint8	188f	6287	Not applicable
Channel.2.Main.SensorBreakVal	Sensor break value	uint8	1891	6289	Not applicable
Channel.2.Main.Shunt	Shunt value in Ohms	float32	1885	6277	2dp
Channel.2.Main.Status	Channel status (as for Channel.1.Main.Status)	uint8	0105	261	Not applicable
Channel.2.Main.Status2	The secondary input PV (output) status (as above)	uint8	0115	277	Not applicable
Channel.2.Main.TestSignal	Channel test waveform (as for Channel.1.Main)	uint8	1882	6274	Not applicable
Channel.2.Main.Type	Channel function (as for Channel.1.Main.Type)	uint8	1880	6272	Not applicable
Channel.2.Main.Units	Channel units string	string_t	4930	18736	Not applicable
Channel.2.Trend.Colour	Trend colour (as for Channel.1.Trend.Colour)	uint8	18a0	6304	Not applicable
Channel.2.Trend.SpanHigh	Specifies the highest PV (output value) to be displayed	float32	18a2	6306	Same as Channel.2.Main.PV
Channel.2.Trend.SpanLow	Specifies the lowest PV (output value) to be displayed	float32	18a1	6305	Same as Channel.2.Main.PV
Channel.3.Alarm1.Acknowledgement	1 = alarm acknowledged	bool	1950	6480	Not applicable
Channel.3.Alarm1.Active	1 = alarm source active, or safe but not ack'd	bool	194b	6475	Not applicable
Channel.3.Alarm1.Amount	Rate-of-change alarm 'Amount'	float32	1948	6472	Same as Channel.3.Main.PV
Channel.3.Alarm1.AverageTime	Rate-of-change alarm 'Average time'	time_t	194a	6474	Set by Network.Modbus.TimeFormat
Channel.3.Alarm1.Block	0 = Blocking alarms off; 1 = Blocking alarms on.	uint8	1942	6466	Not applicable
Channel.3.Alarm1.ChangeTime	Rate-of-change alarm 'Change Time'	uint8	1949	6473	Not applicable
Channel.3.Alarm1.Deviation	Deviation alarm 'Deviation Value'	float32	1947	6471	Same as Channel.3.Main.PV
Channel.3.Alarm1.Dwell	Alarm dwell time	time_t	1945	6469	Set by Network.Modbus.TimeFormat
Channel.3.Alarm1.Hysteresis	Alarm hysteresis value	float32	1944	6468	Same as Channel.3.Main.PV
Channel.3.Alarm1.Inactive	1 = alarm source safe and ack'd (if necessary)	bool	194e	6478	Not applicable
Channel.3.Alarm1.Inhibit	1 = alarm inhibited	bool	1951	6481	Not applicable
Channel.3.Alarm1.Latch	Alarm latch type (as for Channel.1.Alarm1)	uint8	1941	6465	Not applicable
Channel.3.Alarm1.NotAcknowledged	1 = alarm has not been acknowledged	bool	194f	6479	Not applicable
Channel.3.Alarm1.Reference	Deviation alarm 'Reference' value	float32	1946	6470	Same as Channel.3.Main.PV
Channel.3.Alarm1.Status	Alarm status (as for Channel.1.Alarm1)	uint8	010a	266	Not applicable
Channel.3.Alarm1.Threshold	Alarm trigger threshold	float32	1943	6467	Same as Channel.3.Main.PV
Channel.3.Alarm1.Type	Alarm type (as for Channel.1.Alarm1)	uint8	1940	6464	Not applicable
Channel.3.Alarm2.Acknowledge	1 = acknowledge alarm	bool	01b5	437	Not applicable
Channel.3.Alarm2.Acknowledgement	1 = alarm acknowledged	bool	1970	6512	Not applicable
Channel.3.Alarm2.Active	1 = alarm source active, or safe but not ack'd	bool	196b	6507	Not applicable
Channel.3.Alarm2.Amount	Rate-of-change alarm 'Amount'	float32	1968	6504	Same as Channel.3.Main.PV
Channel.3.Alarm2.AverageTime	Rate-of-change alarm 'Average time'	time_t	196a	6506	Set by Network.Modbus.TimeFormat
Channel.3.Alarm2.Block	0 = Blocking alarms off; 1 = Blocking alarms on.	uint8	1962	6498	Not applicable
Channel.3.Alarm2.ChangeTime	Rate-of-change alarm 'Change Time'	uint8	1969	6505	Not applicable
Channel.3.Alarm2.Deviation	Deviation alarm 'Deviation Value'	float32	1967	6503	Same as Channel.3.Main.PV
Channel.3.Alarm2.Dwell	Alarm dwell time	time_t	1965	6501	Set by Network.Modbus.TimeFormat
Channel.3.Alarm2.Hysteresis	Alarm hysteresis value	float32	1964	6500	Same as Channel.3.Main.PV
Channel.3.Alarm2.Inactive	1 = alarm source safe and ack'd (if necessary)	bool	196e	6510	Not applicable
Channel.3.Alarm2.Inhibit	1 = Alarm inhibited	bool	1971	6513	Not applicable
Channel.3.Alarm2.Latch	Alarm latch type (as for Channel.1.Alarm1)	uint8	1961	6497	Not applicable
Channel.3.Alarm2.NotAcknowledged	1 = alarm has not been acknowledged	bool	196f	6511	Not applicable
Channel.3.Alarm2.Reference	Deviation alarm 'Reference' value	float32	1966	6502	Same as Channel.3.Main.PV
Channel.3.Alarm2.Status	Alarm status (as for Channel.1.Alarm1)	uint8	010b	267	Not applicable
Channel.3.Alarm2.Threshold	Alarm trigger threshold	float32	1963	6499	Same as Channel.3.Main.PV
Channel.3.Alarm2.Type	Alarm type (as for Channel.1.Alarm1)	uint8	1960	6496	Not applicable
Channel.3.Main.CJType	Cold junction compensation type (as for Channel.1.Main)	uint8	190c	6412	Not applicable
Channel.3.Main.CloseString	Close String	string_t	49a2	18850	Not applicable
Channel.3.Main.Descriptor	Text string to describe the channel	string_t	4936	18742	Not applicable
Channel.3.Main.ExtCJTemp	External CJ temperature	float32	190d	6413	1dp
Channel.3.Main.FaultResponse	Input fault response (As for Channel.1.Main)	uint8	1910	6416	Not applicable
Channel.3.Main.Filter	Filter time constant	float32	190e	6414	1dp
Channel.3.Main.InputHigh	Input range maximum value	float32	1904	6404	1dp
Channel.3.Main.InputLow	Input range minimum value	float32	1903	6403	1dp
Channel.3.Main.InternalCJTemp	Channel internal cold junction temperature	float32	1915	6421	1dp
Channel.3.Main.IPAdjustState	Input Adjust state (0 = Unadjusted; 1 = Adjusted)	bool	1916	6422	Not applicable
Channel.3.Main.IPAdjustState2	Secondary Input Adjust state (0 = Unadjusted; 1 = Adjusted)	bool	191c	6428	Not applicable
Channel.3.Main.LinType	Linearisation type (as for Channel.1.Main.LinType)	uint8	1906	6406	Not applicable
Channel.3.Main.MeasuredValue	Input value before linearisation, scaling, adjust etc.	float32	4944	6420	Set by Channel.2.Main.Resolution

Parameter path	Description	Type	Hex	Dec	Resolution
Channel.3.Main.Offset	Input offset	float32	1917	6423	3dp
Channel.3.Main.Offset2	Secondary input offset	float32	1918	6424	3dp
Channel.3.Main.OpenString	Open String	string_t	497e	18814	Not applicable
Channel.3.Main.PV	The output (displayed) value of the channel.	float32	0108	264	Set by Channel.3.Main.Resolution
Channel.3.Main.PV2	The secondary input process variable (output) of the channel	float32	0118	280	Set by Channel.3.Main.Resolution
Channel.3.Main.RangeHigh	Range high value	float32	1908	6408	Set by Channel.3.Main.Resolution
Channel.3.Main.RangeLow	Range low value	float32	1907	6407	Set by Channel.3.Main.Resolution
Channel.3.Main.RangeUnits	Range units	uint8	1909	6409	Not applicable
Channel.3.Main.Resolution	Specifies the resolution/number of decimal places	uint8	1901	6401	Not applicable
Channel.3.Main.ScaleHigh	Scale high value	float32	190b	6411	Set by Channel.3.Main.Resolution
Channel.3.Main.ScaleHigh2	Scale high value for the secondary input	float32	191b	6427	Set by Channel.3.Main.Resolution
Channel.3.Main.ScaleLow	Scale low value	float32	190a	6410	Set by Channel.3.Main.Resolution
Channel.3.Main.ScaleLow2	Scale low value for the secondary input	float32	191a	6426	Set by Channel.3.Main.Resolution
Channel.3.Main.SensorBreakType	Sensor break type (as for Channel.1.Main)	uint8	190f	6415	Not applicable
Channel.3.Main.SensorBreakVal	Sensor break value	uint8	1911	6417	Not applicable
Channel.3.Main.Shunt	Shunt value in Ohms	float32	1905	6405	2dp
Channel.3.Main.Status	Channel status (as for Channel.1.Main.Status)	uint8	0109	265	Not applicable
Channel.3.Main.Status2	The secondary input PV (output) status	uint8	0119	281	Not applicable
Channel.3.Main.TestSignal	Channel test waveform (as for Channel.1.Main)	uint8	1902	6402	Not applicable
Channel.3.Main.Type	Channel function (as for Channel.1.Main.Type)	uint8	1900	6400	Not applicable
Channel.3.Main.Units	Units descriptor	string_t	494b	18763	Not applicable
Channel.3.Trend.Colour	Trend colour (as for Channel.1.Trend.Colour)	uint8	1920	6432	Not applicable
Channel.3.Trend.SpanHigh	Specifies the highest PV (output value) to be displayed	float32	1922	6434	Same as Channel.3.Main.PV
Channel.3.Trend.SpanLow	Specifies the lowest PV (output value) to be displayed	float32	1921	6433	Same as Channel.3.Main.PV
Channel.4.Alarm1.Acknowledge	1 = acknowledge alarm	bool	01b6	438	Not applicable
Channel.4.Alarm1.Acknowledgement	1 = alarm acknowledged	bool	19d0	6608	Not applicable
Channel.4.Alarm1.Active	1 = alarm source active, or safe but not ack'd	bool	19cb	6603	Not applicable
Channel.4.Alarm1.Amount	Rate-of-change alarm 'Amount'	float32	19c8	6600	Same as Channel.4.Main.PV
Channel.4.Alarm1.AverageTime	Rate-of-change alarm 'Average time'	time_t	19ca	6602	Set by Network.Modbus.TimeFormat
Channel.4.Alarm1.Block	0 = Blocking alarms off; 1 = Blocking alarms on.	uint8	19c2	6594	Not applicable
Channel.4.Alarm1.ChangeTime	Rate-of-change alarm 'Change Time'	uint8	19c9	6601	Not applicable
Channel.4.Alarm1.Deviation	Deviation alarm 'Deviation Value'	float32	19c7	6599	Same as Channel.4.Main.PV
Channel.4.Alarm1.Dwell	Alarm dwell time	time_t	19c5	6597	Set by Network.Modbus.TimeFormat
Channel.4.Alarm1.Hysteresis	Alarm hysteresis value	float32	19c4	6596	Same as Channel.4.Main.PV
Channel.4.Alarm1.Inactive	1 = alarm source safe and ack'd (if necessary)	bool	19ce	6606	Not applicable
Channel.4.Alarm1.Inhibit	1 = alarm inhibited	bool	19d1	6609	Not applicable
Channel.4.Alarm1.Latch	Alarm latch type (as for Channel.1.Alarm1)	uint8	19c1	6593	Not applicable
Channel.4.Alarm1.NotAcknowledged	1 = alarm has not been acknowledged	bool	19cf	6607	Not applicable
Channel.4.Alarm1.Reference	Deviation alarm 'Reference' value	float32	19c6	6598	Same as Channel.4.Main.PV
Channel.4.Alarm1.Status	Alarm status (as for Channel.1.Alarm1)	uint8	010e	270	Not applicable
Channel.4.Alarm1.Threshold	Alarm trigger threshold	float32	19c3	6595	Same as Channel.4.Main.PV
Channel.4.Alarm1.Type	Alarm type (as for Channel.1.Alarm1)	uint8	19c0	6592	Not applicable
Channel.4.Alarm2.Acknowledge	1 = acknowledge alarm	bool	01b7	439	Not applicable
Channel.4.Alarm2.Acknowledgement	1 = alarm acknowledged	bool	19f0	6640	Not applicable
Channel.4.Alarm2.Active	1 = alarm source active, or safe but not ack'd	bool	19eb	6635	Not applicable
Channel.4.Alarm2.Amount	Rate-of-change alarm 'Amount'	float32	19e8	6632	Same as Channel.4.Main.PV
Channel.4.Alarm2.AverageTime	Rate-of-change alarm 'Average time'	time_t	19ea	6634	Set by Network.Modbus.TimeFormat
Channel.4.Alarm2.Block	0 = Blocking alarms off; 1 = Blocking alarms on	uint8	19e2	6626	Not applicable
Channel.4.Alarm2.ChangeTime	Rate-of-change alarm 'Change Time'	uint8	19e9	6633	Not applicable
Channel.4.Alarm2.Deviation	Deviation alarm 'Deviation Value'	float32	19e7	6631	Same as Channel.4.Main.PV
Channel.4.Alarm2.Dwell	Alarm dwell time	time_t	19e5	6629	Set by Network.Modbus.TimeFormat
Channel.4.Alarm2.Hysteresis	Alarm hysteresis value	float32	19e4	6628	Same as Channel.4.Main.PV
Channel.4.Alarm2.Inactive	1 = alarm source safe and ack'd (if necessary)	bool	19ee	6638	Not applicable
Channel.4.Alarm2.Latch	Alarm latch type (as for Channel.1.Alarm1)	uint8	19e1	6625	Not applicable
Channel.4.Alarm2.NotAcknowledged	1 = alarm has not been acknowledged	bool	19ef	6639	Not applicable
Channel.4.Alarm2.Reference	Deviation alarm 'Reference' value	float32	19e6	6630	Same as Channel.4.Main.PV
Channel.4.Alarm2.Status	Alarm status (as for Channel.1.Alarm1)	uint8	010f	271	Not applicable
Channel.4.Alarm2.Threshold	Alarm trigger threshold	float32	19e3	6627	Same as Channel.4.Main.PV
Channel.4.Alarm2.Type	Alarm type (as for Channel.1.Alarm1)	uint8	19e0	6624	Not applicable

Parameter path	Description	Type	Hex	Dec	Resolution
Channel.4.Main.CloseString	Close String	string_t	49ab	18859	Not applicable
Channel.4.Main.Descriptor	Text string to describe the channel	string_t	4951	18769	Not applicable
Channel.4.Main.ExtCJTemp	External CJ temperature	float32	198d	6541	1dp
Channel.4.Main.FaultResponse	Input fault response (as for Channel.1.Main)	uint8	1990	6544	Not applicable
Channel.4.Main.Filter	Filter time constant	float32	198e	6542	1dp
Channel.4.Main.InputHigh	Input range maximum value	float32	1984	6532	1dp
Channel.4.Main.InputLow	Input range minimum value	float32	1983	6531	1dp
Channel.4.Main.InternalCJTTemp	Channel internal cold junction temperature	float32	1995	6549	1dp
Channel.4.Main.IPADjustState	Input Adjust state (0 = Unadjusted;1 =Adjusted)	bool	1996	6550	Not applicable
Channel.4.Main.IPADjustState2	Secondary Input Adjust state (0 = Unadjusted; 1 = Adjusted)	bool	199c	6556	Not applicable
Channel.4.Main.LinType	Linearisation type (as for Channel.1.Main.LinType)	uint8	1986	6534	Not applicable
Channel.4.Main.MeasuredValue	Input value before linearisation, scaling, adjust etc.	float32	1994	6548	Set by Channel.4.Main.Resolution
Channel.4.Main.MeasuredValue2	Measured value of the secondary input	float32	1999	6553	Set by Channel.4.Main.Resolution
Channel.4.Main.Offset	Fixed value to be added to/subtracted from PV	float32	1997	6551	3dp
Channel.4.Main.Offset2	Secondary input offset	float32	1998	6552	3dp
Channel.4.Main.OpenString	Open String	string_t	4987	18823	Not applicable
Channel.4.Main.PV	The output (displayed) value of the channel.	float32	010c	268	Set by Channel.4.Main.Resolution
Channel.4.Main.PV2	The secondary input process variable (output) of the channel	float32	011c	284	Set by Channel.4.Main.Resolution
Channel.4.Main.RangeHigh	Range high value	float32	1988	6536	Set by Channel.4.Main.Resolution
Channel.4.Main.RangeLow	Range low value	float32	1987	6535	Set by Channel.4.Main.Resolution
Channel.4.Main.RangeUnits	Range units (as channel.1.Main.RangeUnits)	uint8	1989	6537	Not applicable
Channel.4.Main.Resolution	Specifies the resolution/number of decimal places	uint8	1981	6529	Not applicable
Channel.4.Main.ScaleHigh	Scale high value	float32	198b	6539	Set by Channel.4.Main.Resolution
Channel.4.Main.ScaleHigh2	Scale high value for the secondary input	float32	199b	6555	Set by Channel.4.Main.Resolution
Channel.4.Main.ScaleLow	Scale low value	float32	198a	6538	Set by Channel.4.Main.Resolution
Channel.4.Main.ScaleLow2	Scale low value for the secondary input	float32	199a	6554	Set by Channel.4.Main.Resolution
Channel.4.Main.SensorBreakType	Sensor break type (as for Channel.1.Main)	uint8	198f	6543	Not applicable
Channel.4.Main.SensorBreakVal	Sensor break value	uint8	1991	6545	Not applicable
Channel.4.Main.Shunt	Shunt value in Ohms	float32	1985	6533	2dp
Channel.4.Main.Status	Channel status (as for Channel.1.Main.Status)	uint8	010d	269	Not applicable
Channel.4.Main.Status2	The secondary input PV (output) status	uint8	011d	285	Not applicable
Channel.4.Main.TestSignal	Channel test waveform (as for Channel.1.Main.TestSignal)	uint8	1982	6530	Not applicable
Channel.4.Main.Type	Channel function (as for Channel.1.Main.Type)	uint8	1980	6528	Not applicable
Channel.4.Main.Units	Units descriptor	string_t	4966	18790	Not applicable
Channel.4.Trend.Colour	Trend colour (as for Channel.1.Trend.Colour)	uint8	19a0	6560	Not applicable
Channel.4.Trend.SpanHigh	Specifies the highest PV (output value) to be displayed	float32	19a2	6562	Same as Channel.4.Main.PV
Channel.4.Trend.SpanLow	Specifies the lowest PV (output value) to be displayed	float32	19a1	6561	Same as Channel.4.Main.PV
CustomMessage.Message1	Custom message No 1	string_t	5e00	24064	Not applicable
CustomMessage.Message2	Custom message No 2	string_t	5e65	24165	Not applicable
CustomMessage.Message3	Custom message No 3	string_t	5eca	24266	Not applicable
CustomMessage.Message4	Custom message No 4	string_t	5f2f	24367	Not applicable
CustomMessage.Message5	Custom message No 5	string_t	5f94	24468	Not applicable
CustomMessage.Message6	Custom message No 6	string_t	5ff9	24569	Not applicable
CustomMessage.Message7	Custom message No 7	string_t	605e	24670	Not applicable
CustomMessage.Message8	Custom message No 8	string_t	60c3	24771	Not applicable
CustomMessage.Message9	Custom message No 9	string_t	6128	24872	Not applicable
CustomMessage.Message10	Custom message No 10	string_t	618d	24973	Not applicable
CustomMessage.Trigger1	Trigger for custom message No 1	bool	28f0	10480	Not applicable
CustomMessage.Trigger2	Trigger for custom message No 2	bool	28f1	10481	Not applicable
CustomMessage.Trigger3	Trigger for custom message No 3	bool	28f2	10482	Not applicable
CustomMessage.Trigger4	Trigger for custom message No 4	bool	28f3	10483	Not applicable
CustomMessage.Trigger5	Trigger for custom message No 5	bool	28f4	10484	Not applicable
CustomMessage.Trigger6	Trigger for custom message No 6	bool	28f5	10485	Not applicable
CustomMessage.Trigger7	Trigger for custom message No 7	bool	28f6	10486	Not applicable
CustomMessage.Trigger8	Trigger for custom message No 8	bool	28f7	10487	Not applicable
CustomMessage.Trigger9	Trigger for custom message No 9	bool	28f8	10488	Not applicable
CustomMessage.Trigger10	Trigger for custom message No 10	bool	28f9	10489	Not applicable
DCOutput.1A1B_DCOP.FallbackPV	Fallback PV value	float32	15c9	5577	Set by DCOutput.1A1B_DCOP.Resolution

Parameter path	Description	Type	Hex	Dec	Resolution
DCOutput.1A1B_DCOP.OPAdjustState	0 = Unadjusted, 1 = Adjusted	bool	15c3	5571	Not applicable
DCOutput.1A1B_DCOP.OutputHigh	DC Output High value	float32	15c6	5574	2dp
DCOutput.1A1B_DCOP.OutputLow	DC Output Low value	float32	15c5	5573	2dp
DCOutput.1A1B_DCOP.PV	DC Output PV	float32	15c1	5569	Set by DCOutput.1A1B_DCOP.Resolution
DCOutput.1A1B_DCOP.Resolution	Specifies the resolution/number of decimal places	uint8	15c4	5572	Not applicable
DCOutput.1A1B_DCOP.ScaleHigh	Scale High value	float32	15c8	5576	Set by DCOutput.1A1B_DCOP.Resolution
DCOutput.1A1B_DCOP.ScaleLow	Scale Low value	float32	15c7	5575	Set by DCOutput.1A1B_DCOP.Resolution
DCOutput.1A1B_DCOP.Status	PV Status 0 = Good 1 = Off 2 = Over range 3 = Under range 4 = HW error 5 = Ranging 6 = Overflow 7 = Bad 8 = HW exceeded 9 = No data	uint8	15c2	5570	Not applicable
DCOutput.1A1B_DCOP.Type	DC Output Type (0 = Volts; 1 = mA)	uint8	15c0	5568	Not applicable
DCOutput.2A2B_DCOP.FallbackPV	Fallback PV value	float32	15b9	5561	Set by DCOutput.2A2B_DCOP.Resolution
DCOutput.2A2B_DCOP.MeasuredValue	Measured Value	float32	15ba	5562	2dp
DCOutput.2A2B_DCOP.OPAdjustState	0 = Unadjusted, 1 = Adjusted	bool	15b3	5555	Not applicable
DCOutput.2A2B_DCOP.OutputHigh	DC Output High value	float32	15b6	5558	2dp
DCOutput.2A2B_DCOP.OutputLow	DC Output Low value	float32	15b5	5557	2dp
DCOutput.2A2B_DCOP.PV	DC Output PV	float32	15b1	5553	Set by DCOutput.2A2B_DCOP.Resolution
DCOutput.2A2B_DCOP.Resolution	Specifies the resolution/number of decimal places	uint8	15b4	5556	Not applicable
DCOutput.2A2B_DCOP.ScaleHigh	Scale High value	float32	15b8	5560	Set by DCOutput.2A2B_DCOP.Resolution
DCOutput.2A2B_DCOP.ScaleLow	Scale Low value	float32	15b7	5559	Set by DCOutput.2A2B_DCOP.Resolution
DCOutput.2A2B_DCOP.Status	PV Status (as DCOutput.1A1B_DCOP.Status)	uint8	15b2	5554	Not applicable
DCOutput.2A2B_DCOP.Type	DC Output Type (0 = Volts; 1 = mA)	uint8	15b0	5552	Not applicable
DCOutput.3A3B_DCOP.FallbackPV	Fallback PV value	float32	15a9	5545	Set by DCOutput.3A3B_DCOP.Resolution
DCOutput.3A3B_DCOP.MeasuredValue	Measured Value	float32	15aa	5546	2dp
DCOutput.3A3B_DCOP.OPAdjustState	0 = Unadjusted, 1 = Adjusted	bool	15a3	5539	Not applicable
DCOutput.3A3B_DCOP.OutputHigh	DC Output High value	float32	15a6	5542	2dp
DCOutput.3A3B_DCOP.OutputLow	DC Output Low value	float32	15a5	5541	2dp
DCOutput.3A3B_DCOP.PV	DC Output PV	float32	15a1	5537	Set by DCOutput.3A3B_DCOP.Resolution
DCOutput.3A3B_DCOP.Resolution	Specifies the resolution/number of decimal places	uint8	15a4	5540	Not applicable
DCOutput.3A3B_DCOP.ScaleHigh	Scale High value	float32	15a8	5544	Set by DCOutput.3A3B_DCOP.Resolution
DCOutput.3A3B_DCOP.ScaleLow	Scale Low value	float32	15a7	5543	Set by DCOutput.3A3B_DCOP.Resolution
DCOutput.3A3B_DCOP.Status	PV Status (as DCOutput.1A1B_DCOP.Status)	uint8	15a2	5538	Not applicable
DCOutput.3A3B_DCOP.Type	DC Output Type (0 = Volts; 1 = mA)	uint8	15a0	5536	Not applicable
DigitalIO.1A1B.Backlash	Valve positioning backlash compensation (seconds)	float32	1508	5384	1dp
DigitalIO.1A1B.Inertia	Inertia value for the valve	float32	1507	5383	1dp
DigitalIO.1A1B.Invert	1 = Invert; 0 = Do not invert	bool	1503	5379	Not applicable
DigitalIO.1A1B.MinOnTime	Time proportioned output minimum on time	float32	1502	5378	2dp
DigitalIO.1A1B.ModuleIdent	Module Identification 0 = Digital I/O 1 = Relay output 2 = Triac output 3 = Digital input 4 = Digital output	uint8	150a	5386	Not applicable
DigitalIO.1A1B.Output	0 = Output off, 1 = Output on	bool	1504	5380	Not applicable
DigitalIO.1A1B.PV	For contact inputs, 0 = Open, 1 = Closed. For On Off outputs, <0.5 = Drive low, else drive high For Time Proportional outputs, PV = demanded output %	float32	1501	5377	0dp
DigitalIO.1A1B.StandbyAction	Valve positioning standby action (0 = Continue; 1 = Freeze).	uint8	1509	5385	Not applicable
DigitalIO.1A1B.Type	Specifies the type of the digital input / output 0 = Contact closure input 1 = On Off output 2 = Time proportioning output 3 = Valve raise 4 = Valve lower	uint8	1500	5376	Not applicable
DigitalIO.2A2B.Backlash	Valve positioning backlash compensation (seconds)	float32	1518	5400	1dp
DigitalIO.2A2B.Inertia	Inertia value for the valve	float32	1517	5399	1dp
DigitalIO.2A2B.Invert	1 = Invert; 0 = Do not invert	bool	1513	5395	Not applicable
DigitalIO.2A2B.MinOnTime	Time proportioned output minimum on time	float32	1512	5394	2dp
DigitalIO.2A2B.ModuleIdent	As DigitalIO.1A1B.ModuleIdent	uint8	151a	5402	Not applicable
DigitalIO.2A2B.Output	0 = Output off, 1 = Output on	bool	1514	5396	Not applicable
DigitalIO.2A2B.PV	Digital I/O process value (as DigitalIO.1A1B.PV)	float32	1511	5393	0dp
DigitalIO.2A2B.StandbyAction	Valve positioning standby action (0 = Continue; 1 = Freeze).	uint8	1519	5401	Not applicable
DigitalIO.2A2B.Type	Digital I/O type (as DigitalIO.1A1B.Type).	uint8	1510	5392	Not applicable
DigitalIO.2A2B.Backlash	Valve positioning backlash compensation (seconds)	float32	1528	5420	1dp

Parameter path	Description	Type	Hex	Dec	Resolution
DigitalIO.3A3B.Invert	1 = Invert; 0 = Do not invert	bool	1533	5427	Not applicable
DigitalIO.3A3B.MinOnTime	Time proportioned output minimum on time	float32	1532	5426	2dp
DigitalIO.3A3B.ModuleIdent	As DigitalIO.1A1B.ModuleIdent	uint8	153a	5434	Not applicable
DigitalIO.3A3B.Output	0 = Output off, 1 = Output on	bool	1534	5428	Not applicable
DigitalIO.3A3B.PV	Digital I/O process value (as DigitalIO.1A1B.PV)	float32	1531	5425	0dp
DigitalIO.3A3B.StandbyAction	Valve positioning standby action (0 = Continue; 1 = Freeze).	uint8	1539	5433	Not applicable
DigitalIO.3A3B.Type	Digital I/O type (as DigitalIO.1A1B.Type).	uint8	1530	5424	Not applicable
DigitalIO.DI_LALC.Backlash	Valve positioning backlash compensation (seconds)	float32	1528	5416	1dp
DigitalIO.DI_LALC.Inertia	Inertia value for the valve	float32	1527	5415	1dp
DigitalIO.DI_LALC.Invert	1 = Invert; 0 = Do not invert	bool	1523	5411	Not applicable
DigitalIO.DI_LALC.MinOnTime	Time proportioned output minimum on time	float32	1522	5410	2dp
DigitalIO.DI_LALC.ModuleIdent	As DigitalIO.1A1B.ModuleIdent	uint8	152a	5418	Not applicable
DigitalIO.DI_LALC.Output	0 = Output off, 1 = Output on	bool	1524	5412	Not applicable
DigitalIO.DI_LALC.PV	Digital I/O process value (as DigitalIO.1A1B.PV)	float32	1521	5409	0dp
DigitalIO.DI_LALC.StandbyAction	Valve positioning standby action (0 = Continue; 1 = Freeze).	uint8	1529	5417	Not applicable
DigitalIO.DI_LALC.Type	Digital I/O type (as DigitalIO.1A1B.Type).	uint8	1520	5408	Not applicable
DigitalIO.DI_LBLC.Backlash	Valve positioning backlash compensation (seconds)	float32	1548	5448	1dp
DigitalIO.DI_LBLC.Inertia	Inertia value for the valve	float32	1547	5447	1dp
DigitalIO.DI_LBLC.Invert	1 = Invert; 0 = Do not invert	bool	1543	5443	Not applicable
DigitalIO.DI_LBLC.MinOnTime	Time proportioned output minimum on time	float32	1542	5442	2dp
DigitalIO.DI_LBLC.ModuleIdent	As DigitalIO.1A1B.ModuleIdent	uint8	154a	5450	Not applicable
DigitalIO.DI_LBLC.Output	0 = Output off, 1 = Output on	bool	1544	5444	Not applicable
DigitalIO.DI_LBLC.PV	Digital I/O process value (as DigitalIO.1A1B.PV)	float32	1541	5441	0dp
DigitalIO.DI_LBLC.StandbyAction	Valve positioning standby action (0 = Continue; 1 = Freeze).	uint8	1549	5449	Not applicable
DigitalIO.DI_LBLC.Type	Digital I/O type (as DigitalIO.1A1B.Type).	uint8	1540	5440	Not applicable
DigitalIO.RELAY_4AC.Backlash	Valve positioning backlash compensation (seconds)	float32	1558	5464	1dp
DigitalIO.RELAY_4AC.Inertia	Inertia value for the valve	float32	1557	5463	1dp
DigitalIO.RELAY_4AC.Invert	1 = Invert; 0 = Do not invert	bool	1553	5459	Not applicable
DigitalIO.RELAY_4AC.MinOnTime	Time proportioned output minimum on time	float32	1552	5458	2dp
DigitalIO.RELAY_4AC.ModuleIdent	As DigitalIO.1A1B.ModuleIdent	uint8	155a	5466	Not applicable
DigitalIO.RELAY_4AC.Output	0 = Output off, 1 = Output on	bool	1554	5460	Not applicable
DigitalIO.RELAY_4AC.PV	Digital I/O process value (as DigitalIO.1A1B.PV)	float32	1551	5457	0dp
DigitalIO.RELAY_4AC.StandbyAction	Valve positioning standby action (0 = Continue; 1 = Freeze).	uint8	1559	5465	Not applicable
DigitalIO.RELAY_4AC.Type	Digital I/O type (as DigitalIO.1A1B.Type).	uint8	1550	5456	Not applicable
DigitalIO.RELAY_5AC.Backlash	Valve positioning backlash compensation (seconds)	float32	1568	5480	1dp
DigitalIO.RELAY_5AC.Inertia	Inertia value for the valve	float32	1567	5479	1dp
DigitalIO.RELAY_5AC.Invert	1 = Invert; 0 = Do not invert	bool	1563	5475	Not applicable
DigitalIO.RELAY_5AC.MinOnTime	Time proportioned output minimum on time	float32	1562	5474	2dp
DigitalIO.RELAY_5AC.ModuleIdent	As DigitalIO.1A1B.ModuleIdent	uint8	156a	5482	Not applicable
DigitalIO.RELAY_5AC.Output	0 = Output off, 1 = Output on	bool	1564	5476	Not applicable
DigitalIO.RELAY_5AC.PV	Digital I/O process value (as DigitalIO.1A1B.PV)	float32	1561	5473	0dp
DigitalIO.RELAY_5AC.StandbyAction	Valve positioning standby action (0 = Continue; 1 = Freeze).	uint8	1569	5481	Not applicable
DigitalIO.RELAY_5AC.Type	Digital I/O type (as DigitalIO.1A1B.Type).	uint8	1560	5472	Not applicable
EthernetIP.ImplicitInputs.Input1	Read only input from an EtherNet/IP client	eint32	7e66	32358	Not applicable
EthernetIP.ImplicitInputs.Input2	See input 1 for details	eint32	7e6a	32362	Not applicable
EthernetIP.ImplicitInputs.Input3	See input 1 for details	eint32	7e6e	32366	Not applicable
EthernetIP.ImplicitInputs.Input4	See input 1 for details	eint32	7e72	32370	Not applicable
EthernetIP.ImplicitInputs.Input5	See input 1 for details	eint32	7e76	32374	Not applicable
EthernetIP.ImplicitInputs.Input6	See input 1 for details	eint32	7e7a	32378	Not applicable
EthernetIP.ImplicitInputs.Input7	See input 1 for details	eint32	7e7e	32382	Not applicable
EthernetIP.ImplicitInputs.Input8	See input 1 for details	eint32	7e82	32386	Not applicable
EthernetIP.ImplicitInputs.Input9	See input 1 for details	eint32	7e86	32390	Not applicable
EthernetIP.ImplicitInputs.Input10	See input 1 for details	eint32	7e8a	32394	Not applicable
EthernetIP.ImplicitInputs.Input11	See input 1 for details	eint32	7e8e	32398	Not applicable
EthernetIP.ImplicitInputs.Input12	See input 1 for details	eint32	7e92	32402	Not applicable
EthernetIP.ImplicitInputs.Input13	See input 1 for details	eint32	7e96	32406	Not applicable

Parameter path	Description	Type	Hex	Dec	Resolution
EthernetIP.ImplicitInputs.Input15	See input 1 for details	eint32	7e9e	32414	Not applicable
EthernetIP.ImplicitInputs.Input16	See input 1 for details	eint32	7ea2	32418	Not applicable
EthernetIP.ImplicitInputs.Input17	See input 1 for details	eint32	7ea6	32422	Not applicable
EthernetIP.ImplicitInputs.Input18	See input 1 for details	eint32	7eaa	32426	Not applicable
EthernetIP.ImplicitInputs.Input19	See input 1 for details	eint32	7eae	32430	Not applicable
EthernetIP.ImplicitInputs.Input20	See input 1 for details	eint32	7eb2	32434	Not applicable
EthernetIP.ImplicitInputs.Input21	See input 1 for details	eint32	7eb6	32438	Not applicable
EthernetIP.ImplicitInputs.Input22	See input 1 for details	eint32	7eba	32442	Not applicable
EthernetIP.ImplicitInputs.Input23	See input 1 for details	eint32	7ebe	32446	Not applicable
EthernetIP.ImplicitInputs.Input24	See input 1 for details	eint32	7ec2	32450	Not applicable
EthernetIP.ImplicitInputs.Input25	See input 1 for details	eint32	7ec6	32454	Not applicable
EthernetIP.ImplicitInputs.Input26	See input 1 for details	eint32	7eca	32458	Not applicable
EthernetIP.ImplicitInputs.Input27	See input 1 for details	eint32	7ece	32462	Not applicable
EthernetIP.ImplicitInputs.Input28	See input 1 for details	eint32	7ed2	32466	Not applicable
EthernetIP.ImplicitInputs.Input29	See input 1 for details	eint32	7ed6	32470	Not applicable
EthernetIP.ImplicitInputs.Input30	See input 1 for details	eint32	7eda	32474	Not applicable
EthernetIP.ImplicitInputs.Input31	See input 1 for details	eint32	7ede	32478	Not applicable
EthernetIP.ImplicitInputs.Input32	See input 1 for details	eint32	7ee2	32482	Not applicable
EthernetIP.ImplicitInputs.Input33	See input 1 for details	eint32	7ee6	32486	Not applicable
EthernetIP.ImplicitInputs.Input34	See input 1 for details	eint32	7eea	32490	Not applicable
EthernetIP.ImplicitInputs.Input35	See input 1 for details	eint32	7eee	32494	Not applicable
EthernetIP.ImplicitInputs.Input36	See input 1 for details	eint32	7ef2	32498	Not applicable
EthernetIP.ImplicitInputs.Input37	See input 1 for details	eint32	7ef6	32502	Not applicable
EthernetIP.ImplicitInputs.Input38	See input 1 for details	eint32	7efa	32506	Not applicable
EthernetIP.ImplicitInputs.Input39	See input 1 for details	eint32	7efe	32510	Not applicable
EthernetIP.ImplicitInputs.Input40	See input 1 for details	eint32	7f02	32514	Not applicable
EthernetIP.ImplicitInputs.Input41	See input 1 for details	eint32	7f06	32518	Not applicable
EthernetIP.ImplicitInputs.Input42	See input 1 for details	eint32	7f0a	32522	Not applicable
EthernetIP.ImplicitInputs.Input43	See input 1 for details	eint32	7f0e	32526	Not applicable
EthernetIP.ImplicitInputs.Input44	See input 1 for details	eint32	7f12	32530	Not applicable
EthernetIP.ImplicitInputs.Input45	See input 1 for details	eint32	7f16	32534	Not applicable
EthernetIP.ImplicitInputs.Input46	See input 1 for details	eint32	7f1a	32538	Not applicable
EthernetIP.ImplicitInputs.Input47	See input 1 for details	eint32	7f1e	32542	Not applicable
EthernetIP.ImplicitInputs.Input48	See input 1 for details	eint32	7f22	32546	Not applicable
EthernetIP.ImplicitInputs.Input49	See input 1 for details	eint32	7f26	32550	Not applicable
EthernetIP.ImplicitInputs.Input50	See input 1 for details	eint32	7f2a	32554	Not applicable
EthernetIP.ImplicitInputs.InputValue1	Value of the Input 1 parameter	int16	7e68	32360	Not applicable
EthernetIP.ImplicitInputs.InputValue2	See input 1 value for details	int16	7e6c	32364	Not applicable
EthernetIP.ImplicitInputs.InputValue3	See input 1 value for details	int16	7e70	32368	Not applicable
EthernetIP.ImplicitInputs.InputValue4	See input 1 value for details	int16	7e74	32372	Not applicable
EthernetIP.ImplicitInputs.InputValue5	See input 1 value for details	int16	7e78	32376	Not applicable
EthernetIP.ImplicitInputs.InputValue6	See input 1 value for details	int16	7e7c	32380	Not applicable
EthernetIP.ImplicitInputs.InputValue7	See input 1 value for details	int16	7e80	32384	Not applicable
EthernetIP.ImplicitInputs.InputValue8	See input 1 value for details	int16	7e84	32388	Not applicable
EthernetIP.ImplicitInputs.InputValue9	See input 1 value for details	int16	7e88	32392	Not applicable
EthernetIP.ImplicitInputs.InputValue10	See input 1 value for details	int16	7e8c	32396	Not applicable
EthernetIP.ImplicitInputs.InputValue11	See input 1 value for details	int16	7e90	32400	Not applicable
EthernetIP.ImplicitInputs.InputValue12	See input 1 value for details	int16	7e94	32404	Not applicable
EthernetIP.ImplicitInputs.InputValue13	See input 1 value for details	int16	7e98	32408	Not applicable
EthernetIP.ImplicitInputs.InputValue14	See input 1 value for details	int16	7e9c	32412	Not applicable
EthernetIP.ImplicitInputs.InputValue15	See input 1 value for details	int16	7ea0	32416	Not applicable
EthernetIP.ImplicitInputs.InputValue16	See input 1 value for details	int16	7ea4	32420	Not applicable
EthernetIP.ImplicitInputs.InputValue17	See input 1 value for details	int16	7ea8	32424	Not applicable
EthernetIP.ImplicitInputs.InputValue18	See input 1 value for details	int16	7eac	32428	Not applicable
EthernetIP.ImplicitInputs.InputValue19	See input 1 value for details	int16	7eb0	32432	Not applicable
EthernetIP.ImplicitInputs.InputValue20	See input 1 value for details	int16	7eb4	32436	Not applicable
EthernetIP.ImplicitInputs.InputValue21	See input 1 value for details	int16	7eb8	32440	Not applicable
EthernetIP.ImplicitInputs.InputValue22	See input 1 value for details	int16	7ebc	32444	Not applicable
EthernetIP.ImplicitInputs.InputValue23	See input 1 value for details	int16	7ec0	32448	Not applicable
EthernetIP.ImplicitInputs.InputValue24	See input 1 value for details	int16	7ec4	32452	Not applicable

Parameter path	Description	Type	Hex	Dec	Resolution
EthernetIP.ImplicitInputs.InputValue26	See input 1 value for details	int16	7ecc	32460	Not applicable
EthernetIP.ImplicitInputs.InputValue27	See input 1 value for details	int16	7ed0	32464	Not applicable
EthernetIP.ImplicitInputs.InputValue28	See input 1 value for details	int16	7ed4	32468	Not applicable
EthernetIP.ImplicitInputs.InputValue29	See input 1 value for details	int16	7ed8	32472	Not applicable
EthernetIP.ImplicitInputs.InputValue30	See input 1 value for details	int16	7edc	32476	Not applicable
EthernetIP.ImplicitInputs.InputValue31	See input 1 value for details	int16	7ee0	32480	Not applicable
EthernetIP.ImplicitInputs.InputValue32	See input 1 value for details	int16	7ee4	32484	Not applicable
EthernetIP.ImplicitInputs.InputValue33	See input 1 value for details	int16	7ee8	32488	Not applicable
EthernetIP.ImplicitInputs.InputValue34	See input 1 value for details	int16	7eec	32492	Not applicable
EthernetIP.ImplicitInputs.InputValue35	See input 1 value for details	int16	7ef0	32496	Not applicable
EthernetIP.ImplicitInputs.InputValue36	See input 1 value for details	int16	7ef4	32500	Not applicable
EthernetIP.ImplicitInputs.InputValue37	See input 1 value for details	int16	7ef8	32504	Not applicable
EthernetIP.ImplicitInputs.InputValue38	See input 1 value for details	int16	7efc	32508	Not applicable
EthernetIP.ImplicitInputs.InputValue39	See input 1 value for details	int16	7f00	32512	Not applicable
EthernetIP.ImplicitInputs.InputValue40	See input 1 value for details	int16	7f04	32516	Not applicable
EthernetIP.ImplicitInputs.InputValue41	See input 1 value for details	int16	7f08	32520	Not applicable
EthernetIP.ImplicitInputs.InputValue42	See input 1 value for details	int16	7f0c	32524	Not applicable
EthernetIP.ImplicitInputs.InputValue43	See input 1 value for details	int16	7f10	32528	Not applicable
EthernetIP.ImplicitInputs.InputValue44	See input 1 value for details	int16	7f14	32532	Not applicable
EthernetIP.ImplicitInputs.InputValue45	See input 1 value for details	int16	7f18	32536	Not applicable
EthernetIP.ImplicitInputs.InputValue46	See input 1 value for details	int16	7f1c	32540	Not applicable
EthernetIP.ImplicitInputs.InputValue47	See input 1 value for details	int16	7f20	32544	Not applicable
EthernetIP.ImplicitInputs.InputValue48	See input 1 value for details	int16	7f24	32548	Not applicable
EthernetIP.ImplicitInputs.InputValue49	See input 1 value for details	int16	7f28	32552	Not applicable
EthernetIP.ImplicitInputs.InputValue50	See input 1 value for details	int16	7f2c	32556	Not applicable
EthernetIP.ImplicitOutputs.Output1	Writeable output to the EtherNet/IP client	eint32	7f2e	32558	Not applicable
EthernetIP.ImplicitOutputs.Output2	See output 1 for details	eint32	7f32	32562	Not applicable
EthernetIP.ImplicitOutputs.Output3	See output 1 for details	eint32	7f36	32566	Not applicable
EthernetIP.ImplicitOutputs.Output4	See output 1 for details	eint32	7f3a	32570	Not applicable
EthernetIP.ImplicitOutputs.Output5	See output 1 for details	eint32	7f3e	32574	Not applicable
EthernetIP.ImplicitOutputs.Output6	See output 1 for details	eint32	7f42	32578	Not applicable
EthernetIP.ImplicitOutputs.Output7	See output 1 for details	eint32	7f46	32582	Not applicable
EthernetIP.ImplicitOutputs.Output8	See output 1 for details	eint32	7f4a	32586	Not applicable
EthernetIP.ImplicitOutputs.Output9	See output 1 for details	eint32	7f4e	32590	Not applicable
EthernetIP.ImplicitOutputs.Output10	See output 1 for details	eint32	7f52	32594	Not applicable
EthernetIP.ImplicitOutputs.Output11	See output 1 for details	eint32	7f56	32598	Not applicable
EthernetIP.ImplicitOutputs.Output12	See output 1 for details	eint32	7f5a	32602	Not applicable
EthernetIP.ImplicitOutputs.Output13	See output 1 for details	eint32	7f5e	32606	Not applicable
EthernetIP.ImplicitOutputs.Output14	See output 1 for details	eint32	7f62	32610	Not applicable
EthernetIP.ImplicitOutputs.Output15	See output 1 for details	eint32	7f66	32614	Not applicable
EthernetIP.ImplicitOutputs.Output16	See output 1 for details	eint32	7f6a	32618	Not applicable
EthernetIP.ImplicitOutputs.Output17	See output 1 for details	eint32	7f6e	32622	Not applicable
EthernetIP.ImplicitOutputs.Output18	See output 1 for details	eint32	7f72	32626	Not applicable
EthernetIP.ImplicitOutputs.Output19	See output 1 for details	eint32	7f76	32630	Not applicable
EthernetIP.ImplicitOutputs.Output20	See output 1 for details	eint32	7f7a	32634	Not applicable
EthernetIP.ImplicitOutputs.Output21	See output 1 for details	eint32	7f7e	32638	Not applicable
EthernetIP.ImplicitOutputs.Output22	See output 1 for details	eint32	7f82	32642	Not applicable
EthernetIP.ImplicitOutputs.Output23	See output 1 for details	eint32	7f86	32646	Not applicable
EthernetIP.ImplicitOutputs.Output24	See output 1 for details	eint32	7f8a	32650	Not applicable
EthernetIP.ImplicitOutputs.Output25	See output 1 for details	eint32	7f8e	32654	Not applicable
EthernetIP.ImplicitOutputs.Output26	See output 1 for details	eint32	7f92	32658	Not applicable
EthernetIP.ImplicitOutputs.Output27	See output 1 for details	eint32	7f96	32662	Not applicable
EthernetIP.ImplicitOutputs.Output28	See output 1 for details	eint32	7f9a	32666	Not applicable
EthernetIP.ImplicitOutputs.Output29	See output 1 for details	eint32	7f9e	32670	Not applicable
EthernetIP.ImplicitOutputs.Output30	See output 1 for details	eint32	7fa2	32674	Not applicable
EthernetIP.ImplicitOutputs.Output31	See output 1 for details	eint32	7fa6	32678	Not applicable
EthernetIP.ImplicitOutputs.Output32	See output 1 for details	eint32	7faa	32682	Not applicable
EthernetIP.ImplicitOutputs.Output33	See output 1 for details	eint32	7fae	32686	Not applicable
EthernetIP.ImplicitOutputs.Output34	See output 1 for details	eint32	7fb2	32690	Not applicable
EthernetIP.ImplicitOutputs.Output35	See output 1 for details	eint32	7fb6	32694	Not applicable

Parameter path	Description	Type	Hex	Dec	Resolution
EthernetIP.ImplicitOutputs.Output37	See output 1 for details	eint32	7fbe	32702	Not applicable
EthernetIP.ImplicitOutputs.Output38	See output 1 for details	eint32	7fc2	32706	Not applicable
EthernetIP.ImplicitOutputs.Output39	See output 1 for details	eint32	7fc6	32710	Not applicable
EthernetIP.ImplicitOutputs.Output40	See output 1 for details	eint32	7fca	32714	Not applicable
EthernetIP.ImplicitOutputs.Output41	See output 1 for details	eint32	7fce	32718	Not applicable
EthernetIP.ImplicitOutputs.Output42	See output 1 for details	eint32	7fd2	32722	Not applicable
EthernetIP.ImplicitOutputs.Output43	See output 1 for details	eint32	7fd6	32726	Not applicable
EthernetIP.ImplicitOutputs.Output44	See output 1 for details	eint32	7fda	32730	Not applicable
EthernetIP.ImplicitOutputs.Output45	See output 1 for details	eint32	7fde	32734	Not applicable
EthernetIP.ImplicitOutputs.Output46	See output 1 for details	eint32	7fe2	32738	Not applicable
EthernetIP.ImplicitOutputs.Output47	See output 1 for details	eint32	7fe6	32742	Not applicable
EthernetIP.ImplicitOutputs.Output48	See output 1 for details	eint32	7fea	32746	Not applicable
EthernetIP.ImplicitOutputs.Output49	See output 1 for details	eint32	7fee	32750	Not applicable
EthernetIP.ImplicitOutputs.Output50	See output 1 for details	eint32	7ff2	32754	Not applicable
EthernetIP.ImplicitOutputs.OutputValue1	Value of the Output 1 parameter	int16	7f30	32560	Not applicable
EthernetIP.ImplicitOutputs.OutputValue2	See output 1 value for details	int16	7f34	32564	Not applicable
EthernetIP.ImplicitOutputs.OutputValue3	See output 1 value for details	int16	7f38	32568	Not applicable
EthernetIP.ImplicitOutputs.OutputValue4	See output 1 value for details	int16	7f3c	32572	Not applicable
EthernetIP.ImplicitOutputs.OutputValue5	See output 1 value for details	int16	7f40	32576	Not applicable
EthernetIP.ImplicitOutputs.OutputValue6	See output 1 value for details	int16	7f44	32580	Not applicable
EthernetIP.ImplicitOutputs.OutputValue7	See output 1 value for details	int16	7f48	32584	Not applicable
EthernetIP.ImplicitOutputs.OutputValue8	See output 1 value for details	int16	7f4c	32588	Not applicable
EthernetIP.ImplicitOutputs.OutputValue9	See output 1 value for details	int16	7f50	32592	Not applicable
EthernetIP.ImplicitOutputs.OutputValue10	See output 1 value for details	int16	7f54	32596	Not applicable
EthernetIP.ImplicitOutputs.OutputValue11	See output 1 value for details	int16	7f58	32600	Not applicable
EthernetIP.ImplicitOutputs.OutputValue12	See output 1 value for details	int16	7f5c	32604	Not applicable
EthernetIP.ImplicitOutputs.OutputValue13	See output 1 value for details	int16	7f60	32608	Not applicable
EthernetIP.ImplicitOutputs.OutputValue14	See output 1 value for details	int16	7f64	32612	Not applicable
EthernetIP.ImplicitOutputs.OutputValue15	See output 1 value for details	int16	7f68	32616	Not applicable
EthernetIP.ImplicitOutputs.OutputValue16	See output 1 value for details	int16	7f6c	32620	Not applicable
EthernetIP.ImplicitOutputs.OutputValue17	See output 1 value for details	int16	7f70	32624	Not applicable
EthernetIP.ImplicitOutputs.OutputValue18	See output 1 value for details	int16	7f74	32628	Not applicable
EthernetIP.ImplicitOutputs.OutputValue19	See output 1 value for details	int16	7f78	32632	Not applicable
EthernetIP.ImplicitOutputs.OutputValue20	See output 1 value for details	int16	7f7c	32636	Not applicable
EthernetIP.ImplicitOutputs.OutputValue21	See output 1 value for details	int16	7f80	32640	Not applicable
EthernetIP.ImplicitOutputs.OutputValue22	See output 1 value for details	int16	7f84	32644	Not applicable
EthernetIP.ImplicitOutputs.OutputValue23	See output 1 value for details	int16	7f88	32648	Not applicable
EthernetIP.ImplicitOutputs.OutputValue24	See output 1 value for details	int16	7f8c	32652	Not applicable
EthernetIP.ImplicitOutputs.OutputValue25	See output 1 value for details	int16	7f90	32656	Not applicable
EthernetIP.ImplicitOutputs.OutputValue26	See output 1 value for details	int16	7f94	32660	Not applicable
EthernetIP.ImplicitOutputs.OutputValue27	See output 1 value for details	int16	7f98	32664	Not applicable
EthernetIP.ImplicitOutputs.OutputValue28	See output 1 value for details	int16	7f9c	32668	Not applicable
EthernetIP.ImplicitOutputs.OutputValue29	See output 1 value for details	int16	7fa0	32672	Not applicable
EthernetIP.ImplicitOutputs.OutputValue30	See output 1 value for details	int16	7fa4	32676	Not applicable
EthernetIP.ImplicitOutputs.OutputValue31	See output 1 value for details	int16	7fa8	32680	Not applicable
EthernetIP.ImplicitOutputs.OutputValue32	See output 1 value for details	int16	7fac	32684	Not applicable
EthernetIP.ImplicitOutputs.OutputValue33	See output 1 value for details	int16	7fb0	32688	Not applicable
EthernetIP.ImplicitOutputs.OutputValue34	See output 1 value for details	int16	7fb4	32692	Not applicable
EthernetIP.ImplicitOutputs.OutputValue35	See output 1 value for details	int16	7fb8	32696	Not applicable
EthernetIP.ImplicitOutputs.OutputValue36	See output 1 value for details	int16	7fbc	32700	Not applicable
EthernetIP.ImplicitOutputs.OutputValue37	See output 1 value for details	int16	7fc0	32704	Not applicable
EthernetIP.ImplicitOutputs.OutputValue38	See output 1 value for details	int16	7fc4	32708	Not applicable
EthernetIP.ImplicitOutputs.OutputValue39	See output 1 value for details	int16	7fc8	32712	Not applicable
EthernetIP.ImplicitOutputs.OutputValue40	See output 1 value for details	int16	7fcc	32716	Not applicable
EthernetIP.ImplicitOutputs.OutputValue41	See output 1 value for details	int16	7fd0	32720	Not applicable
EthernetIP.ImplicitOutputs.OutputValue42	See output 1 value for details	int16	7fd4	32724	Not applicable
EthernetIP.ImplicitOutputs.OutputValue43	See output 1 value for details	int16	7fd8	32728	Not applicable
EthernetIP.ImplicitOutputs.OutputValue44	See output 1 value for details	int16	7fdc	32732	Not applicable
EthernetIP.ImplicitOutputs.OutputValue45	See output 1 value for details	int16	7fe0	32736	Not applicable
EthernetIP.ImplicitOutputs.OutputValue46	See output 1 value for details	int16	7fe4	32740	Not applicable

Parameter path	Description	Type	Hex	Dec	Resolution
EthernetIP.ImplicitOutputs.OutputValue48	See output 1 value for details	int16	7fec	32748	Not applicable
EthernetIP.ImplicitOutputs.OutputValue49	See output 1 value for details	int16	7ff0	32752	Not applicable
EthernetIP.ImplicitOutputs.OutputValue50	See output 1 value for details	int16	7ff4	32756	Not applicable
EthernetIP.InputTags.Input1	A read only input from a PLC device	string_t	7838	30776	Not applicable
EthernetIP.InputTags.Input2	See input 1 for details	string_t	7839	30777	Not applicable
EthernetIP.InputTags.Input3	See input 1 for details	string_t	783a	30778	Not applicable
EthernetIP.InputTags.Input4	See input 1 for details	string_t	783b	30779	Not applicable
EthernetIP.InputTags.Input5	See input 1 for details	string_t	783c	30780	Not applicable
EthernetIP.InputTags.Input6	See input 1 for details	string_t	783d	30781	Not applicable
EthernetIP.InputTags.Input7	See input 1 for details	string_t	783e	30782	Not applicable
EthernetIP.InputTags.Input8	See input 1 for details	string_t	783f	30783	Not applicable
EthernetIP.InputTags.Input9	See input 1 for details	string_t	7840	30784	Not applicable
EthernetIP.InputTags.Input10	See input 1 for details	string_t	7841	30785	Not applicable
EthernetIP.InputTags.Input11	See input 1 for details	string_t	7842	30786	Not applicable
EthernetIP.InputTags.Input12	See input 1 for details	string_t	7843	30787	Not applicable
EthernetIP.InputTags.Input13	See input 1 for details	string_t	7844	30788	Not applicable
EthernetIP.InputTags.Input14	See input 1 for details	string_t	7845	30789	Not applicable
EthernetIP.InputTags.Input15	See input 1 for details	string_t	7846	30790	Not applicable
EthernetIP.InputTags.Input16	See input 1 for details	string_t	7847	30791	Not applicable
EthernetIP.InputTags.Input17	See input 1 for details	string_t	7848	30792	Not applicable
EthernetIP.InputTags.Input18	See input 1 for details	string_t	7849	30793	Not applicable
EthernetIP.InputTags.Input19	See input 1 for details	string_t	784a	30794	Not applicable
EthernetIP.InputTags.Input20	See input 1 for details	string_t	784b	30795	Not applicable
EthernetIP.InputTags.Input21	See input 1 for details	string_t	784c	30796	Not applicable
EthernetIP.InputTags.Input22	See input 1 for details	string_t	784d	30797	Not applicable
EthernetIP.InputTags.Input23	See input 1 for details	string_t	784e	30798	Not applicable
EthernetIP.InputTags.Input24	See input 1 for details	string_t	784f	30799	Not applicable
EthernetIP.InputTags.Input25	See input 1 for details	string_t	7850	30800	Not applicable
EthernetIP.InputTags.Input26	See input 1 for details	string_t	7851	30801	Not applicable
EthernetIP.InputTags.Input27	See input 1 for details	string_t	7852	30802	Not applicable
EthernetIP.InputTags.Input28	See input 1 for details	string_t	7853	30803	Not applicable
EthernetIP.InputTags.Input29	See input 1 for details	string_t	7854	30804	Not applicable
EthernetIP.InputTags.Input30	See input 1 for details	string_t	7855	30805	Not applicable
EthernetIP.Main.ConfigInstance	Configuration assembly instance number	int16	7ffa	32762	Not applicable
EthernetIP.Main.ConfigSize	Configuration assembly data size in bytes	int16	7ffb	32763	Not applicable
EthernetIP.Main.ConnectionType	Implicit I/O connection type (0 = Point to point; 1 = Multicast)	uint8	7ffe	32766	Not applicable
EthernetIP.Main.Explicit1	Explicit TCP connection 1	string_t	65f1	26097	Not applicable
EthernetIP.Main.Explicit2	Explicit TCP connection 2	string_t	6601	26113	Not applicable
EthernetIP.Main.ImplicitIO	Implicit I/O data channel	string_t	65e1	26081	Not applicable
EthernetIP.Main.InputInstance	Implicit input assembly instance number	int16	7ff6	32758	Not applicable
EthernetIP.Main.InputSize	Implicit input assembly data size in bytes	int16	7ff7	32759	Not applicable
EthernetIP.Main.Mode	EtherNet/IP operation mode 0 = Server 1 = Client (IO) 2 = Client (Tags)	uint8	7fff	32767	Not applicable
EthernetIP.Main.Multicast	Implicit I/O data channel multicast address	string_t	6611	26129	Not applicable
EthernetIP.Main.NetworkStatusCode	EtherNet/IP communications network status 0 = Offline 2 = On line 3 = Connection timeout 4 = Duplicate IP address 5 = Initialisation	uint8	7e64	32356	Not applicable
EthernetIP.Main.OutputInstance	Implicit output assembly instance number	int16	7ff8	32760	Not applicable
EthernetIP.Main.OutputSize	Implicit output assembly data size in bytes	int16	7ff9	32761	Not applicable
EthernetIP.Main.Priority	Level of message priority 0 = Low 1 = High 2 = Scheduled 3 = Urgent	uint8	7ffc	32764	Not applicable
EthernetIP.Main.ResetComms	Resets the client or server communications (0 = No; 1 = Yes)	uint8	7e63	32355	Not applicable
EthernetIP.Main.Rpi	Requested Packet Interval (milliseconds)	int16	7ffd	32765	Not applicable
EthernetIP.Main.ServerAddress	IP address of a server device	string_t	7129	28969	Not applicable
EthernetIP.Main.SlotNumber	PLC slot number	int16	7e60	32352	Not applicable
EthernetIP.Main.TagStatusCode	EtherNet/IP Tag server status code (see Figure 129)	uint8	7e62	32354	Not applicable
EthernetIP.Main.UCMM	Unconnected Message Manager (UCMM)	string_t	65d1	26065	Not applicable
EthernetIP.OutputTags.Output1	Writable output to the PLC device	string_t	7880	30848	Not applicable

Parameter path	Description	Type	Hex	Dec	Resolution
EthernetIP.OutputTags.Output3	See output 1 for details	string_t	7882	30850	Not applicable
EthernetIP.OutputTags.Output4	See output 1 for details	string_t	7883	30851	Not applicable
EthernetIP.OutputTags.Output5	See output 1 for details	string_t	7884	30852	Not applicable
EthernetIP.OutputTags.Output6	See output 1 for details	string_t	7885	30853	Not applicable
EthernetIP.OutputTags.Output7	See output 1 for details	string_t	7886	30854	Not applicable
EthernetIP.OutputTags.Output8	See output 1 for details	string_t	7887	30855	Not applicable
EthernetIP.OutputTags.Output9	See output 1 for details	string_t	7888	30856	Not applicable
EthernetIP.OutputTags.Output10	See output 1 for details	string_t	7889	30857	Not applicable
EthernetIP.OutputTags.Output11	See output 1 for details	string_t	788a	30858	Not applicable
EthernetIP.OutputTags.Output12	See output 1 for details	string_t	788b	30859	Not applicable
EthernetIP.OutputTags.Output13	See output 1 for details	string_t	788c	30860	Not applicable
EthernetIP.OutputTags.Output14	See output 1 for details	string_t	788d	30861	Not applicable
EthernetIP.OutputTags.Output15	See output 1 for details	string_t	788e	30862	Not applicable
EthernetIP.OutputTags.Output16	See output 1 for details	string_t	788f	30863	Not applicable
EthernetIP.OutputTags.Output17	See output 1 for details	string_t	7890	30864	Not applicable
EthernetIP.OutputTags.Output18	See output 1 for details	string_t	7891	30865	Not applicable
EthernetIP.OutputTags.Output19	See output 1 for details	string_t	7892	30866	Not applicable
EthernetIP.OutputTags.Output20	See output 1 for details	string_t	7893	30867	Not applicable
EthernetIP.OutputTags.Output21	See output 1 for details	string_t	7894	30868	Not applicable
EthernetIP.OutputTags.Output22	See output 1 for details	string_t	7895	30869	Not applicable
EthernetIP.OutputTags.Output23	See output 1 for details	string_t	7896	30870	Not applicable
EthernetIP.OutputTags.Output24	See output 1 for details	string_t	7897	30871	Not applicable
EthernetIP.OutputTags.Output25	See output 1 for details	string_t	7898	30872	Not applicable
EthernetIP.OutputTags.Output26	See output 1 for details	string_t	7899	30873	Not applicable
EthernetIP.OutputTags.Output27	See output 1 for details	string_t	789a	30874	Not applicable
EthernetIP.OutputTags.Output28	See output 1 for details	string_t	789b	30875	Not applicable
EthernetIP.OutputTags.Output29	See output 1 for details	string_t	789c	30876	Not applicable
EthernetIP.OutputTags.Output30	See output 1 for details	string_t	789d	30877	Not applicable
Group.Recording.Channel1En	Channel 1 enable (0 = Disabled; 1 = Enabled)	bool	1023	4131	Not applicable
Group.Recording.Channel2En	Channel 2 enable (0 = Disabled; 1 = Enabled)	bool	1024	4132	Not applicable
Group.Recording.Channel3En	Channel 3 enable (0 = Disabled; 1 = Enabled)	bool	1025	4133	Not applicable
Group.Recording.Channel4En	Channel 4 enable (0 = Disabled; 1 = Enabled)	bool	1026	4134	Not applicable
Group.Recording.Compression	The UHH file compression rate (0 = Normal; 1 = High)	uint8	1040	4160	Not applicable
Group.Recording.Enable	0 = Recording disabled; 1 = Recording enabled	uint8	1020	4128	Not applicable
Group.Recording.FlashDuration	Time in days until flash history files begin to be overwritten	float32	1039	4153	2dp
Group.Recording.FlashFree	Size of the internal flash in MBytes	float32	1038	4152	2dp
Group.Recording.FlashSize	Size of the internal flash in MBytes	float32	1037	4151	2dp
Group.Recording.Interval	Recording interval 0 = 0.125 secs 1 = 0.25 secs 2 = 0.5 secs 3 = 1Hz 4 = 2 sec 5 = 5 sec 6 = 10 sec 7 = 20 sec 8 = 30 sec 9 = 1 min 10 = 2 min 11 = 5 min 12 = 10 min 13 = 20 min 14 = 30 min 15 = 1 hr	int32	1022	4130	Not applicable
Group.Recording.Status	Recording status 0 = Not recording 1 = Disabled 2 = Messages only 3 = Recording enabled 4 = Recording paused	int16	1036	4150	Not applicable
Group.Recording.Suspend	1 = Suspend recording	bool	1035	4149	Not applicable
Group.Recording.VirtualChan1En	Virtual Channel 1 enable (0 = Disabled; 1 = Enabled)	bool	1027	4135	Not applicable
Group.Recording.VirtualChan2En	Virtual Channel 2 enable (0 = Disabled; 1 = Enabled)	bool	1028	4136	Not applicable
Group.Recording.VirtualChan3En	Virtual Channel 3 enable (0 = Disabled; 1 = Enabled)	bool	1029	4137	Not applicable
Group.Recording.VirtualChan4En	Virtual Channel 4 enable (0 = Disabled; 1 = Enabled)	bool	102a	4138	Not applicable
Group.Recording.VirtualChan5En	Virtual Channel 5 enable (0 = Disabled; 1 = Enabled)	bool	102b	4139	Not applicable
Group.Recording.VirtualChan6En	Virtual Channel 6 enable (0 = Disabled; 1 = Enabled)	bool	102c	4140	Not applicable
Group.Recording.VirtualChan7En	Virtual Channel 7 enable (0 = Disabled; 1 = Enabled)	bool	102d	4141	Not applicable
Group.Recording.VirtualChan8En	Virtual Channel 8 enable (0 = Disabled; 1 = Enabled)	bool	102e	4142	Not applicable
Group.Recording.VirtualChan9En	Virtual Channel 9 enable (0 = Disabled; 1 = Enabled)	bool	102f	4143	Not applicable
Group.Recording.VirtualChan10En	Virtual Channel 10 enable (0 = Disabled; 1 = Enabled)	bool	1030	4144	Not applicable
Group.Recording.VirtualChan11En	Virtual Channel 11 enable (0 = Disabled; 1 = Enabled)	bool	1031	4145	Not applicable
Group.Recording.VirtualChan12En	Virtual Channel 12 enable (0 = Disabled; 1 = Enabled)	bool	1032	4146	Not applicable
Group.Recording.VirtualChan13En	Virtual Channel 13 enable (0 = Disabled; 1 = Enabled)	bool	1033	4147	Not applicable

Parameter path	Description	Type	Hex	Dec	Resolution
Group.Recording.VirtualChan15En	Virtual Channel 15 enable (0 = Disabled; 1 = Enabled)	bool	103a	4154	Not applicable
Group.Recording.VirtualChan16En	Virtual Channel 16 enable (0 = Disabled; 1 = Enabled)	bool	103b	4155	Not applicable
Group.Recording.VirtualChan17En	Virtual Channel 17 enable (0 = Disabled; 1 = Enabled)	bool	103c	4156	Not applicable
Group.Recording.VirtualChan18En	Virtual Channel 18 enable (0 = Disabled; 1 = Enabled)	bool	103d	4157	Not applicable
Group.Recording.VirtualChan19En	Virtual Channel 19 enable (0 = Disabled; 1 = Enabled)	bool	103e	4158	Not applicable
Group.Recording.VirtualChan20En	Virtual Channel 20 enable (0 = Disabled; 1 = Enabled)	bool	103f	4159	Not applicable
Group.Recording.VirtualChan21En	Virtual Channel 21 enable (0 = Disabled; 1 = Enabled)	bool	1041	4161	Not applicable
Group.Recording.VirtualChan22En	Virtual Channel 22 enable (0 = Disabled; 1 = Enabled)	bool	1042	4162	Not applicable
Group.Recording.VirtualChan23En	Virtual Channel 23 enable (0 = Disabled; 1 = Enabled)	bool	1043	4163	Not applicable
Group.Recording.VirtualChan24En	Virtual Channel 24 enable (0 = Disabled; 1 = Enabled)	bool	1044	4164	Not applicable
Group.Recording.VirtualChan25En	Virtual Channel 25 enable (0 = Disabled; 1 = Enabled)	bool	1045	4165	Not applicable
Group.Recording.VirtualChan26En	Virtual Channel 26 enable (0 = Disabled; 1 = Enabled)	bool	1046	4166	Not applicable
Group.Recording.VirtualChan27En	Virtual Channel 27 enable (0 = Disabled; 1 = Enabled)	bool	1047	4167	Not applicable
Group.Recording.VirtualChan28En	Virtual Channel 28 enable (0 = Disabled; 1 = Enabled)	bool	1048	4168	Not applicable
Group.Recording.VirtualChan29En	Virtual Channel 29 enable (0 = Disabled; 1 = Enabled)	bool	1049	4169	Not applicable
Group.Recording.VirtualChan30En	Virtual Channel 30 enable (0 = Disabled; 1 = Enabled)	bool	104a	4170	Not applicable
Group.Trend.Descriptor	Group descriptor	string_t	5b00	23296	Not applicable
Group.Trend.Interval	Trend interval. As Group.Recording.Interval, above	int32	1002	4098	Not applicable
Group.Trend.MajorDivisions	Number of major divisions	uint8	1004	4100	Not applicable
Group.Trend.Point1	1st point in the group (VCh = Virtual channel) 0 = No trend 1 = Channel 1 2 = Channel 2 3 = Channel 3 4 = Channel 4 5 = VCh1 6 = VCh2 7 = VCh3 8 = VCh4 9 = VCh5 10 = VCh6 11 = VCh7 12 = VCh8 13 = VCh9 14 = VCh10 15 = VCh11 16 = VCh12 17 = VCh13 18 = VCh14 19 = VCh15 20 = VCh 16 21 = VCh17 22 = VCh18 23 = VCh 19 24 = VCh20 25 = VCh21 26 = VCh 22 27 = VCh23 28 = VCh24 29 = VCh 25 30 = VCh26 31 = VCh27 32 = VCh 28 33 = VCh29 34 = VCh30	uint8	1006	4102	Not applicable
Group.Trend.Point2	As Group.Trend.Point1 but for 2nd point in group	uint8	1007	4103	Not applicable
Group.Trend.Point3	As Group.Trend.Point1 but for 3rd point in group	uint8	1008	4104	Not applicable
Group.Trend.Point4	As Group.Trend.Point1 but for 4th point in group	uint8	1009	4105	Not applicable
Group.Trend.Point5	As Group.Trend.Point1 but for 5th point in group	uint8	100a	4106	Not applicable
Group.Trend.Point6	As Group.Trend.Point1 but for 6th point in group	uint8	100b	4107	Not applicable
Humidity.DewPoint	Dewpoint	float32	2e79	11897	Set by Humidity.Resolution
Humidity.DryTemp	Dry Bulb Temperature Measurement	float32	2e7d	11901	0dp
Humidity.Pressure	Current Atmospheric Pressure	float32	2e80	11904	1dp
Humidity.PsychroConst	Psychrometric Constant	float32	2e7f	11903	2dp
Humidity.RelHumid	Calculated Relative Humidity	float32	2e78	11896	Set by Humidity.Resolution
Humidity.Resolution	Result Resolution	uint8	2e81	11905	Not applicable
Humidity.SBrk	Sensor Broken (0 = No; 1 = Yes)	bool	2e7e	11902	Not applicable
Humidity.WetOffset	Offset of the Wet Bulb Temperature	float32	2e7b	11899	Same as Humidity.WetTemp
Humidity.WetTemp	Wet Bulb Temperature Measurement	float32	2e7c	11900	0dp
Instrument.Clock.Date	Local Date	string_t	4400	17408	Not applicable
Instrument.Clock.DST	1 = DST active; 0 = DST not active	bool	1082	4226	Not applicable
Instrument.Clock.Time	Local time (including Zone and DST effects)	time_t	1081	4225	Set by Network.Modbus.TimeFormat
Instrument.Display.AlarmPanel	1 = Alarm Panel display mode enabled	bool	10eb	4331	Not applicable
Instrument.Display.Brightness	Display brightness 10 = 10%; 20 = 20% etc. (whole decades)	uint8	1090	4240	Not applicable
Instrument.Display.Cascade	1 = Cascade control display mode enabled	bool	10f2	4338	Not applicable
Instrument.Display.DualLoopControl	1 = Dual loop control display mode enabled	bool	109b	4251	Not applicable
Instrument.Display.EIPServerPage	1 = EtherNet/IPdisplay mode enabled	bool	10ef	4335	Not applicable
Instrument.Display.FaceplateCycling	1 = Faceplate cycling On	bool	109e	4254	Not applicable
Instrument.Display.FutureTrend	1 = Future trend display mode enabled	bool	10fb	4347	Not applicable
Instrument.Display.FutureTrend1Colour	Future trend colour(1) (As Channel.1.Trend.Colour)	uint8	10fc	4348	Not applicable
Instrument.Display.FutureTrend2Colour	Future trend colour(2) (As Channel.1.Trend.Colour)	uint8	10fd	4349	Not applicable
Instrument.Display.HistoryBackground	History background colour 0 = Black; 1 = Dark grey; 2 = Light grey; 3 = White	uint8	10a8	4264	Not applicable
Instrument.Display.HomePage	Home page	uint8	1093	4243	Not applicable
Instrument.Display.HorizontalBar	1 = Horizontal bar mode enabled	bool	1098	4248	Not applicable
Instrument.Display.HorizontalTrend	1 = Horizontal trend mode enabled	bool	109e	4248	Not applicable

Parameter path	Description	Type	Hex	Dec	Resolution
Instrument.Display.HTrendScaling	0 = hide horizontal trend scale; 1 = scale permanent	uint8	109d	4253	Not applicable
Instrument.Display.LoopControl	1 = Loop control display mode enabled	bool	109a	4250	Not applicable
Instrument.Display.LoopSetpointColour	Loop setpoint colour (As Channel.1.Trend.Colour)	uint8	109f	4255	Not applicable
Instrument.Display.ModbusMaster	1 = Modbus Master display mode enabled	bool	10ee	4334	Not applicable
Instrument.Display.NumberFormat	Number format (0 = Rounded; 1 - Truncated)	uint8	10fe	4350	Not applicable
Instrument.Display.Numeric	1 = Numeric display mode enabled	bool	1099	4249	Not applicable
Instrument.Display.Programmer	1 = Programmer interface display mode enabled	bool	10f3	4339	Not applicable
Instrument.Display.PromoteListView	1 = Promote list display mode enabled	bool	10ea	4330	Not applicable
Instrument.Display.ScreenSaverAfter	Screen save after (in minutes)	int16	1091	4241	Not applicable
Instrument.Display.ScreenSaverBrightness	Screen saver brightness 10 = 10%; 20 = 20% etc. (whole decades only)	uint8	1092	4242	Not applicable
Instrument.Display.SteriliserPage	1 = Steriliser display mode enabled	bool	10ec	4332	Not applicable
Instrument.Display.TrendBackground	Trend chart colour: 0 = Black; 1 = Dark Grey; 2 = Light grey; 3 = White.	uint8	109c	4252	Not applicable
Instrument.Display.VerticalBar	1 = Vertical bar display mode enabled	bool	1097	4247	Not applicable
Instrument.Display.VerticalTrend	1 = Vertical trend display mode enabled	bool	1095	4245	Not applicable
Instrument.Info.Bootrom	Instrument bootrom version	string_t	447a	17530	Not applicable
Instrument.Info.CompanyID	Company identification. Always returns 1280	int16	0079	121	Not applicable
Instrument.Info.ConfigRev	The instrument configuration revision number	int32	10a0	4256	Not applicable
Instrument.Info.IM	Instrument mode Operating: All algorithms and I/O active. Standby: Control o/p off. Absolute alarms active Engineer: All outputs inactive.	uint8	00c7	199	Not applicable
Instrument.Info.LineVoltage	Displays the current line voltage	float32	10a6	4262	1dp
Instrument.Info.MicroBoardIssue	Micro Board Issue	uint8	10aa	4266	Not applicable
Instrument.Info.Name	The instrument descriptor	string_t	445f	17503	Not applicable
Instrument.Info.NVolWrites	Displays the number of non-volatile writes performed	int32	10a5	4261	Not applicable
Instrument.Info.PSUType	PSU type. 0 = 240Vac; 1 = 24v ac/dc	uint8	10a9	4265	Not applicable
Instrument.Info.SecurityRev	The instrument security revision number	int32	10a4	4260	Not applicable
Instrument.Info.Type	Instrument type	uint8	10a2	4258	Not applicable
Instrument.Info.Version	Instrument version	string_t	4474	17524	Not applicable
Instrument.Info.WiresFree	Number of wires free	int16	10ab	4267	Not applicable
Instrument.IOFitted.1A1B	I/O fitted at terminals 1A1B 0 = Digital IO 1 = Non-isolated dc op (mA only) 2 = Relay OP 3 = TRIAC 1a1b 4 = Relay OP 5 = Isolated dc op (V/mA) 6 = Digital ip 7 = Isolated dc output (mA only) 8 = Digital op 9 = Relay op 10 = Triac 2A2B	uint8	10f4	4340	Not applicable
Instrument.IOFitted.2A2B	I/O fitted at terminals 2A2B (as for 1A1B above)	uint8	10f5	4341	Not applicable
Instrument.IOFitted.3A3B	I/O type fitted at terminals 3A3B (as for 1A1B above)	uint8	10f7	4343	Not applicable
Instrument.IOFitted.4AC	I/O type fitted at terminals 4AC (as for 1A1B above)	uint8	10f9	4345	Not applicable
Instrument.IOFitted.5AC	I/O type fitted at terminals 5AC (as for 1A1B above)	uint8	10fa	4346	Not applicable
Instrument.IOFitted.LALC	I/O type fitted at terminals LALC (as for 1A1B above)	uint8	10f6	4342	Not applicable
Instrument.IOFitted.LBLC	I/O type fitted at terminals LBLC (as for 1A1B above)	uint8	10f8	4344	Not applicable
Instrument.Locale.DateFormat	Date format (0 = DDMYY. 1 = MMDDYY; 2 = YYMMDD)	uint8	10b1	4273	Not applicable
Instrument.Locale.DSTenable	1 = Daylight Saving Time enabled	bool	10b3	4275	Not applicable
Instrument.Locale.EndDay	Daylight savings: End day 0 = Sunday 1 = Monday 2 = Tuesday 3 = Wednesday 4 = Thursday 5 = Friday 6 = Saturday	uint8	10ba	4282	Not applicable
Instrument.Locale.EndMonth	Daylight savings: End month 0 = January 1 = February 2 = March 3 = April 4 = May 5 = June 6 = July 7 = August 8 = September 9 = October 10 = November 11 = December	uint8	10bb	4283	Not applicable
Instrument.Locale.EndOn	Week for changing to/from DST 0 = First 1 = Second 2 = Third 3 = Fourth 4 = Last 5 = Second to last	uint8	10b9	4281	Not applicable
Instrument.Locale.EndTime	DST end time in hours, minutes, seconds and milliseconds	time_t	10b8	4280	Set by Network.Modbus.TimeFormat
Instrument.Locale.Language	Language (0 = English)	uint8	10b0	4272	Not applicable
Instrument.Locale.StartDay	DST start day. As Instrument.Locale.EndDay, above	uint8	10b6	4278	Not applicable
Instrument.Locale.StartMonth	DST start month As Instrument.Locale.EndMonth, above	uint8	10b7	4279	Not applicable
Instrument.Locale.StartOn	Start DST on. As Instrument.Locale.EndOn, above	uint8	10b5	4277	Not applicable
Instrument.Locale.StartTime	DST start time. As Instrument.Locale.EndTime above	time_t	10b4	4276	Set by Network.Modbus.TimeFormat

Parameter path	Description	Type	Hex	Dec	Resolution
	0 = GMT - 12 hours 2 = GMT - 10 hours 4 = GMT - 8 hours 6 = GMT - 6 hours 8 = GMT - 4 hours 10 = GMT - 3 hours 12 = GMT - 1 hour 14 = GMT + 1 hour 16 = GMT + 3 hours 18 = GMT + 4 hours 20 = GMT + 5 hours 22 = GMT + 5.75 hours 24 = GMT + 6.5 hours 26 = GMT + 8 hours 28 = GMT + 9.5 hours 30 = GMT + 11 hours 32 = GMT + 13 hours 1 = GMT - 11 hours 3 = GMT - 9 hours 5 = GMT - 7 hours 7 = GMT - 5 hours 9 = GMT - 3.5 hours 11 = GMT - 2 hours 13 = GMT 15 = GMT + 2 hours 17 = GMT + 3.5 hours 19 = GMT + 4.5 hours 21 = GMT + 5.5 hours 23 = GMT + 6 hours 25 = GMT + 7 hours 27 = GMT + 9 hours 29 = GMT + 10 hours 31 = GMT + 12 hours				
Instrument.Notes.Note	Operator Note	string_t	5500	21760	Not applicable
Instrument.Notes.Note1	Operator note 1	string_t	5580	21888	Not applicable
Instrument.Notes.Note2	Operator note 2	string_t	5600	22016	Not applicable
Instrument.Notes.Note3	Operator note 3	string_t	5680	22144	Not applicable
Instrument.Notes.Note4	Operator note 4	string_t	5700	22272	Not applicable
Instrument.Notes.Note5	Operator note 5	string_t	5780	22400	Not applicable
Instrument.Notes.Note6	Operator note 6	string_t	5800	22528	Not applicable
Instrument.Notes.Note7	Operator note 7	string_t	5880	22656	Not applicable
Instrument.Notes.Note8	Operator note 8	string_t	5900	22784	Not applicable
Instrument.Notes.Note9	Operator note 9	string_t	5980	22912	Not applicable
Instrument.Notes.Note10	Operator note 10	string_t	5a00	23040	Not applicable
Instrument.PromoteList.PromoteListName	Promote list (operator view) title	string_t	6d07	27911	Not applicable
Instrument.PromoteList.PromoteParam1	Promote parameter (1)	eint32	10e0	4320	Not applicable
Instrument.PromoteList.PromoteParam1Desc	Descriptor for promote parameter (1)	string_t	6300	25344	Not applicable
Instrument.PromoteList.PromoteParam2	Promote parameter (2)	eint32	10e1	4321	Not applicable
Instrument.PromoteList.PromoteParam2Desc	Descriptor for promote parameter (2)	string_t	6315	25365	Not applicable
Instrument.PromoteList.PromoteParam3	Promote parameter (3)	eint32	10e2	4322	Not applicable
Instrument.PromoteList.PromoteParam3Desc	Descriptor for promote parameter (3)	string_t	632a	25386	Not applicable
Instrument.PromoteList.PromoteParam4	Promote parameter (4)	eint32	10e3	4323	Not applicable
Instrument.PromoteList.PromoteParam4Desc	Descriptor for promote parameter (4)	string_t	633f	25407	Not applicable
Instrument.PromoteList.PromoteParam5	Promote parameter (5)	eint32	10e4	4324	Not applicable
Instrument.PromoteList.PromoteParam5Desc	Descriptor for promote parameter (5)	string_t	6354	25428	Not applicable
Instrument.PromoteList.PromoteParam6	Promote parameter (6)	eint32	10e5	4325	Not applicable
Instrument.PromoteList.PromoteParam6Desc	Descriptor for promote parameter (6)	string_t	6369	25449	Not applicable
Instrument.PromoteList.PromoteParam7	Promote parameter (7)	eint32	10e6	4326	Not applicable
Instrument.PromoteList.PromoteParam7Desc	Descriptor for promote parameter (7)	string_t	637e	25470	Not applicable
Instrument.PromoteList.PromoteParam8	Promote parameter (8)	eint32	10e7	4327	Not applicable
Instrument.PromoteList.PromoteParam8Desc	Descriptor for promote parameter (8)	string_t	6393	25491	Not applicable
Instrument.PromoteList.PromoteParam9	Promote parameter (9)	eint32	10e8	4328	Not applicable
Instrument.PromoteList.PromoteParam9Desc	Descriptor for promote parameter (9)	string_t	63a8	25512	Not applicable
Instrument.PromoteList.PromoteParam10	Promote parameter (10)	eint32	10e9	4329	Not applicable
Instrument.PromoteList.PromoteParam10Desc	Descriptor for promote parameter (10)	string_t	63bd	25533	Not applicable
Instrument.OEMConfigList.Parameter1	Parameter that is to be alterable	eint32	1230	4656	Not applicable
Instrument.OEMConfigList.Parameter2	Parameter that is to be alterable	eint32	1231	4657	Not applicable
Instrument.OEMConfigList.Parameter3	Parameter that is to be alterable	eint32	1232	4658	Not applicable
Instrument.OEMConfigList.Parameter4	Parameter that is to be alterable	eint32	1233	4659	Not applicable
Instrument.OEMConfigList.Parameter5	Parameter that is to be alterable	eint32	1234	4660	Not applicable
Instrument.OEMConfigList.Parameter6	Parameter that is to be alterable	eint32	1235	4661	Not applicable
Instrument.OEMConfigList.Parameter7	Parameter that is to be alterable	eint32	1236	4662	Not applicable
Instrument.OEMConfigList.Parameter8	Parameter that is to be alterable	eint32	1237	4663	Not applicable
Instrument.OEMConfigList.Parameter9	Parameter that is to be alterable	eint32	1238	4664	Not applicable
Instrument.OEMConfigList.Parameter10	Parameter that is to be alterable	eint32	1239	4665	Not applicable
Instrument.OEMConfigList.Parameter11	Parameter that is to be alterable	eint32	123a	4666	Not applicable
Instrument.OEMConfigList.Parameter12	Parameter that is to be alterable	eint32	123b	4667	Not applicable
Instrument.OEMConfigList.Parameter13	Parameter that is to be alterable	eint32	123c	4668	Not applicable
Instrument.OEMConfigList.Parameter14	Parameter that is to be alterable	eint32	123d	4669	Not applicable
Instrument.OEMConfigList.Parameter15	Parameter that is to be alterable	eint32	123e	4670	Not applicable
Instrument.OEMConfigList.Parameter16	Parameter that is to be alterable	eint32	123f	4671	Not applicable
Instrument.OEMConfigList.Parameter17	Parameter that is to be alterable	eint32	1240	4672	Not applicable
Instrument.OEMConfigList.Parameter18	Parameter that is to be alterable	eint32	1241	4673	Not applicable
Instrument.OEMConfigList.Parameter19	Parameter that is to be alterable	eint32	1242	4674	Not applicable
Instrument.OEMConfigList.Parameter20	Parameter that is to be alterable	eint32	1243	4675	Not applicable

Parameter path	Description	Type	Hex	Dec	Resolution
Instrument.OEMSupervisorList.Parameter45	Parameter that is to be read only	eint32	12c0	4800	Not applicable
Instrument.OEMSupervisorList.Parameter46	Parameter that is to be read only	eint32	12c1	4801	Not applicable
Instrument.OEMSupervisorList.Parameter47	Parameter that is to be read only	eint32	12c2	4802	Not applicable
Instrument.OEMSupervisorList.Parameter48	Parameter that is to be read only	eint32	12c3	4803	Not applicable
Instrument.OEMSupervisorList.Parameter49	Parameter that is to be read only	eint32	12c4	4804	Not applicable
Instrument.OEMSupervisorList.Parameter50	Parameter that is to be read only	eint32	12c5	4805	Not applicable
Instrument.OEMSupervisorList.Parameter51	Parameter that is to be read only	eint32	12c6	4806	Not applicable
Instrument.OEMSupervisorList.Parameter52	Parameter that is to be read only	eint32	12c7	4807	Not applicable
Instrument.OEMSupervisorList.Parameter53	Parameter that is to be read only	eint32	12c8	4808	Not applicable
Instrument.OEMSupervisorList.Parameter54	Parameter that is to be read only	eint32	12c9	4809	Not applicable
Instrument.OEMSupervisorList.Parameter55	Parameter that is to be read only	eint32	12ca	4810	Not applicable
Instrument.OEMSupervisorList.Parameter56	Parameter that is to be read only	eint32	12cb	4811	Not applicable
Instrument.OEMSupervisorList.Parameter57	Parameter that is to be read only	eint32	12cc	4812	Not applicable
Instrument.OEMSupervisorList.Parameter58	Parameter that is to be read only	eint32	12cd	4813	Not applicable
Instrument.OEMSupervisorList.Parameter59	Parameter that is to be read only	eint32	12ce	4814	Not applicable
Instrument.OEMSupervisorList.Parameter60	Parameter that is to be read only	eint32	12cf	4815	Not applicable
Instrument.OEMSupervisorList.Parameter61	Parameter that is to be read only	eint32	12d0	4816	Not applicable
Instrument.OEMSupervisorList.Parameter62	Parameter that is to be read only	eint32	12d1	4817	Not applicable
Instrument.OEMSupervisorList.Parameter63	Parameter that is to be read only	eint32	12d2	4818	Not applicable
Instrument.OEMSupervisorList.Parameter64	Parameter that is to be read only	eint32	12d3	4819	Not applicable
Instrument.OEMSupervisorList.Parameter65	Parameter that is to be read only	eint32	12d4	4820	Not applicable
Instrument.OEMSupervisorList.Parameter66	Parameter that is to be read only	eint32	12d5	4821	Not applicable
Instrument.OEMSupervisorList.Parameter67	Parameter that is to be read only	eint32	12d6	4822	Not applicable
Instrument.OEMSupervisorList.Parameter68	Parameter that is to be read only	eint32	12d7	4823	Not applicable
Instrument.OEMSupervisorList.Parameter69	Parameter that is to be read only	eint32	12d8	4824	Not applicable
Instrument.OEMSupervisorList.Parameter70	Parameter that is to be read only	eint32	12d9	4825	Not applicable
Instrument.OEMSupervisorList.Parameter71	Parameter that is to be read only	eint32	12da	4826	Not applicable
Instrument.OEMSupervisorList.Parameter72	Parameter that is to be read only	eint32	12db	4827	Not applicable
Instrument.OEMSupervisorList.Parameter73	Parameter that is to be read only	eint32	12dc	4828	Not applicable
Instrument.OEMSupervisorList.Parameter74	Parameter that is to be read only	eint32	12dd	4829	Not applicable
Instrument.OEMSupervisorList.Parameter75	Parameter that is to be read only	eint32	12de	4830	Not applicable
Instrument.OEMSupervisorList.Parameter76	Parameter that is to be read only	eint32	12df	4831	Not applicable
Instrument.OEMSupervisorList.Parameter77	Parameter that is to be read only	eint32	12e0	4832	Not applicable
Instrument.OEMSupervisorList.Parameter78	Parameter that is to be read only	eint32	12e1	4833	Not applicable
Instrument.OEMSupervisorList.Parameter79	Parameter that is to be read only	eint32	12e2	4834	Not applicable
Instrument.OEMSupervisorList.Parameter80	Parameter that is to be read only	eint32	12e3	4835	Not applicable
Instrument.OEMSupervisorList.Parameter81	Parameter that is to be read only	eint32	12e4	4836	Not applicable
Instrument.OEMSupervisorList.Parameter82	Parameter that is to be read only	eint32	12e5	4837	Not applicable
Instrument.OEMSupervisorList.Parameter83	Parameter that is to be read only	eint32	12e6	4838	Not applicable
Instrument.OEMSupervisorList.Parameter84	Parameter that is to be read only	eint32	12e7	4839	Not applicable
Instrument.OEMSupervisorList.Parameter85	Parameter that is to be read only	eint32	12e8	4840	Not applicable
Instrument.OEMSupervisorList.Parameter86	Parameter that is to be read only	eint32	12e9	4841	Not applicable
Instrument.OEMSupervisorList.Parameter87	Parameter that is to be read only	eint32	12ea	4842	Not applicable
Instrument.OEMSupervisorList.Parameter88	Parameter that is to be read only	eint32	12eb	4843	Not applicable
Instrument.OEMSupervisorList.Parameter89	Parameter that is to be read only	eint32	12ec	4844	Not applicable
Instrument.OEMSupervisorList.Parameter90	Parameter that is to be read only	eint32	12ed	4845	Not applicable
Instrument.OEMSupervisorList.Parameter91	Parameter that is to be read only	eint32	12ee	4846	Not applicable
Instrument.OEMSupervisorList.Parameter92	Parameter that is to be read only	eint32	12ef	4847	Not applicable
Instrument.OEMSupervisorList.Parameter93	Parameter that is to be read only	eint32	12f0	4848	Not applicable
Instrument.OEMSupervisorList.Parameter94	Parameter that is to be read only	eint32	12f1	4849	Not applicable
Instrument.OEMSupervisorList.Parameter95	Parameter that is to be read only	eint32	12f2	4850	Not applicable
Instrument.OEMSupervisorList.Parameter96	Parameter that is to be read only	eint32	12f3	4851	Not applicable
Instrument.OEMSupervisorList.Parameter97	Parameter that is to be read only	eint32	12f4	4852	Not applicable
Instrument.OEMSupervisorList.Parameter98	Parameter that is to be read only	eint32	12f5	4853	Not applicable
Instrument.OEMSupervisorList.Parameter99	Parameter that is to be read only	eint32	12f6	4854	Not applicable
Instrument.OEMSupervisorList.Parameter100	Parameter that is to be read only	eint32	12f7	4855	Not applicable
Instrument.User1.Username	User username	string_t	6fc0	28608	Not applicable
Instrument.User1.Password	User password	string_t	6fe0	28640	Not applicable
Instrument.User1.BatchControl	Batch control permission	bool	040c	1036	Not applicable
Instrument.User1.AckAlarms	Acknowledge alarms permission	bool	040d	1037	Not applicable

Parameter path	Description	Type	Hex	Dec	Resolution
Instrument.User1.LoginDisabled	Login disabled	bool	040f	1039	Not applicable
Instrument.User1.Signing	Signing permission	bool	0410	1040	Not applicable
Instrument.User1.Authorising	Authorising permission	bool	0411	1041	Not applicable
Instrument.User1.ArchiveInterval	Archive interval permission	bool	0412	1042	Not applicable
Instrument.User1.LoopControl	Loop control permission	bool	0413	1043	Not applicable
Instrument.User1.ProgramMode	Program mode permission	bool	0414	1044	Not applicable
Instrument.User1.ProgramEdit	Program edit permission	bool	0415	1045	Not applicable
Instrument.User1.ProgramStore	Program store permission	bool	0416	1046	Not applicable
Instrument.User2.Username	User username	string_t	6fc1	28609	Not applicable
Instrument.User2.Password	User password	string_t	6fe1	28641	Not applicable
Instrument.User2.BatchControl	Batch control permission	bool	0417	1047	Not applicable
Instrument.User2.AckAlarms	Acknowledge alarms permission	bool	0418	1048	Not applicable
Instrument.User2.DemandArchiving	Demand archiving permission	bool	0419	1049	Not applicable
Instrument.User2.LoginDisabled	Login disabled	bool	041a	1050	Not applicable
Instrument.User2.Signing	Signing permission	bool	041b	1051	Not applicable
Instrument.User2.Authorising	Authorising permission	bool	041c	1052	Not applicable
Instrument.User2.ArchiveInterval	Archive interval permission	bool	041d	1053	Not applicable
Instrument.User2.LoopControl	Loop control permission	bool	041e	1054	Not applicable
Instrument.User2.ProgramMode	Program mode permission	bool	041f	1055	Not applicable
Instrument.User2.ProgramEdit	Program edit permission	bool	0420	1056	Not applicable
Instrument.User2.ProgramStore	Program store permission	bool	0421	1057	Not applicable
Instrument.User3.Username	User username	string_t	6fc2	28610	Not applicable
Instrument.User3.Password	User password	string_t	6fe2	28642	Not applicable
Instrument.User3.BatchControl	Batch control permission	bool	0422	1058	Not applicable
Instrument.User3.AckAlarms	Acknowledge alarms permission	bool	0423	1059	Not applicable
Instrument.User3.DemandArchiving	Demand archiving permission	bool	0424	1060	Not applicable
Instrument.User3.LoginDisabled	Login disabled	bool	0425	1061	Not applicable
Instrument.User3.Signing	Signing permission	bool	0426	1062	Not applicable
Instrument.User3.Authorising	Authorising permission	bool	0427	1063	Not applicable
Instrument.User3.ArchiveInterval	Archive interval permission	bool	0428	1064	Not applicable
Instrument.User3.LoopControl	Loop control permission	bool	0429	1065	Not applicable
Instrument.User3.ProgramMode	Program mode permission	bool	042a	1066	Not applicable
Instrument.User3.ProgramEdit	Program edit permission	bool	042b	1067	Not applicable
Instrument.User3.ProgramStore	Program store permission	bool	042c	1068	Not applicable
Instrument.User4.Username	User username	string_t	6fc3	28611	Not applicable
Instrument.User4.Password	User password	string_t	6fe3	28643	Not applicable
Instrument.User4.BatchControl	Batch control permission	bool	042d	1069	Not applicable
Instrument.User4.AckAlarms	Acknowledge alarms permission	bool	042e	1070	Not applicable
Instrument.User4.DemandArchiving	Demand archiving permission	bool	042f	1071	Not applicable
Instrument.User4.LoginDisabled	Login disabled	bool	0430	1072	Not applicable
Instrument.User4.Signing	Signing permission	bool	0431	1073	Not applicable
Instrument.User4.Authorising	Authorising permission	bool	0432	1074	Not applicable
Instrument.User4.ArchiveInterval	Archive interval permission	bool	0433	1075	Not applicable
Instrument.User4.LoopControl	Loop control permission	bool	0434	1076	Not applicable
Instrument.User4.ProgramMode	Program mode permission	bool	0435	1077	Not applicable
Instrument.User4.ProgramEdit	Program edit permission	bool	0436	1078	Not applicable
Instrument.User4.ProgramStore	Program store permission	bool	0437	1079	Not applicable
Instrument.User5.Username	User username	string_t	6fc4	28612	Not applicable
Instrument.User5.Password	User password	string_t	6fe4	28644	Not applicable
Instrument.User5.BatchControl	Batch control permission	bool	0438	1080	Not applicable
Instrument.User5.AckAlarms	Acknowledge alarms permission	bool	0439	1081	Not applicable
Instrument.User5.DemandArchiving	Demand archiving permission	bool	043a	1082	Not applicable
Instrument.User5.LoginDisabled	Login disabled	bool	043b	1083	Not applicable
Instrument.User5.Signing	Signing permission	bool	043c	1084	Not applicable
Instrument.User5.Authorising	Authorising permission	bool	043d	1085	Not applicable
Instrument.User5.ArchiveInterval	Archive interval permission	bool	043e	1086	Not applicable
Instrument.User5.LoopControl	Loop control permission	bool	043f	1087	Not applicable
Instrument.User5.ProgramMode	Program mode permission	bool	0440	1088	Not applicable
Instrument.User5.ProgramEdit	Program edit permission	bool	0441	1089	Not applicable
Instrument.User5.ProgramStore	Program store permission	bool	0442	1090	Not applicable
Instrument.User6.Username	User username	string_t	6fc5	28613	Not applicable

Parameter path	Description	Type	Hex	Dec	Resolution
Instrument.User6.BatchControl	Batch control permission	bool	0443	1091	Not applicable
Instrument.User6.AckAlarms	Acknowledge alarms permission	bool	0444	1092	Not applicable
Instrument.User6.DemandArchiving	Demand archiving permission	bool	0445	1093	Not applicable
Instrument.User6.LoginDisabled	Login disabled	bool	0446	1094	Not applicable
Instrument.User6.Signing	Signing permission	bool	0447	1095	Not applicable
Instrument.User6.Authorising	Authorising permission	bool	0448	1096	Not applicable
Instrument.User6.ArchiveInterval	Archive interval permission	bool	0449	1097	Not applicable
Instrument.User6.LoopControl	Loop control permission	bool	044a	1098	Not applicable
Instrument.User6.ProgramMode	Program mode permission	bool	044b	1099	Not applicable
Instrument.User6.ProgramEdit	Program edit permission	bool	044c	1100	Not applicable
Instrument.User6.ProgramStore	Program store permission	bool	044d	1101	Not applicable
Instrument.User7.Username	User username	string_t	6fc6	28614	Not applicable
Instrument.User7.Password	User password	string_t	6fe6	28646	Not applicable
Instrument.User7.BatchControl	Batch control permission	bool	044e	1102	Not applicable
Instrument.User7.AckAlarms	Acknowledge alarms permission	bool	044f	1103	Not applicable
Instrument.User7.DemandArchiving	Demand archiving permission	bool	0450	1104	Not applicable
Instrument.User7.LoginDisabled	Login disabled	bool	0451	1105	Not applicable
Instrument.User7.Signing	Signing permission	bool	0452	1106	Not applicable
Instrument.User7.Authorising	Authorising permission	bool	0453	1107	Not applicable
Instrument.User7.ArchiveInterval	Archive interval permission	bool	0454	1108	Not applicable
Instrument.User7.LoopControl	Loop control permission	bool	0455	1109	Not applicable
Instrument.User7.ProgramMode	Program mode permission	bool	0456	1110	Not applicable
Instrument.User7.ProgramEdit	Program edit permission	bool	0457	1111	Not applicable
Instrument.User7.ProgramStore	Program store permission	bool	0458	1112	Not applicable
Instrument.User8.Username	User username	string_t	6fc7	28615	Not applicable
Instrument.User8.Password	User password	string_t	6fe7	28647	Not applicable
Instrument.User8.BatchControl	Batch control permission	bool	0459	1113	Not applicable
Instrument.User8.AckAlarms	Acknowledge alarms permission	bool	045a	1114	Not applicable
Instrument.User8.DemandArchiving	Demand archiving permission	bool	045b	1115	Not applicable
Instrument.User8.LoginDisabled	Login disabled	bool	045c	1116	Not applicable
Instrument.User8.Signing	Signing permission	bool	045d	1117	Not applicable
Instrument.User8.Authorising	Authorising permission	bool	045e	1118	Not applicable
Instrument.User8.ArchiveInterval	Archive interval permission	bool	045f	1119	Not applicable
Instrument.User8.LoopControl	Loop control permission	bool	0460	1120	Not applicable
Instrument.User8.ProgramMode	Program mode permission	bool	0461	1121	Not applicable
Instrument.User8.ProgramEdit	Program edit permission	bool	0462	1122	Not applicable
Instrument.User8.ProgramStore	Program store permission	bool	0463	1123	Not applicable
Instrument.User9.Username	User username	string_t	6fc8	28616	Not applicable
Instrument.User9.Password	User password	string_t	6fe8	28648	Not applicable
Instrument.User9.BatchControl	Batch control permission	bool	0464	1124	Not applicable
Instrument.User9.AckAlarms	Acknowledge alarms permission	bool	0465	1125	Not applicable
Instrument.User9.DemandArchiving	Demand archiving permission	bool	0466	1126	Not applicable
Instrument.User9.LoginDisabled	Login disabled	bool	0467	1127	Not applicable
Instrument.User9.Signing	Signing permission	bool	0468	1128	Not applicable
Instrument.User9.Authorising	Authorising permission	bool	0469	1129	Not applicable
Instrument.User9.ArchiveInterval	Archive interval permission	bool	046a	1130	Not applicable
Instrument.User9.LoopControl	Loop control permission	bool	046b	1131	Not applicable
Instrument.User9.ProgramMode	Program mode permission	bool	046c	1132	Not applicable
Instrument.User9.ProgramEdit	Program edit permission	bool	046d	1133	Not applicable
Instrument.User9.ProgramStore	Program store permission	bool	046e	1134	Not applicable
Instrument.User10.Username	User username	string_t	6fc9	28617	Not applicable
Instrument.User10.Password	User password	string_t	6fe9	28649	Not applicable
Instrument.User10.BatchControl	Batch control permission	bool	046f	1135	Not applicable
Instrument.User10.AckAlarms	Acknowledge alarms permission	bool	0470	1136	Not applicable
Instrument.User10.DemandArchiving	Demand archiving permission	bool	0471	1137	Not applicable
Instrument.User10.LoginDisabled	Login disabled	bool	0472	1138	Not applicable
Instrument.User10.Signing	Signing permission	bool	0473	1139	Not applicable
Instrument.User10.Authorising	Authorising permission	bool	0474	1140	Not applicable
Instrument.User10.ArchiveInterval	Archive interval permission	bool	0475	1141	Not applicable
Instrument.User10.LoopControl	Loop control permission	bool	0476	1142	Not applicable
Instrument.User10.ProgramMode	Program mode permission	bool	0477	1143	Not applicable

Parameter path	Description	Type	Hex	Dec	Resolution
Instrument.User10.ProgramStore	Program store permission	bool	0479	1145	Not applicable
Instrument.User11.Username	User username	string_t	6fca	28618	Not applicable
Instrument.User11.Password	User password	string_t	6fea	28650	Not applicable
Instrument.User11.BatchControl	Batch control permission	bool	047a	1146	Not applicable
Instrument.User11.AckAlarms	Acknowledge alarms permission	bool	047b	1147	Not applicable
Instrument.User11.DemandArchiving	Demand archiving permission	bool	047c	1148	Not applicable
Instrument.User11.LoginDisabled	Login disabled	bool	047d	1149	Not applicable
Instrument.User11.Signing	Signing permission	bool	047e	1150	Not applicable
Instrument.User11.Authorising	Authorising permission	bool	047f	1151	Not applicable
Instrument.User11.ArchiveInterval	Archive interval permission	bool	0480	1152	Not applicable
Instrument.User11.LoopControl	Loop control permission	bool	0481	1153	Not applicable
Instrument.User11.ProgramMode	Program mode permission	bool	0482	1154	Not applicable
Instrument.User11.ProgramEdit	Program edit permission	bool	0483	1155	Not applicable
Instrument.User11.ProgramStore	Program store permission	bool	0484	1156	Not applicable
Instrument.User12.Username	User username	string_t	6fcb	28619	Not applicable
Instrument.User12.Password	User password	string_t	6feb	28651	Not applicable
Instrument.User12.BatchControl	Batch control permission	bool	0485	1157	Not applicable
Instrument.User12.AckAlarms	Acknowledge alarms permission	bool	0486	1158	Not applicable
Instrument.User12.DemandArchiving	Demand archiving permission	bool	0487	1159	Not applicable
Instrument.User12.LoginDisabled	Login disabled	bool	0488	1160	Not applicable
Instrument.User12.Signing	Signing permission	bool	0489	1161	Not applicable
Instrument.User12.Authorising	Authorising permission	bool	048a	1162	Not applicable
Instrument.User12.ArchiveInterval	Archive interval permission	bool	048b	1163	Not applicable
Instrument.User12.LoopControl	Loop control permission	bool	048c	1164	Not applicable
Instrument.User12.ProgramMode	Program mode permission	bool	048d	1165	Not applicable
Instrument.User12.ProgramEdit	Program edit permission	bool	048e	1166	Not applicable
Instrument.User12.ProgramStore	Program store permission	bool	048f	1167	Not applicable
Instrument.User13.Username	User username	string_t	6fcc	28620	Not applicable
Instrument.User13.Password	User password	string_t	6fec	28652	Not applicable
Instrument.User13.BatchControl	Batch control permission	bool	0490	1168	Not applicable
Instrument.User13.AckAlarms	Acknowledge alarms permission	bool	0491	1169	Not applicable
Instrument.User13.DemandArchiving	Demand archiving permission	bool	0492	1170	Not applicable
Instrument.User13.LoginDisabled	Login disabled	bool	0493	1171	Not applicable
Instrument.User13.Signing	Signing permission	bool	0494	1172	Not applicable
Instrument.User13.Authorising	Authorising permission	bool	0495	1173	Not applicable
Instrument.User13.ArchiveInterval	Archive interval permission	bool	0496	1174	Not applicable
Instrument.User13.LoopControl	Loop control permission	bool	0497	1175	Not applicable
Instrument.User13.ProgramMode	Program mode permission	bool	0498	1176	Not applicable
Instrument.User13.ProgramEdit	Program edit permission	bool	0499	1177	Not applicable
Instrument.User13.ProgramStore	Program store permission	bool	049a	1178	Not applicable
Instrument.User14.Username	User username	string_t	6fcd	28621	Not applicable
Instrument.User14.Password	User password	string_t	6fed	28653	Not applicable
Instrument.User14.BatchControl	Batch control permission	bool	049b	1179	Not applicable
Instrument.User14.AckAlarms	Acknowledge alarms permission	bool	049c	1180	Not applicable
Instrument.User14.DemandArchiving	Demand archiving permission	bool	049d	1181	Not applicable
Instrument.User14.LoginDisabled	Login disabled	bool	049e	1182	Not applicable
Instrument.User14.Signing	Signing permission	bool	049f	1183	Not applicable
Instrument.User14.Authorising	Authorising permission	bool	04a0	1184	Not applicable
Instrument.User14.ArchiveInterval	Archive interval permission	bool	04a1	1185	Not applicable
Instrument.User14.LoopControl	Loop control permission	bool	04a2	1186	Not applicable
Instrument.User14.ProgramMode	Program mode permission	bool	04a3	1187	Not applicable
Instrument.User14.ProgramEdit	Program edit permission	bool	04a4	1188	Not applicable
Instrument.User14.ProgramStore	Program store permission	bool	04a5	1189	Not applicable
Instrument.User15.Username	User username	string_t	6fce	28622	Not applicable
Instrument.User15.Password	User password	string_t	6fee	28654	Not applicable
Instrument.User15.BatchControl	Batch control permission	bool	04a6	1190	Not applicable
Instrument.User15.AckAlarms	Acknowledge alarms permission	bool	04a7	1191	Not applicable
Instrument.User15.DemandArchiving	Demand archiving permission	bool	04a8	1192	Not applicable
Instrument.User15.LoginDisabled	Login disabled	bool	04a9	1193	Not applicable
Instrument.User15.Signing	Signing permission	bool	04aa	1194	Not applicable
Instrument.User15.Authorising	Authorising permission	bool	04ab	1195	Not applicable

Parameter path	Description	Type	Hex	Dec	Resolution
Instrument.User15.LoopControl	Loop control permission	bool	04ad	1197	Not applicable
Instrument.User15.ProgramMode	Program mode permission	bool	04ae	1198	Not applicable
Instrument.User15.ProgramEdit	Program edit permission	bool	04af	1199	Not applicable
Instrument.User15.ProgramStore	Program store permission	bool	04b0	1200	Not applicable
Instrument.User16.Username	User username	string_t	6fcf	28623	Not applicable
Instrument.User16.Password	User password	string_t	6fef	28655	Not applicable
Instrument.User16.BatchControl	Batch control permission	bool	04b1	1201	Not applicable
Instrument.User16.AckAlarms	Acknowledge alarms permission	bool	04b2	1202	Not applicable
Instrument.User16.DemandArchiving	Demand archiving permission	bool	04b3	1203	Not applicable
Instrument.User16.LoginDisabled	Login disabled	bool	04b4	1204	Not applicable
Instrument.User16.Signing	Signing permission	bool	04b5	1205	Not applicable
Instrument.User16.Authorising	Authorising permission	bool	04b6	1206	Not applicable
Instrument.User16.ArchiveInterval	Archive interval permission	bool	04b7	1207	Not applicable
Instrument.User16.LoopControl	Loop control permission	bool	04b8	1208	Not applicable
Instrument.User16.ProgramMode	Program mode permission	bool	04b9	1209	Not applicable
Instrument.User16.ProgramEdit	Program edit permission	bool	04ba	1210	Not applicable
Instrument.User16.ProgramStore	Program store permission	bool	04bb	1211	Not applicable
Instrument.User17.Username	User username	string_t	6fd0	28624	Not applicable
Instrument.User17.Password	User password	string_t	6ff0	28656	Not applicable
Instrument.User17.BatchControl	Batch control permission	bool	04bc	1212	Not applicable
Instrument.User17.AckAlarms	Acknowledge alarms permission	bool	04bd	1213	Not applicable
Instrument.User17.DemandArchiving	Demand archiving permission	bool	04be	1214	Not applicable
Instrument.User17.LoginDisabled	Login disabled	bool	04bf	1215	Not applicable
Instrument.User17.Signing	Signing permission	bool	04c0	1216	Not applicable
Instrument.User17.Authorising	Authorising permission	bool	04c1	1217	Not applicable
Instrument.User17.ArchiveInterval	Archive interval permission	bool	04c2	1218	Not applicable
Instrument.User17.LoopControl	Loop control permission	bool	04c3	1219	Not applicable
Instrument.User17.ProgramMode	Program mode permission	bool	04c4	1220	Not applicable
Instrument.User17.ProgramEdit	Program edit permission	bool	04c5	1221	Not applicable
Instrument.User17.ProgramStore	Program store permission	bool	04c6	1222	Not applicable
Instrument.User18.Username	User username	string_t	6fd1	28625	Not applicable
Instrument.User18.Password	User password	string_t	6ff1	28657	Not applicable
Instrument.User18.BatchControl	Batch control permission	bool	04c7	1223	Not applicable
Instrument.User18.AckAlarms	Acknowledge alarms permission	bool	04c8	1224	Not applicable
Instrument.User18.DemandArchiving	Demand archiving permission	bool	04c9	1225	Not applicable
Instrument.User18.LoginDisabled	Login disabled	bool	04ca	1226	Not applicable
Instrument.User18.Signing	Signing permission	bool	04cb	1227	Not applicable
Instrument.User18.Authorising	Authorising permission	bool	04cc	1228	Not applicable
Instrument.User18.ArchiveInterval	Archive interval permission	bool	04cd	1229	Not applicable
Instrument.User18.LoopControl	Loop control permission	bool	04ce	1230	Not applicable
Instrument.User18.ProgramMode	Program mode permission	bool	04cf	1231	Not applicable
Instrument.User18.ProgramEdit	Program edit permission	bool	04d0	1232	Not applicable
Instrument.User18.ProgramStore	Program store permission	bool	04d1	1233	Not applicable
Instrument.User19.Username	User username	string_t	6fd2	28626	Not applicable
Instrument.User19.Password	User password	string_t	6ff2	28658	Not applicable
Instrument.User19.BatchControl	Batch control permission	bool	04d2	1234	Not applicable
Instrument.User19.AckAlarms	Acknowledge alarms permission	bool	04d3	1235	Not applicable
Instrument.User19.DemandArchiving	Demand archiving permission	bool	04d4	1236	Not applicable
Instrument.User19.LoginDisabled	Login disabled	bool	04d5	1237	Not applicable
Instrument.User19.Signing	Signing permission	bool	04d6	1238	Not applicable
Instrument.User19.Authorising	Authorising permission	bool	04d7	1239	Not applicable
Instrument.User19.ArchiveInterval	Archive interval permission	bool	04d8	1240	Not applicable
Instrument.User19.LoopControl	Loop control permission	bool	04d9	1241	Not applicable
Instrument.User19.ProgramMode	Program mode permission	bool	04da	1242	Not applicable
Instrument.User19.ProgramEdit	Program edit permission	bool	04db	1243	Not applicable
Instrument.User19.ProgramStore	Program store permission	bool	04dc	1244	Not applicable
Instrument.User20.Username	User username	string_t	6fd3	28627	Not applicable
Instrument.User20.Password	User password	string_t	6ff3	28659	Not applicable
Instrument.User20.BatchControl	Batch control permission	bool	04dd	1245	Not applicable
Instrument.User20.AckAlarms	Acknowledge alarms permission	bool	04de	1246	Not applicable
Instrument.User20.DemandArchiving	Demand archiving permission	bool	04df	1247	Not applicable

Parameter path	Description	Type	Hex	Dec	Resolution
Instrument.User20.Signing	Signing permission	bool	04e1	1249	Not applicable
Instrument.User20.Authorising	Authorising permission	bool	04e2	1250	Not applicable
Instrument.User20.ArchiveInterval	Archive interval permission	bool	04e3	1251	Not applicable
Instrument.User20.LoopControl	Loop control permission	bool	04e4	1252	Not applicable
Instrument.User20.ProgramMode	Program mode permission	bool	04e5	1253	Not applicable
Instrument.User20.ProgramEdit	Program edit permission	bool	04e6	1254	Not applicable
Instrument.User20.ProgramStore	Program store permission	bool	04e7	1255	Not applicable
Instrument.User21.Username	User username	string_t	6fd4	28628	Not applicable
Instrument.User21.Password	User password	string_t	6ff4	28660	Not applicable
Instrument.User21.BatchControl	Batch control permission	bool	04e8	1256	Not applicable
Instrument.User21.AckAlarms	Acknowledge alarms permission	bool	04e9	1257	Not applicable
Instrument.User21.DemandArchiving	Demand archiving permission	bool	04ea	1258	Not applicable
Instrument.User21.LoginDisabled	Login disabled	bool	04eb	1259	Not applicable
Instrument.User21.Signing	Signing permission	bool	04ec	1260	Not applicable
Instrument.User21.Authorising	Authorising permission	bool	04ed	1261	Not applicable
Instrument.User21.ArchiveInterval	Archive interval permission	bool	04ee	1262	Not applicable
Instrument.User21.LoopControl	Loop control permission	bool	04ef	1263	Not applicable
Instrument.User21.ProgramMode	Program mode permission	bool	04f0	1264	Not applicable
Instrument.User21.ProgramEdit	Program edit permission	bool	04f1	1265	Not applicable
Instrument.User21.ProgramStore	Program store permission	bool	04f2	1266	Not applicable
Instrument.User22.Username	User username	string_t	6fd5	28629	Not applicable
Instrument.User22.Password	User password	string_t	6ff5	28661	Not applicable
Instrument.User22.BatchControl	Batch control permission	bool	04f3	1267	Not applicable
Instrument.User22.AckAlarms	Acknowledge alarms permission	bool	04f4	1268	Not applicable
Instrument.User22.DemandArchiving	Demand archiving permission	bool	04f5	1269	Not applicable
Instrument.User22.LoginDisabled	Login disabled	bool	04f6	1270	Not applicable
Instrument.User22.Signing	Signing permission	bool	04f7	1271	Not applicable
Instrument.User22.Authorising	Authorising permission	bool	04f8	1272	Not applicable
Instrument.User22.ArchiveInterval	Archive interval permission	bool	04f9	1273	Not applicable
Instrument.User22.LoopControl	Loop control permission	bool	04fa	1274	Not applicable
Instrument.User22.ProgramMode	Program mode permission	bool	04fb	1275	Not applicable
Instrument.User22.ProgramEdit	Program edit permission	bool	04fc	1276	Not applicable
Instrument.User22.ProgramStore	Program store permission	bool	04fd	1277	Not applicable
Instrument.User23.Username	User username	string_t	6fd6	28630	Not applicable
Instrument.User23.Password	User password	string_t	6ff6	28662	Not applicable
Instrument.User23.BatchControl	Batch control permission	bool	04fe	1278	Not applicable
Instrument.User23.AckAlarms	Acknowledge alarms permission	bool	04ff	1279	Not applicable
Instrument.User23.DemandArchiving	Demand archiving permission	bool	0500	1280	Not applicable
Instrument.User23.LoginDisabled	Login disabled	bool	0501	1281	Not applicable
Instrument.User23.Signing	Signing permission	bool	0502	1282	Not applicable
Instrument.User23.Authorising	Authorising permission	bool	0503	1283	Not applicable
Instrument.User23.ArchiveInterval	Archive interval permission	bool	0504	1284	Not applicable
Instrument.User23.LoopControl	Loop control permission	bool	0505	1285	Not applicable
Instrument.User23.ProgramMode	Program mode permission	bool	0506	1286	Not applicable
Instrument.User23.ProgramEdit	Program edit permission	bool	0507	1287	Not applicable
Instrument.User23.ProgramStore	Program store permission	bool	0508	1288	Not applicable
Instrument.User24.Username	User username	string_t	6fd7	28631	Not applicable
Instrument.User24.Password	User password	string_t	6ff7	28663	Not applicable
Instrument.User24.BatchControl	Batch control permission	bool	0509	1289	Not applicable
Instrument.User24.AckAlarms	Acknowledge alarms permission	bool	050a	1290	Not applicable
Instrument.User24.DemandArchiving	Demand archiving permission	bool	050b	1291	Not applicable
Instrument.User24.LoginDisabled	Login disabled	bool	050c	1292	Not applicable
Instrument.User24.Signing	Signing permission	bool	050d	1293	Not applicable
Instrument.User24.Authorising	Authorising permission	bool	050e	1294	Not applicable
Instrument.User24.ArchiveInterval	Archive interval permission	bool	050f	1295	Not applicable
Instrument.User24.LoopControl	Loop control permission	bool	0510	1296	Not applicable
Instrument.User24.ProgramMode	Program mode permission	bool	0511	1297	Not applicable
Instrument.User24.ProgramEdit	Program edit permission	bool	0512	1298	Not applicable
Instrument.User24.ProgramStore	Program store permission	bool	0513	1299	Not applicable
Instrument.User25.Username	User username	string_t	6fd8	28632	Not applicable
Instrument.User25.Password	User password	string_t	6ff8	28664	Not applicable

Parameter path	Description	Type	Hex	Dec	Resolution
Instrument.User25.AckAlarms	Acknowledge alarms permission	bool	0515	1301	Not applicable
Instrument.User25.DemandArchiving	Demand archiving permission	bool	0516	1302	Not applicable
Instrument.User25.LoginDisabled	Login disabled	bool	0517	1303	Not applicable
Instrument.User25.Signing	Signing permission	bool	0518	1304	Not applicable
Instrument.User25.Authorising	Authorising permission	bool	0519	1305	Not applicable
Instrument.User25.ArchiveInterval	Archive interval permission	bool	051a	1306	Not applicable
Instrument.User25.LoopControl	Loop control permission	bool	051b	1307	Not applicable
Instrument.User25.ProgramMode	Program mode permission	bool	051c	1308	Not applicable
Instrument.User25.ProgramEdit	Program edit permission	bool	051d	1309	Not applicable
Instrument.User25.ProgramStore	Program store permission	bool	051e	1310	Not applicable
Instrument.Security.CommsPass	1 = Password required for comms access	bool	10c1	4289	Not applicable
Instrument.Security.DefaultConfig	1 = set all parameters to factory settings	bool	10c2	4290	Not applicable
Instrument.Security.EngineerAccess	1 = Engineer access required	bool	10c0	4288	Not applicable
Instrument.Security.EngineerPassword	Engineer pass phrase (default 100)	string_t	63d3	25555	Not applicable
Instrument.Security.Feature2Pass	Features2 pass code	int32	10c4	4292	Not applicable
Instrument.Security.Feature3Pass	Features3 pass code	int32	10c5	4293	Not applicable
Instrument.Security.FeaturePass	Features pass code	int32	10c3	4291	Not applicable
Instrument.Security.OEMEntry	OEM pass phrase entry	string_t	6d61	28001	Not applicable
Instrument.Security.OEMParamLists	OEM Parameter Lists	bool	10c7	4295	Not applicable
Instrument.Security.OEMPass	OEM pass phrase	string_t	6d30	27952	Not applicable
Instrument.Security.OEMStatus	OEM status (0 = Unlocked; 1 = Locked)	bool	10c6	4294	Not applicable
Instrument.Security.OperatorPassword	Operator pass phrase (default = 100)	string_t	6437	25655	Not applicable
Instrument.Security.PassPhrase	The parameter to be written to if comms security is enabled	string_t	4416	17430	Not applicable
Instrument.Security.SupervisorPassword	Supervisor pass phrase (default = blank	string_t	6405	25605	Not applicable
Lgc2.1.FallbackType	Fallback Condition 0 = Output False; Status Bad. 1 = Output True; Status Bad 2 = Output False; Status Good. 3 = Output True; Status good	uint8	2efb	12027	Not applicable
Lgc2.1.In1	Input Value 1	float32	2ef9	12025	0dp
Lgc2.1.In2	Input Value 2	float32	2efa	12026	0dp
Lgc2.1.Invert	Sense of Input Values 0 = Neither input inverted 1 = Input 1 inverted 2 = Input 2 inverted 3 = Both inputs inverted	uint8	2efc	12028	Not applicable
Lgc2.1.Oper	Logic Operation 0 = Off; 1 = AND; 2 = OR; 3 = XOR; 4 = 1 set/2 reset 5 = Input 1 = Input 2 6 = Input 1 ? Input 2 7 = Input 1 > Input 2 8 = Input 1 < Input 2 9 = Input 1 = Input 2; 10 = Input 1 = Input 2	uint8	2ef8	12024	Not applicable
Lgc2.1.Out	Output Value (0 = Off (false); 1 = On (true))	bool	2efd	12029	Not applicable
Lgc2.1.OutputStatus	Output Status (0 = Good; 1 = Bad)	uint8	2efe	12030	Not applicable
Lgc2.2.FallbackType	Fallback Condition (as Lgc2.1.FallbackType)	uint8	2f02	12034	Not applicable
Lgc2.2.In1	Input Value 1	float32	2f00	12032	0dp
Lgc2.2.In2	Input Value 2	float32	2f01	12033	0dp
Lgc2.2.Invert	Sense of Input Value (as Lgc2.1.Invert)	uint8	2f03	12035	Not applicable
Lgc2.2.Oper	Logic Operation (as Lgc2.1.Oper)	uint8	2eff	12031	Not applicable
Lgc2.2.Out	The result of the logic operation (as Lgc2.1.Out)	bool	2f04	12036	Not applicable
Lgc2.2.OutputStatus	Output Status (0 = Good; 1 = Bad)	uint8	2f05	12037	Not applicable
Lgc2.3.FallbackType	Fallback Condition (as Lgc2.1.FallbackType)	uint8	2f09	12041	Not applicable
Lgc2.3.In1	Input Value 1	float32	2f07	12039	0dp
Lgc2.3.In2	Input Value 2	float32	2f08	12040	0dp
Lgc2.3.Invert	Sense of Input Value (as Lgc2.1.Invert)	uint8	2f0a	12042	Not applicable
Lgc2.3.Oper	Logic Operation (as Lgc2.1.Oper)	uint8	2f06	12038	Not applicable
Lgc2.3.Out	The result of the logic operation (as Lgc2.1.Out)	bool	2f0b	12043	Not applicable
Lgc2.3.OutputStatus	Output Status (0 = Good; 1 = Bad)	uint8	2f0c	12044	Not applicable

Parameter path	Description	Type	Hex	Dec	Resolution
Lgc2.4.In1	Input Value 1	float32	2f0e	12046	0dp
Lgc2.4.In2	Input Value 2	float32	2f0f	12047	0dp
Lgc2.4.Invert	Sense of Input Value (as Lgc2.1.Invert)	uint8	2f11	12049	Not applicable
Lgc2.4.Oper	Logic Operation (as Lgc2.1.Oper)	uint8	2f0d	12045	Not applicable
Lgc2.4.Out	The result of the logic operation (as Lgc2.1.Out)	bool	2f12	12050	Not applicable
Lgc2.4.OutputStatus	Output Status (0 = Good; 1 = Bad)	uint8	2f13	12051	Not applicable
Lgc2.5.FallbackType	Fallback Condition (as Lgc2.1.FallbackType)	uint8	2f17	12055	Not applicable
Lgc2.5.In1	Input Value 1	float32	2f15	12053	0dp
Lgc2.5.In2	Input Value 2	float32	2f16	12054	0dp
Lgc2.5.Invert	Sense of Input Value (as Lgc2.1.Invert)	uint8	2f18	12056	Not applicable
Lgc2.5.Oper	Logic Operation (as Lgc2.1.Oper)	uint8	2f14	12052	Not applicable
Lgc2.5.Out	The result of the logic operation (as Lgc2.1.Out)	bool	2f19	12057	Not applicable
Lgc2.5.OutputStatus	Output Status (0 = Good; 1 = Bad)	uint8	2f1a	12058	Not applicable
Lgc2.6.FallbackType	Fallback Condition (as Lgc2.1.FallbackType)	uint8	2f1e	12062	Not applicable
Lgc2.6.In1	Input Value 1	float32	2f1c	12060	0dp
Lgc2.6.In2	Input Value 2	float32	2f1d	12061	0dp
Lgc2.6.Invert	Sense of Input Value (as Lgc2.1.Invert)	uint8	2f1f	12063	Not applicable
Lgc2.6.Oper	Logic Operation (as Lgc2.1.Oper)	uint8	2f1b	12059	Not applicable
Lgc2.6.Out	The result of the logic operation (as Lgc2.1.Out)	bool	2f20	12064	Not applicable
Lgc2.6.OutputStatus	Output Status (0 = Good; 1 = Bad)	uint8	2f21	12065	Not applicable
Lgc2.7.FallbackType	Fallback Condition (as Lgc2.1.FallbackType)	uint8	2f25	12069	Not applicable
Lgc2.7.In1	Input Value 1	float32	2f23	12067	0dp
Lgc2.7.In2	Input Value 2	float32	2f24	12068	0dp
Lgc2.7.Invert	Sense of Input Value (as Lgc2.1.Invert)	uint8	2f26	12070	Not applicable
Lgc2.7.Oper	Logic Operation (as Lgc2.1.Oper)	uint8	2f22	12066	Not applicable
Lgc2.7.Out	The result of the logic operation (as Lgc2.1.Out)	bool	2f27	12071	Not applicable
Lgc2.7.OutputStatus	Output Status (0 = Good; 1 = Bad)	uint8	2f28	12072	Not applicable
Lgc2.8.FallbackType	Fallback Condition (as Lgc2.1.FallbackType)	uint8	2f2c	12076	Not applicable
Lgc2.8.In1	Input Value 1	float32	2f2a	12074	0dp
Lgc2.8.In2	Input Value 2	float32	2f2b	12075	0dp
Lgc2.8.Invert	Sense of Input Value (as Lgc2.1.Invert)	uint8	2f2d	12077	Not applicable
Lgc2.8.Oper	Logic Operation (as Lgc2.1.Oper)	uint8	2f29	12073	Not applicable
Lgc2.8.Out	The result of the logic operation (as Lgc2.1.Out)	bool	2f2e	12078	Not applicable
Lgc2.8.OutputStatus	Output Status (0 = Good; 1 = Bad)	uint8	2f2f	12079	Not applicable
Lgc2.9.FallbackType	Fallback Condition (as Lgc2.1.FallbackType)	uint8	2f33	12083	Not applicable
Lgc2.9.In1	Input Value 1	float32	2f31	12081	0dp
Lgc2.9.In2	Input Value 2	float32	2f32	12082	0dp
Lgc2.9.Invert	Sense of Input Value (as Lgc2.1.Invert)	uint8	2f34	12084	Not applicable
Lgc2.9.Oper	Logic Operation (as Lgc2.1.Oper)	uint8	2f30	12080	Not applicable
Lgc2.9.Out	The result of the logic operation (as Lgc2.1.Out)	bool	2f35	12085	Not applicable
Lgc2.9.OutputStatus	Output Status (0 = Good; 1 = Bad)	uint8	2f36	12086	Not applicable
Lgc2.10.FallbackType	Fallback Condition (as Lgc2.1.FallbackType)	uint8	2f3a	12090	Not applicable
Lgc2.10.In1	Input Value 1	float32	2f38	12088	0dp
Lgc2.10.In2	Input Value 2	float32	2f39	12089	0dp
Lgc2.10.Invert	Sense of Input Value (as Lgc2.1.Invert)	uint8	2f3b	12091	Not applicable
Lgc2.10.Oper	Logic Operation (as Lgc2.1.Oper)	uint8	2f37	12087	Not applicable
Lgc2.10.Out	The result of the logic operation (as Lgc2.1.Out)	bool	2f3c	12092	Not applicable
Lgc2.10.OutputStatus	Output Status (0 = Good; 1 = Bad)	uint8	2f3d	12093	Not applicable
Lgc2.11.FallbackType	Fallback Condition (as Lgc2.1.FallbackType)	uint8	2f41	12097	Not applicable
Lgc2.11.In1	Input Value 1	float32	2f3f	12095	0dp
Lgc2.11.In2	Input Value 2	float32	2f40	12096	0dp
Lgc2.11.Invert	Sense of Input Value (as Lgc2.1.Invert)	uint8	2f42	12098	Not applicable
Lgc2.11.Oper	Logic Operation (as Lgc2.1.Oper)	uint8	2f3e	12094	Not applicable
Lgc2.11.Out	The result of the logic operation (as Lgc2.1.Out)	bool	2f43	12099	Not applicable

Parameter path	Description	Type	Hex	Dec	Resolution
Lgc2.12.FallbackType	Fallback Condition (as Lgc2.1.FallbackType)	uint8	2f48	12104	Not applicable
Lgc2.12.In1	Input Value 1	float32	2f46	12102	0dp
Lgc2.12.In2	Input Value 2	float32	2f47	12103	0dp
Lgc2.12.Invert	Sense of Input Value (as Lgc2.1.Invert)	uint8	2f49	12105	Not applicable
Lgc2.12.Oper	Logic Operation (as Lgc2.1.Oper)	uint8	2f45	12101	Not applicable
Lgc2.12.Out	The result of the logic operation (as Lgc2.1.Out)	bool	2f4a	12106	Not applicable
Lgc2.12.OutputStatus	Output Status (0 = Good; 1 = Bad)	uint8	2f4b	12107	Not applicable
Lgc8.1.In1	Input 1 Value (0 = Off; 1 = On)	bool	2f4f	12111	Not applicable
Lgc8.1.In2	Input 2 Value (0 = Off; 1 = On)	bool	2f50	12112	Not applicable
Lgc8.1.In3	Input 3 Value (0 = Off; 1 = On)	bool	2f51	12113	Not applicable
Lgc8.1.In4	Input 4 Value (0 = Off; 1 = On)	bool	2f52	12114	Not applicable
Lgc8.1.In5	Input 5 Value (0 = Off; 1 = On)	bool	2f53	12115	Not applicable
Lgc8.1.In6	Input 6 Value (0 = Off; 1 = On)	bool	2f54	12116	Not applicable
Lgc8.1.In7	Input 7 Value (0 = Off; 1 = On)	bool	2f55	12117	Not applicable
Lgc8.1.In8	Input 8 Value (0 = Off; 1 = On)	bool	2f56	12118	Not applicable
Lgc8.1.InInvert	Invert Selected Inputs (See also section 4.20.3) Hex0001 = invert input 1 Hex0010 = invert input 5 Hex0002 = invert input 2 Hex0020 = invert input 6 Hex0003 = invert input 3 Hex0030 = invert input 7 Hex0004 = invert input 4 Hex0040 = invert input 8	uint8	2f4d	12109	Not applicable
Lgc8.1.NumIn	Number of Inputs	uint8	2f4e	12110	Not applicable
Lgc8.1.Oper	Logic Operation (0 = Off; 1 = AND; 2 = OR; 3 = XOR)	uint8	2f4c	12108	Not applicable
Lgc8.1.Out	Output Value (0 = Off (false); 1 = On (true))	bool	2f57	12119	Not applicable
Lgc8.1.OutInvert	Invert the Output (0 = No; 1 = Yes)	bool	2f58	12120	Not applicable
Lgc8.2.In1	Input 1 Value (0 = Off; 1 = On)	bool	2f5c	12124	Not applicable
Lgc8.2.In2	Input 2 Value (0 = Off; 1 = On)	bool	2f5d	12125	Not applicable
Lgc8.2.In3	Input 3 Value (0 = Off; 1 = On)	bool	2f5e	12126	Not applicable
Lgc8.2.In4	Input 4 Value (0 = Off; 1 = On)	bool	2f5f	12127	Not applicable
Lgc8.2.In5	Input 5 Value (0 = Off; 1 = On)	bool	2f60	12128	Not applicable
Lgc8.2.In6	Input 6 Value (0 = Off; 1 = On)	bool	2f61	12129	Not applicable
Lgc8.2.In7	Input 7 Value (0 = Off; 1 = On)	bool	2f62	12130	Not applicable
Lgc8.2.In8	Input 8 Value (0 = Off; 1 = On)	bool	2f63	12131	Not applicable
Lgc8.2.InInvert	Invert Selected Inputs (as Lgc8.1.InInvert)	uint8	2f5a	12122	Not applicable
Lgc8.2.NumIn	Number of Inputs	uint8	2f5b	12123	Not applicable
Lgc8.2.Oper	Logic Operation (0 = Off; 1 = AND; 2 = OR; 3 = XOR)	uint8	2f59	12121	Not applicable
Lgc8.2.Out	Output Value (as Lgc8.1.Out)	bool	2f64	12132	Not applicable
Lgc8.2.OutInvert	Invert the Output (0 = No; 1 = Yes)	bool	2f65	12133	Not applicable
Loop.1.Diag.DerivativeOutContrib	Derivative Output Contribution	float32	0212	530	0dp
Loop.1.Diag.Error	Calculated error	float32	020d	525	Same as Loop.1.Main.PV
Loop.1.Diag.IntegralOutContrib	Integral Output Contribution	float32	0211	529	0dp
Loop.1.Diag.LoopBreakAlarm	Loop Break (0 = No break; 1 = Break)	bool	020f	527	Not applicable
Loop.1.Diag.LoopMode	Mode of the Loop (0 = Auto; 1 = Man; 2 = Off)	uint8	1691	5777	Not applicable
Loop.1.Diag.PropOutContrib	Proportional Output Contribution	float32	0210	528	0dp
Loop.1.Diag.SBrk	Sensor Break Status (0 = No break; 1 = Break)	bool	0213	531	Not applicable
Loop.1.Diag.SchedCBH	The Scheduled Cutback High (0 = Auto)	float32	1695	5781	0dp
Loop.1.Diag.SchedCBL	The Scheduled Cutback Low (0 = Auto)	float32	1696	5782	0dp
Loop.1.Diag.SchedLPBrk	The Scheduled Loop Break Time (0 = Off)	float32	1698	5784	0dp
Loop.1.Diag.SchedMR	The Scheduled Manual Reset	float32	1697	5783	1dp
Loop.1.Diag.SchedOPHi	The Scheduled Output High Limit	float32	169a	5786	1dp
Loop.1.Diag.SchedOPLo	The Scheduled Output Low Limit	float32	169b	5787	1dp
Loop.1.Diag.SchedPB	The Scheduled Proportional Band	float32	1692	5778	1dp
Loop.1.Diag.SchedR2G	The Scheduled Relative Cool Gain	float32	1699	5785	1dp
Loop.1.Diag.SchedTd	The Scheduled Derivative Time (0 = Off)	float32	1694	5780	0dp
Loop.1.Diag.SchedTi	The Scheduled Integral Time (0 = Off)	float32	1693	5779	0dp
Loop.1.Diag.TargetOutVal	Target Output value	float32	020e	526	Same as Loop.1.OP.OutputHighLimit
Loop.1.Diag.WrkOPHi	Working Output High Limit	float32	0215	533	0dp
Loop.1.Diag.WrkOPLo	Working Output Low Limit	float32	0214	532	0dp
Loop.1.Main.ActiveOut	Working Output	float32	0204	516	Same as Loop.1.OP.OutputHighLimit

Parameter path	Description	Type	Hex	Dec	Resolution
Loop.1.Main.Inhibit	Control Inhibit (0 = No; 1 = Yes)	bool	0205	517	Not applicable
Loop.1.Main.IntHold	Integral action inhibit. 0 = No; 1 = Yes	uint8	0206	518	Not applicable
Loop1.Main.PV	Process variable	float32	0200	512	1dp
Loop.1.Main.TargetSP	Target Setpoint	float32	0202	514	Same as Loop.1.Main.PV
Loop.1.Main.WorkingSP	Working Setpoint	float32	0203	515	Same as Loop.1.Main.PV
Loop.1.OP.Ch1OnOffHysteresis	Ch1 On/Off Hysteresis in Engineering Units	float32	1672	5746	Same as Loop.1.Main.PV
Loop.1.OP.Ch1Out	Channel 1 Output Value	float32	020b	523	Same as Loop.1.OP.OutputHighLimit
Loop.1.OP.Ch1PotBreak	Ch1 Potentiometer Break (0 = Off; 1 = On)	uint8	1679	5753	Not applicable
Loop.1.OP.Ch1PotPosition	Ch1 Valve Position	float32	1678	5752	0dp
Loop.1.OP.Ch1TravelTime	Channel 1 Travel Time	float32	1674	5748	1dp
Loop.1.OP.Ch2Deadband	Channel 2 Deadband	float32	166f	5743	Same as Loop.1.OP.OutputHighLimit
Loop.1.OP.Ch2OnOffHysteresis	Ch2 On/Off Hysteresis in Eng Units	float32	1673	5747	Same as Loop.1.Main.PV
Loop.1.OP.Ch2Out	Channel 2 (Cool) Output Value	float32	020c	524	Same as Loop.1.OP.OutputHighLimit
Loop.1.OP.Ch2PotBreak	Ch2 Potentiometer Break (0 = Off; 1 = On)	uint8	167b	5755	Not applicable
Loop.1.OP.Ch2PotPosition	Ch2 Valve Position	float32	167a	5754	0dp
Loop.1.OP.Ch2TravelTime	Channel 2 Travel Time	float32	1675	5749	1dp
Loop.1.OP.CoolType	Cooling Algorithm Type 0 = Linear 1 = Oil 2 = Water 3 = Fan	uint8	1683	5763	Not applicable
Loop.1.OP.EnablePowerFeedforward	0 = Power Feedforward disabled; 1 = PFF enabled	uint8	1681	5761	Not applicable
Loop.1.OP.FeedForwardGain	Feedforward Gain	float32	1685	5765	3dp
Loop.1.OP.FeedForwardOffset	Feedforward Offset	float32	1686	5766	0dp
Loop.1.OP.FeedForwardTrimLimit	Feedforward Trim Limit	float32	1687	5767	0dp
Loop.1.OP.FeedForwardType	Feedforward Type (0 = None; 1 = Remote; 2 = SP; 3 = PV)	uint8	1684	5764	Not applicable
Loop.1.OP.FeedForwardVal	Feedforward Value	float32	1688	5768	0dp
Loop.1.OP.FF_Rem	Remote Feed Forward Input	float32	168d	5773	0dp
Loop.1.OP.ForcedOP	Forced manual output value	float32	168f	5775	1dp
Loop.1.OP.ManStartup	Manual Startup Mode (0 = Off; 1 = On)	bool	1690	5776	Not applicable
Loop.1.OP.ManualMode	Manual Output Mode (0 = Track; 1 = Step; 2 = Last MOP)	uint8	167f	5759	Not applicable
Loop.1.OP.ManualOutVal	Manual Output Value	float32	1680	5760	Same as Loop.1.OP.OutputHighLimit
Loop.1.OP.MeasuredPower	Measured Mains Voltage	float32	1682	5762	0dp
Loop.1.OP.NudgeLower	Valve Nudge Lower (1 = Lower)	uint8	1677	5751	Not applicable
Loop.1.OP.NudgeRaise	Valve Nudge Raise (1 = Raise)	uint8	1676	5750	Not applicable
Loop.1.OP.OutputHighLimit	Output High Limit	float32	166d	5741	1dp
Loop.1.OP.OutputLowLimit	Output Low Limit	float32	166e	5742	Same as Loop.1.OP.OutputHighLimit
Loop.1.OP.PotBreakMode	Potentiometer Break Mode (0 = Raise; 1 = Lower; 2 = Rest; 3 = Model)	uint8	167c	5756	Not applicable
Loop.1.OP.Rate	Output Rate Limit Value (0 = Off)	float32	1670	5744	1dp
Loop.1.OP.RateDisable	Output Rate Limit Disable (1 = Disabled)	bool	1671	5745	Not applicable
Loop.1.OP.RemOPH	Remote Output High Limit	float32	168c	5772	Same as Loop.1.Main.ActiveOut
Loop.1.OP.RemOPL	Remote Output Low Limit	float32	168b	5771	Same as Loop.1.Main.ActiveOut
Loop.1.OP.SafeOutVal	Safe Output Value	float32	167e	5758	Same as Loop.1.OP.OutputHighLimit
Loop.1.OP.SbrkOP	The output power in sensor break	float32	168e	5774	Same as Loop.1.OP.OutputHighLimit
Loop.1.OP.SensorBreakMode	Sensor Break Mode (0 = SbrkOP; 1 = Hold)	uint8	167d	5757	Not applicable
Loop.1.OP.TrackEnable	Enable Output Tracking (0 = Disabled; 1 = Enabled)	uint8	168a	5770	Not applicable
Loop.1.OP.TrackOutVal	Output Track Value	float32	1689	5769	0dp
Loop.1.PID.ActiveSet	Current PID Set	uint8	1638	5688	Not applicable
Loop.1.PID.Boundary1-2	Threshold for swapping between set 1 and set 2	float32	1639	5689	0dp
Loop.1.PID.Boundary2-3	Threshold for swapping between set 2 and set 3	float32	163a	5690	0dp
Loop.1.PID.CutbackHigh	Cutback high value for PID set 1 (0 = Auto)	float32	163f	5695	1dp
Loop.1.PID.CutbackHigh2	Cutback high value for PID set 2 (0 = Auto)	float32	1647	5703	1dp
Loop.1.PID.CutbackHigh3	Cutback high value for PID set 3 (0 = Auto)	float32	164f	5711	1dp
Loop.1.PID.CutbackLow	Cutback low value for PID set 1 (0 = Auto)	float32	1640	5696	1dp
Loop.1.PID.CutbackLow2	Cutback low value for PID set 2 (0 = Auto)	float32	1648	5704	1dp
Loop.1.PID.CutbackLow3	Cutback low value for PID set 3 (0 = Auto)	float32	1650	5712	1dp
Loop.1.PID.DerivativeTime	Derivative time for PID set 1	float32	163d	5693	0dp
Loop.1.PID.DerivativeTime2	Derivative time for PID set 2	float32	1645	5701	0dp
Loop.1.PID.DerivativeTime3	Derivative time for PID set 3	float32	164d	5709	0dp
Loop.1.PID.IntegralTime	Integral time for PID set 1	float32	163c	5692	0dp
Loop.1.PID.IntegralTime2	Integral time for PID set 2	float32	1644	5700	0dp
Loop.1.PID.IntegralTime3	Integral time for PID set 3	float32	164e	5708	0dp

Parameter path	Description	Type	Hex	Dec	Resolution
Loop.1.PID.LoopBreakTime2	Loop break time for PID set 2	float32	164a	5706	0dp
Loop.1.PID.LoopBreakTime3	Loop break time for PID set 3	float32	1652	5714	0dp
Loop.1.PID.ManualReset	Manual reset value for PID set 1	float32	1641	5697	1dp
Loop.1.PID.ManualReset2	Manual reset value for PID set 2	float32	1649	5705	1dp
Loop.1.PID.ManualReset3	Manual reset value for PID set 3	float32	1651	5713	1dp
Loop.1.PID.NumSets	Number of PID Sets to be used (max = 3)	uint8	1636	5686	Not applicable
Loop.1.PID.OutputHi	Gain scheduled output high limit for PID set 1	float32	1653	5715	1dp
Loop.1.PID.OutputHi2	Gain scheduled output high limit for PID set 2	float32	1655	5717	1dp
Loop.1.PID.OutputHi3	Gain scheduled output high limit for PID set 3	float32	1657	5719	1dp
Loop.1.PID.OutputLo	Gain scheduled output low limit for PID set 1	float32	1654	5716	1dp
Loop.1.PID.OutputLo2	Gain scheduled output low limit for PID set 2	float32	1656	5718	1dp
Loop.1.PID.OutputLo3	Gain scheduled output low limit for PID set 3	float32	1658	5720	1dp
Loop.1.PID.ProportionalBand	Proportional band value for PID set 1	float32	163b	5691	1dp
Loop.1.PID.ProportionalBand2	Proportional band value for PID set 2	float32	1643	5699	1dp
Loop.1.PID.ProportionalBand3	Proportional band value for PID set 3	float32	164b	5707	1dp
Loop.1.PID.RelCh2Gain	Channel 2 relative cool gain value for PID set 1	float32	163e	5694	1dp
Loop.1.PID.RelCh2Gain2	Channel 2 relative cool gain value for PID set 2	float32	1646	5702	1dp
Loop.1.PID.RelCh2Gain3	Channel 2 relative cool gain value for PID set 3	float32	164e	5710	1dp
Loop.1.PID.SchedulerRemoteInput	Scheduler Remote Input	float32	1637	5687	0dp
Loop.1.PID.SchedulerType	Scheduler Type 0 = Off 1 = Set 2 = SP 3 = PV 4 = Error 5 = OP 6 = Rem	uint8	1635	5685	Not applicable
Loop.1.Setup.AutoManAccess	Edit access to 'Auto Man' in Loop display page 0 = Read/Write (R/W) all modes 1 = Editable in all modes except 'Logged out' 2 = Editable only at Engineer and Supervisor levels	uint8	16a8	5800	Not applicable
Loop.1.Setup.CH1ControlType	Heat/Ch1 Control Type 0 = Off; 1 = On Off; 2 = PID; 3 = VPU; 4 = VPB	uint8	1601	5633	Not applicable
Loop.1.Setup.CH2ControlType	Channel 2 control type (As channel 1, above)	uint8	1602	5634	Not applicable
Loop.1.Setup.ControlAction	Control Action (0 = Reverse; 1 = Direct)	uint8	1603	5635	Not applicable
Loop.1.Setup.DerivativeType	Derivative Type (0 = PV; 1 = Error)	uint8	1605	5637	Not applicable
Loop.1.Setup.ManOutputAccess	Manual output access	uint8	16a9	5801	Not applicable
Loop.1.Setup.LoopName	Loop Name	string_t	5d00	23808	Not applicable
Loop.1.Setup.LoopType	Loop Type (0 = Single; 1 = Cascade; 2 = Override; 3 = Ratio)	uint8	1600	5632	Not applicable
Loop.1.Setup.PBUnits	Proportional Band Units	uint8	1604	5636	Not applicable
Loop.1.Setup.SPAccess	Edit access to 'SP' in Loop display page 0 = Read/Write (R/W) all modes 1 = Editable in all modes except 'Logged out' 2 = Editable only at Engineer and Supervisor levels	uint8	16a7	5799	Not applicable
Loop.1.SP.AltSP	Alternative Setpoint	float32	1660	5728	Same as Loop.1.Main.PV
Loop.1.SP.AltSPSelect	Alternative Setpoint Enable (0 = disable; 1 = enable)	uint8	1661	5729	Not applicable
Loop.1.SP.ManualTrack	Manual Track Enable (0 = disable; 1 = enable)	uint8	1667	5735	Not applicable
Loop.1.SP.RangeHigh	Setpoint Range High Limit	float32	1659	5721	Same as Loop.1.Main.PV
Loop.1.SP.RangeLow	Setpoint Range Low Limit	float32	165a	5722	Same as Loop.1.Main.PV
Loop.1.SP.Rate	Setpoint Rate Limit Value (0 = Rate limit off)	float32	1662	5730	Same as Loop.1.Main.PV
Loop.1.SP.RateDisable	Setpoint Rate Limit Disable (0 = No; 1 = Yes)	bool	1663	5731	Not applicable
Loop.1.SP.RateDone	Setpoint Rate Limit Complete (0 = No; 1 = Yes)	bool	020a	522	Not applicable
Loop.1.SP.ServoToPV	Servo to PV Enable (0 = No; 1 = Yes)	bool	166c	5740	Not applicable
Loop.1.SP.SP1	Setpoint 1	float32	165c	5724	Same as Loop.1.Main.PV
Loop.1.SP.SP2	Setpoint 2	float32	165d	5725	Same as Loop.1.Main.PV
Loop.1.SP.SPHighLimit	Setpoint High Limit	float32	165e	5726	Same as Loop.1.Main.PV
Loop.1.SP.SPIntBal	SP Integral Balance (0 = Off; 1 = On)	bool	166b	5739	Not applicable
Loop.1.SP.SPLowLimit	Setpoint Low Limit	float32	165f	5727	Same as Loop.1.Main.PV
Loop.1.SP.SPSelect	Active Setpoint Select (0 = SP1; 1 = SP2)	uint8	165b	5723	Not applicable
Loop.1.SP.SPTrack	Enables setpoint tracking (0 = Off; 1 = On)	uint8	1668	5736	Not applicable
Loop.1.SP.SPTrim	Setpoint Trim value	float32	1664	5732	Same as Loop.1.Main.PV
Loop.1.SP.SPTrimHighLimit	Setpoint Trim High Limit	float32	1665	5733	Same as Loop.1.Main.PV
Loop.1.SP.SPTrimLowLimit	Setpoint Trim Low Limit	float32	1666	5734	Same as Loop.1.Main.PV
Loop.1.SP.TrackPV	Track PV	float32	1669	5737	Same as Loop.1.Main.PV
Loop.1.SP.TrackSP	Manual Tracking Value	float32	166a	5738	Same as Loop.1.Main.PV
Loop.1.Type.Alpha	Alpha	float32	166d	5741	1dp

Parameter path	Description	Type	Hex	Dec	Resolution
Loop.1.Tune.AutotuneEnable	Autotune Enable (0 = Autotune Off; 1 = on)	bool	1631	5681	Not applicable
Loop.1.Tune.CycleNo	CycleNo	float32	16af	5807	0dp
Loop.1.Tune.Debug	Debug	float32	16ae	5806	2dp
Loop.1.Tune.Diagnostics	Tuning diagnostics	bool	31cd	12749	Not applicable
Loop.1.Tune.OPss	OPss	float32	16ac	5804	2dp
Loop.1.Tune.OutputHighLimit	Autotune High Output Power Limit	float32	1632	5682	Same as Loop.1.OP.OutputHighLimit
Loop.1.Tune.OutputLowLimit	Autotune Low Output Power Limit	float32	1633	5683	Same as Loop.1.OP.OutputHighLimit
Loop.1.Tune.PBs	PBs	float32	16b0	5808	2dp
Loop.1.Tune.Settle	Settle	float32	16b2	5810	2dp
Loop.1.Tune.Stage	Autotune stage 0 = Reset 1 = None 2 = Monitor 3 = Current SP 4 = NewSP 5 = ToSp 6 = Max 7 = Min	uint8	0208	520	Not applicable
Loop.1.Tune.StageTime	Time in this Stage of Tune	float32	0209	521	0dp
Loop.1.Tune.State	Tune status 0 = Off 1 = Ready 2 = Running 3 = Complete 4 = Timeout 5 = Ti Limit 6 = R2g limit	uint8	0207	519	Not applicable
Loop.1.Tune.TDs	TDs	float32	16b1	5809	2dp
Loop.1.Tune.TuneR2G	R2G Tuning Type	uint8	1607	5639	Not applicable
Loop.1.Tune.Tuning	Tuning	float32	16aa	5802	0dp
Loop.1.Tune.Type	Autotune Algorithm Type (0 = Cycle; 1 = Single; 2 = Adaptive; 3 = R2GPD)	uint8	1630	5680	Not applicable
Loop.2.Diag.DerivativeOutContrib	Derivative Output Contribution	float32	0292	658	0dp
Loop.2.Diag.Error	Calculated Error	float32	028d	653	Same as Loop.2.Main.PV
Loop.2.Diag.IntegralOutContrib	Integral Output Contribution	float32	0291	657	0dp
Loop.2.Diag.LoopBreakAlarm	Loop Break (0 = No break; 1 = Break)	bool	028f	655	Not applicable
Loop.2.Diag.LoopMode	Loop mode (0 = Auto; 1 = Man; 2 = Off)	uint8	1791	6033	Not applicable
Loop.2.Diag.PropOutContrib	Proportional Output Contribution	float32	0290	656	0dp
Loop.2.Diag.SBrk	Sensor break status (0 = No break; 1 = Break)	bool	0293	659	Not applicable
Loop.2.Diag.SchedCBH	The Scheduled Cutback Hi (0 = Auto)	float32	1795	6037	0dp
Loop.2.Diag.SchedCBL	The Scheduled Cutback Lo (0 = Auto)	float32	1796	6038	0dp
Loop.2.Diag.SchedLPBrk	The Scheduled Loop Break Time	float32	1798	6040	0dp
Loop.2.Diag.SchedMR	The Scheduled Manual Reset	float32	1797	6039	1dp
Loop.2.Diag.SchedOPHi	The Scheduled Output High Limit	float32	179a	6042	1dp
Loop.2.Diag.SchedOPLo	The Scheduled Output Low Limit	float32	179b	6043	1dp
Loop.2.Diag.SchedPB	The Scheduled Proportional Band	float32	1792	6034	1dp
Loop.2.Diag.SchedR2G	The Scheduled Relative Cool Gain	float32	1799	6041	1dp
Loop.2.Diag.SchedTd	The Scheduled Derivative Time (0 = Off)	float32	1794	6036	0dp
Loop.2.Diag.SchedTi	The Scheduled Integral Time (0 = Off)	float32	1793	6035	0dp
Loop.2.Diag.TargetOutVal	Target Output	float32	028e	654	Same as Loop.2.OP.OutputHighLimit
Loop.2.Diag.WrkOPHi	Working Output Hi Limit	float32	0295	661	0dp
Loop.2.Diag.WrkOPLo	Working Output Lo Limit	float32	0294	660	0dp
Loop.2.Main.ActiveOut	Working Output	float32	0284	644	Same as Loop.2.OP.OutputHighLimit
Loop.2.Main.AutoMan	Auto/Manual Mode (0 = Auto; 1 = Man)	bool	0281	641	Not applicable
Loop.2.Main.Inhibit	Control Inhibit (0 = No; 1 = Yes)	bool	0285	645	Not applicable
Loop.2.Main.IntHold	Integral action inhibit. 0 = No; 1 = Yes	uint8	0286	646	Not applicable
Loop.2.Main.PV	Process Variable value	float32	0280	640	1dp
Loop.2.Main.TargetSP	Target Setpoint	float32	0282	642	Same as Loop.2.Main.PV
Loop.2.Main.WorkingSP	Working Setpoint	float32	0283	643	Same as Loop.2.Main.PV
Loop.2.OP.Ch1OnOffHysteresis	Channel 1 hysteresis in engineering units	float32	1772	6002	Same as Loop.2.Main.PV
Loop.2.OP.Ch1Out	Channel 1 Output Value	float32	028b	651	Same as Loop.2.OP.OutputHighLimit
Loop.2.OP.Ch1PotBreak	Ch1 Potentiometer Break (0 = Off; 1 = On)	uint8	1779	6009	Not applicable
Loop.2.OP.Ch1PotPosition	Ch1 Valve Position	float32	1778	6008	0dp
Loop.2.OP.Ch1TravelTime	Channel 1 Travel Time	float32	1774	6004	1dp
Loop.2.OP.Ch2Deadband	Channel 2 Deadband	float32	176f	5999	Same as Loop.2.OP.OutputHighLimit
Loop.2.OP.Ch2OnOffHysteresis	Channel 2 hysteresis in engineering units	float32	1773	6003	Same as Loop.2.Main.PV
Loop.2.OP.Ch2Out	Channel 2 output value	float32	028c	652	Same as Loop.2.OP.OutputHighLimit
Loop.2.OP.Ch2PotBreak	Channel 2 Potentiometer Break (0 = Off; 1 = On)	uint8	177b	6011	Not applicable
Loop.2.OP.Ch2PotPosition	Channel 2 Valve Position	float32	177a	6010	0dp
Loop.2.OP.Ch2TravelTime	Channel 2 Travel Time	float32	1775	6005	1dp
Loop.2.OP.CoolTime	Cooling Algorithm Type	uint8	1799	6040	Not applicable

Parameter path	Description	Type	Hex	Dec	Resolution
Loop.2.OP.EnablePowerFeedforward	0 = Power Feedforward disabled; 1 = PFF enabled	uint8	1781	6017	Not applicable
Loop.2.OP.FeedForwardGain	Feedforward Gain	float32	1785	6021	3dp
Loop.2.OP.FeedForwardOffset	Feedforward Offset	float32	1786	6022	0dp
Loop.2.OP.FeedForwardTrimLimit	Feedforward Trim Limit	float32	1787	6023	0dp
Loop.2.OP.FeedForwardType	Feedforward Type (0 = None; 1 = Remote; 2 = SP; 3 = PV)	uint8	1784	6020	Not applicable
Loop.2.OP.FeedForwardVal	Feedforward Value	float32	1788	6024	0dp
Loop.2.OP.FF_Rem	Remote Feed Forward Input	float32	178d	6029	0dp
Loop.2.OP.ForcedOP	Forced manual output value	float32	178f	6031	1dp
Loop.2.OP.ManStartup	Manual Startup Mode (0 = Off; 1 = On)	bool	1790	6032	Not applicable
Loop.2.OP.ManualMode	Manual Output Mode (0 = Track; 1 = Step; 2 = Last MOP)	uint8	177f	6015	Not applicable
Loop.2.OP.ManualOutVal	Manual Output Value	float32	1780	6016	Same as Loop.2.OP.OutputHighLimit
Loop.2.OP.MeasuredPower	Measured Mains Voltage	float32	1782	6018	0dp
Loop.2.OP.NudgeLower	Valve Nudge Lower (1 = Lower)	uint8	1777	6007	Not applicable
Loop.2.OP.NudgeRaise	Valve Nudge Raise (1 = Raise)	uint8	1776	6006	Not applicable
Loop.2.OP.OutputHighLimit	Output High Limit	float32	176d	5997	1dp
Loop.2.OP.OutputLowLimit	Output Low Limit	float32	176e	5998	Same as Loop.2.OP.OutputHighLimit
Loop.2.OP.PotBreakMode	Potentiometer Break Mode (0 = Raise; 1 = Lower; 2 = Rest; 3 = Model)	uint8	177c	6012	Not applicable
Loop.2.OP.Rate	Output Rate Limit Value (0 = off)	float32	1770	6000	1dp
Loop.2.OP.RateDisable	Output Rate Limit Disable (0 = No, 1 = Yes)	bool	1771	6001	Not applicable
Loop.2.OP.RemOPH	Remote Output High Limit	float32	178c	6028	Same as Loop.2.Main.ActiveOut
Loop.2.OP.RemOPL	Remote Output Low Limit	float32	178b	6027	Same as Loop.2.Main.ActiveOut
Loop.2.OP.SafeOutVal	Safe Output Value	float32	177e	6014	Same as Loop.2.OP.OutputHighLimit
Loop.2.OP.SbrkOP	The output power under sensor break conditions	float32	178e	6030	Same as Loop.2.OP.OutputHighLimit
Loop.2.OP.SensorBreakMode	Sensor Break Mode (0 = SbrkOP; 1 = Hold)	uint8	177d	6013	Not applicable
Loop.2.OP.TrackEnable	Enable Output Tracking (0 = Off; 1 = On)	uint8	178a	6026	Not applicable
Loop.2.OP.TrackOutVal	Output Track Value	float32	1789	6025	0dp
Loop.2.PID.ActiveSet	Current PID set	uint8	1738	5944	Not applicable
Loop.2.PID.Boundary1-2	Threshold for swapping between set 1 and set 2	float32	1739	5945	0dp
Loop.2.PID.Boundary2-3	Threshold for swapping between set 2 and set 3	float32	173a	5946	0dp
Loop.2.PID.CutbackHigh	Cutback high value for PID set 1 (0 = Auto)	float32	173f	5951	1dp
Loop.2.PID.CutbackHigh2	Cutback high value for PID set 2 (0 = Auto)	float32	1747	5959	1dp
Loop.2.PID.CutbackHigh3	Cutback high value for PID set 3 (0 = Auto)	float32	174f	5967	1dp
Loop.2.PID.CutbackLow	Cutback low value for PID set 1 (0 = Auto)	float32	1740	5952	1dp
Loop.2.PID.CutbackLow2	Cutback low value for PID set 2 (0 = Auto)	float32	1748	5960	1dp
Loop.2.PID.CutbackLow3	Cutback low value for PID set 3 (0 = Auto)	float32	1750	5968	1dp
Loop.2.PID.DerivativeTime	Derivative time for PID set 1	float32	173d	5949	0dp
Loop.2.PID.DerivativeTime2	Derivative time for PID set 2	float32	1745	5957	0dp
Loop.2.PID.DerivativeTime3	Derivative time for PID set 3	float32	174d	5965	0dp
Loop.2.PID.IntegralTime	Integral time for PID set 1	float32	173c	5948	0dp
Loop.2.PID.IntegralTime2	Integral time for PID set 2	float32	1744	5956	0dp
Loop.2.PID.IntegralTime3	Integral time for PID set 3	float32	174c	5964	0dp
Loop.2.PID.LoopBreakTime	Loop break time for PID set 1	float32	1742	5954	0dp
Loop.2.PID.LoopBreakTime2	Loop break time for PID set 2	float32	174a	5962	0dp
Loop.2.PID.LoopBreakTime3	Loop break time for PID set 3	float32	1752	5970	0dp
Loop.2.PID.ManualReset	Manual reset value for PID set 1	float32	1741	5953	1dp
Loop.2.PID.ManualReset2	Manual reset value for PID set 2	float32	1749	5961	1dp
Loop.2.PID.ManualReset3	Manual reset value for PID set 3	float32	1751	5969	1dp
Loop.2.PID.NumSets	Number of PID sets to be used (max. 3)	uint8	1736	5942	Not applicable
Loop.2.PID.OutputHi	Gain scheduled output high limit for PID set 1	float32	1753	5971	1dp
Loop.2.PID.OutputHi2	Gain scheduled output high limit for PID set 2	float32	1755	5973	1dp
Loop.2.PID.OutputHi3	Gain scheduled output high limit for PID set 3	float32	1757	5975	1dp
Loop.2.PID.OutputLo	Gain scheduled output low limit for PID set 1	float32	1754	5972	1dp
Loop.2.PID.OutputLo2	Gain scheduled output low limit for PID set 2	float32	1756	5974	1dp
Loop.2.PID.OutputLo3	Gain scheduled output low limit for PID set 3	float32	1758	5976	1dp
Loop.2.PID.ProportionalBand	Proportional band value for PID set 1	float32	173b	5947	1dp
Loop.2.PID.ProportionalBand2	Proportional band value for PID set 2	float32	1743	5955	1dp
Loop.2.PID.ProportionalBand3	Proportional band value for PID set 3	float32	174b	5963	1dp
Loop.2.PID.RelCh2Gain	Channel 2 relative cool gain value for PID set 1	float32	173e	5950	1dp
Loop.2.PID.RelCh2Gain2	Channel 2 relative cool gain value for PID set 2	float32	1746	5958	1dp
Loop.2.PID.RelCh2Gain3	Channel 2 relative cool gain value for PID set 3	float32	174e	5966	1dp

Parameter path	Description	Type	Hex	Dec	Resolution
Loop.2.PID.SchedulerType	Scheduler Type 0 = Off 1 = Set 2 = SP 3 = PV 4 = Error 5 = OP 6 = Rem	uint8	1735	5941	Not applicable
Loop.2.Setup.AutoManAccess	Edit access to 'Auto Man' in Loop display page 0 = Read/Write (R/W) all modes 1 = Editable in all modes except 'Logged out' 2 = Editable only at Engineer and Supervisor levels	uint8	17a8	6056	Not applicable
Loop.2.Setup.CH1ControlType	Channel 1 Control Type 0 = Off; 1 = On Off; 2 = PID; 3 = VPU; 4 = VPB	uint8	1701	5889	Not applicable
Loop.2.Setup.CH2ControlType	Channel 2 Control Type (As channel 1, above)	uint8	1702	5890	Not applicable
Loop.2.Setup.ControlAction	Control Action (0 = Reverse; 1 = Direct)	uint8	1703	5891	Not applicable
Loop.2.Setup.DerivativeType	Derivative Type (0 = PV; 1 = Error)	uint8	1705	5893	Not applicable
Loop.2.Setup.LoopName	Loop Name	string_t	5d10	23824	Not applicable
Loop.2.Setup.ManOutputAccess	Manual output access	uint8	17a9	6057	Not applicable
Loop.2.Setup.LoopType	Loop Type (0 = single; 1 = cascade; 2 = override; 3 = ratio)	uint8	1700	5888	Not applicable
Loop.2.Setup.PBUnits	Proportional Band Units (0 = Engineering units; 1 = percent)	uint8	1704	5892	Not applicable
Loop.2.Setup.SPAccess	Edit access to 'SP' in Loop display page 0 = Read/Write (R/W) all modes 1 = Editable in all modes except 'Logged out' 2 = Editable only at Engineer and Supervisor levels	uint8	17a7	6055	Not applicable
Loop.2.SP.AltSP	Alternative Setpoint	float32	1760	5984	Same as Loop.2.Main.PV
Loop.2.SP.AltSPSelect	Select alternative setpoint (0 = No; 1 = Yes)	uint8	1761	5985	Not applicable
Loop.2.SP.ManualTrack	Manual Track Enable (0 = disable; 1 = enable)	uint8	1767	5991	Not applicable
Loop.2.SP.RangeHigh	Setpoint Range High Limit	float32	1759	5977	Same as Loop.2.Main.PV
Loop.2.SP.RangeLow	Setpoint Range Low Limit	float32	175a	5978	Same as Loop.2.Main.PV
Loop.2.SP.Rate	Setpoint Rate Limit Value (0 = Rate limit off)	float32	1762	5986	Same as Loop.2.Main.PV
Loop.2.SP.RateDisable	Setpoint Rate Limit Disable (0 = No; 1 = Yes)	bool	1763	5987	Not applicable
Loop.2.SP.RateDone	Setpoint Rate Limit Complete (0 = No; 1 = Yes)	bool	028a	650	Not applicable
Loop.2.SP.ServoToPV	Servo to PV Enable (0 = No; 1 = Yes)	bool	176c	5996	Not applicable
Loop.2.SP.SP1	Setpoint 1	float32	175c	5980	Same as Loop.2.Main.PV
Loop.2.SP.SP2	Setpoint 2	float32	175d	5981	Same as Loop.2.Main.PV
Loop.2.SP.SPHighLimit	Setpoint High Limit	float32	175e	5982	Same as Loop.2.Main.PV
Loop.2.SP.SPIntBal	SP Integral Balance (0 = Off; 1 = On)	bool	176b	5995	Not applicable
Loop.2.SP.SPLowLimit	Setpoint Low Limit	float32	175f	5983	Same as Loop.2.Main.PV
Loop.2.SP.SPSelect	Active Setpoint Select (0 = SP1; 1 = SP2)	uint8	175b	5979	Not applicable
Loop.2.SP.SPTrack	Enables setpoint tracking (0 = Off; 1 = On)	uint8	1768	5992	Not applicable
Loop.2.SP.SPTrim	Setpoint Trim	float32	1764	5988	Same as Loop.2.Main.PV
Loop.2.SP.SPTrimHighLimit	Setpoint Trim High Limit	float32	1765	5989	Same as Loop.2.Main.PV
Loop.2.SP.SPTrimLowLimit	Setpoint Trim Low Limit	float32	1766	5990	Same as Loop.2.Main.PV
Loop.2.SP.TrackPV	PV for Programmer to Track	float32	1769	5993	Same as Loop.2.Main.PV
Loop.2.SP.TrackSP	Manual Tracking Value	float32	176a	5994	Same as Loop.2.Main.PV
Loop.2.Tune.Alpha	Alpha	float32	17ad	6061	4dp
Loop.2.Tune.Alpha_p	Alpha_p	float32	17ab	6059	2dp
Loop.2.Tune.AutotuneEnable	Initiate autotune (0 = Autotune Off; 1 = on)	bool	1731	5937	Not applicable
Loop.2.Tune.CycleNo	CycleNo	float32	17af	6063	0dp
Loop.2.Tune.Debug	Debug	float32	17ae	6062	2dp
Loop.2.Tune.Diagnostics	Tuning diagnostics	bool	31ce	12750	Not applicable
Loop.2.Tune.OPss	OPss	float32	17ac	6060	2dp
Loop.2.Tune.OutputHighLimit	Autotune High Output Power Limit	float32	1732	5938	Same as Loop.2.OP.OutputHighLimit
Loop.2.Tune.OutputLowLimit	Autotune Low Output Power Limit	float32	1733	5939	Same as Loop.2.OP.OutputHighLimit
Loop.2.Tune.PBs	PBs	float32	17b0	6064	2dp
Loop.2.Tune.Settle	Settle	float32	17b2	6066	2dp
Loop.2.Tune.Stage	Stage of Tune 0 = Reset 1 = None 2 = Monitor 3 = Current SP 4 = NewSP 5 = ToSp 6 = Max 7 = Min	uint8	0288	648	Not applicable
Loop.2.Tune.StageTime	Time in this Stage of Tune	float32	0289	649	0dp
Loop.2.Tune.State	Autotune state 0 = Off 1 = Ready 2 = Complete 3 = Timeout 4 = Ti Limit 5 = R2g limit	uint8	0287	647	Not applicable
Loop.2.Tune.TDs	TDs	float32	17b1	6065	2dp
Loop.2.Tune.TuneR2G	R2G Tuning Type	uint8	1608	5640	Not applicable

Parameter path	Description	Type	Hex	Dec	Resolution
	(0 = Cycle; 1 = Single; 2 = Adaptive; 3 = R2GPD)				
MassFlow.Mode	The mode of mass flow calculation	string_t	2e64	11876	Not applicable
MassFlow.Temperature	Temperature Input	float32	2e66	11878	Set by MassFlow.Resolution
MassFlow.DeltaP	DeltaP Input	float32	2e67	11879	Set by MassFlow.Resolution
MassFlow.Pressure	Pressure Input	float32	2e68	11880	Set by MassFlow.Resolution
MassFlow.ScaleInput	Scale Input	float32	2e69	11881	Set by MassFlow.Resolution
MassFlow.SquareRootFlow	Square Root Mass Flow Output	float32	2e6b	11883	Set by MassFlow.Resolution
MassFlow.Resolution	Resolution to which the outputs are displayed	float32	2e6c	11884	0dp
MassFlow.Ma	Ma Input	float32	2e6d	11885	Set by MassFlow.Resolution
MassFlow.GasConstant	Gas specific Constant Input	float32	2e6e	11886	Set by MassFlow.Resolution
MassFlow.Z	Compressibility Factor Input	float32	2e6f	11887	Set by MassFlow.Resolution
Math2.1.Fallback	Fallback strategy 0 = Clip Bad; 1 = Clip Good; 2 = Fallback Bad 3 = Fallback Good; 4 = Up scale; 5 = Down scale.	uint8	2faf	12207	Not applicable
Math2.1.FallbackVal	Fallback Value	float32	2fab	12203	Same as Math2.1.Out
Math2.1.HighLimit	Output High Limit	float32	2fac	12204	Same as Math2.1.Out
Math2.1.In1	Input 1 Value	float32	2fa7	12199	0dp
Math2.1.In1Mul	Input 1 Multiplier	float32	2fa6	12198	1dp
Math2.1.In2	Input 2 Value	float32	2fa9	12201	0dp
Math2.1.In2Mul	Input 2 Multiplier	float32	2fa8	12200	1dp
Math2.1.LowLimit	Output Low Limit	float32	2fad	12205	Same as Math2.1.Out
Math2.1.Oper	Operation 0 = Off 1 = Add 2 = Subtract 3 = Multiply 4 = Divide 5 = Abs diff 6 = Select Max 7 = Select Min 8 = Hot Swap 9 = Sample & Hold 10 = Power 11 = Square root 12 = Log 13 = Ln 14 = Exponential 15 = 10 to the X 51 = Select	uint8	2faa	12202	Not applicable
Math2.1.Out	Output Value	float32	2fae	12206	Set by Math2.1.Resolution
Math2.1.Resolution	Output Resolution	uint8	2fb2	12210	Not applicable
Math2.1.Select	Select Input 1 or Input 2	bool	2fb0	12208	Not applicable
Math2.1.Status	Status. 0 = Good (OK); 7 = Bad (Error)	uint8	2fb1	12209	Not applicable
Math2.1.Units	Output Units	string_t	6944	26948	Not applicable
Math2.2.Fallback	Fallback strategy (as Math2.1.Fallback)	uint8	2fbc	12220	Not applicable
Math2.2.FallbackVal	Fallback Value	float32	2fb8	12216	Same as Math2.2.Out
Math2.2.HighLimit	Output High Limit	float32	2fb9	12217	Same as Math2.2.Out
Math2.2.In1	Input 1 Value	float32	2fb4	12212	0dp
Math2.2.In1Mul	Input 1 Scale	float32	2fb3	12211	1dp
Math2.2.In2	Input 2 Value	float32	2fb6	12214	0dp
Math2.2.In2Mul	Input 2 Scale	float32	2fb5	12213	1dp
Math2.2.LowLimit	Output Low Limit	float32	2fba	12218	Same as Math2.2.Out
Math2.2.Oper	Operation (as Math2.1.Oper)	uint8	2fb7	12215	Not applicable
Math2.2.Out	Output Value	float32	2fbb	12219	Set by Math2.2.Resolution
Math2.2.Resolution	Output Resolution	uint8	2fbf	12223	Not applicable
Math2.2.Select	Select Input 1 or Input 2	bool	2fbd	12221	Not applicable
Math2.2.Status	Status. 0 = Good (OK); 7 = Bad (Error)	uint8	2fbe	12222	Not applicable
Math2.2.Units	Output Units	string_t	694a	26954	Not applicable
Math2.3.Fallback	Fallback strategy (as Math2.1.Fallback)	uint8	2fc9	12233	Not applicable
Math2.3.FallbackVal	Fallback Value	float32	2fc5	12229	Same as Math2.3.Out
Math2.3.HighLimit	Output High Limit	float32	2fc6	12230	Same as Math2.3.Out
Math2.3.In1	Input 1 Value	float32	2fc1	12225	0dp
Math2.3.In1Mul	Input 1 Scale	float32	2fc0	12224	1dp
Math2.3.In2	Input 2 Value	float32	2fc3	12227	0dp
Math2.3.In2Mul	Input 2 Scale	float32	2fc2	12226	1dp
Math2.3.LowLimit	Output Low Limit	float32	2fc7	12231	Same as Math2.3.Out
Math2.3.Oper	Operation (as Math2.1.Oper)	uint8	2fc4	12228	Not applicable
Math2.3.Out	Output Value	float32	2fc8	12232	Set by Math2.3.Resolution

Parameter path	Description	Type	Hex	Dec	Resolution
Math2.3.Select	Select Between Input 1 and Input 2	bool	2fca	12234	Not applicable
Math2.3.Status	Status. 0 = Good (OK); 7 = Bad (Error)	uint8	2fcb	12235	Not applicable
Math2.3.Units	Output Units	string_t	6950	26960	Not applicable
Math2.4.Fallback	Fallback strategy (as Math2.1.Fallback)	uint8	2fd6	12246	Not applicable
Math2.4.FallbackVal	Fallback Value	float32	2fd2	12242	Same as Math2.4.Out
Math2.4.HighLimit	Output High Limit	float32	2fd3	12243	Same as Math2.4.Out
Math2.4.In1	Input 1 Value	float32	2fce	12238	0dp
Math2.4.In1Mul	Input 1 Scale	float32	2fcd	12237	1dp
Math2.4.In2	Input 2 Value	float32	2fd0	12240	0dp
Math2.4.In2Mul	Input 2 Scale	float32	2fcf	12239	1dp
Math2.4.LowLimit	Output Low Limit	float32	2fd4	12244	Same as Math2.4.Out
Math2.4.Oper	Operation (as Math2.1.Oper)	uint8	2fd1	12241	Not applicable
Math2.4.Out	Output Value	float32	2fd5	12245	Set by Math2.4.Resolution
Math2.4.Resolution	Output Resolution	uint8	2fd9	12249	Not applicable
Math2.4.Select	Select Between Input 1 and Input 2	bool	2fd7	12247	Not applicable
Math2.4.Status	Status. 0 = Good (OK); 7 = Bad (Error)	uint8	2fd8	12248	Not applicable
Math2.4.Units	Output Units	string_t	6956	26966	Not applicable
Math2.5.Fallback	Fallback strategy (as Math2.1.Fallback)	uint8	2fe3	12259	Not applicable
Math2.5.FallbackVal	Fallback Value	float32	2fdf	12255	Same as Math2.5.Out
Math2.5.HighLimit	Output High Limit	float32	2fe0	12256	Same as Math2.5.Out
Math2.5.In1	Input 1 Value	float32	2fdb	12251	0dp
Math2.5.In1Mul	Input 1 Scale	float32	2fda	12250	1dp
Math2.5.In2	Input 2 Value	float32	2fdd	12253	0dp
Math2.5.In2Mul	Input 2 Scale	float32	2fdc	12252	1dp
Math2.5.LowLimit	Output Low Limit	float32	2fe1	12257	Same as Math2.5.Out
Math2.5.Oper	Operation (as Math2.1.Oper)	uint8	2fde	12254	Not applicable
Math2.5.Out	Output Value	float32	2fe2	12258	Set by Math2.5.Resolution
Math2.5.Resolution	Output Resolution	uint8	2fe6	12262	Not applicable
Math2.5.Select	Select Between Input 1 and Input 2	bool	2fe4	12260	Not applicable
Math2.5.Status	Status. 0 = Good (OK); 7 = Bad (Error)	uint8	2fe5	12261	Not applicable
Math2.5.Units	Output Units	string_t	695c	26972	Not applicable
Math2.6.Fallback	Fallback strategy (as Math2.1.Fallback)	uint8	2ff0	12272	Not applicable
Math2.6.FallbackVal	Fallback Value	float32	2fec	12268	Same as Math2.6.Out
Math2.6.HighLimit	Output High Limit	float32	2fed	12269	Same as Math2.6.Out
Math2.6.In1	Input 1 Value	float32	2fe8	12264	0dp
Math2.6.In1Mul	Input 1 Scale	float32	2fe7	12263	1dp
Math2.6.In2	Input 2 Value	float32	2fea	12266	0dp
Math2.6.In2Mul	Input 2 Scale	float32	2fe9	12265	1dp
Math2.6.LowLimit	Output Low Limit	float32	2fee	12270	Same as Math2.6.Out
Math2.6.Oper	Operation (as Math2.1.Oper)	uint8	2feb	12267	Not applicable
Math2.6.Out	Output Value	float32	2fef	12271	Set by Math2.6.Resolution
Math2.6.Resolution	Output Resolution	uint8	2ff3	12275	Not applicable
Math2.6.Select	Select Between Input 1 and Input 2	bool	2ff1	12273	Not applicable
Math2.6.Status	Status. 0 = Good (OK); 7 = Bad (Error)	uint8	2ff2	12274	Not applicable
Math2.6.Units	Output Units	string_t	6962	26978	Not applicable
Math2.7.Fallback	Fallback strategy (as Math2.1.Fallback)	uint8	2ffd	12285	Not applicable
Math2.7.FallbackVal	Fallback Value	float32	2ff9	12281	Same as Math2.7.Out
Math2.7.HighLimit	Output High Limit	float32	2ffa	12282	Same as Math2.7.Out
Math2.7.In1	Input 1 Value	float32	2ff5	12277	0dp
Math2.7.In1Mul	Input 1 Scale	float32	2ff4	12276	1dp
Math2.7.In2	Input 2 Value	float32	2ff7	12279	0dp
Math2.7.In2Mul	Input 2 Scale	float32	2ff6	12278	1dp
Math2.7.LowLimit	Output Low Limit	float32	2ffb	12283	Same as Math2.7.Out
Math2.7.Oper	Operation (as Math2.1.Oper)	uint8	2ff8	12280	Not applicable
Math2.7.Out	Output Value	float32	2ffc	12284	Set by Math2.7.Resolution
Math2.7.Resolution	Output Resolution	uint8	3000	12288	Not applicable
Math2.7.Select	Select Between Input 1 and Input 2	bool	2ffc	12288	Not applicable

Parameter path	Description	Type	Hex	Dec	Resolution
Math2.7.Units	Output Units	string_t	6968	26984	Not applicable
Math2.8.Fallback	Fallback strategy (as Math2.1.Fallback)	uint8	300a	12298	Not applicable
Math2.8.FallbackVal	Fallback Value	float32	3006	12294	Same as Math2.8.Out
Math2.8.HighLimit	Output High Limit	float32	3007	12295	Same as Math2.8.Out
Math2.8.In1	Input 1 Value	float32	3002	12290	0dp
Math2.8.In1Mul	Input 1 Scale	float32	3001	12289	1dp
Math2.8.In2	Input 2 Value	float32	3004	12292	0dp
Math2.8.In2Mul	Input 2 Scale	float32	3003	12291	1dp
Math2.8.LowLimit	Output Low Limit	float32	3008	12296	Same as Math2.8.Out
Math2.8.Oper	Operation (as Math2.1.Oper)	uint8	3005	12293	Not applicable
Math2.8.Out	Output Value	float32	3009	12297	Set by Math2.8.Resolution
Math2.8.Resolution	Output Resolution	uint8	300d	12301	Not applicable
Math2.8.Select	Select Between Input 1 and Input 2	bool	300b	12299	Not applicable
Math2.8.Status	Status. 0 = Good (OK); 7 = Bad (Error)	uint8	300c	12300	Not applicable
Math2.8.Units	Output Units	string_t	696e	26990	Not applicable
Math2.9.Fallback	Fallback strategy (as Math2.1.Fallback)	uint8	3017	12311	Not applicable
Math2.9.FallbackVal	Fallback Value	float32	3013	12307	Same as Math2.9.Out
Math2.9.HighLimit	Output High Limit	float32	3014	12308	Same as Math2.9.Out
Math2.9.In1	Input 1 Value	float32	300f	12303	0dp
Math2.9.In1Mul	Input 1 Scale	float32	300e	12302	1dp
Math2.9.In2	Input 2 Value	float32	3011	12305	0dp
Math2.9.In2Mul	Input 2 Scale	float32	3010	12304	1dp
Math2.9.LowLimit	Output Low Limit	float32	3015	12309	Same as Math2.9.Out
Math2.9.Oper	Operation (as Math2.1.Oper)	uint8	3012	12306	Not applicable
Math2.9.Out	Output Value	float32	3016	12310	Set by Math2.9.Resolution
Math2.9.Resolution	Output Resolution	uint8	301a	12314	Not applicable
Math2.9.Select	Select Between Input 1 and Input 2	bool	3018	12312	Not applicable
Math2.9.Status	Status. 0 = Good (OK); 7 = Bad (Error)	uint8	3019	12313	Not applicable
Math2.9.Units	Output Units	string_t	6974	26996	Not applicable
Math2.10.Fallback	Fallback strategy (as Math2.1.Fallback)	uint8	3024	12324	Not applicable
Math2.10.FallbackVal	Fallback Value	float32	3020	12320	Same as Math2.10.Out
Math2.10.HighLimit	Output High Limit	float32	3021	12321	Same as Math2.10.Out
Math2.10.In1	Input 1 Value	float32	301c	12316	0dp
Math2.10.In1Mul	Input 1 Scale	float32	301b	12315	1dp
Math2.10.In2	Input 2 Value	float32	301e	12318	0dp
Math2.10.In2Mul	Input 2 Scale	float32	301d	12317	1dp
Math2.10.LowLimit	Output Low Limit	float32	3022	12322	Same as Math2.10.Out
Math2.10.Oper	Operation (as Math2.1.Oper)	uint8	301f	12319	Not applicable
Math2.10.Out	Output Value	float32	3023	12323	Set by Math2.10.Resolution
Math2.10.Resolution	Output Resolution	uint8	3027	12327	Not applicable
Math2.10.Select	Select Between Input 1 and Input 2	bool	3025	12325	Not applicable
Math2.10.Status	Status. 0 = Good (OK); 7 = Bad (Error)	uint8	3026	12326	Not applicable
Math2.10.Units	Output Units	string_t	697a	27002	Not applicable
Math2.11.Fallback	Fallback strategy (as Math2.1.Fallback)	uint8	3031	12337	Not applicable
Math2.11.FallbackVal	Fallback Value	float32	302d	12333	Same as Math2.11.Out
Math2.11.HighLimit	Output High Limit	float32	302e	12334	Same as Math2.11.Out
Math2.11.In1	Input 1 Value	float32	3029	12329	0dp
Math2.11.In1Mul	Input 1 Scale	float32	3028	12328	1dp
Math2.11.In2	Input 2 Value	float32	302b	12331	0dp
Math2.11.In2Mul	Input 2 Scale	float32	302a	12330	1dp
Math2.11.LowLimit	Output Low Limit	float32	302f	12335	Same as Math2.11.Out
Math2.11.Oper	Operation (as Math2.1.Oper)	uint8	302c	12332	Not applicable
Math2.11.Out	Output Value	float32	3030	12336	Set by Math2.11.Resolution
Math2.11.Resolution	Output Resolution	uint8	3034	12340	Not applicable
Math2.11.Select	Select Between Input 1 and Input 2	bool	3032	12338	Not applicable
Math2.11.Status	Status. 0 = Good (OK); 7 = Bad (Error)	uint8	3033	12339	Not applicable
Math2.11.Units	Output Units	string_t	6980	27008	Not applicable

Parameter path	Description	Type	Hex	Dec	Resolution
Math2.12.Fallback	Fallback strategy (as Math2.1.Fallback)	uint8	303e	12350	Not applicable
Math2.12.FallbackVal	Fallback Value	float32	303a	12346	Same as Math2.12.Out
Math2.12.HighLimit	Output High Limit	float32	303b	12347	Same as Math2.12.Out
Math2.12.In1	Input 1 Value	float32	3036	12342	0dp
Math2.12.In1Mul	Input 1 Scale	float32	3035	12341	1dp
Math2.12.In2	Input 2 Value	float32	3038	12344	0dp
Math2.12.In2Mul	Input 2 Scale	float32	3037	12343	1dp
Math2.12.LowLimit	Output Low Limit	float32	303c	12348	Same as Math2.12.Out
Math2.12.Oper	Operation (as Math2.1.Oper)	uint8	3039	12345	Not applicable
Math2.12.Out	Output Value	float32	303d	12349	Set by Math2.12.Resolution
Math2.12.Resolution	Output Resolution	uint8	3041	12353	Not applicable
Math2.12.Select	Select Between Input 1 and Input 2	bool	303f	12351	Not applicable
Math2.12.Status	Status. 0 = Good (OK); 7 = Bad (Error)	uint8	3040	12352	Not applicable
Math2.12.Units	Output Units	string_t	6986	27014	Not applicable
ModbusMaster.1.Data.AlarmStatus	Alarm status (0 = No alarms; 1 = one or more alarms active)	uint8	7dbb	32187	Not applicable
ModbusMaster.1.Data.BitPosition	Bit position of the bit of interest in a 16 bit data type	uint8	7d4f	32079	Not applicable
ModbusMaster.1.Data.ChanAlarmStatus	Channel alarm status 0 = Off 1 = Active 2 = Safe Nackd 3 = Active Nackd	uint8	7ddb	32219	Not applicable
ModbusMaster.1.Data.DataType	Data type of the data being read/written 0 = Real 1 = DINT 2 = INT3 = Byte 4 = UDINT 5 = UINT 6 = UBYTE8 = Real (Swap) 9 = DINT (Swap) 10 = UDINT (Swap) 11 = BIT	uint8	7c06	31750	Not applicable
ModbusMaster.1.Data.Descriptor	Description for this data item	string_t	6687	26247	Not applicable
ModbusMaster.1.Data.Digital	Digital status (0 = Off, 1 = On)	bool	7e1b	32283	Not applicable
ModbusMaster.1.Data.FallBackValue	Fall back value to be written to the slave device	float32	7c7e	31870	2dp
ModbusMaster.1.Data.FunctionCode	The Modbus function code 1 = Read coil 2 = Read discrete 3 = Read holding 4 = Read input 5 = Write coil 6 = Write single 16 = Write multiple	uint8	7be8	31720	Not applicable
ModbusMaster.1.Data.ModbusAddress	Modbus register address of the data to be read/written	float32	7b8c	31628	0dp
ModbusMaster.1.Data.Mode	Auto Manual mode selection (0 = Auto; 1 = Manual)	uint8	7d9b	32155	Not applicable
ModbusMaster.1.Data.Number	Used for multiple instance parameters	uint8	7d13	32019	Not applicable
ModbusMaster.1.Data.ParameterList	Parameter list for a specific slave device	uint8	7cf5	31989	Not applicable
ModbusMaster.1.Data.Priority	Frequency at which the data is read/written 0 = High 1 = Medium 2 = Low 3 = Acyclic	uint8	7c24	31780	Not applicable
ModbusMaster.1.Data.PV	Process value received from slave device	float32	7b32	31538	2dp
ModbusMaster.1.Data.Scaling	Scaling in decimal places for non floating point data types	uint8	7d31	32049	Not applicable
ModbusMaster.1.Data.Send	1 = send the write value to the slave	bool	7cb9	31929	Not applicable
ModbusMaster.1.Data.Set	Sets a digital value (1 = on; 0 = off)	bool	7dfb	32251	Not applicable
ModbusMaster.1.Data.SlaveDevice	Slave device to communicate with.	uint8	7b14	31508	Not applicable
ModbusMaster.1.Data.Status	Transaction status 0 = Success 1 = Illegal function 2 = Illegal address 6 = Slave busy 8 = Parity error 9 = Bad sub 10 = Bad gateway 11 = No response 12 = Idle 13 = Pending 14 = Timeout 15 = Unknown host 16 = Connect fail 17 = No sockets 18 = Loopback fail 19 = Login fail 20 = Unknown error 22 = Write fail 23 = Master reject	uint8	7cd7	31959	Not applicable
ModbusMaster.1.Data.Value	The value to be written to the slave device	float32	7c42	31810	
ModbusMaster.2.Data.AlarmStatus	Alarm status (as for Modbus Master.1)	uint8	7dbc	32188	Not applicable
ModbusMaster.2.Data.BitPosition	Bit position of the bit of interest in a 16 bit data type	uint8	7d50	32080	Not applicable
ModbusMaster.2.Data.ChanAlarmStatus	Channel alarm status (as for Modbus Master.1)	uint8	7ddc	32220	Not applicable
ModbusMaster.2.Data.DataType	Type of data being read/written (as for Modbus Master.1)	uint8	7c07	31751	Not applicable
ModbusMaster.2.Data.Descriptor	Description for this data item	string_t	669c	26268	Not applicable
ModbusMaster.2.Data.Digital	Digital status (0 = Off, 1 = On)	bool	7e1c	32284	Not applicable
ModbusMaster.2.Data.FallBackValue	Fall back value to be written to the slave device	float32	7c80	31872	2dp
ModbusMaster.2.Data.FunctionCode	The Modbus function code (as for Modbus Master.1)	uint8	7be9	31721	Not applicable
ModbusMaster.2.Data.ModbusAddress	Modbus register address of the data to be read/written	float32	7b8e	31630	0dp
ModbusMaster.2.Data.Mode	Auto Manual mode selection (0 = Auto; 1 = Manual)	uint8	7d9c	32156	Not applicable
ModbusMaster.2.Data.Number	Used for multiple instance parameters	uint8	7d14	32020	Not applicable
ModbusMaster.2.Data.ParameterList	Parameter list for a specific slave device	uint8	7cf6	31990	Not applicable
ModbusMaster.2.Data.Priority	Read/Write frequency (as for Modbus Master.1)	uint8	7c25	31781	Not applicable
ModbusMaster.2.Data.PV	Process value received from slave device	float32	7b34	31540	2dp
ModbusMaster.2.Data.Scaling	Scaling in decimal places for non floating point data types	uint8	7d32	32050	Not applicable

Parameter path	Description	Type	Hex	Dec	Resolution
ModbusMaster.2.Data.Set	Sets a digital value (1 = on; 0 = off)	bool	7dfc	32252	Not applicable
ModbusMaster.2.Data.SlaveDevice	Slave device to communicate with.	uint8	7b15	31509	Not applicable
ModbusMaster.2.Data.Status	Transaction status (as for Modbus Master.1)	uint8	7cd8	31960	Not applicable
ModbusMaster.2.Data.Value	The value to be written to the slave device	float32	7c44	31812	2dp
ModbusMaster.3.Data.AlarmStatus	Alarm status (as for Modbus Master.1)	uint8	7dbd	32189	Not applicable
ModbusMaster.3.Data.BitPosition	Bit position of the bit of interest in a 16 bit data type	uint8	7d51	32081	Not applicable
ModbusMaster.3.Data.ChanAlarmStatus	Channel alarm status (as for Modbus Master.1)	uint8	7ddd	32221	Not applicable
ModbusMaster.3.Data.DataType	Type of data being read/written (as for Modbus Master.1)	uint8	7c08	31752	Not applicable
ModbusMaster.3.Data.Descriptor	Description for this data item	string_t	66b1	26289	Not applicable
ModbusMaster.3.Data.Digital	Digital status (0 = Off, 1 = On)	bool	7e1d	32285	Not applicable
ModbusMaster.3.Data.FallBackValue	Fall back value to be written to the slave device	float32	7c82	31874	2dp
ModbusMaster.3.Data.FunctionCode	The Modbus function code (as for Modbus Master.1)	uint8	7bea	31722	Not applicable
ModbusMaster.3.Data.ModbusAddress	Modbus register address of the data to be read/written	float32	7b90	31632	0dp
ModbusMaster.3.Data.Mode	Auto Manual mode selection (0 = Auto; 1 = Manual)	uint8	7d9d	32157	Not applicable
ModbusMaster.3.Data.Number	Used for multiple instance parameters	uint8	7d15	32021	Not applicable
ModbusMaster.3.Data.ParameterList	Parameter list for a specific slave device	uint8	7cf7	31991	Not applicable
ModbusMaster.3.Data.Priority	Read/Write frequency (as for Modbus Master.1)	uint8	7c26	31782	Not applicable
ModbusMaster.3.Data.PV	Process value received from slave device	float32	7b36	31542	2dp
ModbusMaster.3.Data.Scaling	Scaling in decimal places for non floating point data types	uint8	7d33	32051	Not applicable
ModbusMaster.3.Data.Send	1 = send the write value to the slave	bool	7cbb	31931	Not applicable
ModbusMaster.3.Data.Set	Sets a digital value (1 = on; 0 = off)	bool	7dfd	32253	Not applicable
ModbusMaster.3.Data.SlaveDevice	Slave device to communicate with.	uint8	7b16	31510	Not applicable
ModbusMaster.3.Data.Status	Transaction status (as for Modbus Master.1)	uint8	7cd9	31961	Not applicable
ModbusMaster.3.Data.Value	The value to be written to the slave device	float32	7c46	31814	2dp
ModbusMaster.4.Data.AlarmStatus	Alarm status (as for Modbus Master.1)	uint8	7dbe	32190	Not applicable
ModbusMaster.4.Data.BitPosition	Bit position of the bit of interest in a 16 bit data type	uint8	7d52	32082	Not applicable
ModbusMaster.4.Data.ChanAlarmStatus	Channel alarm status (as for Modbus Master.1)	uint8	7dde	32222	Not applicable
ModbusMaster.4.Data.DataType	Type of data being read/written (as for Modbus Master.1)	uint8	7c09	31753	Not applicable
ModbusMaster.4.Data.Descriptor	Description for this data item	string_t	66c6	26310	Not applicable
ModbusMaster.4.Data.Digital	Digital status (0 = Off, 1 = On)	bool	7e1e	32286	Not applicable
ModbusMaster.4.Data.FallBackValue	Fall back value to be written to the slave device	float32	7c84	31876	2dp
ModbusMaster.4.Data.FunctionCode	The Modbus function code (as for Modbus Master.1)	uint8	7beb	31723	Not applicable
ModbusMaster.4.Data.ModbusAddress	Modbus register address of the data to be read/written	float32	7b92	31634	0dp
ModbusMaster.4.Data.Mode	Auto Manual mode selection (0 = Auto; 1 = Manual)	uint8	7d9e	32158	Not applicable
ModbusMaster.4.Data.Number	Used for multiple instance parameters	uint8	7d16	32022	Not applicable
ModbusMaster.4.Data.ParameterList	Parameter list for a specific slave device	uint8	7cf8	31992	Not applicable
ModbusMaster.4.Data.Priority	Read/Write frequency (as for Modbus Master.1)	uint8	7c27	31783	Not applicable
ModbusMaster.4.Data.PV	Process value received from slave device	float32	7b38	31544	2dp
ModbusMaster.4.Data.Scaling	Scaling in decimal places for non floating point data types	uint8	7d34	32052	Not applicable
ModbusMaster.4.Data.Send	1 = send the write value to the slave	bool	7cbc	31932	Not applicable
ModbusMaster.4.Data.Set	Sets a digital value (1 = on; 0 = off)	bool	7dfe	32254	Not applicable
ModbusMaster.4.Data.SlaveDevice	Slave device to communicate with.	uint8	7b17	31511	Not applicable
ModbusMaster.4.Data.Status	Transaction status (as for Modbus Master.1)	uint8	7cda	31962	Not applicable
ModbusMaster.4.Data.Value	The value to be written to the slave device	float32	7c48	31816	2dp
ModbusMaster.5.Data.AlarmStatus	Alarm status (as for Modbus Master.1)	uint8	7dbf	32191	Not applicable
ModbusMaster.5.Data.BitPosition	Bit position of the bit of interest in a 16 bit data type	uint8	7d53	32083	Not applicable
ModbusMaster.5.Data.ChanAlarmStatus	Channel alarm status (as for Modbus Master.1)	uint8	7ddf	32223	Not applicable
ModbusMaster.5.Data.DataType	Type of data being read/written (as for Modbus Master.1)	uint8	7c0a	31754	Not applicable
ModbusMaster.5.Data.Descriptor	Description for this data item	string_t	66db	26331	Not applicable
ModbusMaster.5.Data.Digital	Digital status (0 = Off, 1 = On)	bool	7e1f	32287	Not applicable
ModbusMaster.5.Data.FallBackValue	Fall back value to be written into the slave device	float32	7c86	31878	2dp
ModbusMaster.5.Data.FunctionCode	The Modbus function code (as for Modbus Master.1)	uint8	7bec	31724	Not applicable
ModbusMaster.5.Data.ModbusAddress	Modbus register address of the data to be read/written	float32	7b94	31636	0dp
ModbusMaster.5.Data.Mode	Auto Manual mode selection (0 = Auto; 1 = Manual)	uint8	7d9f	32159	Not applicable
ModbusMaster.5.Data.Number	Used for multiple instance parameters	uint8	7d17	32023	Not applicable
ModbusMaster.5.Data.ParameterList	Parameter list for a specific slave device	uint8	7cf9	31993	Not applicable
ModbusMaster.5.Data.Priority	Read/Write frequency (as for Modbus Master.1)	uint8	7c28	31784	Not applicable
ModbusMaster.5.Data.PV	Process value received from slave device	float32	7b3a	31546	2dp

Parameter path	Description	Type	Hex	Dec	Resolution
ModbusMaster.5.Data.Send	1 = send the write value to the slave	bool	7cbd	31933	Not applicable
ModbusMaster.5.Data.Set	Sets a digital value (1 = on; 0 = off)	bool	7dff	32255	Not applicable
ModbusMaster.5.Data.SlaveDevice	Slave device to communicate with.	uint8	7b18	31512	Not applicable
ModbusMaster.5.Data.Status	Transaction status (as for Modbus Master.1)	uint8	7cdb	31963	Not applicable
ModbusMaster.5.Data.Value	The value to be written to the slave device	float32	7c4a	31818	2dp
ModbusMaster.6.Data.AlarmStatus	Alarm status (as for Modbus Master.1)	uint8	7dc0	32192	Not applicable
ModbusMaster.6.Data.BitPosition	Bit position of the bit of interest in a 16 bit data type	uint8	7d54	32084	Not applicable
ModbusMaster.6.Data.ChanAlarmStatus	Channel alarm status (as for Modbus Master.1)	uint8	7de0	32224	Not applicable
ModbusMaster.6.Data.DataType	Type of data being read/written (as for Modbus Master.1)	uint8	7c0b	31755	Not applicable
ModbusMaster.6.Data.Descriptor	Description for this data item	string_t	66f0	26352	Not applicable
ModbusMaster.6.Data.Digital	Digital status (0 = Off, 1 = On)	bool	7e20	32288	Not applicable
ModbusMaster.6.Data.FallBackValue	Fall back value to be written to the slave device	float32	7c88	31880	2dp
ModbusMaster.6.Data.FunctionCode	The Modbus function code (as for Modbus Master.1)	uint8	7bed	31725	Not applicable
ModbusMaster.6.Data.ModbusAddress	Modbus register address of the data to be read/written	float32	7b96	31638	0dp
ModbusMaster.6.Data.Mode	Auto Manual mode selection (0 = Auto; 1 = Manual)	uint8	7da0	32160	Not applicable
ModbusMaster.6.Data.Number	Used for multiple instance parameters	uint8	7d18	32024	Not applicable
ModbusMaster.6.Data.ParameterList	Parameter list for a specific slave device	uint8	7cfa	31994	Not applicable
ModbusMaster.6.Data.Priority	Read/Write frequency (as for Modbus Master.1)	uint8	7c29	31785	Not applicable
ModbusMaster.6.Data.PV	Process value received from slave device	float32	7b3c	31548	2dp
ModbusMaster.6.Data.Scaling	Scaling in decimal places for non floating point data types	uint8	7d36	32054	Not applicable
ModbusMaster.6.Data.Send	1 = send the write value to the slave	bool	7cbe	31934	Not applicable
ModbusMaster.6.Data.Set	Sets a digital value (1 = on; 0 = off)	bool	7e00	32256	Not applicable
ModbusMaster.6.Data.SlaveDevice	Slave device to communicate with.	uint8	7b19	31513	Not applicable
ModbusMaster.6.Data.Status	Transaction status (as for Modbus Master.1)	uint8	7cdc	31964	Not applicable
ModbusMaster.6.Data.Value	The value to be written to the slave device	float32	7c4c	31820	2dp
ModbusMaster.7.Data.AlarmStatus	Alarm status (as for Modbus Master.1)	uint8	7dc1	32193	Not applicable
ModbusMaster.7.Data.BitPosition	Bit position of the bit of interest in a 16 bit data type	uint8	7d55	32085	Not applicable
ModbusMaster.7.Data.ChanAlarmStatus	Channel alarm status (as for Modbus Master.1)	uint8	7de1	32225	Not applicable
ModbusMaster.7.Data.DataType	Type of data being read/written (as for Modbus Master.1)	uint8	7c0c	31756	Not applicable
ModbusMaster.7.Data.Descriptor	Description for this data item	string_t	6705	26373	Not applicable
ModbusMaster.7.Data.Digital	Digital status (0 = Off, 1 = On)	bool	7e21	32289	Not applicable
ModbusMaster.7.Data.FallBackValue	Fall back value to be written to the slave device	float32	7c8a	31882	2dp
ModbusMaster.7.Data.FunctionCode	The Modbus function code (as for Modbus Master.1)	uint8	7bee	31726	Not applicable
ModbusMaster.7.Data.ModbusAddress	Modbus register address of the data to be read/written	float32	7b98	31640	0dp
ModbusMaster.7.Data.Mode	Auto Manual mode selection (0 = Auto; 1 = Manual)	uint8	7da1	32161	Not applicable
ModbusMaster.7.Data.Number	Used for multiple instance parameters	uint8	7d19	32025	Not applicable
ModbusMaster.7.Data.ParameterList	Parameter list for a specific slave device	uint8	7cfa	31995	Not applicable
ModbusMaster.7.Data.Priority	Read/Write frequency (as for Modbus Master.1)	uint8	7c2a	31786	Not applicable
ModbusMaster.7.Data.PV	Process value received from slave device	float32	7b3e	31550	2dp
ModbusMaster.7.Data.Scaling	Scaling in decimal places for non floating point data types	uint8	7d37	32055	Not applicable
ModbusMaster.7.Data.Send	1 = send the write value to the slave	bool	7cbf	31935	Not applicable
ModbusMaster.7.Data.Set	Sets a digital value (1 = on; 0 = off)	bool	7e01	32257	Not applicable
ModbusMaster.7.Data.SlaveDevice	Slave device to communicate with.	uint8	7b1a	31514	Not applicable
ModbusMaster.7.Data.Status	Transaction status (as for Modbus Master.1)	uint8	7cdd	31965	Not applicable
ModbusMaster.7.Data.Value	The value to be written to the slave device	float32	7c4e	31822	2dp
ModbusMaster.8.Data.AlarmStatus	Alarm status (as for Modbus Master.1)	uint8	7dc2	32194	Not applicable
ModbusMaster.8.Data.BitPosition	Bit position of the bit of interest in a 16 bit data type	uint8	7d56	32086	Not applicable
ModbusMaster.8.Data.ChanAlarmStatus	Channel alarm status (as for Modbus Master.1)	uint8	7de2	32226	Not applicable
ModbusMaster.8.Data.DataType	Type of data being read/written (as for Modbus Master.1)	uint8	7c0d	31757	Not applicable
ModbusMaster.8.Data.Descriptor	Description for this data item	string_t	671a	26394	Not applicable
ModbusMaster.8.Data.Digital	Digital status (0 = Off, 1 = On)	bool	7e22	32290	Not applicable
ModbusMaster.8.Data.FallBackValue	Fall back value to be written to the slave device	float32	7c8c	31884	2dp
ModbusMaster.8.Data.FunctionCode	The Modbus function code (as for Modbus Master.1)	uint8	7bef	31727	Not applicable
ModbusMaster.8.Data.ModbusAddress	Modbus register address of the data to be read/written	float32	7b9a	31642	0dp
ModbusMaster.8.Data.Mode	Auto Manual mode selection (0 = Auto; 1 = Manual)	uint8	7da2	32162	Not applicable
ModbusMaster.8.Data.Number	Used for multiple instance parameters	uint8	7d1a	32026	Not applicable
ModbusMaster.8.Data.ParameterList	Parameter list for a specific slave device	uint8	7cfc	31996	Not applicable
ModbusMaster.9.Data.Priority	Read/Write frequency (as for Modbus Master.1)	uint8	7c2b	31787	Not applicable

Parameter path	Description	Type	Hex	Dec	Resolution
ModbusMaster.8.Data.Scaling	Scaling in decimal places for non floating point data types	uint8	7d38	32056	Not applicable
ModbusMaster.8.Data.Send	1 = send the write value to the slave	bool	7cc0	31936	Not applicable
ModbusMaster.8.Data.Set	Sets a digital value (1 = on; 0 = off)	bool	7e02	32258	Not applicable
ModbusMaster.8.Data.SlaveDevice	Slave device to communicate with.	uint8	7b1b	31515	Not applicable
ModbusMaster.8.Data.Status	Transaction status (as for Modbus Master.1)	uint8	7cde	31966	Not applicable
ModbusMaster.8.Data.Value	The value to be written to the slave device	float32	7c50	31824	2dp
ModbusMaster.9.Data.AlarmStatus	Alarm status (as for Modbus Master.1)	uint8	7dc3	32195	Not applicable
ModbusMaster.9.Data.BitPosition	Bit position of the bit of interest in a 16 bit data type	uint8	7d57	32087	Not applicable
ModbusMaster.9.Data.ChanAlarmStatus	Channel alarm status (as for Modbus Master.1)	uint8	7de3	32227	Not applicable
ModbusMaster.9.Data.DataType	Type of data being read/written (as for Modbus Master.1)	uint8	7c0e	31758	Not applicable
ModbusMaster.9.Data.Descriptor	Description for this data item	string_t	672f	26415	Not applicable
ModbusMaster.9.Data.Digital	Digital status (0 = Off, 1 = On)	bool	7e23	32291	Not applicable
ModbusMaster.9.Data.FallBackValue	Fall back value to be written to the slave device	float32	7c8e	31886	2dp
ModbusMaster.9.Data.FunctionCode	The Modbus function code (as for Modbus Master.1)	uint8	7bf0	31728	Not applicable
ModbusMaster.9.Data.ModbusAddress	Modbus register address of the data to be read/written	float32	7b9c	31644	0dp
ModbusMaster.9.Data.Mode	Auto Manual mode selection (0 = Auto; 1 = Manual)	uint8	7da3	32163	Not applicable
ModbusMaster.9.Data.Number	Used for multiple instance parameters	uint8	7d1b	32027	Not applicable
ModbusMaster.9.Data.ParameterList	Parameter list for a specific slave device	uint8	7cfd	31997	Not applicable
ModbusMaster.9.Data.Priority	FRead/Write frequency (as for Modbus Master.1)	uint8	7c2c	31788	Not applicable
ModbusMaster.9.Data.PV	Process value received from slave device	float32	7b42	31554	2dp
ModbusMaster.9.Data.Scaling	Scaling in decimal places for non floating point data types	uint8	7d39	32057	Not applicable
ModbusMaster.9.Data.Send	1 = send the write value to the slave	bool	7cc1	31937	Not applicable
ModbusMaster.9.Data.Set	Sets a digital value (1 = on; 0 = off)	bool	7e03	32259	Not applicable
ModbusMaster.9.Data.SlaveDevice	Slave device to communicate with.	uint8	7b1c	31516	Not applicable
ModbusMaster.9.Data.Status	Transaction status (as for Modbus Master.1)	uint8	7cdf	31967	Not applicable
ModbusMaster.9.Data.Value	The value to be written to the slave device	float32	7c52	31826	2dp
ModbusMaster.10.Data.AlarmStatus	Alarm status (as for Modbus Master.1)	uint8	7dc4	32196	Not applicable
ModbusMaster.10.Data.BitPosition	Bit position of the bit of interest in a 16 bit data type	uint8	7d58	32088	Not applicable
ModbusMaster.10.Data.ChanAlarmStatus	Channel alarm status (as for Modbus Master.1)	uint8	7de4	32228	Not applicable
ModbusMaster.10.Data.DataType	Type of data being read/written (as for Modbus Master.1)	uint8	7c0f	31759	Not applicable
ModbusMaster.10.Data.Descriptor	Description for this data item	string_t	6744	26436	Not applicable
ModbusMaster.10.Data.Digital	Digital status (0 = Off, 1 = On)	bool	7e24	32292	Not applicable
ModbusMaster.10.Data.FallBackValue	Fall back value to be written to the slave device	float32	7c90	31888	2dp
ModbusMaster.10.Data.FunctionCode	The Modbus function code (as for Modbus Master.1)	uint8	7bf1	31729	Not applicable
ModbusMaster.10.Data.ModbusAddress	Modbus register address of the data to be read/written	float32	7b9e	31646	0dp
ModbusMaster.10.Data.Mode	Auto Manual mode selection (0 = Auto; 1 = Manual)	uint8	7da4	32164	Not applicable
ModbusMaster.10.Data.Number	Used for multiple instance parameters	uint8	7d1c	32028	Not applicable
ModbusMaster.10.Data.ParameterList	Parameter list for a specific slave device	uint8	7cfe	31998	Not applicable
ModbusMaster.10.Data.Priority	Read/Write frequency (as for Modbus Master.1)	uint8	7c2d	31789	Not applicable
ModbusMaster.10.Data.PV	Process value received from slave device	float32	7b44	31556	2dp
ModbusMaster.10.Data.Scaling	Scaling in decimal places for non floating point data types	uint8	7d3a	32058	Not applicable
ModbusMaster.10.Data.Send	1 = send the write value to the slave	bool	7cc2	31938	Not applicable
ModbusMaster.10.Data.Set	Sets a digital value (1 = on; 0 = off)	bool	7e04	32260	Not applicable
ModbusMaster.10.Data.SlaveDevice	Slave device to communicate with.	uint8	7b1d	31517	Not applicable
ModbusMaster.10.Data.Status	Transaction status (as for Modbus Master.1)	uint8	7ce0	31968	Not applicable
ModbusMaster.10.Data.Value	The value to be written to the slave device	float32	7c54	31828	2dp
ModbusMaster.11.Data.AlarmStatus	Alarm status (as for Modbus Master.1)	uint8	7dc5	32197	Not applicable
ModbusMaster.11.Data.BitPosition	Bit position of the bit of interest in a 16 bit data type	uint8	7d59	32089	Not applicable
ModbusMaster.11.Data.ChanAlarmStatus	Channel alarm status (as for Modbus Master.1)	uint8	7de5	32229	Not applicable
ModbusMaster.11.Data.DataType	Type of data being read/written (as for Modbus Master.1)	uint8	7c10	31760	Not applicable
ModbusMaster.11.Data.Descriptor	Description for this data item	string_t	6759	26457	Not applicable
ModbusMaster.11.Data.Digital	Digital status (0 = Off, 1 = On)	bool	7e25	32293	Not applicable
ModbusMaster.11.Data.FallBackValue	Fall back value to be written to the slave device	float32	7c92	31890	2dp
ModbusMaster.11.Data.FunctionCode	The Modbus function code (as for Modbus Master.1)	uint8	7bf2	31730	Not applicable
ModbusMaster.11.Data.ModbusAddress	Modbus register address of the data to be read/written	float32	7bc0	31680	0dp
ModbusMaster.11.Data.Mode	Auto Manual mode selection (0 = Auto; 1 = Manual)	uint8	7da5	32165	Not applicable
ModbusMaster.11.Data.Number	Used for multiple instance parameters	uint8	7d1d	32029	Not applicable
ModbusMaster.11.Data.ParameterList	Parameter list for a specific slave device	uint8	7c00	31700	Not applicable

Parameter path	Description	Type	Hex	Dec	Resolution
ModbusMaster.11.Data.PV	Process value received from slave device	float32	7b46	31558	2dp
ModbusMaster.11.Data.Scaling	Scaling in decimal places for non floating point data types	uint8	7d3b	32059	Not applicable
ModbusMaster.11.Data.Send	1 = send the write value to the slave	bool	7cc3	31939	Not applicable
ModbusMaster.11.Data.Set	Sets a digital value (1 = on; 0 = off)	bool	7e05	32261	Not applicable
ModbusMaster.11.Data.SlaveDevice	Slave device to communicate with.	uint8	7b1e	31518	Not applicable
ModbusMaster.11.Data.Status	Transaction status (as for Modbus Master.1)	uint8	7ce1	31969	Not applicable
ModbusMaster.11.Data.Value	The value to be written to the slave device	float32	7c56	31830	2dp
ModbusMaster.12.Data.AlarmStatus	Alarm status (as for Modbus Master.1)	uint8	7dc6	32198	Not applicable
ModbusMaster.12.Data.BitPosition	Bit position of the bit of interest in a 16 bit data type	uint8	7d5a	32090	Not applicable
ModbusMaster.12.Data.ChanAlarmStatus	Channel alarm status (as for Modbus Master.1)	uint8	7de6	32230	Not applicable
ModbusMaster.12.Data.DataType	Type of data being read/written (as for Modbus Master.1)	uint8	7c11	31761	Not applicable
ModbusMaster.12.Data.Descriptor	Description for this data item	string_t	676e	26478	Not applicable
ModbusMaster.12.Data.Digital	Digital status (0 = Off, 1 = On)	bool	7e26	32294	Not applicable
ModbusMaster.12.Data.FallBackValue	Fall back value to be written to the slave device	float32	7c94	31892	2dp
ModbusMaster.12.Data.FunctionCode	The Modbus function code (as for Modbus Master.1)	uint8	7bf3	31731	Not applicable
ModbusMaster.12.Data.ModbusAddress	Modbus register address of the data to be read/written	float32	7bc2	31682	0dp
ModbusMaster.12.Data.Mode	Auto Manual mode selection (0 = Auto; 1 = Manual)	uint8	7da6	32166	Not applicable
ModbusMaster.12.Data.Number	Used for multiple instance parameters	uint8	7d1e	32030	Not applicable
ModbusMaster.12.Data.ParameterList	Parameter list for a specific slave device	uint8	7d00	32000	Not applicable
ModbusMaster.12.Data.Priority	Read/Write frequency (as for Modbus Master.1)	uint8	7c2f	31791	Not applicable
ModbusMaster.12.Data.PV	Process value received from slave device	float32	7b48	31560	2dp
ModbusMaster.12.Data.Scaling	Scaling in decimal places for non floating point data types	uint8	7d3c	32060	Not applicable
ModbusMaster.12.Data.Send	1 = send the write value to the slave	bool	7cc4	31940	Not applicable
ModbusMaster.12.Data.Set	Sets a digital value (1 = on; 0 = off)	bool	7e06	32262	Not applicable
ModbusMaster.12.Data.SlaveDevice	Slave device to communicate with.	uint8	7b1f	31519	Not applicable
ModbusMaster.12.Data.Status	Transaction status (as for Modbus Master.1)	uint8	7ce2	31970	Not applicable
ModbusMaster.12.Data.Value	The value to be written to the slave device	float32	7c58	31832	2dp
ModbusMaster.13.Data.AlarmStatus	Alarm status (as for Modbus Master.1)	uint8	7dc7	32199	Not applicable
ModbusMaster.13.Data.BitPosition	Bit position of the bit of interest in a 16 bit data type	uint8	7d5b	32091	Not applicable
ModbusMaster.13.Data.ChanAlarmStatus	Channel alarm status (as for Modbus Master.1)	uint8	7de7	32231	Not applicable
ModbusMaster.13.Data.DataType	Type of data being read/written (as for Modbus Master.1)	uint8	7c12	31762	Not applicable
ModbusMaster.13.Data.Descriptor	Description for this data item	string_t	6783	26499	Not applicable
ModbusMaster.13.Data.Digital	Digital status (0 = Off, 1 = On)	bool	7e27	32295	Not applicable
ModbusMaster.13.Data.FallBackValue	Fall back value to be written to the slave device	float32	7c96	31894	2dp
ModbusMaster.13.Data.FunctionCode	The Modbus function code (as for Modbus Master.1)	uint8	7bf4	31732	Not applicable
ModbusMaster.13.Data.ModbusAddress	Modbus register address of the data to be read/written	float32	7bc4	31684	0dp
ModbusMaster.13.Data.Mode	Auto Manual mode selection (0 = Auto; 1 = Manual)	uint8	7da7	32167	Not applicable
ModbusMaster.13.Data.Number	Used for multiple instance parameters	uint8	7d1f	32031	Not applicable
ModbusMaster.13.Data.ParameterList	Parameter list for a specific slave device	uint8	7d01	32001	Not applicable
ModbusMaster.13.Data.Priority	Read/Write frequency (as for Modbus Master.1)	uint8	7c30	31792	Not applicable
ModbusMaster.13.Data.PV	Process value received from slave device	float32	7b4a	31562	2dp
ModbusMaster.13.Data.Scaling	Scaling in decimal places for non floating point data types	uint8	7d3d	32061	Not applicable
ModbusMaster.13.Data.Send	1 = send the write value to the slave	bool	7cc5	31941	Not applicable
ModbusMaster.13.Data.Set	Sets a digital value (1 = on; 0 = off)	bool	7e07	32263	Not applicable
ModbusMaster.13.Data.SlaveDevice	Slave device to communicate with.	uint8	7b20	31520	Not applicable
ModbusMaster.13.Data.Status	Transaction status (as for Modbus Master.1)	uint8	7ce3	31971	Not applicable
ModbusMaster.13.Data.Value	The value to be written to the slave device	float32	7c5a	31834	2dp
ModbusMaster.14.Data.AlarmStatus	Alarm status (as for Modbus Master.1)	uint8	7dc8	32200	Not applicable
ModbusMaster.14.Data.BitPosition	Bit position of the bit of interest in a 16 bit data type	uint8	7d5c	32092	Not applicable
ModbusMaster.14.Data.ChanAlarmStatus	Channel alarm status (as for Modbus Master.1)	uint8	7de8	32232	Not applicable
ModbusMaster.14.Data.DataType	Type of data being read/written (as for Modbus Master.1)	uint8	7c13	31763	Not applicable
ModbusMaster.14.Data.Descriptor	Description for this data item	string_t	6798	26520	Not applicable
ModbusMaster.14.Data.Digital	Digital status (0 = Off, 1 = On)	bool	7e28	32296	Not applicable
ModbusMaster.14.Data.FallBackValue	Fall back value to be written to the slave device	float32	7c98	31896	2dp
ModbusMaster.14.Data.FunctionCode	The Modbus function code (as for Modbus Master.1)	uint8	7bf5	31733	Not applicable
ModbusMaster.14.Data.ModbusAddress	Modbus register address of the data to be read/written	float32	7bc6	31686	0dp
ModbusMaster.14.Data.Mode	Auto Manual mode selection (0 = Auto; 1 = Manual)	uint8	7da8	32168	Not applicable
ModbusMaster.14.Data.Number	Used for multiple instance parameters	uint8	7d20	32032	Not applicable

Parameter path	Description	Type	Hex	Dec	Resolution
ModbusMaster.14.Data.Priority	Read/Write frequency (as for Modbus Master.1)	uint8	7c31	31793	Not applicable
ModbusMaster.14.Data.PV	Process value received from slave device	float32	7b4c	31564	2dp
ModbusMaster.14.Data.Scaling	Scaling in decimal places for non floating point data types	uint8	7d3e	32062	Not applicable
ModbusMaster.14.Data.Send	1 = send the write value to the slave	bool	7cc6	31942	Not applicable
ModbusMaster.14.Data.Set	Sets a digital value (1 = on; 0 = off)	bool	7e08	32264	Not applicable
ModbusMaster.14.Data.SlaveDevice	Slave device to communicate with.	uint8	7b21	31521	Not applicable
ModbusMaster.14.Data.Status	Transaction status (as for Modbus Master.1)	uint8	7ce4	31972	Not applicable
ModbusMaster.14.Data.Value	The value to be written to the slave device	float32	7c5c	31836	2dp
ModbusMaster.15.Data.AlarmStatus	Alarm status (as for Modbus Master.1)	uint8	7dc9	32201	Not applicable
ModbusMaster.15.Data.BitPosition	Bit position of the bit of interest in a 16 bit data type	uint8	7d5d	32093	Not applicable
ModbusMaster.15.Data.ChanAlarmStatus	Channel alarm status (as for Modbus Master.1)	uint8	7de9	32233	Not applicable
ModbusMaster.15.Data.DataType	Type of data being read/written (as for Modbus Master.1)	uint8	7c14	31764	Not applicable
ModbusMaster.15.Data.Descriptor	Description for this data item	string_t	67ad	26541	Not applicable
ModbusMaster.15.Data.Digital	Digital status (0 = Off, 1 = On)	bool	7e29	32297	Not applicable
ModbusMaster.15.Data.FallBackValue	Fall back value to be written to the slave device	float32	7c9a	31898	2dp
ModbusMaster.15.Data.FunctionCode	The Modbus function code (as for Modbus Master.1)	uint8	7bf6	31734	Not applicable
ModbusMaster.15.Data.ModbusAddress	Modbus register address of the data to be read/written	float32	7bc8	31688	0dp
ModbusMaster.15.Data.Mode	Auto Manual mode selection (0 = Auto; 1 = Manual)	uint8	7da9	32169	Not applicable
ModbusMaster.15.Data.Number	Used for multiple instance parameters	uint8	7d21	32033	Not applicable
ModbusMaster.15.Data.ParameterList	Parameter list for a specific slave device	uint8	7d03	32003	Not applicable
ModbusMaster.15.Data.Priority	Read/Write frequency (as for Modbus Master.1)	uint8	7c32	31794	Not applicable
ModbusMaster.15.Data.PV	Process value received from slave device	float32	7b4e	31566	2dp
ModbusMaster.15.Data.Scaling	Scaling in decimal places for non floating point data types	uint8	7d3f	32063	Not applicable
ModbusMaster.15.Data.Send	1 = send the write value to the slave	bool	7cc7	31943	Not applicable
ModbusMaster.15.Data.Set	Sets a digital value (1 = on; 0 = off)	bool	7e09	32265	Not applicable
ModbusMaster.15.Data.SlaveDevice	Slave device to communicate with.	uint8	7b22	31522	Not applicable
ModbusMaster.15.Data.Status	Transaction status (as for Modbus Master.1)	uint8	7ce5	31973	Not applicable
ModbusMaster.15.Data.Value	The value to be written to the slave device	float32	7c5e	31838	2dp
ModbusMaster.16.Data.AlarmStatus	Alarm status (as for Modbus Master.1)	uint8	7dca	32202	Not applicable
ModbusMaster.16.Data.BitPosition	Bit position of the bit of interest in a 16 bit data type	uint8	7d5e	32094	Not applicable
ModbusMaster.16.Data.ChanAlarmStatus	Channel alarm status (as for Modbus Master.1)	uint8	7dea	32234	Not applicable
ModbusMaster.16.Data.DataType	Type of data being read/written (as for Modbus Master.1)	uint8	7c15	31765	Not applicable
ModbusMaster.16.Data.Descriptor	Description for this data item	string_t	67c2	26562	Not applicable
ModbusMaster.16.Data.Digital	Digital status (0 = Off, 1 = On)	bool	7e2a	32298	Not applicable
ModbusMaster.16.Data.FallBackValue	Fall back value to be written to the slave device	float32	7c9c	31900	2dp
ModbusMaster.16.Data.FunctionCode	The Modbus function code (as for Modbus Master.1)	uint8	7bf7	31735	Not applicable
ModbusMaster.16.Data.ModbusAddress	Modbus register address of the data to be read/written	float32	7bca	31690	0dp
ModbusMaster.16.Data.Mode	Auto Manual mode selection (0 = Auto; 1 = Manual)	uint8	7daa	32170	Not applicable
ModbusMaster.16.Data.Number	Used for multiple instance parameters	uint8	7d22	32034	Not applicable
ModbusMaster.16.Data.ParameterList	Parameter list for a specific slave device	uint8	7d04	32004	Not applicable
ModbusMaster.16.Data.Priority	Read/Write frequency (as for Modbus Master.1)	uint8	7c33	31795	Not applicable
ModbusMaster.16.Data.PV	Process value received from slave device	float32	7b50	31568	2dp
ModbusMaster.16.Data.Scaling	Scaling in decimal places for non floating point data types	uint8	7d40	32064	Not applicable
ModbusMaster.16.Data.Send	1 = send the write value to the slave	bool	7cc8	31944	Not applicable
ModbusMaster.16.Data.Set	Sets a digital value (1 = on; 0 = off)	bool	7e0a	32266	Not applicable
ModbusMaster.16.Data.SlaveDevice	Slave device to communicate with.	uint8	7b23	31523	Not applicable
ModbusMaster.16.Data.Status	Transaction status (as for Modbus Master.1)	uint8	7ce6	31974	Not applicable
ModbusMaster.16.Data.Value	The value to be written to the slave device	float32	7c60	31840	2dp
ModbusMaster.17.Data.AlarmStatus	Alarm status (as for Modbus Master.1)	uint8	7dcb	32203	Not applicable
ModbusMaster.17.Data.BitPosition	Bit position of the bit of interest in a 16 bit data type	uint8	7d5f	32095	Not applicable
ModbusMaster.17.Data.ChanAlarmStatus	Channel alarm status (as for Modbus Master.1)	uint8	7deb	32235	Not applicable
ModbusMaster.17.Data.DataType	Type of data being read/written (as for Modbus Master.1)	uint8	7c16	31766	Not applicable
ModbusMaster.17.Data.Descriptor	Description for this data item	string_t	67d7	26583	Not applicable
ModbusMaster.17.Data.Digital	Digital status (0 = Off, 1 = On)	bool	7e2b	32299	Not applicable
ModbusMaster.17.Data.FallBackValue	Fall back value to be written to the slave device	float32	7c9e	31902	2dp
ModbusMaster.17.Data.FunctionCode	The Modbus function code (as for Modbus Master.1)	uint8	7bf8	31736	Not applicable
ModbusMaster.17.Data.ModbusAddress	Modbus register address of the data to be read/written	float32	7bcc	31692	0dp
ModbusMaster.17.Data.Mode	Auto Manual mode selection (0 = Auto; 1 = Manual)	uint8	7dab	32171	Not applicable

Parameter path	Description	Type	Hex	Dec	Resolution
ModbusMaster.17.Data.ParameterList	Parameter list for a specific slave device	uint8	7d05	32005	Not applicable
ModbusMaster.17.Data.Priority	Read/Write frequency (as for Modbus Master.1)	uint8	7c34	31796	Not applicable
ModbusMaster.17.Data.PV	Process value received from slave device	float32	7b52	31570	2dp
ModbusMaster.17.Data.Scaling	Scaling in decimal places for non floating point data types	uint8	7d41	32065	Not applicable
ModbusMaster.17.Data.Send	1 = send the write value to the slave	bool	7cc9	31945	Not applicable
ModbusMaster.17.Data.Set	Sets a digital value (1 = on; 0 = off)	bool	7e0b	32267	Not applicable
ModbusMaster.17.Data.SlaveDevice	Slave device to communicate with.	uint8	7b24	31524	Not applicable
ModbusMaster.17.Data.Status	Transaction status (as for Modbus Master.1)	uint8	7ce7	31975	Not applicable
ModbusMaster.17.Data.Value	The value to be written to the slave device	float32	7c62	31842	2dp
ModbusMaster.18.Data.AlarmStatus	Alarm status (as for Modbus Master.1)	uint8	7dcc	32204	Not applicable
ModbusMaster.18.Data.BitPosition	Bit position of the bit of interest in a 16 bit data type	uint8	7d60	32096	Not applicable
ModbusMaster.18.Data.ChanAlarmStatus	Channel alarm status (as for Modbus Master.1)	uint8	7dec	32236	Not applicable
ModbusMaster.18.Data.DataType	Type of data being read/written (as for Modbus Master.1)	uint8	7c17	31767	Not applicable
ModbusMaster.18.Data.Descriptor	Description for this data item	string_t	67ec	26604	Not applicable
ModbusMaster.18.Data.Digital	Digital status (0 = Off, 1 = On)	bool	7e2c	32300	Not applicable
ModbusMaster.18.Data.FallBackValue	Fall back value to be written to the slave device	float32	7ca0	31904	2dp
ModbusMaster.18.Data.FunctionCode	The Modbus function code (as for Modbus Master.1)	uint8	7bf9	31737	Not applicable
ModbusMaster.18.Data.ModbusAddress	Modbus register address of the data to be read/written	float32	7bce	31694	0dp
ModbusMaster.18.Data.Mode	Auto Manual mode selection (0 = Auto; 1 = Manual)	uint8	7dac	32172	Not applicable
ModbusMaster.18.Data.Number	Used for multiple instance parameters	uint8	7d24	32036	Not applicable
ModbusMaster.18.Data.ParameterList	Parameter list for a specific slave device	uint8	7d06	32006	Not applicable
ModbusMaster.18.Data.Priority	FRead/Write frequency (as for Modbus Master.1)	uint8	7c35	31797	Not applicable
ModbusMaster.18.Data.PV	Process value received from slave device	float32	7b54	31572	2dp
ModbusMaster.18.Data.Scaling	Scaling in decimal places for non floating point data types	uint8	7d42	32066	Not applicable
ModbusMaster.18.Data.Send	1 = send the write value to the slave	bool	7cca	31946	Not applicable
ModbusMaster.18.Data.Set	Sets a digital value (1 = on; 0 = off)	bool	7e0c	32268	Not applicable
ModbusMaster.18.Data.SlaveDevice	Slave device to communicate with.	uint8	7b25	31525	Not applicable
ModbusMaster.18.Data.Status	Transaction status (as for Modbus Master.1)	uint8	7ce8	31976	Not applicable
ModbusMaster.18.Data.Value	The value to be written to the slave device	float32	7c64	31844	2dp
ModbusMaster.19.Data.AlarmStatus	Alarm status (as for Modbus Master.1)	uint8	7dcd	32205	Not applicable
ModbusMaster.19.Data.BitPosition	Bit position of the bit of interest in a 16 bit data type	uint8	7d61	32097	Not applicable
ModbusMaster.19.Data.ChanAlarmStatus	Channel alarm status (as for Modbus Master.1)	uint8	7ded	32237	Not applicable
ModbusMaster.19.Data.DataType	Type of data being read/written (as for Modbus Master.1)	uint8	7c18	31768	Not applicable
ModbusMaster.19.Data.Descriptor	Description for this data item	string_t	6801	26625	Not applicable
ModbusMaster.19.Data.Digital	Digital status (0 = Off, 1 = On)	bool	7e2d	32301	Not applicable
ModbusMaster.19.Data.FallBackValue	Fall back value to be written to the slave device	float32	7ca2	31906	2dp
ModbusMaster.19.Data.FunctionCode	The Modbus function code (as for Modbus Master.1)	uint8	7bfa	31738	Not applicable
ModbusMaster.19.Data.ModbusAddress	Modbus register address of the data to be read/written	float32	7bd0	31696	0dp
ModbusMaster.19.Data.Mode	Auto Manual mode selection (0 = Auto; 1 = Manual)	uint8	7dad	32173	Not applicable
ModbusMaster.19.Data.Number	Used for multiple instance parameters	uint8	7d25	32037	Not applicable
ModbusMaster.19.Data.ParameterList	Parameter list for a specific slave device	uint8	7d07	32007	Not applicable
ModbusMaster.19.Data.Priority	Read/Write frequency (as for Modbus Master.1)	uint8	7c36	31798	Not applicable
ModbusMaster.19.Data.PV	Process value received from slave device	float32	7b56	31574	2dp
ModbusMaster.19.Data.Scaling	Scaling in decimal places for non floating point data types	uint8	7d43	32067	Not applicable
ModbusMaster.19.Data.Send	1 = send the write value to the slave	bool	7ccb	31947	Not applicable
ModbusMaster.19.Data.Set	Sets a digital value (1 = on; 0 = off)	bool	7e0d	32269	Not applicable
ModbusMaster.19.Data.SlaveDevice	Slave device to communicate with.	uint8	7b26	31526	Not applicable
ModbusMaster.19.Data.Status	Transaction status (as for Modbus Master.1)	uint8	7ce9	31977	Not applicable
ModbusMaster.19.Data.Value	The value to be written to the slave device	float32	7c66	31846	2dp
ModbusMaster.20.Data.AlarmStatus	Alarm status (as for Modbus Master.1)	uint8	7dce	32206	Not applicable
ModbusMaster.20.Data.BitPosition	Bit position of the bit of interest in a 16 bit data type	uint8	7d62	32098	Not applicable
ModbusMaster.20.Data.ChanAlarmStatus	Channel alarm status (as for Modbus Master.1)	uint8	7dee	32238	Not applicable
ModbusMaster.20.Data.DataType	Type of data being read/written (as for Modbus Master.1)	uint8	7c19	31769	Not applicable
ModbusMaster.20.Data.Descriptor	Description for this data item	string_t	6816	26646	Not applicable
ModbusMaster.20.Data.Digital	Digital status (0 = Off, 1 = On)	bool	7e2e	32302	Not applicable
ModbusMaster.20.Data.FallBackValue	Fall back value to be written to the slave device	float32	7ca4	31908	2dp
ModbusMaster.20.Data.FunctionCode	The Modbus function code (as for Modbus Master.1)	uint8	7bfb	31739	Not applicable
ModbusMaster.20.Data.ModbusAddress	Modbus register address of the data to be read/written	float32	7bd2	31698	0dp

Parameter path	Description	Type	Hex	Dec	Resolution
ModbusMaster.20.Data.Number	Used for multiple instance parameters	uint8	7d26	32038	Not applicable
ModbusMaster.20.Data.ParameterList	Parameter list for a specific slave device	uint8	7d08	32008	Not applicable
ModbusMaster.20.Data.Priority	Read/Write frequency (as for Modbus Master.1)	uint8	7c37	31799	Not applicable
ModbusMaster.20.Data.PV	Process value received from slave device	float32	7b58	31576	2dp
ModbusMaster.20.Data.Scaling	Scaling in decimal places for non floating point data types	uint8	7d44	32068	Not applicable
ModbusMaster.20.Data.Send	1 = send the write value to the slave	bool	7ccc	31948	Not applicable
ModbusMaster.20.Data.Set	Sets a digital value (1 = on; 0 = off)	bool	7e0e	32270	Not applicable
ModbusMaster.20.Data.SlaveDevice	Slave device to communicate with.	uint8	7b27	31527	Not applicable
ModbusMaster.20.Data.Status	Transaction status (as for Modbus Master.1)	uint8	7cea	31978	Not applicable
ModbusMaster.20.Data.Value	The value to be written to the slave device	float32	7c68	31848	2dp
ModbusMaster.21.Data.AlarmStatus	Alarm status (as for Modbus Master.1)	uint8	7dcf	32207	Not applicable
ModbusMaster.21.Data.BitPosition	Bit position of the bit of interest in a 16 bit data type	uint8	7d63	32099	Not applicable
ModbusMaster.21.Data.ChanAlarmStatus	Channel alarm status (as for Modbus Master.1)	uint8	7def	32239	Not applicable
ModbusMaster.21.Data.DataType	Type of data being read/written (as for Modbus Master.1)	uint8	7c1a	31770	Not applicable
ModbusMaster.21.Data.Descriptor	Description for this data item	string_t	682b	26667	Not applicable
ModbusMaster.21.Data.Digital	Digital status (0 = Off, 1 = On)	bool	7e2f	32303	Not applicable
ModbusMaster.21.Data.FallBackValue	Fall back value to be written to the slave device	float32	7ca6	31910	2dp
ModbusMaster.21.Data.FunctionCode	The Modbus function code (as for Modbus Master.1)	uint8	7bfc	31740	Not applicable
ModbusMaster.21.Data.ModbusAddress	Modbus register address of the data to be read/written	float32	7bd4	31700	0dp
ModbusMaster.21.Data.Mode	Auto Manual mode selection (0 = Auto; 1 = Manual)	uint8	7daf	32175	Not applicable
ModbusMaster.21.Data.Number	Used for multiple instance parameters	uint8	7d27	32039	Not applicable
ModbusMaster.21.Data.ParameterList	Parameter list for a specific slave device	uint8	7d09	32009	Not applicable
ModbusMaster.21.Data.Priority	Read/Write frequency (as for Modbus Master.1)	uint8	7c38	31800	Not applicable
ModbusMaster.21.Data.PV	Process value received from slave device	float32	7b5a	31578	2dp
ModbusMaster.21.Data.Scaling	Scaling in decimal places for non floating point data types	uint8	7d45	32069	Not applicable
ModbusMaster.21.Data.Send	1 = send the write value to the slave	bool	7ccd	31949	Not applicable
ModbusMaster.21.Data.Set	Sets a digital value (1 = on; 0 = off)	bool	7e0f	32271	Not applicable
ModbusMaster.21.Data.SlaveDevice	Slave device to communicate with.	uint8	7b28	31528	Not applicable
ModbusMaster.21.Data.Status	Transaction status (as for Modbus Master.1)	uint8	7ceb	31979	Not applicable
ModbusMaster.21.Data.Value	The value to be written to the slave device	float32	7c6a	31850	2dp
ModbusMaster.22.Data.AlarmStatus	Alarm status (as for Modbus Master.1)	uint8	7dd0	32208	Not applicable
ModbusMaster.22.Data.BitPosition	Bit position of the bit of interest in a 16 bit data type	uint8	7d64	32100	Not applicable
ModbusMaster.22.Data.ChanAlarmStatus	Channel alarm status (as for Modbus Master.1)	uint8	7df0	32240	Not applicable
ModbusMaster.22.Data.DataType	Type of data being read/written (as for Modbus Master.1)	uint8	7c1b	31771	Not applicable
ModbusMaster.22.Data.Descriptor	Description for this data item	string_t	6840	26688	Not applicable
ModbusMaster.22.Data.Digital	Digital status (0 = Off, 1 = On)	bool	7e30	32304	Not applicable
ModbusMaster.22.Data.FallBackValue	Fall back value to be written to the slave device	float32	7ca8	31912	2dp
ModbusMaster.22.Data.FunctionCode	The Modbus function code (as for Modbus Master.1)	uint8	7bfd	31741	Not applicable
ModbusMaster.22.Data.ModbusAddress	Modbus register address of the data to be read/written	float32	7bd6	31702	0dp
ModbusMaster.22.Data.Mode	Auto Manual mode selection (0 = Auto; 1 = Manual)	uint8	7db0	32176	Not applicable
ModbusMaster.22.Data.Number	Used for multiple instance parameters	uint8	7d28	32040	Not applicable
ModbusMaster.22.Data.ParameterList	Parameter list for a specific slave device	uint8	7d0a	32010	Not applicable
ModbusMaster.22.Data.Priority	Read/Write frequency (as for Modbus Master.1)	uint8	7c39	31801	Not applicable
ModbusMaster.22.Data.PV	Process value received from slave device	float32	7b5c	31580	2dp
ModbusMaster.22.Data.Scaling	Scaling in decimal places for non floating point data types	uint8	7d46	32070	Not applicable
ModbusMaster.22.Data.Send	1 = send the write value to the slave	bool	7cce	31950	Not applicable
ModbusMaster.22.Data.Set	Sets a digital value (1 = on; 0 = off)	bool	7e10	32272	Not applicable
ModbusMaster.22.Data.SlaveDevice	Slave device to communicate with.	uint8	7b29	31529	Not applicable
ModbusMaster.22.Data.Status	Transaction status (as for Modbus Master.1)	uint8	7cec	31980	Not applicable
ModbusMaster.22.Data.Value	The value to be written to the slave device	float32	7c6c	31852	2dp
ModbusMaster.23.Data.AlarmStatus	Alarm status (as for Modbus Master.1)	uint8	7dd1	32209	Not applicable
ModbusMaster.23.Data.BitPosition	Bit position of the bit of interest in a 16 bit data type	uint8	7d65	32101	Not applicable
ModbusMaster.23.Data.ChanAlarmStatus	Channel alarm status (as for Modbus Master.1)	uint8	7df1	32241	Not applicable
ModbusMaster.23.Data.DataType	Type of data being read/written (as for Modbus Master.1)	uint8	7c1c	31772	Not applicable
ModbusMaster.23.Data.Descriptor	Description for this data item	string_t	6855	26709	Not applicable
ModbusMaster.23.Data.Digital	Digital status (0 = Off, 1 = On)	bool	7e31	32305	Not applicable
ModbusMaster.23.Data.FallBackValue	Fall back value to be written to the slave device	float32	7caa	31914	2dp
ModbusMaster.23.Data.FunctionCode	The Modbus function code (as for Modbus Master.1)	uint8	7bfe	31742	Not applicable

Parameter path	Description	Type	Hex	Dec	Resolution
ModbusMaster.23.Data.Mode	Auto Manual mode selection (0 = Auto; 1 = Manual)	uint8	7db1	32177	Not applicable
ModbusMaster.23.Data.Number	Used for multiple instance parameters	uint8	7d29	32041	Not applicable
ModbusMaster.23.Data.ParameterList	Parameter list for a specific slave device	uint8	7d0b	32011	Not applicable
ModbusMaster.23.Data.Priority	Read/Write frequency (as for Modbus Master.1)	uint8	7c3a	31802	Not applicable
ModbusMaster.23.Data.PV	Process value received from slave device	float32	7b5e	31582	2dp
ModbusMaster.23.Data.Scaling	Scaling in decimal places for non floating point data types	uint8	7d47	32071	Not applicable
ModbusMaster.23.Data.Send	1 = send the write value to the slave	bool	7ccf	31951	Not applicable
ModbusMaster.23.Data.Set	Sets a digital value (1 = on; 0 = off)	bool	7e11	32273	Not applicable
ModbusMaster.23.Data.SlaveDevice	Slave device to communicate with.	uint8	7b2a	31530	Not applicable
ModbusMaster.23.Data.Status	Transaction status (as for Modbus Master.1)	uint8	7ced	31981	Not applicable
ModbusMaster.23.Data.Value	The value to be written to the slave device	float32	7c6e	31854	2dp
ModbusMaster.24.Data.AlarmStatus	Alarm status (as for Modbus Master.1)	uint8	7dd2	32210	Not applicable
ModbusMaster.24.Data.BitPosition	Bit position of the bit of interest in a 16 bit data type	uint8	7d66	32102	Not applicable
ModbusMaster.24.Data.ChanAlarmStatus	Channel alarm status (as for Modbus Master.1)	uint8	7df2	32242	Not applicable
ModbusMaster.24.Data.DataType	Type of data being read/written (as for Modbus Master.1)	uint8	7c1d	31773	Not applicable
ModbusMaster.24.Data.Descriptor	Description for this data item	string_t	686a	26730	Not applicable
ModbusMaster.24.Data.Digital	Digital status (0 = Off, 1 = On)	bool	7e32	32306	Not applicable
ModbusMaster.24.Data.FallBackValue	Fall back value to be written to the slave device	float32	7cac	31916	2dp
ModbusMaster.24.Data.FunctionCode	The Modbus function code (as for Modbus Master.1)	uint8	7bff	31743	Not applicable
ModbusMaster.24.Data.ModbusAddress	Modbus register address of the data to be read/written	float32	7bda	31706	0dp
ModbusMaster.24.Data.Mode	Auto Manual mode selection (0 = Auto; 1 = Manual)	uint8	7db2	32178	Not applicable
ModbusMaster.24.Data.Number	Used for multiple instance parameters	uint8	7d2a	32042	Not applicable
ModbusMaster.24.Data.ParameterList	Parameter list for a specific slave device	uint8	7d0c	32012	Not applicable
ModbusMaster.24.Data.Priority	Read/Write frequency (as for Modbus Master.1)	uint8	7c3b	31803	Not applicable
ModbusMaster.24.Data.PV	Process value received from slave device	float32	7b60	31584	2dp
ModbusMaster.24.Data.Scaling	Scaling in decimal places for non floating point data types	uint8	7d48	32072	Not applicable
ModbusMaster.24.Data.Send	1 = send the write value to the slave	bool	7cd0	31952	Not applicable
ModbusMaster.24.Data.Set	Sets a digital value (1 = on; 0 = off)	bool	7e12	32274	Not applicable
ModbusMaster.24.Data.SlaveDevice	Slave device to communicate with.	uint8	7b2b	31531	Not applicable
ModbusMaster.24.Data.Status	Transaction status (as for Modbus Master.1)	uint8	7cee	31982	Not applicable
ModbusMaster.24.Data.Value	The value to be written to the slave device	float32	7c70	31856	2dp
ModbusMaster.25.Data.AlarmStatus	Alarm status (as for Modbus Master.1)	uint8	7dd3	32211	Not applicable
ModbusMaster.25.Data.BitPosition	Bit position of the bit of interest in a 16 bit data type	uint8	7d67	32103	Not applicable
ModbusMaster.25.Data.ChanAlarmStatus	Channel alarm status (as for Modbus Master.1)	uint8	7df3	32243	Not applicable
ModbusMaster.25.Data.DataType	Type of data being read/written (as for Modbus Master.1)	uint8	7c1e	31774	Not applicable
ModbusMaster.25.Data.Descriptor	Description for this data item	string_t	687f	26751	Not applicable
ModbusMaster.25.Data.Digital	Digital status (0 = Off, 1 = On)	bool	7e33	32307	Not applicable
ModbusMaster.25.Data.FallBackValue	Fall back value to be written to the slave device	float32	7cae	31918	2dp
ModbusMaster.25.Data.FunctionCode	The Modbus function code (as for Modbus Master.1)	uint8	7c00	31744	Not applicable
ModbusMaster.25.Data.ModbusAddress	Modbus register address of the data to be read/written	float32	7bdc	31708	0dp
ModbusMaster.25.Data.Mode	Auto Manual mode selection (0 = Auto; 1 = Manual)	uint8	7db3	32179	Not applicable
ModbusMaster.25.Data.Number	Used for multiple instance parameters	uint8	7d2b	32043	Not applicable
ModbusMaster.25.Data.ParameterList	Parameter list for a specific slave device	uint8	7d0d	32013	Not applicable
ModbusMaster.25.Data.Priority	Read/Write frequency (as for Modbus Master.1)	uint8	7c3c	31804	Not applicable
ModbusMaster.25.Data.PV	Process value received from slave device	float32	7b62	31586	2dp
ModbusMaster.25.Data.Scaling	Scaling in decimal places for non floating point data types	uint8	7d49	32073	Not applicable
ModbusMaster.25.Data.Send	1 = send the write value to the slave	bool	7cd1	31953	Not applicable
ModbusMaster.25.Data.Set	Sets a digital value (1 = on; 0 = off)	bool	7e13	32275	Not applicable
ModbusMaster.25.Data.SlaveDevice	Slave device to communicate with.	uint8	7b2c	31532	Not applicable
ModbusMaster.25.Data.Status	Transaction status (as for Modbus Master.1)	uint8	7cef	31983	Not applicable
ModbusMaster.25.Data.Value	The value to be written to the slave device	float32	7c72	31858	2dp
ModbusMaster.26.Data.AlarmStatus	Alarm status (as for Modbus Master.1)	uint8	7dd4	32212	Not applicable
ModbusMaster.26.Data.BitPosition	Bit position of the bit of interest in a 16 bit data type	uint8	7d68	32104	Not applicable
ModbusMaster.26.Data.ChanAlarmStatus	Channel alarm status (as for Modbus Master.1)	uint8	7df4	32244	Not applicable
ModbusMaster.26.Data.DataType	Type of data being read/written (as for Modbus Master.1)	uint8	7c1f	31775	Not applicable
ModbusMaster.26.Data.Descriptor	Description for this data item	string_t	6894	26772	Not applicable
ModbusMaster.26.Data.Digital	Digital status (0 = Off, 1 = On)	bool	7e34	32308	Not applicable
ModbusMaster.26.Data.FallBackValue	Fall back value to be written to the slave device	float32	7cb0	31920	2dp
ModbusMaster.26.Data.FunctionCode	The Modbus function code (as for Modbus Master.1)	uint8	7c01	31745	Not applicable

Parameter path	Description	Type	Hex	Dec	Resolution
ModbusMaster.26.Data.Mode	Auto Manual mode selection (0 = Auto; 1 = Manual)	uint8	7db4	32180	Not applicable
ModbusMaster.26.Data.Number	Used for multiple instance parameters	uint8	7d2c	32044	Not applicable
ModbusMaster.26.Data.ParameterList	Parameter list for a specific slave device	uint8	7d0e	32014	Not applicable
ModbusMaster.26.Data.Priority	Read/Write frequency (as for Modbus Master.1)	uint8	7c3d	31805	Not applicable
ModbusMaster.26.Data.PV	Process value received from slave device	float32	7b64	31588	2dp
ModbusMaster.26.Data.Scaling	Scaling in decimal places for non floating point data types	uint8	7d4a	32074	Not applicable
ModbusMaster.26.Data.Send	1 = send the write value to the slave	bool	7cd2	31954	Not applicable
ModbusMaster.26.Data.Set	Sets a digital value (1 = on; 0 = off)	bool	7e14	32276	Not applicable
ModbusMaster.26.Data.SlaveDevice	Slave device to communicate with.	uint8	7b2d	31533	Not applicable
ModbusMaster.26.Data.Status	Transaction status (as for Modbus Master.1)	uint8	7cf0	31984	Not applicable
ModbusMaster.26.Data.Value	The value to be written to the slave device	float32	7c74	31860	2dp
ModbusMaster.27.Data.AlarmStatus	Alarm status (as for Modbus Master.1)	uint8	7dd5	32213	Not applicable
ModbusMaster.27.Data.BitPosition	Bit position of the bit of interest in a 16 bit data type	uint8	7d69	32105	Not applicable
ModbusMaster.27.Data.ChanAlarmStatus	Channel alarm status (as for Modbus Master.1)	uint8	7df5	32245	Not applicable
ModbusMaster.27.Data.DataType	Type of data being read/written (as for Modbus Master.1)	uint8	7c20	31776	Not applicable
ModbusMaster.27.Data.Descriptor	Description for this data item	string_t	68a9	26793	Not applicable
ModbusMaster.27.Data.Digital	Digital status (0 = Off, 1 = On)	bool	7e35	32309	Not applicable
ModbusMaster.27.Data.FallBackValue	Fall back value to be written to the slave device	float32	7cb2	31922	2dp
ModbusMaster.27.Data.FunctionCode	The Modbus function code (as for Modbus Master.1)	uint8	7c02	31746	Not applicable
ModbusMaster.27.Data.ModbusAddress	Modbus register address of the data to be read/written	float32	7be0	31712	0dp
ModbusMaster.27.Data.Mode	Auto Manual mode selection (0 = Auto; 1 = Manual)	uint8	7db5	32181	Not applicable
ModbusMaster.27.Data.Number	Used for multiple instance parameters	uint8	7d2d	32045	Not applicable
ModbusMaster.27.Data.ParameterList	Parameter list for a specific slave device	uint8	7d0f	32015	Not applicable
ModbusMaster.27.Data.Priority	Read/Write frequency (as for Modbus Master.1)	uint8	7c3e	31806	Not applicable
ModbusMaster.27.Data.PV	Process value received from slave device	float32	7b66	31590	2dp
ModbusMaster.27.Data.Scaling	Scaling in decimal places for non floating point data types	uint8	7d4b	32075	Not applicable
ModbusMaster.27.Data.Send	1 = send the write value to the slave	bool	7cd3	31955	Not applicable
ModbusMaster.27.Data.Set	Sets a digital value (1 = on; 0 = off)	bool	7e15	32277	Not applicable
ModbusMaster.27.Data.SlaveDevice	Slave device to communicate with.	uint8	7b2e	31534	Not applicable
ModbusMaster.27.Data.Status	Transaction status (as for Modbus Master.1)	uint8	7cf1	31985	Not applicable
ModbusMaster.27.Data.Value	The value to be written to the slave device	float32	7c76	31862	2dp
ModbusMaster.28.Data.AlarmStatus	Alarm status (as for Modbus Master.1)	uint8	7dd6	32214	Not applicable
ModbusMaster.28.Data.BitPosition	Bit position of the bit of interest in a 16 bit data type	uint8	7d6a	32106	Not applicable
ModbusMaster.28.Data.ChanAlarmStatus	Channel alarm status (as for Modbus Master.1)	uint8	7df6	32246	Not applicable
ModbusMaster.28.Data.DataType	Type of data being read/written (as for Modbus Master.1)	uint8	7c21	31777	Not applicable
ModbusMaster.28.Data.Descriptor	Description for this data item	string_t	68be	26814	Not applicable
ModbusMaster.28.Data.Digital	Digital status (0 = Off, 1 = On)	bool	7e36	32310	Not applicable
ModbusMaster.28.Data.FallBackValue	Fall back value to be written to the slave device	float32	7cb4	31924	2dp
ModbusMaster.28.Data.FunctionCode	The Modbus function code (as for Modbus Master.1)	uint8	7c03	31747	Not applicable
ModbusMaster.28.Data.ModbusAddress	Modbus register address of the data to be read/written	float32	7be2	31714	0dp
ModbusMaster.28.Data.Mode	Auto Manual mode selection (0 = Auto; 1 = Manual)	uint8	7db6	32182	Not applicable
ModbusMaster.28.Data.Number	Used for multiple instance parameters	uint8	7d2e	32046	Not applicable
ModbusMaster.28.Data.ParameterList	Parameter list for a specific slave device	uint8	7d10	32016	Not applicable
ModbusMaster.28.Data.Priority	Read/Write frequency (as for Modbus Master.1)	uint8	7c3f	31807	Not applicable
ModbusMaster.28.Data.PV	Process value received from slave device	float32	7b68	31592	2dp
ModbusMaster.28.Data.Scaling	Scaling in decimal places for non floating point data types	uint8	7d4c	32076	Not applicable
ModbusMaster.28.Data.Send	1 = send the write value to the slave	bool	7cd4	31956	Not applicable
ModbusMaster.28.Data.Set	Sets a digital value (1 = on; 0 = off)	bool	7e16	32278	Not applicable
ModbusMaster.28.Data.SlaveDevice	Slave device to communicate with.	uint8	7b2f	31535	Not applicable
ModbusMaster.28.Data.Status	Transaction status (as for Modbus Master.1)	uint8	7cf2	31986	Not applicable
ModbusMaster.28.Data.Value	The value to be written to the slave device	float32	7c78	31864	2dp
ModbusMaster.29.Data.AlarmStatus	Alarm status (as for Modbus Master.1)	uint8	7dd7	32215	Not applicable
ModbusMaster.29.Data.BitPosition	Bit position of the bit of interest in a 16 bit data type	uint8	7d6b	32107	Not applicable
ModbusMaster.29.Data.ChanAlarmStatus	Channel alarm status (as for Modbus Master.1)	uint8	7df7	32247	Not applicable
ModbusMaster.29.Data.DataType	Type of data being read/written (as for Modbus Master.1)	uint8	7c22	31778	Not applicable
ModbusMaster.29.Data.Descriptor	Description for this data item	string_t	70ff	28927	Not applicable
ModbusMaster.29.Data.Digital	Digital status (0 = Off, 1 = On)	bool	7e37	32311	Not applicable
ModbusMaster.29.Data.FallBackValue	Fall back value to be written to the slave device	float32	7cb5	31925	2dp

Parameter path	Description	Type	Hex	Dec	Resolution
ModbusMaster.29.Data.ModbusAddress	Modbus register address of the data to be read/written	float32	7be4	31716	0dp
ModbusMaster.29.Data.Mode	Auto Manual mode selection (0 = Auto; 1 = Manual)	uint8	7db7	32183	Not applicable
ModbusMaster.29.Data.Number	Used for multiple instance parameters	uint8	7d2f	32047	Not applicable
ModbusMaster.29.Data.ParameterList	Parameter list for a specific slave device	uint8	7d11	32017	Not applicable
ModbusMaster.29.Data.Priority	Read/Write frequency (as for Modbus Master.1)	uint8	7c40	31808	Not applicable
ModbusMaster.29.Data.PV	Process value received from slave device	float32	7b6a	31594	2dp
ModbusMaster.29.Data.Scaling	Scaling in decimal places for non floating point data types	uint8	7d4d	32077	Not applicable
ModbusMaster.29.Data.Send	1 = send the write value to the slave	bool	7cd5	31957	Not applicable
ModbusMaster.29.Data.Set	Sets a digital value (1 = on; 0 = off)	bool	7e17	32279	Not applicable
ModbusMaster.29.Data.SlaveDevice	Slave device to communicate with.	uint8	7b30	31536	Not applicable
ModbusMaster.29.Data.Status	Transaction status (as for Modbus Master.1)	uint8	7cf3	31987	Not applicable
ModbusMaster.29.Data.Value	The value to be written to the slave device	float32	7c7a	31866	2dp
ModbusMaster.30.Data.AlarmStatus	Alarm status (as for Modbus Master.1)	uint8	7dd8	32216	Not applicable
ModbusMaster.30.Data.BitPosition	Bit position of the bit of interest in a 16 bit data type	uint8	7d6c	32108	Not applicable
ModbusMaster.30.Data.ChanAlarmStatus	Channel alarm status (as for Modbus Master.1)	uint8	7df8	32248	Not applicable
ModbusMaster.30.Data.DataType	Type of data being read/written (as for Modbus Master.1)	uint8	7c23	31779	Not applicable
ModbusMaster.30.Data.Descriptor	Description for this data item	string_t	7114	28948	Not applicable
ModbusMaster.30.Data.Digital	Digital status (0 = Off, 1 = On)	bool	7e38	32312	Not applicable
ModbusMaster.30.Data.FallBackValue	Fall back value to be written to the slave device	float32	7cb8	31928	2dp
ModbusMaster.30.Data.FunctionCode	The Modbus function code (as for Modbus Master.1)	uint8	7c05	31749	Not applicable
ModbusMaster.30.Data.ModbusAddress	Modbus register address of the data to be read/written	float32	7be6	31718	0dp
ModbusMaster.30.Data.Mode	Auto Manual mode selection (0 = Auto; 1 = Manual)	uint8	7db8	32184	Not applicable
ModbusMaster.30.Data.Number	Used for multiple instance parameters	uint8	7d30	32048	Not applicable
ModbusMaster.30.Data.ParameterList	Parameter list for a specific slave device	uint8	7d12	32018	Not applicable
ModbusMaster.30.Data.Priority	Read/Write frequency (as for Modbus Master.1)	uint8	7c41	31809	Not applicable
ModbusMaster.30.Data.PV	Process value received from slave device	float32	7b6c	31596	2dp
ModbusMaster.30.Data.Scaling	Scaling in decimal places for non floating point data types	uint8	7d4e	32078	Not applicable
ModbusMaster.30.Data.Send	1 = send the write value to the slave	bool	7cd6	31958	Not applicable
ModbusMaster.30.Data.Set	Sets a digital value (1 = on; 0 = off)	bool	7e18	32280	Not applicable
ModbusMaster.30.Data.SlaveDevice	Slave device to communicate with.	uint8	7b31	31537	Not applicable
ModbusMaster.30.Data.Status	Transaction status (as for Modbus Master.1)	uint8	7cf4	31988	Not applicable
ModbusMaster.30.Data.Value	The value to be written to the slave device	float32	7c7c	31868	2dp
ModbusMaster.Slave1.Data.AlarmStatus	Alarm status (0 = none; 1 = one or more alarms active)	uint8	7db9	32185	Not applicable
ModbusMaster.Slave1.Data.BitPosition	Bit position of the bit of interest in a 16 bit data type	uint8	7d95	32149	Not applicable
ModbusMaster.Slave1.Data.ChanAlarmStatus	Channel alarm status 0 = Off 1 = Active 2 = Safe Nak'd 3 = Active Nack'd	uint8	7dd9	32217	Not applicable
ModbusMaster.Slave1.Data.DataType	Data type of the data being read/written 0 = Real 1 = DINT 2 = INT3 = Byte 4 = UDINT 5 = UINT 6 = UBYTE8 = Real (Swap) 9 = DINT (Swap) 10 = UDINT (Swap) 11 = BIT	uint8	7d7f	32127	Not applicable
ModbusMaster.Slave1.Data.Descriptor	Description for this data item	string_t	665d	26205	Not applicable
ModbusMaster.Slave1.Data.Digital	Digital status (0 = Off; 1 = On)	bool	7e19	32281	Not applicable
ModbusMaster.Slave1.Data.FallBackValue	Fall back value to be written to the slave device	float32	7d87	32135	2dp
ModbusMaster.Slave1.Data.FunctionCode	The Modbus function code 1 = Read coil 2 = Read discrete 3 = Read holding 4 = Read input 5 = Write coil 6 = Write single 16 = Write multiple	uint8	7d7d	32125	Not applicable
ModbusMaster.Slave1.Data.ModbusAddress	Modbus register address of the data to be read/written	float32	7d79	32121	0dp
ModbusMaster.Slave1.Data.Mode	Auto Manual mode selection (0 = Auto; 1 = Manual)	uint8	7d99	32153	Not applicable
ModbusMaster.Slave1.Data.Number	Used for multiple instance parameters	uint8	7d91	32145	Not applicable
ModbusMaster.Slave1.Data.ParameterList	Parameter list for a specific slave device	uint8	7d8f	32143	Not applicable
ModbusMaster.Slave1.Data.Priority	Frequency at which the data is read/written 0 = High 1 = Medium 2 = Low 3 = Acyclic	uint8	7d81	32129	Not applicable
ModbusMaster.Slave1.Data.PV	Process value received from slave device	float32	7d73	32115	2dp
ModbusMaster.Slave1.Data.Scaling	Scaling in decimal places for non floating point data types	uint8	7d93	32147	Not applicable
ModbusMaster.Slave1.Data.Send	1 = send the write value to the slave	bool	7d8b	32139	Not applicable
ModbusMaster.Slave1.Data.Set	Sets a digital value to on (1) or off (0)	bool	7df9	32249	Not applicable
ModbusMaster.Slave1.Data.SlaveDevice	Slave device to communicate with.	uint8	7d71	32113	Not applicable
ModbusMaster.Slave1.Data.Status	Transaction status	uint8	7d8d	32141	Not applicable

Parameter path	Description	Type	Hex	Dec	Resolution
	0 = Success 1 = Illegal function 2 = Illegal address 3 = Illegal value 6 = Slave busy 8 = Parity error 9 = Bad sub 10 = Bad gateway 11 = No response 12 = Idle 13 = Pending 14 = Timeout 15 = Unknown host 16 = Connect fail 17 = No sockets 18 = Loopback fail 19 = Login fail 20 = Unknown error 22 = Write fail 23 = Master reject				
ModbusMaster.Slave1.Data.Value	The value to be written to the slave device	float32	7d83	32131	2dp
ModbusMaster.Slave1.Main.CommsFailure	1 = a device communications failure	bool	7d97	32151	Not applicable
ModbusMaster.Slave1.Main.Descriptor	Device descriptor	string_t	6633	26163	Not applicable
ModbusMaster.Slave1.Main.HighPriority	High priority rate 0 = 125ms 1 = 250ms 2 = 500 ms 3 = 1 sec 4 = 2 secs 5 = 5 secs 6 = 10 secs 7 = 20 secs 8 = 30 secs 9 = 1 min 10 = 2 mins 11 = 5 mins 12 = 10 mins 13 = 20 mins 14 = 30 mins 15 = 1 hr	uint8	7b0c	31500	Not applicable
ModbusMaster.Slave1.Main.IPAddress	Internet Protocol (IP) address for a slave device	string_t	68d3	26835	Not applicable
ModbusMaster.Slave1.Main.LowPriority	Low priority rate (as 'high priority' above)	uint8	7b10	31504	Not applicable
ModbusMaster.Slave1.Main.MaxBlockSize	Maximum amount of data in a single transaction	uint8	7b0a	31498	Not applicable
ModbusMaster.Slave1.Main.MediumPriority	Medium priority rate (as 'high priority' above)	uint8	7b0e	31502	Not applicable
ModbusMaster.Slave1.Main.Online	Enables communications (0 = offline; 1 = online)	bool	7b00	31488	Not applicable
ModbusMaster.Slave1.Main.Profile	A profile that defines the device type 0 = 3rd party 1 = Mini8 2 = 3xxx3 = 35xx 4 = 2xxx 5 = 2500 6 = 50007 = 6000 8 = nanodac 9 = EPower	uint8	7b12	31506	Not applicable
ModbusMaster.Slave1.Main.Retries	Transaction retries	uint8	7b04	31492	Not applicable
ModbusMaster.Slave1.Main.SearchDevice	Initiates a slave search (0 = No; 1 = Yes)	bool	7d6d	32109	Not applicable
ModbusMaster.Slave1.Main.SearchResult	Current search status 0 = Searching 1 = Available 2 = Unavailable 3 = Unreachable 4 = Aborted	uint8	7d6f	32111	Not applicable
ModbusMaster.Slave1.Main.Timeout	Time in milliseconds the master will wait for a response	float32	7b06	31494	0dp
ModbusMaster.Slave1.Main.UnitId	Unit id for a slave device	uint8	7b02	31490	Not applicable
ModbusMaster.Slave2.Data.AlarmStatus	Alarm status (0 = none; 1 = one or more alarms active)	uint8	7dba	32186	Not applicable
ModbusMaster.Slave2.Data.BitPosition	Bit position of the bit of interest in a 16 bit data type	uint8	7d96	32150	Not applicable
ModbusMaster.Slave2.Data.ChanAlarmStatus	Channel alarm status (as Slave1.Data)	uint8	7dda	32218	Not applicable
ModbusMaster.Slave2.Data.DataType	Data type of the data being read/written (as Slave1.Data)	uint8	7d80	32128	Not applicable
ModbusMaster.Slave2.Data.Descriptor	Description for this data item	string_t	6672	26226	Not applicable
ModbusMaster.Slave2.Data.Digital	Digital status (0 = Off; 1 = On)	bool	7e1a	32282	Not applicable
ModbusMaster.Slave2.Data.FallBackValue	Fall back value to be written to the slave device	float32	7d89	32137	2dp
ModbusMaster.Slave2.Data.FunctionCode	The Modbus function code (as Slave1.Data)	uint8	7d7e	32126	Not applicable
ModbusMaster.Slave2.Data.ModbusAddress	Modbus register address of the data to be read/written	float32	7d7b	32123	0dp
ModbusMaster.Slave2.Data.Mode	Auto Manual mode selection (0 = Auto; 1 = Manual)	uint8	7d9a	32154	Not applicable
ModbusMaster.Slave2.Data.Number	Used for multiple instance parameters	uint8	7d92	32146	Not applicable
ModbusMaster.Slave2.Data.ParameterList	Parameter list for a specific slave device	uint8	7d90	32144	Not applicable
ModbusMaster.Slave2.Data.Priority	Frequency at which the data is read/written (as Slave1.Data)	uint8	7d82	32130	Not applicable
ModbusMaster.Slave2.Data.PV	Process value received from slave device	float32	7d75	32117	2dp
ModbusMaster.Slave2.Data.Scaling	Scaling in decimal places for non floating point data types	uint8	7d94	32148	Not applicable
ModbusMaster.Slave2.Data.Send	1 = send the write value to the slave	bool	7d8c	32140	Not applicable
ModbusMaster.Slave2.Data.Set	Sets a digital value to on (1) or off (0)	bool	7dfa	32250	Not applicable
ModbusMaster.Slave2.Data.SlaveDevice	Slave device to communicate with.	uint8	7d72	32114	Not applicable
ModbusMaster.Slave2.Data.Status	Transaction status (as for Slave 1)	uint8	7d8e	32142	Not applicable
ModbusMaster.Slave2.Data.Value	The value to be written to the slave device	float32	7d85	32133	2dp
ModbusMaster.Slave2.Main.CommsFailure	1 = a device communications failure	bool	7d98	32152	Not applicable
ModbusMaster.Slave2.Main.Descriptor	Device descriptor	string_t	6648	26184	Not applicable
ModbusMaster.Slave2.Main.HighPriority	High priority rate (as for Slave 1)	uint8	7b0d	31501	Not applicable
ModbusMaster.Slave2.Main.IPAddress	Internet Protocol (IP) address for a slave device	string_t	68e5	26853	Not applicable
ModbusMaster.Slave2.Main.LowPriority	Low priority rate (as for Slave 1)	uint8	7b11	31505	Not applicable
ModbusMaster.Slave2.Main.MaxBlockSize	Maximum amount of data in a single transaction	uint8	7b0b	31499	Not applicable
ModbusMaster.Slave2.Main.MediumPriority	Medium priority rate (as for Slave 1)	uint8	7b0f	31503	Not applicable
ModbusMaster.Slave2.Main.Online	Enables communications (0 = offline; 1 = online)	bool	7b01	31489	Not applicable
ModbusMaster.Slave2.Main.Profile	A profile that defines the device type (as Slave1.Data)	uint8	7b13	31507	Not applicable
ModbusMaster.Slave2.Main.Retries	Transaction retries	uint8	7b05	31493	Not applicable
ModbusMaster.Slave2.Main.SearchDevice	Initiates a slave search (0 = No; 1 = Yes)	bool	7d6e	32110	Not applicable
ModbusMaster.Slave2.Main.SearchResult	Current search status (as Slave1.Data)	uint8	7d70	32112	Not applicable
ModbusMaster.Slave2.Main.Timeout	Time in milliseconds the master will wait for a response	float32	7b08	31496	0dp
ModbusMaster.Slave2.Main.UnitId	Unit id for a slave device	uint8	7b03	31491	Not applicable

Parameter path	Description	Type	Hex	Dec	Resolution
Mux8.1.Fallback	Fallback Strategy 0 = Clip Bad; 1 = Clip Good; 2 = Fallback Bad 3 = Fallback Good; 4 = Up scale; 5 = Down scale.	uint8	2f66	12134	Not applicable
Mux8.1.FallbackVal	Fallback Value	float32	2f67	12135	1dp
Mux8.1.HighLimit	High Limit	float32	2f69	12137	1dp
Mux8.1.In1	Input 1	float32	2f6b	12139	1dp
Mux8.1.In2	Input 2	float32	2f6c	12140	1dp
Mux8.1.In3	Input 3	float32	2f6d	12141	1dp
Mux8.1.In4	Input 4	float32	2f6e	12142	1dp
Mux8.1.In5	Input 5	float32	2f6f	12143	1dp
Mux8.1.In6	Input 6	float32	2f70	12144	1dp
Mux8.1.In7	Input 7	float32	2f71	12145	1dp
Mux8.1.In8	Input 8	float32	2f72	12146	1dp
Mux8.1.LowLimit	Low Limit	float32	2f6a	12138	1dp
Mux8.1.Out	Output	float32	2f73	12147	Set by Mux8.1.Resolution
Mux8.1.Resolution	Resolution	uint8	2f75	12149	Not applicable
Mux8.1.Select	Input Selection Switch 1 to 8 = input 1 to 8 (respectively) selected for output	uint8	2f68	12136	Not applicable
Mux8.1.Status	Status. 0 = Good (OK); 7 = Bad (Error)	bool	2f74	12148	Not applicable
Mux8.2.Fallback	Fallback Strategy (as Mux8.1.Fallback)	uint8	2f76	12150	Not applicable
Mux8.2.FallbackVal	Fallback Value	float32	2f77	12151	1dp
Mux8.2.HighLimit	High Limit	float32	2f79	12153	1dp
Mux8.2.In1	Input 1	float32	2f7b	12155	1dp
Mux8.2.In2	Input 2	float32	2f7c	12156	1dp
Mux8.2.In3	Input 3	float32	2f7d	12157	1dp
Mux8.2.In4	Input 4	float32	2f7e	12158	1dp
Mux8.2.In5	Input 5	float32	2f7f	12159	1dp
Mux8.2.In6	Input 6	float32	2f80	12160	1dp
Mux8.2.In7	Input 7	float32	2f81	12161	1dp
Mux8.2.In8	Input 8	float32	2f82	12162	1dp
Mux8.2.LowLimit	Low Limit	float32	2f7a	12154	1dp
Mux8.2.Out	Output	float32	2f83	12163	Set by Mux8.2.Resolution
Mux8.2.Resolution	Resolution	uint8	2f85	12165	Not applicable
Mux8.2.Select	Input Selection (as Mux8.1.Select)	uint8	2f78	12152	Not applicable
Mux8.2.Status	Status. 0 = Good (OK); 7 = Bad (Error)	bool	2f84	12164	Not applicable
Mux8.3.Fallback	Fallback Strategy (as Mux8.1.Fallback)	uint8	2f86	12166	Not applicable
Mux8.3.FallbackVal	Fallback Value	float32	2f87	12167	1dp
Mux8.3.HighLimit	High Limit	float32	2f89	12169	1dp
Mux8.3.In1	Input 1	float32	2f8b	12171	1dp
Mux8.3.In2	Input 2	float32	2f8c	12172	1dp
Mux8.3.In3	Input 3	float32	2f8d	12173	1dp
Mux8.3.In4	Input 4	float32	2f8e	12174	1dp
Mux8.3.In5	Input 5	float32	2f8f	12175	1dp
Mux8.3.In6	Input 6	float32	2f90	12176	1dp
Mux8.3.In7	Input 7	float32	2f91	12177	1dp
Mux8.3.In8	Input 8	float32	2f92	12178	1dp
Mux8.3.LowLimit	Low Limit	float32	2f8a	12170	1dp
Mux8.3.Out	Output	float32	2f93	12179	Set by Mux8.3.Resolution
Mux8.3.Resolution	Resolution	uint8	2f95	12181	Not applicable
Mux8.3.Select	Input Selection (as Mux8.1.Select)	uint8	2f88	12168	Not applicable
Mux8.3.Status	Status. 0 = Good (OK); 7 = Bad (Error)	bool	2f94	12180	Not applicable
Mux8.4.Fallback	Fallback Strategy (as Mux8.1.Fallback)	uint8	2f96	12182	Not applicable
Mux8.4.FallbackVal	Fallback Value	float32	2f97	12183	1dp
Mux8.4.HighLimit	High Limit	float32	2f99	12185	1dp
Mux8.4.In1	Input 1	float32	2f9b	12187	1dp
Mux8.4.In2	Input 2	float32	2f9c	12188	1dp
Mux8.4.In3	Input 3	float32	2f9d	12189	1dp
Mux8.4.In4	Input 4	float32	2f9e	12190	1dp

Parameter path	Description	Type	Hex	Dec	Resolution
Mux8.4.In6	Input 6	float32	2fa0	12192	1dp
Mux8.4.In7	Input 7	float32	2fa1	12193	1dp
Mux8.4.In8	Input 8	float32	2fa2	12194	1dp
Mux8.4.LowLimit	Low Limit	float32	2f9a	12186	1dp
Mux8.4.Out	Output	float32	2fa3	12195	Set by Mux8.4.Resolution
Mux8.4.Resolution	Resolution	uint8	2fa5	12197	Not applicable
Mux8.4.Select	Input Selection (as Mux8.1.Select)	uint8	2f98	12184	Not applicable
Mux8.4.Status	Status. 0 = Good (OK); 7 = Bad (Error)	bool	2fa4	12196	Not applicable
nano_ui.Access	Access level 0 = Logged out; 1 = Operator; 2 = Supervisor; 3 = Engineer	uint8	2c00	11264	Not applicable
nano_ui.Password	Password	string_t	5400	21504	Not applicable
Network.Archive.ArchiveRate	Rate at which to archive history files 0 = None 1 = Every minute 2 = Hourly 3 = Daily 4 = Weekly 5 = Monthly 6 = Automatic	uint8	1114	4372	Not applicable
Network.Archive.CSVDateFormat	Date/Time format (0 = Text; 1 = spreadsheet numeric)	uint8	111d	4381	Not applicable
Network.Archive.CSVHeaders	Include header details (0 = No; 1 = Yes)	bool	111b	4379	Not applicable
Network.Archive.CSVHeadings	Include headings (0 = No; 1 = Yes)	bool	111c	4380	Not applicable
Network.Archive.CSVIncludeValues	Include process values (0 = No; 1 = Yes)	bool	1119	4377	Not applicable
Network.Archive.CSVMessages	Include messages (0 = No; 1 = Yes)	bool	111a	4378	Not applicable
Network.Archive.CSVTabDelimiter	Use Tab delimiter instead of comma (0 = No; 1 = Yes)	bool	111e	4382	Not applicable
Network.Archive.Destination	Archive destination. 0 = USB; 1 = FTP Server	uint8	1111	4369	Not applicable
Network.Archive.FileFormat	Archive file format (0 = Binary; 1 = CSV; 2 = both)	uint8	1115	4373	Not applicable
Network.Archive.MediaDuration	Time in days until the USB is full	float32	1118	4376	2dp
Network.Interface.Gateway	Default gateway internet protocol address	string_t	4524	17700	Not applicable
Network.Interface.IPAddress	Internet Protocol (IP) address of this instrument	string_t	4500	17664	Not applicable
Network.Interface.IPType	IP Lookup. 0 = DHCP, 1 = Fixed	uint8	1102	4354	Not applicable
Network.Interface.MAC	Media Access Control (MAC) address of this instrument	string_t	4548	17736	Not applicable
Network.Interface.SubnetMask	Sub network identification mask	string_t	4512	17682	Not applicable
Network.Modbus.Address	Modbus address for this instrument	uint8	1140	4416	Not applicable
Network.Modbus.InputTimeout	Modbus Input inactivity timeout (in seconds)	int16	1141	4417	Not applicable
Network.Modbus.PrefMasterIP	Preferred master IP	string_t	469c	18076	Not applicable
Network.Modbus.SerialMode	Modbus serial port mode	uint8	1143	4419	Not applicable
Network.Modbus.TimeFormat	Time parameter comms resolution	uint8	1144	4420	Not applicable
Network.Modbus.UnitIdEnable	Unit ident enable	uint8	1142	4418	Not applicable
OR.1.Input1	OR Block 1, input 1. 0 = off; 1 = on	bool	2d00	11520	Not applicable
OR.1.Input2	OR Block 1, input 2. 0 = off; 1 = on	bool	2d01	11521	Not applicable
OR.1.Input3	OR Block 1, input 3. 0 = off; 1 = on	bool	2d02	11522	Not applicable
OR.1.Input4	OR Block 1, input 4. 0 = off; 1 = on	bool	2d03	11523	Not applicable
OR.1.Input5	OR Block 1, input 5. 0 = off; 1 = on	bool	2d04	11524	Not applicable
OR.1.Input6	OR Block 1, input 6. 0 = off; 1 = on	bool	2d05	11525	Not applicable
OR.1.Input7	OR Block 1, input 7. 0 = off; 1 = on	bool	2d06	11526	Not applicable
OR.1.Input8	OR Block 1, input 8. 0 = off; 1 = on	bool	2d07	11527	Not applicable
OR.1.Output	OR Block 1, output. 0 = off; 1 = on	bool	2d08	11528	Not applicable
OR.2.Input1	OR Block 2, input 1. 0 = off; 1 = on	bool	2d10	11536	Not applicable
OR.2.Input2	OR Block 2, input 2. 0 = off; 1 = on	bool	2d11	11537	Not applicable
OR.2.Input3	OR Block 2, input 3. 0 = off; 1 = on	bool	2d12	11538	Not applicable
OR.2.Input4	OR Block 2, input 4. 0 = off; 1 = on	bool	2d13	11539	Not applicable
OR.2.Input5	OR Block 2, input 5. 0 = off; 1 = on	bool	2d14	11540	Not applicable
OR.2.Input6	OR Block 2, input 6. 0 = off; 1 = on	bool	2d15	11541	Not applicable
OR.2.Input7	OR Block 2, input 7. 0 = off; 1 = on	bool	2d16	11542	Not applicable
OR.2.Input8	OR Block 2, input 8. 0 = off; 1 = on	bool	2d17	11543	Not applicable
OR.2.Output	OR Block 1, output. 0 = off; 1 = on	bool	2d18	11544	Not applicable
OR.3.Input1	OR Block 3, input 1. 0 = off; 1 = on	bool	2d20	11552	Not applicable
OR.3.Input2	OR Block 3, input 2. 0 = off; 1 = on	bool	2d21	11553	Not applicable
OR.3.Input3	OR Block 3, input 3. 0 = off; 1 = on	bool	2d22	11554	Not applicable
OR.3.Input4	OR Block 3, input 4. 0 = off; 1 = on	bool	2d23	11555	Not applicable
OR.3.Input5	OR Block 3, input 5. 0 = off; 1 = on	bool	2d24	11556	Not applicable
OR.3.Input6	OR Block 3, input 6. 0 = off; 1 = on	bool	2d25	11557	Not applicable
OR.3.Input7	OR Block 3, input 7. 0 = off; 1 = on	bool	2d26	11558	Not applicable

Parameter path	Description	Type	Hex	Dec	Resolution
OR.3.Output	OR Block 3, output. 0 = off; 1 = on	bool	2d28	11560	Not applicable
OR.4.Input1	OR Block 4, input 1. 0 = off; 1 = on	bool	2d30	11568	Not applicable
OR.4.Input2	OR Block 4, input 2. 0 = off; 1 = on	bool	2d31	11569	Not applicable
OR.4.Input3	OR Block 4, input 3. 0 = off; 1 = on	bool	2d32	11570	Not applicable
OR.4.Input4	OR Block 4, input 4. 0 = off; 1 = on	bool	2d33	11571	Not applicable
OR.4.Input5	OR Block 4, input 5. 0 = off; 1 = on	bool	2d34	11572	Not applicable
OR.4.Input6	OR Block 4, input 6. 0 = off; 1 = on	bool	2d35	11573	Not applicable
OR.4.Input7	OR Block 4, input 7. 0 = off; 1 = on	bool	2d36	11574	Not applicable
OR.4.Input8	OR Block 4, input 8. 0 = off; 1 = on	bool	2d37	11575	Not applicable
OR.4.Output	OR Block 4, output. 0 = off; 1 = on	bool	2d38	11576	Not applicable
OR.5.Input1	OR Block 5, input 1. 0 = off; 1 = on	bool	2d40	11584	Not applicable
OR.5.Input2	OR Block 5, input 2. 0 = off; 1 = on	bool	2d41	11585	Not applicable
OR.5.Input3	OR Block 5, input 3. 0 = off; 1 = on	bool	2d42	11586	Not applicable
OR.5.Input4	OR Block 5, input 4. 0 = off; 1 = on	bool	2d43	11587	Not applicable
OR.5.Input5	OR Block 5, input 5. 0 = off; 1 = on	bool	2d44	11588	Not applicable
OR.5.Input6	OR Block 5, input 6. 0 = off; 1 = on	bool	2d45	11589	Not applicable
OR.5.Input7	OR Block 5, input 7. 0 = off; 1 = on	bool	2d46	11590	Not applicable
OR.5.Input8	OR Block 5, input 8. 0 = off; 1 = on	bool	2d47	11591	Not applicable
OR.5.Output	OR Block 5, output. 0 = off; 1 = on	bool	2d48	11592	Not applicable
OR.6.Input1	OR Block 6, input 1. 0 = off; 1 = on	bool	2d50	11600	Not applicable
OR.6.Input2	OR Block 6, input 2. 0 = off; 1 = on	bool	2d51	11601	Not applicable
OR.6.Input3	OR Block 6, input 3. 0 = off; 1 = on	bool	2d52	11602	Not applicable
OR.6.Input4	OR Block 6, input 4. 0 = off; 1 = on	bool	2d53	11603	Not applicable
OR.6.Input5	OR Block 6, input 5. 0 = off; 1 = on	bool	2d54	11604	Not applicable
OR.6.Input6	OR Block 6, input 6. 0 = off; 1 = on	bool	2d55	11605	Not applicable
OR.6.Input7	OR Block 6, input 7. 0 = off; 1 = on	bool	2d56	11606	Not applicable
OR.6.Input8	OR Block 6, input 8. 0 = off; 1 = on	bool	2d57	11607	Not applicable
OR.6.Output	OR Block 6, output. 0 = off; 1 = on	bool	2d58	11608	Not applicable
OR.7.Input1	OR Block 7, input 1. 0 = off; 1 = on	bool	2d60	11616	Not applicable
OR.7.Input2	OR Block 7, input 2. 0 = off; 1 = on	bool	2d61	11617	Not applicable
OR.7.Input3	OR Block 7, input 3. 0 = off; 1 = on	bool	2d62	11618	Not applicable
OR.7.Input4	OR Block 7, input 4. 0 = off; 1 = on	bool	2d63	11619	Not applicable
OR.7.Input5	OR Block 7, input 5. 0 = off; 1 = on	bool	2d64	11620	Not applicable
OR.7.Input6	OR Block 7, input 6. 0 = off; 1 = on	bool	2d65	11621	Not applicable
OR.7.Input7	OR Block 7, input 7. 0 = off; 1 = on	bool	2d66	11622	Not applicable
OR.7.Input8	OR Block 7, input 8. 0 = off; 1 = on	bool	2d67	11623	Not applicable
OR.7.Output	OR Block 7, output. 0 = off; 1 = on	bool	2d68	11624	Not applicable
OR.8.Input1	OR Block 8, input 1. 0 = off; 1 = on	bool	2d70	11632	Not applicable
OR.8.Input2	OR Block 8, input 2. 0 = off; 1 = on	bool	2d71	11633	Not applicable
OR.8.Input3	OR Block 8, input 3. 0 = off; 1 = on	bool	2d72	11634	Not applicable
OR.8.Input4	OR Block 8, input 4. 0 = off; 1 = on	bool	2d73	11635	Not applicable
OR.8.Input5	OR Block 8, input 5. 0 = off; 1 = on	bool	2d74	11636	Not applicable
OR.8.Input6	OR Block 8, input 6. 0 = off; 1 = on	bool	2d75	11637	Not applicable
OR.8.Input7	OR Block 8, input 7. 0 = off; 1 = on	bool	2d76	11638	Not applicable
OR.8.Input8	OR Block 8, input 8. 0 = off; 1 = on	bool	2d77	11639	Not applicable
OR.8.Output	OR Block 8, output. 0 = off; 1 = on	bool	2d78	11640	Not applicable
OR.9.Input1	OR Block 9, input 1. 0 = off; 1 = on	bool	2d80	11648	Not applicable
OR.9.Input2	OR Block 9, input 2. 0 = off; 1 = on	bool	2d81	11649	Not applicable
OR.9.Input3	OR Block 9, input 3. 0 = off; 1 = on	bool	2d82	11650	Not applicable
OR.9.Input4	OR Block 9, input 4. 0 = off; 1 = on	bool	2d83	11651	Not applicable
OR.9.Input5	OR Block 9, input 5. 0 = off; 1 = on	bool	2d84	11652	Not applicable
OR.9.Input6	OR Block 9, input 6. 0 = off; 1 = on	bool	2d85	11653	Not applicable
OR.9.Input7	OR Block 9, input 7. 0 = off; 1 = on	bool	2d86	11654	Not applicable
OR.9.Input8	OR Block 9, input 8. 0 = off; 1 = on	bool	2d87	11655	Not applicable
OR.9.Output	OR Block 9, output. 0 = off; 1 = on	bool	2d88	11656	Not applicable
OR.10.Input1	OR Block 10, input 1. 0 = off; 1 = on	bool	2d90	11664	Not applicable
OR.10.Input2	OR Block 10, input 2. 0 = off; 1 = on	bool	2d91	11665	Not applicable
OR.10.Input3	OR Block 10, input 3. 0 = off; 1 = on	bool	2d92	11666	Not applicable
OR.10.Input4	OR Block 10, input 4. 0 = off; 1 = on	bool	2d93	11667	Not applicable
OR.10.Input5	OR Block 10, input 5. 0 = off; 1 = on	bool	2d94	11668	Not applicable
OR.10.Input6	OR Block 10, input 6. 0 = off; 1 = on	bool	2d95	11669	Not applicable
OR.10.Input7	OR Block 10, input 7. 0 = off; 1 = on	bool	2d96	11670	Not applicable
OR.10.Input8	OR Block 10, input 8. 0 = off; 1 = on	bool	2d97	11671	Not applicable
OR.10.Output	OR Block 10, output. 0 = off; 1 = on	bool	2d98	11672	Not applicable

Parameter path	Description	Type	Hex	Dec	Resolution
OR.10.Input8	OR Block 10, input 8. 0 = off; 1 = on	bool	2d97	11671	Not applicable
OR.10.Output	OR Block 10, output. 0 = off; 1 = on	bool	2d98	11672	Not applicable
OR.11.Input1	OR Block 11, input 1. 0 = off; 1 = on	bool	2da0	11680	Not applicable
OR.11.Input2	OR Block 11, input 2. 0 = off; 1 = on	bool	2da1	11681	Not applicable
OR.11.Input3	OR Block 11, input 3. 0 = off; 1 = on	bool	2da2	11682	Not applicable
OR.11.Input4	OR Block 11, input 4. 0 = off; 1 = on	bool	2da3	11683	Not applicable
OR.11.Input5	OR Block 11, input 5. 0 = off; 1 = on	bool	2da4	11684	Not applicable
OR.11.Input6	OR Block 11, input 6. 0 = off; 1 = on	bool	2da5	11685	Not applicable
OR.11.Input7	OR Block 11, input 7. 0 = off; 1 = on	bool	2da6	11686	Not applicable
OR.11.Input8	OR Block 11, input 8. 0 = off; 1 = on	bool	2da7	11687	Not applicable
OR.11.Output	OR Block 11, output. 0 = off; 1 = on	bool	2da8	11688	Not applicable
OR.12.Input1	OR Block 12, input 1. 0 = off; 1 = on	bool	2db0	11696	Not applicable
OR.12.Input2	OR Block 12, input 2. 0 = off; 1 = on	bool	2db1	11697	Not applicable
OR.12.Input3	OR Block 12, input 3. 0 = off; 1 = on	bool	2db2	11698	Not applicable
OR.12.Input4	OR Block 12, input 4. 0 = off; 1 = on	bool	2db3	11699	Not applicable
OR.12.Input5	OR Block 12, input 5. 0 = off; 1 = on	bool	2db4	11700	Not applicable
OR.12.Input6	OR Block 12, input 6. 0 = off; 1 = on	bool	2db5	11701	Not applicable
OR.12.Input7	OR Block 12, input 7. 0 = off; 1 = on	bool	2db6	11702	Not applicable
OR.12.Input8	OR Block 12, input 8. 0 = off; 1 = on	bool	2db7	11703	Not applicable
OR.12.Output	OR Block 12, output. 0 = off; 1 = on	bool	2db8	11704	Not applicable
Program.Ch1Holdback	Channel 1 holdback type 0 = Off 1 = Low 2 = High 3 = Band	uint8	3aa1	15009	Not applicable
Program.Ch1HoldbackVal	Channel 1 holdback value	float32	3aa3	15011	Same as Programmer.SetUp.Ch1PVInput
Program.Ch1RampUnits	Channel 1 ramp units	uint8	3aa6	15014	Not applicable
Program.Ch2Holdback	Channel 2 holdback type (as for Program.Ch1, above)	uint8	3aa2	15010	Not applicable
Program.Ch2HoldbackVal	Channel 2 holdback value	float32	3aa4	15012	Same as Programmer.SetUp.Ch2PVInput
Program.Ch2RampUnits	Channel 2 ramp units	uint8	3aa7	15015	Not applicable
Program.HoldbackStyle	Holdback style (0 = per segment; 1 = per program)	uint8	3aa0	15008	Not applicable
Program.Program	Program	string_t	6abb	27323	Not applicable
Program.RampStyle	Ramp style (0 = Time; 1 = Rate)	uint8	3aa5	15013	Not applicable
Programmer.Features.FTPStore	FTP store feature enable	bool	3a04	14852	Not applicable
Programmer.Features.Holdback	Holdback feature enable	bool	3a00	14848	Not applicable
Programmer.Features.Messages	Messages feature enable	bool	3a03	14851	Not applicable
Programmer.Features.PVEvent	PV Event feature enable	bool	3a01	14849	Not applicable
Programmer.Features.UserValue	User value feature enable	bool	3a02	14850	Not applicable
Programmer.FileList.Filename1	Filename	string_t	7900	30976	Not applicable
Programmer.FileList.Filename2	Filename	string_t	7901	30977	Not applicable
Programmer.FileList.Filename3	Filename	string_t	7902	30978	Not applicable
Programmer.FileList.Filename4	Filename	string_t	7903	30979	Not applicable
Programmer.FileList.Filename5	Filename	string_t	7904	30980	Not applicable
Programmer.FileList.Filename6	Filename	string_t	7905	30981	Not applicable
Programmer.FileList.Filename7	Filename	string_t	7906	30982	Not applicable
Programmer.FileList.Filename8	Filename	string_t	7907	30983	Not applicable
Programmer.FileList.Filename9	Filename	string_t	7908	30984	Not applicable
Programmer.FileList.Filename10	Filename	string_t	7909	30985	Not applicable
Programmer.FileList.Filename11	Filename	string_t	790a	30986	Not applicable
Programmer.FileList.Filename12	Filename	string_t	790b	30987	Not applicable
Programmer.FileList.Filename13	Filename	string_t	790c	30988	Not applicable
Programmer.FileList.Filename14	Filename	string_t	790d	30989	Not applicable
Programmer.FileList.Filename15	Filename	string_t	790e	30990	Not applicable
Programmer.FileList.Filename16	Filename	string_t	790f	30991	Not applicable
Programmer.FileList.Filename17	Filename	string_t	7910	30992	Not applicable
Programmer.FileList.Filename18	Filename	string_t	7911	30993	Not applicable
Programmer.FileList.Filename19	Filename	string_t	7912	30994	Not applicable
Programmer.FileList.Filename20	Filename	string_t	7913	30995	Not applicable
Programmer.FileList.Filename21	Filename	string_t	7914	30996	Not applicable
Programmer.FileList.Filename22	Filename	string_t	7915	30997	Not applicable
Programmer.FileList.Filename23	Filename	string_t	7916	30998	Not applicable
Programmer.FileList.Filename24	Filename	string_t	7917	30999	Not applicable

Parameter path	Description	Type	Hex	Dec	Resolution
Programmer.FileList.FileName26	Filename	string_t	7919	31001	Not applicable
Programmer.FileList.FileName27	Filename	string_t	791a	31002	Not applicable
Programmer.FileList.FileName28	Filename	string_t	791b	31003	Not applicable
Programmer.FileList.FileName29	Filename	string_t	791c	31004	Not applicable
Programmer.FileList.FileName30	Filename	string_t	791d	31005	Not applicable
Programmer.FileList.FileName31	Filename	string_t	791e	31006	Not applicable
Programmer.FileList.FileName32	Filename	string_t	791f	31007	Not applicable
Programmer.FileList.FileName33	Filename	string_t	7920	31008	Not applicable
Programmer.FileList.FileName34	Filename	string_t	7921	31009	Not applicable
Programmer.FileList.FileName35	Filename	string_t	7922	31010	Not applicable
Programmer.FileList.FileName36	Filename	string_t	7923	31011	Not applicable
Programmer.FileList.FileName37	Filename	string_t	7924	31012	Not applicable
Programmer.FileList.FileName38	Filename	string_t	7925	31013	Not applicable
Programmer.FileList.FileName39	Filename	string_t	7926	31014	Not applicable
Programmer.FileList.FileName40	Filename	string_t	7927	31015	Not applicable
Programmer.FileList.FileName41	Filename	string_t	7928	31016	Not applicable
Programmer.FileList.FileName42	Filename	string_t	7929	31017	Not applicable
Programmer.FileList.FileName43	Filename	string_t	792a	31018	Not applicable
Programmer.FileList.FileName44	Filename	string_t	792b	31019	Not applicable
Programmer.FileList.FileName45	Filename	string_t	792c	31020	Not applicable
Programmer.FileList.FileName46	Filename	string_t	792d	31021	Not applicable
Programmer.FileList.FileName47	Filename	string_t	792e	31022	Not applicable
Programmer.FileList.FileName48	Filename	string_t	792f	31023	Not applicable
Programmer.FileList.FileName49	Filename	string_t	7930	31024	Not applicable
Programmer.FileList.FileName50	Filename	string_t	7931	31025	Not applicable
Programmer.FileList.FileName51	Filename	string_t	7932	31026	Not applicable
Programmer.FileList.FileName52	Filename	string_t	7933	31027	Not applicable
Programmer.FileList.FileName53	Filename	string_t	7934	31028	Not applicable
Programmer.FileList.FileName54	Filename	string_t	7935	31029	Not applicable
Programmer.FileList.FileName55	Filename	string_t	7936	31030	Not applicable
Programmer.FileList.FileName56	Filename	string_t	7937	31031	Not applicable
Programmer.FileList.FileName57	Filename	string_t	7938	31032	Not applicable
Programmer.FileList.FileName58	Filename	string_t	7939	31033	Not applicable
Programmer.FileList.FileName59	Filename	string_t	793a	31034	Not applicable
Programmer.FileList.FileName60	Filename	string_t	793b	31035	Not applicable
Programmer.FileList.FileName61	Filename	string_t	793c	31036	Not applicable
Programmer.FileList.FileName62	Filename	string_t	793d	31037	Not applicable
Programmer.FileList.FileName63	Filename	string_t	793e	31038	Not applicable
Programmer.FileList.FileName64	Filename	string_t	793f	31039	Not applicable
Programmer.FileList.FileName65	Filename	string_t	7940	31040	Not applicable
Programmer.FileList.FileName66	Filename	string_t	7941	31041	Not applicable
Programmer.FileList.FileName67	Filename	string_t	7942	31042	Not applicable
Programmer.FileList.FileName68	Filename	string_t	7943	31043	Not applicable
Programmer.FileList.FileName69	Filename	string_t	7944	31044	Not applicable
Programmer.FileList.FileName70	Filename	string_t	7945	31045	Not applicable
Programmer.FileList.FileName71	Filename	string_t	7946	31046	Not applicable
Programmer.FileList.FileName72	Filename	string_t	7947	31047	Not applicable
Programmer.FileList.FileName73	Filename	string_t	7948	31048	Not applicable
Programmer.FileList.FileName74	Filename	string_t	7949	31049	Not applicable
Programmer.FileList.FileName75	Filename	string_t	794a	31050	Not applicable
Programmer.FileList.FileName76	Filename	string_t	794b	31051	Not applicable
Programmer.FileList.FileName77	Filename	string_t	794c	31052	Not applicable
Programmer.FileList.FileName78	Filename	string_t	794d	31053	Not applicable
Programmer.FileList.FileName79	Filename	string_t	794e	31054	Not applicable
Programmer.FileList.FileName80	Filename	string_t	794f	31055	Not applicable
Programmer.FileList.FileName81	Filename	string_t	7950	31056	Not applicable
Programmer.FileList.FileName82	Filename	string_t	7951	31057	Not applicable
Programmer.FileList.FileName83	Filename	string_t	7952	31058	Not applicable
Programmer.FileList.FileName84	Filename	string_t	7953	31059	Not applicable
Programmer.FileList.FileName85	Filename	string_t	7954	31060	Not applicable
Programmer.FileList.FileName86	Filename	string_t	7955	31061	Not applicable

Parameter path	Description	Type	Hex	Dec	Resolution
Programmer.FileList.FileName88	Filename	string_t	7957	31063	Not applicable
Programmer.FileList.FileName89	Filename	string_t	7958	31064	Not applicable
Programmer.FileList.FileName90	Filename	string_t	7959	31065	Not applicable
Programmer.FileList.FileName91	Filename	string_t	795a	31066	Not applicable
Programmer.FileList.FileName92	Filename	string_t	795b	31067	Not applicable
Programmer.FileList.FileName93	Filename	string_t	795c	31068	Not applicable
Programmer.FileList.FileName94	Filename	string_t	795d	31069	Not applicable
Programmer.FileList.FileName95	Filename	string_t	795e	31070	Not applicable
Programmer.FileList.FileName96	Filename	string_t	795f	31071	Not applicable
Programmer.FileList.FileName97	Filename	string_t	7960	31072	Not applicable
Programmer.FileList.FileName98	Filename	string_t	7961	31073	Not applicable
Programmer.FileList.FileName99	Filename	string_t	7962	31074	Not applicable
Programmer.FileList.FileName100	Filename	string_t	7963	31075	Not applicable
Programmer.FileList.FileNameEntry	Filename of the program to loaded or stored	string_t	6a91	27281	Not applicable
Programmer.FileList.Operation	Operation (0 = Complete; 1 = Get listing; 2 = iTools only)	uint8	3a80	14976	Not applicable
Programmer.FileList.RefreshList	Refresh list (0 = No; 1 = Yes)	bool	3a81	14977	Not applicable
Programmer.FTP.IPAddress	Internet Protocol address	string_t	698c	27020	Not applicable
Programmer.FTP.Password	Password	string_t	6a2c	27180	Not applicable
Programmer.FTP.Username	Username	string_t	6a03	27139	Not applicable
Programmer.Run.Ch1PSP	Channel 1 programmer set-point	float32	3a53	14931	Same as Programmer.SetUp.Ch1PVInput
Programmer.Run.Ch1PVEvent	Channel 1 PV event (0 = Off; 1 = On)	bool	3a6c	14956	Not applicable
Programmer.Run.Ch1Rate	Channel 1 rate	float32	3a5e	14942	Set by Programmer.SetUp.RateResolution
Programmer.Run.Ch1Time	Channel 1 time	time_t	3a5c	14940	Set by Network.Modbus.TimeFormat
Programmer.Run.Ch1TSP	Channel 1 target set-point	float32	3a5a	14938	Same as Programmer.SetUp.Ch1PVInput
Programmer.Run.Ch1UserVal	Channel 1 user value	float32	3a6a	14954	0dp
Programmer.Run.Ch2PSP	Channel 2 programmer set-point	float32	3a54	14932	Same as Programmer.SetUp.Ch2PVInput
Programmer.Run.Ch2PVEvent	Channel 2 PV event (0 = Off; 1 = On)	bool	3a6d	14957	Not applicable
Programmer.Run.Ch2Rate	Channel 2 rate	float32	3a5f	14943	Set by Programmer.SetUp.RateResolution
Programmer.Run.Ch2Time	Channel 2 time	time_t	3a5d	14941	Set by Network.Modbus.TimeFormat
Programmer.Run.Ch2TSP	Channel 2 target set-point	float32	3a5b	14939	Same as Programmer.SetUp.Ch2PVInput
Programmer.Run.Ch2UserVal	Channel 2 user value	float32	3a6b	14955	0dp
Programmer.Run.CyclesLeft	Cycles left (-1 = continuous)	int16	3a60	14944	Not applicable
Programmer.Run.Duration	Duration	time_t	3a59	14937	Set by Network.Modbus.TimeFormat
Programmer.Run.EndOutput	End output (0 = Off; 1 = On)	bool	3a61	14945	Not applicable
Programmer.Run.Event1	Event 1 (0 = Off; 1 = On)	bool	3a62	14946	Not applicable
Programmer.Run.Event2	Event 2 (0 = Off; 1 = On)	bool	3a63	14947	Not applicable
Programmer.Run.Event3	Event 3 (0 = Off; 1 = On)	bool	3a64	14948	Not applicable
Programmer.Run.Event4	Event 4 (0 = Off; 1 = On)	bool	3a65	14949	Not applicable
Programmer.Run.Event5	Event 5 (0 = Off; 1 = On)	bool	3a66	14950	Not applicable
Programmer.Run.Event6	Event 6 (0 = Off; 1 = On)	bool	3a67	14951	Not applicable
Programmer.Run.Event7	Event 7 (0 = Off; 1 = On)	bool	3a68	14952	Not applicable
Programmer.Run.Event8	Event 8 (0 = Off; 1 = On)	bool	3a69	14953	Not applicable
Programmer.Run.Intervention	Intervention 0 = No Program 1 = None 2 = User intervention 4 = PV Event	uint8	3a6f	14959	Not applicable
Programmer.Run.Mode	Mode (1 = Reset; 2 = Run; 4 = Hold)	uint8	3a50	14928	Not applicable
Programmer.Run.ProgTimeLeft	Program time left	time_t	3a57	14935	Set by Network.Modbus.TimeFormat
Programmer.Run.ProgTimeRunning	Program time running	time_t	3a70	14960	Set by Network.Modbus.TimeFormat
Programmer.Run.ProgTimeSpent	Program time spent	time_t	3a58	14936	Set by Network.Modbus.TimeFormat
Programmer.Run.Segment	Segment	string_t	6aa6	27302	Not applicable
Programmer.Run.SegmentType	Segment type 0 = End 1 = Ramp 2 = Dwell 3 = Step 4 = Wait 5 = Go back	uint8	3a52	14930	Not applicable
Programmer.Run.SegTimeLeft	Segment time left	time_t	3a55	14933	Set by Network.Modbus.TimeFormat
Programmer.Run.SegTimeRun	Segment time run	time_t	3a56	14934	Set by Network.Modbus.TimeFormat
Programmer.Run.Status	Status 1 = Reset 2 = Running 4 = Holding 8 = Holdback 16 = Waiting 32 = Complete	uint8	3a51	14929	Not applicable
Programmer.SetUp.Advance	Advance (0 = No 1 = Yes)	bool	3a42	14914	Not applicable
Programmer.SetUp.Amended	Amended (0 = No 1 = Yes)	bool	3a44	14916	Not applicable
Programmer.SetUp.Ch1PVInput	Channel 1 PV input	float32	3a26	14886	Set by Programmer.SetUp.Ch1Resolution
Programmer.SetUp.Ch1Resolution	Channel 1 Resolution	uint8	3a46	14918	Not applicable

Parameter path	Description	Type	Hex	Dec	Resolution
Programmer.SetUp.Ch1SPInput	Channel 1 SP input	float32	3a28	14888	0dp
Programmer.SetUp.Ch1Units	Channel 1 units	string_t	6a85	27269	Not applicable
Programmer.SetUp.Ch2PVInput	Channel 2 PV input	float32	3a27	14887	Set by Programmer.SetUp.Ch2Resolution
Programmer.SetUp.Ch2Resolution	Channel 2 Resolution	uint8	3a47	14919	Not applicable
Programmer.SetUp.Ch2ServoTo	Channel 2 servo to (0 = PV; 1 = SP)	uint8	3a2b	14891	Not applicable
Programmer.SetUp.Ch2SPInput	Channel 2 SP input	float32	3a29	14889	0dp
Programmer.SetUp.Ch2Units	Channel 2 units	string_t	6a8b	27275	Not applicable
Programmer.SetUp.Channels	Number of channels	uint8	3a20	14880	Not applicable
Programmer.SetUp.FileErrorStatus	File error status 0 = Busy 1 = OK 2 = Load open file 3 = Store open file 4 = Delete fail 5 = Copy fail 6 = Invalid format 7 = Invalid device 8 = Invalid version 9 = Invalid number of channels 10 = Parameter write failed 11 = Store operation failed to complete 12 = Load operation failed to complete 13 = Delete operation failed to complete 14 = Copy operation failed to complete 15 = Invalid filename entered or selected 16 = General file operation error 17 = Would result in more than the ma.x no. of program files	uint8	3a45	14917	Not applicable
Programmer.SetUp.Hold	Hold (0 = No 1 = Yes)	bool	3a39	14905	Not applicable
Programmer.SetUp.MaxEvents	Maximum events	uint8	3a2d	14893	Not applicable
Programmer.SetUp.Operation	Operation 1 = Select 2 = Load 4 = Store 8 = Delete 16 = Delete All 32 = Copy 64 = Copy All	uint8	3a40	14912	Not applicable
Programmer.SetUp.PowerFailAction	Power fail action (0 = ramp back; 1 = Reset; 2 = Continue)	uint8	3a2c	14892	Not applicable
Programmer.SetUp.ProgEditAccess	Program edit access level 0 = Logged out 1 = Operator 2 = Supervisor 3 = Engineer	uint8	3a22	14882	Not applicable
Programmer.SetUp.ProgModeAccess	Program mode access level (as Program Edit Access, above)	uint8	3a21	14881	Not applicable
Programmer.SetUp.ProgNum	Program Number	uint8	3a48	14920	Not applicable
Programmer.SetUp.ProgStoreAccess	Program store access level (as Program Edit Access, above)	uint8	3a23	14883	Not applicable
Programmer.SetUp.RateResolution	Rate resolution	uint8	3a24	14884	Not applicable
Programmer.SetUp.Reset	Reset (0 = No 1 = Yes)	bool	3a3a	14906	Not applicable
Programmer.SetUp.ResetCh1UserVal	Reset channel 1 user value	float32	3a36	14902	1dp
Programmer.SetUp.ResetCh2UserVal	Reset channel 2 user value	float32	3a37	14903	1dp
Programmer.SetUp.ResetEvent1	Reset event 1 (0 = Off, 1 = On)	bool	3a2e	14894	Not applicable
Programmer.SetUp.ResetEvent2	Reset event 2 (0 = Off, 1 = On)	bool	3a2f	14895	Not applicable
Programmer.SetUp.ResetEvent3	Reset event 3 (0 = Off, 1 = On)	bool	3a30	14896	Not applicable
Programmer.SetUp.ResetEvent4	Reset event 4 (0 = Off, 1 = On)	bool	3a31	14897	Not applicable
Programmer.SetUp.ResetEvent5	Reset event 5 (0 = Off, 1 = On)	bool	3a32	14898	Not applicable
Programmer.SetUp.ResetEvent6	Reset event 6 (0 = Off, 1 = On)	bool	3a33	14899	Not applicable
Programmer.SetUp.ResetEvent7	Reset event 7 (0 = Off, 1 = On)	bool	3a34	14900	Not applicable
Programmer.SetUp.ResetEvent8	Reset event 8 (0 = Off, 1 = On)	bool	3a35	14901	Not applicable
Programmer.SetUp.Run	Run (0 = No 1 = Yes)	bool	3a38	14904	Not applicable
Programmer.SetUp.RunHold	Run Hold (0 = No 1 = Yes)	bool	3a3c	14908	Not applicable
Programmer.SetUp.RunReset	Run Reset (0 = No 1 = Yes)	bool	3a3b	14907	Not applicable
Programmer.SetUp.Status	Status 0 = Inactive 1 = Success 2 = Failed 3 = Loading 4 = Storing 5 = Deleting 6 = Copying	uint8	3a41	14913	Not applicable
Programmer.SetUp.WaitAnalog1	Wait analog input 1	float32	3a3e	14910	0dp
Programmer.SetUp.WaitAnalog2	Wait analog input 2	float32	3a3f	14911	0dp
Programmer.SetUp.WaitDigital	Wait Digital (0 = Off 1 = On)	bool	3a3d	14909	Not applicable
RealTimeEvent.1.Duration	Sets the duration for the event to remain On	time_t	30e6	12518	Set by Network.Modbus.TimeFormat
RealTimeEvent.1.OffDate	Sets the date in the month that the event is to switch off	uint8	30e8	12520	Not applicable
RealTimeEvent.1.OffDay	Sets the day the event is to switch Off	uint8	30e9	12521	Not applicable

Parameter path	Description	Type	Hex	Dec	Resolution
	0 = Sunday 1 = Monday 2 = Tuesday 3 = Wednesday 4 = Thursday 5 = Friday 6 = Saturday 7 = Monday to Friday 8 = Saturday to Sunday 9 = Every day				
RealTimeEvent.1.OffMonth	The month number when the event is to switch off	uint8	30e7	12519	Not applicable
RealTimeEvent.1.OffTime	Sets the time that the event is to switch Off	time_t	30ea	12522	Set by Network.Modbus.TimeFormat
RealTimeEvent.1.OffType	0 = Duration; 1 = Time	uint8	30e5	12517	Not applicable
RealTimeEvent.1.OnDate	Sets the date in the month that the event is to switch on	uint8	30e2	12514	Not applicable
RealTimeEvent.1.OnDay	Sets the day on which event is to switch on (as 'OffDay', above)	uint8	30e3	12515	Not applicable
RealTimeEvent.1.OnMonth	The month number when the event is to switch on	uint8	30e1	12513	Not applicable
RealTimeEvent.1.OnTime	Sets the time that the event is to switch On	time_t	30e4	12516	Set by Network.Modbus.TimeFormat
RealTimeEvent.1.Output	The output from the real time event (0 = Off; 1 = On)	bool	30eb	12523	Not applicable
RealTimeEvent.1.Type	Selects the type of Real Time Event 0 = Off 1 = Time and Day 2 = Time and Date	uint8	30e0	12512	Not applicable
RealTimeEvent.2.Duration	Sets the duration for the event to remain On	time_t	30f6	12534	Set by Network.Modbus.TimeFormat
RealTimeEvent.2.OffDate	Sets the date in the month that the event is to switch off	uint8	30f8	12536	Not applicable
RealTimeEvent.2.OffDay	Sets the day the event is to switch Off (as for Event 1)	uint8	30f9	12537	Not applicable
RealTimeEvent.2.OffMonth	Sets the month that the event is to switch off	uint8	30f7	12535	Not applicable
RealTimeEvent.2.OffTime	Sets the time that the event is to switch Off	time_t	30fa	12538	Set by Network.Modbus.TimeFormat
RealTimeEvent.2.OffType	Selects the type that will switch off the event (as for Event 1)	uint8	30f5	12533	Not applicable
RealTimeEvent.2.OnDate	Sets the date in the month that the event is to switch on	uint8	30f2	12530	Not applicable
RealTimeEvent.2.OnDay	Sets the day the event is to switch on (as for Event 1)	uint8	30f3	12531	Not applicable
RealTimeEvent.2.OnMonth	Sets the month that the event is to switch on	uint8	30f1	12529	Not applicable
RealTimeEvent.2.OnTime	Sets the time that the event is to switch On	time_t	30f4	12532	Set by Network.Modbus.TimeFormat
RealTimeEvent.2.Output	The output from the real time event (0 = Off; 1 = On)	bool	30fb	12539	Not applicable
RealTimeEvent.2.Type	Selects the type of Real Time Event 0 = Off 1 = Time and Day 2 = Time and Date	uint8	30f0	12528	Not applicable
SaturatedSteam.Mode	The mode of steam calculation	string_t	2e32	11826	Not applicable
SaturatedSteam.Flow	Flow Input	float32	2e33	11827	Set by SaturatedSteam.Resolution
SaturatedSteam.Use	Use Temperature or Pressure	string_t	2e35	11829	Not applicable
SaturatedSteam.Temperature	Temperature Input	float32	2e36	11830	Set by SaturatedSteam.Resolution
SaturatedSteam.Dryness	Dryness Constant, %	float32	2e38	11832	Set by SaturatedSteam.Resolution
SaturatedSteam.HeatFlow	Heat flow output	float32	2e39	11833	Set by SaturatedSteam.Resolution
SaturatedSteam.Resolution	Resolution to which the steam parameters are displayed	float32	2e3c	11836	0dp
Segment.1.Ch1Holdback	Channel 1 holdback type 0 = Off 1 = Low 2 = High 3 = Band	uint8	3ac9	15049	Not applicable
Segment.1.Ch1HoldbackVal	Channel 1 holdback value	float32	3acb	15051	Same as Programmer.SetUp.Ch1PVInput
Segment.1.Ch1PVEvent	Channel 1 PV event 0 = Off 1 = Absolute High 2 = Absolute Low 3 = Deviation High 4 = Deviation Low 5 = Deviation Band	uint8	3ad4	15060	Not applicable
Segment.1.Ch1PVEventUse	Channel 1 PV event use (0 = Trigger; 1 = Alarm)	bool	3ae2	15074	Not applicable
Segment.1.Ch1PVEventVal	Channel 1 PV event value	float32	3ad6	15062	Same as Programmer.SetUp.Ch1PVInput
Segment.1.Ch1Rate	Channel 1 rate	float32	3ac6	15046	Set by Programmer.SetUp.RateResolution
Segment.1.Ch1Time	Channel 1 time	time_t	3ac4	15044	Set by Network.Modbus.TimeFormat
Segment.1.Ch1TSP	Channel 1 target set-point	float32	3ac2	15042	Same as Programmer.SetUp.Ch1PVInput
Segment.1.Ch1UserVal	Channel 1 user value	float32	3ad8	15064	Same as Programmer.SetUp.ResetCh1UserVal
Segment.1.Ch1Wait	Channel 1 Wait (Analogue 1 criterion) 1 = Abs high 2 = Abs low 3 = Dev high 4 = Dev Low	uint8	3ace	15054	Not applicable
Segment.1.Ch1WaitVal	Channel 1 wait value	float32	3ad0	15056	Same as Programmer.SetUp.PVWait1
Segment.1.Ch2Holdback	Channel 2 holdback type (as for Ch1Holdback, above)	uint8	3aca	15050	Not applicable
Segment.1.Ch2HoldbackVal	Channel 2 holdback value	float32	3acc	15052	Same as Programmer.SetUp.Ch2PVInput
Segment.1.Ch2PVEvent	Channel 2 PV event (as for Ch1PVEvent, above)	uint8	3ad5	15061	Not applicable
Segment.1.Ch2PVEventUse	Channel 2 PV event use (as for Ch1PVEventUse, above)	bool	3ae3	15075	Not applicable
Segment.1.Ch2PVEventVal	Channel 2 PV event value	float32	3ad7	15063	Same as Programmer.SetUp.Ch2PVInput
Segment.1.Ch2Rate	Channel 2 rate	float32	3ac7	15047	Set by Programmer.SetUp.RateResolution
Segment.1.Ch2Time	Channel 2 time	time_t	3ac5	15045	Set by Network.Modbus.TimeFormat
Segment.1.Ch2TSP	Channel 2 target set-point	float32	3ac3	15043	Same as Programmer.SetUp.Ch2PVInput
Segment.1.Ch2UserVal	Channel 2 user value	float32	3ad9	15065	Same as Programmer.SetUp.ResetCh2UserVal

Parameter path	Description	Type	Hex	Dec	Resolution
Segment.3.Ch1Holdback	Channel 1 holdback type	uint8	3b29	15145	Not applicable
Segment.3.Ch1HoldbackVal	Channel 1 holdback value	float32	3b2b	15147	Same as Programmer.Setup.Ch1PVInput
Segment.3.Ch1PVEvent	Channel 1 PV event	uint8	3b34	15156	Not applicable
Segment.3.Ch1PVEventUse	Channel 1 PV event use	bool	3b42	15170	Not applicable
Segment.3.Ch1PVEventVal	Channel 1 PV event value	float32	3b36	15158	Same as Programmer.Setup.Ch1PVInput
Segment.3.Ch1Rate	Channel 1 rate	float32	3b26	15142	Set by Programmer.Setup.RateResolution
Segment.3.Ch1Time	Channel 1 time	time_t	3b24	15140	Set by Network.Modbus.TimeFormat
Segment.3.Ch1TSP	Channel 1 target set-point	float32	3b22	15138	Same as Programmer.Setup.Ch1PVInput
Segment.3.Ch1UserVal	Channel 1 user value	float32	3b38	15160	Same as Programmer.Setup.ResetCh1UserVal
Segment.3.Ch1Wait	Channel 1 Wait	uint8	3b2e	15150	Not applicable
Segment.3.Ch1WaitVal	Channel 1 wait value	float32	3b30	15152	Same as Programmer.Setup.PVWait1
Segment.3.Ch2Holdback	Channel 2 holdback type	uint8	3b2a	15146	Not applicable
Segment.3.Ch2HoldbackVal	Channel 2 holdback value	float32	3b2c	15148	Same as Programmer.Setup.Ch2PVInput
Segment.3.Ch2PVEvent	Channel 2 PV event	uint8	3b35	15157	Not applicable
Segment.3.Ch2PVEventUse	Channel 2 PV event use	bool	3b43	15171	Not applicable
Segment.3.Ch2PVEventVal	Channel 2 PV event value	float32	3b37	15159	Same as Programmer.Setup.Ch2PVInput
Segment.3.Ch2Rate	Channel 2 rate	float32	3b27	15143	Set by Programmer.Setup.RateResolution
Segment.3.Ch2Time	Channel 2 time	time_t	3b25	15141	Set by Network.Modbus.TimeFormat
Segment.3.Ch2TSP	Channel 2 target set-point	float32	3b23	15139	Same as Programmer.Setup.Ch2PVInput
Segment.3.Ch2UserVal	Channel 2 user value	float32	3b39	15161	Same as Programmer.Setup.ResetCh2UserVal
Segment.3.Ch2Wait	Channel 2 Wait	uint8	3b2f	15151	Not applicable
Segment.3.Ch2WaitVal	Channel 2 wait value	float32	3b31	15153	Same as Programmer.Setup.PVWait2
Segment.3.Cycles	Cycles	int16	3b33	15155	Not applicable
Segment.3.Duration	Duration	time_t	3b21	15137	Set by Network.Modbus.TimeFormat
Segment.3.EndType	End type	uint8	3b28	15144	Not applicable
Segment.3.Event1	Event 1	bool	3b3a	15162	Not applicable
Segment.3.Event2	Event 2	bool	3b3b	15163	Not applicable
Segment.3.Event3	Event 3	bool	3b3c	15164	Not applicable
Segment.3.Event4	Event 4	bool	3b3d	15165	Not applicable
Segment.3.Event5	Event 5	bool	3b3e	15166	Not applicable
Segment.3.Event6	Event 6	bool	3b3f	15167	Not applicable
Segment.3.Event7	Event 7	bool	3b40	15168	Not applicable
Segment.3.Event8	Event 8	bool	3b41	15169	Not applicable
Segment.3.GoBackTo	Go back to	uint8	3b32	15154	Not applicable
Segment.3.SegmentName	Segment name	string_t	6afa	27386	Not applicable
Segment.3.Type	Type	uint8	3b20	15136	Not applicable
Segment.3.WaitFor	Wait for	uint8	3b2d	15149	Not applicable
Segment 4 For parameter values and settings (enumerations) see Segment 1					
Segment.4.Ch1Holdback	Channel 1 holdback type	uint8	3b59	15193	Not applicable
Segment.4.Ch1HoldbackVal	Channel 1 holdback value	float32	3b5b	15195	Same as Programmer.Setup.Ch1PVInput
Segment.4.Ch1PVEvent	Channel 1 PV event	uint8	3b64	15204	Not applicable
Segment.4.Ch1PVEventUse	Channel 1 PV event use	bool	3b72	15218	Not applicable
Segment.4.Ch1PVEventVal	Channel 1 PV event value	float32	3b66	15206	Same as Programmer.Setup.Ch1PVInput
Segment.4.Ch1Rate	Channel 1 rate	float32	3b56	15190	Set by Programmer.Setup.RateResolution
Segment.4.Ch1Time	Channel 1 time	time_t	3b54	15188	Set by Network.Modbus.TimeFormat
Segment.4.Ch1TSP	Channel 1 target set-point	float32	3b52	15186	Same as Programmer.Setup.Ch1PVInput
Segment.4.Ch1UserVal	Channel 1 user value	float32	3b68	15208	Same as Programmer.Setup.ResetCh1UserVal
Segment.4.Ch1Wait	Channel 1 Wait	uint8	3b5e	15198	Not applicable
Segment.4.Ch1WaitVal	Channel 1 wait value	float32	3b60	15200	Same as Programmer.Setup.PVWait1
Segment.4.Ch2Holdback	Channel 2 holdback type	uint8	3b5a	15194	Not applicable
Segment.4.Ch2HoldbackVal	Channel 2 holdback value	float32	3b5c	15196	Same as Programmer.Setup.Ch2PVInput
Segment.4.Ch2PVEvent	Channel 2 PV event	uint8	3b65	15205	Not applicable
Segment.4.Ch2PVEventUse	Channel 2 PV event use	bool	3b73	15219	Not applicable
Segment.4.Ch2PVEventVal	Channel 2 PV event value	float32	3b67	15207	Same as Programmer.Setup.Ch2PVInput
Segment.4.Ch2Rate	Channel 2 rate	float32	3b57	15191	Set by Programmer.Setup.RateResolution
Segment.4.Ch2Time	Channel 2 time	time_t	3b55	15189	Set by Network.Modbus.TimeFormat
Segment.4.Ch2TSP	Channel 2 target set-point	float32	3b53	15187	Same as Programmer.Setup.Ch2PVInput
Segment.4.Ch2UserVal	Channel 2 user value	float32	3b69	15209	Same as Programmer.Setup.ResetCh2UserVal

Parameter path	Description	Type	Hex	Dec	Resolution
Segment.4.Ch2WaitVal	Channel 2 wait value	float32	3b61	15201	Same as Programmer.Setup.PVWait2
Segment.4.Cycles	Cycles	int16	3b63	15203	Not applicable
Segment.4.Duration	Duration	time_t	3b51	15185	Set by Network.Modbus.TimeFormat
Segment.4.EndType	End type	uint8	3b58	15192	Not applicable
Segment.4.Event1	Event 1	bool	3b6a	15210	Not applicable
Segment.4.Event2	Event 2	bool	3b6b	15211	Not applicable
Segment.4.Event3	Event 3	bool	3b6c	15212	Not applicable
Segment.4.Event4	Event 4	bool	3b6d	15213	Not applicable
Segment.4.Event5	Event 5	bool	3b6e	15214	Not applicable
Segment.4.Event6	Event 6	bool	3b6f	15215	Not applicable
Segment.4.Event7	Event 7	bool	3b70	15216	Not applicable
Segment.4.Event8	Event 8	bool	3b71	15217	Not applicable
Segment.4.GoBackTo	Go back to	uint8	3b62	15202	Not applicable
Segment.4.SegmentName	Segment name	string_t	6b0f	27407	Not applicable
Segment.4.Type	Type	uint8	3b50	15184	Not applicable
Segment.4.WaitFor	Wait for	uint8	3b5d	15197	Not applicable
Segment 5 For parameter values and settings (enumerations) see Segment 1					
Segment.5.Ch1Holdback	Channel 1 holdback type	uint8	3b89	15241	Not applicable
Segment.5.Ch1HoldbackVal	Channel 1 holdback value	float32	3b8b	15243	Same as Programmer.Setup.Ch1PVInput
Segment.5.Ch1PVEvent	Channel 1 PV event	uint8	3b94	15252	Not applicable
Segment.5.Ch1PVEventUse	Channel 1 PV event use	bool	3ba2	15266	Not applicable
Segment.5.Ch1PVEventVal	Channel 1 PV event value	float32	3b96	15254	Same as Programmer.Setup.Ch1PVInput
Segment.5.Ch1Rate	Channel 1 rate	float32	3b86	15238	Set by Programmer.Setup.RateResolution
Segment.5.Ch1Time	Channel 1 time	time_t	3b84	15236	Set by Network.Modbus.TimeFormat
Segment.5.Ch1TSP	Channel 1 target set-point	float32	3b82	15234	Same as Programmer.Setup.Ch1PVInput
Segment.5.Ch1UserVal	Channel 1 user value	float32	3b98	15256	Same as Programmer.Setup.ResetCh1UserVal
Segment.5.Ch1Wait	Channel 1 Wait	uint8	3b8e	15246	Not applicable
Segment.5.Ch1WaitVal	Channel 1 wait value	float32	3b90	15248	Same as Programmer.Setup.PVWait1
Segment.5.Ch2Holdback	Channel 2 holdback type	uint8	3b8a	15242	Not applicable
Segment.5.Ch2HoldbackVal	Channel 2 holdback value	float32	3b8c	15244	Same as Programmer.Setup.Ch2PVInput
Segment.5.Ch2PVEvent	Channel 2 PV event	uint8	3b95	15253	Not applicable
Segment.5.Ch2PVEventUse	Channel 2 PV event use	bool	3ba3	15267	Not applicable
Segment.5.Ch2PVEventVal	Channel 2 PV event value	float32	3b97	15255	Same as Programmer.Setup.Ch2PVInput
Segment.5.Ch2Rate	Channel 2 rate	float32	3b87	15239	Set by Programmer.Setup.RateResolution
Segment.5.Ch2Time	Channel 2 time	time_t	3b85	15237	Set by Network.Modbus.TimeFormat
Segment.5.Ch2TSP	Channel 2 target set-point	float32	3b83	15235	Same as Programmer.Setup.Ch2PVInput
Segment.5.Ch2UserVal	Channel 2 user value	float32	3b99	15257	Same as Programmer.Setup.ResetCh2UserVal
Segment.5.Ch2Wait	Channel 2 Wait	uint8	3b8f	15247	Not applicable
Segment.5.Ch2WaitVal	Channel 2 wait value	float32	3b91	15249	Same as Programmer.Setup.PVWait2
Segment.5.Cycles	Cycles	int16	3b93	15251	Not applicable
Segment.5.Duration	Duration	time_t	3b81	15233	Set by Network.Modbus.TimeFormat
Segment.5.EndType	End type	uint8	3b88	15240	Not applicable
Segment.5.Event1	Event 1	bool	3b9a	15258	Not applicable
Segment.5.Event2	Event 2	bool	3b9b	15259	Not applicable
Segment.5.Event3	Event 3	bool	3b9c	15260	Not applicable
Segment.5.Event4	Event 4	bool	3b9d	15261	Not applicable
Segment.5.Event5	Event 5	bool	3b9e	15262	Not applicable
Segment.5.Event6	Event 6	bool	3b9f	15263	Not applicable
Segment.5.Event7	Event 7	bool	3ba0	15264	Not applicable
Segment.5.Event8	Event 8	bool	3ba1	15265	Not applicable
Segment.5.GoBackTo	Go back to	uint8	3b92	15250	Not applicable
Segment.5.SegmentName	Segment name	string_t	6b24	27428	Not applicable
Segment.5.Type	Type	uint8	3b80	15232	Not applicable
Segment.5.WaitFor	Wait for	uint8	3b8d	15245	Not applicable
Segment 6 For parameter values and settings (enumerations) see Segment 1					
Segment.6.Ch1Holdback	Channel 1 holdback type	uint8	3bb9	15289	Not applicable
Segment.6.Ch1HoldbackVal	Channel 1 holdback value	float32	3bbb	15291	Same as Programmer.Setup.Ch1PVInput
Segment.6.Ch1PVEvent	Channel 1 PV event	uint8	3ba4	15268	Not applicable

Parameter path	Description	Type	Hex	Dec	Resolution
Segment.6.Ch1PVEventVal	Channel 1 PV event value	float32	3bc6	15302	Same as Programmer.Setup.Ch1PVInput
Segment.6.Ch1Rate	Channel 1 rate	float32	3bb6	15286	Set by Programmer.Setup.RateResolution
Segment.6.Ch1Time	Channel 1 time	time_t	3bb4	15284	Set by Network.Modbus.TimeFormat
Segment.6.Ch1TSP	Channel 1 target set-point	float32	3bb2	15282	Same as Programmer.Setup.Ch1PVInput
Segment.6.Ch1UserVal	Channel 1 user value	float32	3bc8	15304	Same as Programmer.Setup.ResetCh1UserVal
Segment.6.Ch1Wait	Channel 1 Wait	uint8	3bbe	15294	Not applicable
Segment.6.Ch1WaitVal	Channel 1 wait value	float32	3bc0	15296	Same as Programmer.Setup.PVWait1
Segment.6.Ch2Holdback	Channel 2 holdback type	uint8	3bba	15290	Not applicable
Segment.6.Ch2HoldbackVal	Channel 2 holdback value	float32	3bbc	15292	Same as Programmer.Setup.Ch2PVInput
Segment.6.Ch2PVEvent	Channel 2 PV event	uint8	3bc5	15301	Not applicable
Segment.6.Ch2PVEventUse	Channel 2 PV event use	bool	3bd3	15315	Not applicable
Segment.6.Ch2PVEventVal	Channel 2 PV event value	float32	3bc7	15303	Same as Programmer.Setup.Ch2PVInput
Segment.6.Ch2Rate	Channel 2 rate	float32	3bb7	15287	Set by Programmer.Setup.RateResolution
Segment.6.Ch2Time	Channel 2 time	time_t	3bb5	15285	Set by Network.Modbus.TimeFormat
Segment.6.Ch2TSP	Channel 2 target set-point	float32	3bb3	15283	Same as Programmer.Setup.Ch2PVInput
Segment.6.Ch2UserVal	Channel 2 user value	float32	3bc9	15305	Same as Programmer.Setup.ResetCh2UserVal
Segment.6.Ch2Wait	Channel 2 Wait	uint8	3bbf	15295	Not applicable
Segment.6.Ch2WaitVal	Channel 2 wait value	float32	3bc1	15297	Same as Programmer.Setup.PVWait2
Segment.6.Cycles	Cycles	int16	3bc3	15299	Not applicable
Segment.6.Duration	Duration	time_t	3bb1	15281	Set by Network.Modbus.TimeFormat
Segment.6.EndType	End type	uint8	3bb8	15288	Not applicable
Segment.6.Event1	Event 1	bool	3bca	15306	Not applicable
Segment.6.Event2	Event 2	bool	3bcb	15307	Not applicable
Segment.6.Event3	Event 3	bool	3bcc	15308	Not applicable
Segment.6.Event4	Event 4	bool	3bcd	15309	Not applicable
Segment.6.Event5	Event 5	bool	3bce	15310	Not applicable
Segment.6.Event6	Event 6	bool	3bcf	15311	Not applicable
Segment.6.Event7	Event 7	bool	3bd0	15312	Not applicable
Segment.6.Event8	Event 8	bool	3bd1	15313	Not applicable
Segment.6.GoBackTo	Go back to	uint8	3bc2	15298	Not applicable
Segment.6.SegmentName	Segment name	string_t	6b39	27449	Not applicable
Segment.6.Type	Type	uint8	3bb0	15280	Not applicable
Segment.6.WaitFor	Wait for	uint8	3bbd	15293	Not applicable
Segment 7 For parameter values and settings (enumerations) see Segment 1					
Segment.7.Ch1Holdback	Channel 1 holdback type	uint8	3be9	15337	Not applicable
Segment.7.Ch1HoldbackVal	Channel 1 holdback value	float32	3beb	15339	Same as Programmer.Setup.Ch1PVInput
Segment.7.Ch1PVEvent	Channel 1 PV event	uint8	3bf4	15348	Not applicable
Segment.7.Ch1PVEventUse	Channel 1 PV event use	bool	3c02	15362	Not applicable
Segment.7.Ch1PVEventVal	Channel 1 PV event value	float32	3bf6	15350	Same as Programmer.Setup.Ch1PVInput
Segment.7.Ch1Rate	Channel 1 rate	float32	3be6	15334	Set by Programmer.Setup.RateResolution
Segment.7.Ch1Time	Channel 1 time	time_t	3be4	15332	Set by Network.Modbus.TimeFormat
Segment.7.Ch1TSP	Channel 1 target set-point	float32	3be2	15330	Same as Programmer.Setup.Ch1PVInput
Segment.7.Ch1UserVal	Channel 1 user value	float32	3bf8	15352	Same as Programmer.Setup.ResetCh1UserVal
Segment.7.Ch1Wait	Channel 1 Wait	uint8	3bee	15342	Not applicable
Segment.7.Ch1WaitVal	Channel 1 wait value	float32	3bf0	15344	Same as Programmer.Setup.PVWait1
Segment.7.Ch2Holdback	Channel 2 holdback type	uint8	3bea	15338	Not applicable
Segment.7.Ch2HoldbackVal	Channel 2 holdback value	float32	3bec	15340	Same as Programmer.Setup.Ch2PVInput
Segment.7.Ch2PVEvent	Channel 2 PV event	uint8	3bf5	15349	Not applicable
Segment.7.Ch2PVEventUse	Channel 2 PV event use	bool	3c03	15363	Not applicable
Segment.7.Ch2PVEventVal	Channel 2 PV event value	float32	3bf7	15351	Same as Programmer.Setup.Ch2PVInput
Segment.7.Ch2Rate	Channel 2 rate	float32	3be7	15335	Set by Programmer.Setup.RateResolution
Segment.7.Ch2Time	Channel 2 time	time_t	3be5	15333	Set by Network.Modbus.TimeFormat
Segment.7.Ch2TSP	Channel 2 target set-point	float32	3be3	15331	Same as Programmer.Setup.Ch2PVInput
Segment.7.Ch2UserVal	Channel 2 user value	float32	3bf9	15353	Same as Programmer.Setup.ResetCh2UserVal
Segment.7.Ch2Wait	Channel 2 Wait	uint8	3bef	15343	Not applicable
Segment.7.Ch2WaitVal	Channel 2 wait value	float32	3bf1	15345	Same as Programmer.Setup.PVWait2
Segment.7.Cycles	Cycles	int16	3bc3	15299	Not applicable

Parameter path	Description	Type	Hex	Dec	Resolution
Segment.7.EndType	End type	uint8	3be8	15336	Not applicable
Segment.7.Event1	Event 1	bool	3bfa	15354	Not applicable
Segment.7.Event2	Event 2	bool	3bfb	15355	Not applicable
Segment.7.Event3	Event 3	bool	3bfc	15356	Not applicable
Segment.7.Event4	Event 4	bool	3bfd	15357	Not applicable
Segment.7.Event5	Event 5	bool	3bfe	15358	Not applicable
Segment.7.Event6	Event 6	bool	3bff	15359	Not applicable
Segment.7.Event7	Event 7	bool	3c00	15360	Not applicable
Segment.7.Event8	Event 8	bool	3c01	15361	Not applicable
Segment.7.GoBackTo	Go back to	uint8	3bf2	15346	Not applicable
Segment.7.SegmentName	Segment name	string_t	6b4e	27470	Not applicable
Segment.7.Type	Type	uint8	3be0	15328	Not applicable
Segment.7.WaitFor	Wait for	uint8	3bed	15341	Not applicable
Segment 8 For parameter values and settings (enumerations) see Segment 1					
Segment.8.Ch1Holdback	Channel 1 holdback type	uint8	3c19	15385	Not applicable
Segment.8.Ch1HoldbackVal	Channel 1 holdback value	float32	3c1b	15387	Same as Programmer.Setup.Ch1PVInput
Segment.8.Ch1PVEvent	Channel 1 PV event	uint8	3c24	15396	Not applicable
Segment.8.Ch1PVEventUse	Channel 1 PV event use	bool	3c32	15410	Not applicable
Segment.8.Ch1PVEventVal	Channel 1 PV event value	float32	3c26	15398	Same as Programmer.Setup.Ch1PVInput
Segment.8.Ch1Rate	Channel 1 rate	float32	3c16	15382	Set by Programmer.Setup.RateResolution
Segment.8.Ch1Time	Channel 1 time	time_t	3c14	15380	Set by Network.Modbus.TimeFormat
Segment.8.Ch1TSP	Channel 1 target set-point	float32	3c12	15378	Same as Programmer.Setup.Ch1PVInput
Segment.8.Ch1UserVal	Channel 1 user value	float32	3c28	15400	Same as Programmer.Setup.ResetCh1UserVal
Segment.8.Ch1Wait	Channel 1 Wait	uint8	3c1e	15390	Not applicable
Segment.8.Ch1WaitVal	Channel 1 wait value	float32	3c20	15392	Same as Programmer.Setup.PVWait1
Segment.8.Ch2Holdback	Channel 2 holdback type	uint8	3c1a	15386	Not applicable
Segment.8.Ch2HoldbackVal	Channel 2 holdback value	float32	3c1c	15388	Same as Programmer.Setup.Ch2PVInput
Segment.8.Ch2PVEvent	Channel 2 PV event	uint8	3c25	15397	Not applicable
Segment.8.Ch2PVEventUse	Channel 2 PV event use	bool	3c33	15411	Not applicable
Segment.8.Ch2PVEventVal	Channel 2 PV event value	float32	3c27	15399	Same as Programmer.Setup.Ch2PVInput
Segment.8.Ch2Rate	Channel 2 rate	float32	3c17	15383	Set by Programmer.Setup.RateResolution
Segment.8.Ch2Time	Channel 2 time	time_t	3c15	15381	Set by Network.Modbus.TimeFormat
Segment.8.Ch2TSP	Channel 2 target set-point	float32	3c13	15379	Same as Programmer.Setup.Ch2PVInput
Segment.8.Ch2UserVal	Channel 2 user value	float32	3c29	15401	Same as Programmer.Setup.ResetCh2UserVal
Segment.8.Ch2Wait	Channel 2 Wait	uint8	3c1f	15391	Not applicable
Segment.8.Ch2WaitVal	Channel 2 wait value	float32	3c21	15393	Same as Programmer.Setup.PVWait2
Segment.8.Cycles	Cycles	int16	3c23	15395	Not applicable
Segment.8.Duration	Duration	time_t	3c11	15377	Set by Network.Modbus.TimeFormat
Segment.8.EndType	End type	uint8	3c18	15384	Not applicable
Segment.8.Event1	Event 1	bool	3c2a	15402	Not applicable
Segment.8.Event2	Event 2	bool	3c2b	15403	Not applicable
Segment.8.Event3	Event 3	bool	3c2c	15404	Not applicable
Segment.8.Event4	Event 4	bool	3c2d	15405	Not applicable
Segment.8.Event5	Event 5	bool	3c2e	15406	Not applicable
Segment.8.Event6	Event 6	bool	3c2f	15407	Not applicable
Segment.8.Event7	Event 7	bool	3c30	15408	Not applicable
Segment.8.Event8	Event 8	bool	3c31	15409	Not applicable
Segment.8.GoBackTo	Go back to	uint8	3c22	15394	Not applicable
Segment.8.SegmentName	Segment name	string_t	6b63	27491	Not applicable
Segment.8.Type	Type	uint8	3c10	15376	Not applicable
Segment.8.WaitFor	Wait for	uint8	3c1d	15389	Not applicable
Segment 9 For parameter values and settings (enumerations) see Segment 1					
Segment.9.Ch1Holdback	Channel 1 holdback type	uint8	3c49	15433	Not applicable
Segment.9.Ch1HoldbackVal	Channel 1 holdback value	float32	3c4b	15435	Same as Programmer.Setup.Ch1PVInput
Segment.9.Ch1PVEvent	Channel 1 PV event	uint8	3c54	15444	Not applicable
Segment.9.Ch1PVEventUse	Channel 1 PV event use	bool	3c62	15458	Not applicable
Segment.9.Ch1PVEventVal	Channel 1 PV event value	float32	3c56	15446	Same as Programmer.Setup.Ch1PVInput
Segment.9.Ch1Rate	Channel 1 rate	float32	3c46	15430	Set by Programmer.Setup.RateResolution
Segment.9.Ch1Time	Channel 1 time	time_t	3c44	15432	Set by Network.Modbus.TimeFormat
Segment.9.Ch1TSP	Channel 1 target set-point	float32	3c42	15430	Same as Programmer.Setup.Ch1PVInput
Segment.9.Ch1UserVal	Channel 1 user value	float32	3c58	15448	Same as Programmer.Setup.ResetCh1UserVal
Segment.9.Ch1Wait	Channel 1 Wait	uint8	3c4e	15434	Not applicable
Segment.9.Ch1WaitVal	Channel 1 wait value	float32	3c50	15436	Same as Programmer.Setup.PVWait1
Segment.9.Ch2Holdback	Channel 2 holdback type	uint8	3c4a	15432	Not applicable
Segment.9.Ch2HoldbackVal	Channel 2 holdback value	float32	3c4c	15434	Same as Programmer.Setup.Ch2PVInput
Segment.9.Ch2PVEvent	Channel 2 PV event	uint8	3c55	15445	Not applicable
Segment.9.Ch2PVEventUse	Channel 2 PV event use	bool	3c63	15459	Not applicable
Segment.9.Ch2PVEventVal	Channel 2 PV event value	float32	3c57	15447	Same as Programmer.Setup.Ch2PVInput
Segment.9.Ch2Rate	Channel 2 rate	float32	3c47	15431	Set by Programmer.Setup.RateResolution
Segment.9.Ch2Time	Channel 2 time	time_t	3c45	15433	Set by Network.Modbus.TimeFormat
Segment.9.Ch2TSP	Channel 2 target set-point	float32	3c43	15431	Same as Programmer.Setup.Ch2PVInput
Segment.9.Ch2UserVal	Channel 2 user value	float32	3c59	15449	Same as Programmer.Setup.ResetCh2UserVal
Segment.9.Ch2Wait	Channel 2 Wait	uint8	3c4f	15435	Not applicable
Segment.9.Ch2WaitVal	Channel 2 wait value	float32	3c51	15437	Same as Programmer.Setup.PVWait2
Segment.9.Cycles	Cycles	int16	3c53	15443	Not applicable
Segment.9.Duration	Duration	time_t	3c41	15425	Set by Network.Modbus.TimeFormat
Segment.9.EndType	End type	uint8	3c38	15400	Not applicable
Segment.9.Event1	Event 1	bool	3c5a	15450	Not applicable
Segment.9.Event2	Event 2	bool	3c5b	15451	Not applicable
Segment.9.Event3	Event 3	bool	3c5c	15452	Not applicable
Segment.9.Event4	Event 4	bool	3c5d	15453	Not applicable
Segment.9.Event5	Event 5	bool	3c5e	15454	Not applicable
Segment.9.Event6	Event 6	bool	3c5f	15455	Not applicable
Segment.9.Event7	Event 7	bool	3c60	15456	Not applicable
Segment.9.Event8	Event 8	bool	3c61	15457	Not applicable
Segment.9.GoBackTo	Go back to	uint8	3c52	15442	Not applicable
Segment.9.SegmentName	Segment name	string_t	6b79	27513	Not applicable
Segment.9.Type	Type	uint8	3c30	15392	Not applicable
Segment.9.WaitFor	Wait for	uint8	3c3d	15405	Not applicable

Parameter path	Description	Type	Hex	Dec	Resolution
Segment.9.Ch1TSP	Channel 1 target set-point	float32	3c42	15426	Same as Programmer.Setup.Ch1PVInput
Segment.9.Ch1UserVal	Channel 1 user value	float32	3c58	15448	Same as Programmer.Setup.ResetCh1UserVal
Segment.9.Ch1Wait	Channel 1 Wait	uint8	3c4e	15438	Not applicable
Segment.9.Ch1WaitVal	Channel 1 wait value	float32	3c50	15440	Same as Programmer.Setup.PVWait1
Segment.9.Ch2Holdback	Channel 2 holdback type	uint8	3c4a	15434	Not applicable
Segment.9.Ch2HoldbackVal	Channel 2 holdback value	float32	3c4c	15436	Same as Programmer.Setup.Ch2PVInput
Segment.9.Ch2PVEvent	Channel 2 PV event	uint8	3c55	15445	Not applicable
Segment.9.Ch2PVEventUse	Channel 2 PV event use	bool	3c63	15459	Not applicable
Segment.9.Ch2PVEventVal	Channel 2 PV event value	float32	3c57	15447	Same as Programmer.Setup.Ch2PVInput
Segment.9.Ch2Rate	Channel 2 rate	float32	3c47	15431	Set by Programmer.Setup.RateResolution
Segment.9.Ch2Time	Channel 2 time	time_t	3c45	15429	Set by Network.Modbus.TimeFormat
Segment.9.Ch2TSP	Channel 2 target set-point	float32	3c43	15427	Same as Programmer.Setup.Ch2PVInput
Segment.9.Ch2UserVal	Channel 2 user value	float32	3c59	15449	Same as Programmer.Setup.ResetCh2UserVal
Segment.9.Ch2Wait	Channel 2 Wait	uint8	3c4f	15439	Not applicable
Segment.9.Ch2WaitVal	Channel 2 wait value	float32	3c51	15441	Same as Programmer.Setup.PVWait2
Segment.9.Cycles	Cycles	int16	3c53	15443	Not applicable
Segment.9.Duration	Duration	time_t	3c41	15425	Set by Network.Modbus.TimeFormat
Segment.9.EndType	End type	uint8	3c48	15432	Not applicable
Segment.9.Event1	Event 1	bool	3c5a	15450	Not applicable
Segment.9.Event2	Event 2	bool	3c5b	15451	Not applicable
Segment.9.Event3	Event 3	bool	3c5c	15452	Not applicable
Segment.9.Event4	Event 4	bool	3c5d	15453	Not applicable
Segment.9.Event5	Event 5	bool	3c5e	15454	Not applicable
Segment.9.Event6	Event 6	bool	3c5f	15455	Not applicable
Segment.9.Event7	Event 7	bool	3c60	15456	Not applicable
Segment.9.Event8	Event 8	bool	3c61	15457	Not applicable
Segment.9.GoBackTo	Go back to	uint8	3c52	15442	Not applicable
Segment.9.SegmentName	Segment name	string_t	6b78	27512	Not applicable
Segment.9.Type	Type	uint8	3c40	15424	Not applicable
Segment.9.WaitFor	Wait for	uint8	3c4d	15437	Not applicable
Segment 10 For parameter values and settings (enumerations) see Segment 1					
Segment.10.Ch1Holdback	Channel 1 holdback type	uint8	3c79	15481	Not applicable
Segment.10.Ch1HoldbackVal	Channel 1 holdback value	float32	3c7b	15483	Same as Programmer.Setup.Ch1PVInput
Segment.10.Ch1PVEvent	Channel 1 PV event	uint8	3c84	15492	Not applicable
Segment.10.Ch1PVEventUse	Channel 1 PV event use	bool	3c92	15506	Not applicable
Segment.10.Ch1PVEventVal	Channel 1 PV event value	float32	3c86	15494	Same as Programmer.Setup.Ch1PVInput
Segment.10.Ch1Rate	Channel 1 rate	float32	3c76	15478	Set by Programmer.Setup.RateResolution
Segment.10.Ch1Time	Channel 1 time	time_t	3c74	15476	Set by Network.Modbus.TimeFormat
Segment.10.Ch1TSP	Channel 1 target set-point	float32	3c72	15474	Same as Programmer.Setup.Ch1PVInput
Segment.10.Ch1UserVal	Channel 1 user value	float32	3c88	15496	Same as Programmer.Setup.ResetCh1UserVal
Segment.10.Ch1Wait	Channel 1 Wait	uint8	3c7e	15486	Not applicable
Segment.10.Ch1WaitVal	Channel 1 wait value	float32	3c80	15488	Same as Programmer.Setup.PVWait1
Segment.10.Ch2Holdback	Channel 2 holdback type	uint8	3c7a	15482	Not applicable
Segment.10.Ch2HoldbackVal	Channel 2 holdback value	float32	3c7c	15484	Same as Programmer.Setup.Ch2PVInput
Segment.10.Ch2PVEvent	Channel 2 PV event	uint8	3c85	15493	Not applicable
Segment.10.Ch2PVEventUse	Channel 2 PV event use	bool	3c93	15507	Not applicable
Segment.10.Ch2PVEventVal	Channel 2 PV event value	float32	3c87	15495	Same as Programmer.Setup.Ch2PVInput
Segment.10.Ch2Rate	Channel 2 rate	float32	3c77	15479	Set by Programmer.Setup.RateResolution
Segment.10.Ch2Time	Channel 2 time	time_t	3c75	15477	Set by Network.Modbus.TimeFormat
Segment.10.Ch2TSP	Channel 2 target set-point	float32	3c73	15475	Same as Programmer.Setup.Ch2PVInput
Segment.10.Ch2UserVal	Channel 2 user value	float32	3c89	15497	Same as Programmer.Setup.ResetCh2UserVal
Segment.10.Ch2Wait	Channel 2 Wait	uint8	3c7f	15487	Not applicable
Segment.10.Ch2WaitVal	Channel 2 wait value	float32	3c81	15489	Same as Programmer.Setup.PVWait2
Segment.10.Cycles	Cycles	int16	3c83	15491	Not applicable
Segment.10.Duration	Duration	time_t	3c71	15473	Set by Network.Modbus.TimeFormat
Segment.10.EndType	End type	uint8	3c78	15480	Not applicable
Segment.10.Event1	Event 1	bool	3c8a	15498	Not applicable
Segment.10.Event2	Event 2	bool	3c8b	15499	Not applicable

Parameter path	Description	Type	Hex	Dec	Resolution
Segment.10.Event4	Event 4	bool	3c8d	15501	Not applicable
Segment.10.Event5	Event 5	bool	3c8e	15502	Not applicable
Segment.10.Event6	Event 6	bool	3c8f	15503	Not applicable
Segment.10.Event7	Event 7	bool	3c90	15504	Not applicable
Segment.10.Event8	Event 8	bool	3c91	15505	Not applicable
Segment.10.GoBackTo	Go back to	uint8	3c82	15490	Not applicable
Segment.10.SegmentName	Segment name	string_t	6b8d	27533	Not applicable
Segment.10.Type	Type	uint8	3c70	15472	Not applicable
Segment.10.WaitFor	Wait for	uint8	3c7d	15485	Not applicable
Segment 11 For parameter values and settings (enumerations) see Segment 1					
Segment.11.Ch1Holdback	Channel 1 holdback type	uint8	3ca9	15529	Not applicable
Segment.11.Ch1HoldbackVal	Channel 1 holdback value	float32	3cab	15531	Same as Programmer.Setup.Ch1PVInput
Segment.11.Ch1PVEvent	Channel 1 PV event	uint8	3cb4	15540	Not applicable
Segment.11.Ch1PVEventUse	Channel 1 PV event use	bool	3cc2	15554	Not applicable
Segment.11.Ch1PVEventVal	Channel 1 PV event value	float32	3cb6	15542	Same as Programmer.Setup.Ch1PVInput
Segment.11.Ch1Rate	Channel 1 rate	float32	3ca6	15526	Set by Programmer.Setup.RateResolution
Segment.11.Ch1Time	Channel 1 time	time_t	3ca4	15524	Set by Network.Modbus.TimeFormat
Segment.11.Ch1TSP	Channel 1 target set-point	float32	3ca2	15522	Same as Programmer.Setup.Ch1PVInput
Segment.11.Ch1UserVal	Channel 1 user value	float32	3cb8	15544	Same as Programmer.Setup.ResetCh1UserVal
Segment.11.Ch1Wait	Channel 1 Wait	uint8	3cae	15534	Not applicable
Segment.11.Ch1WaitVal	Channel 1 wait value	float32	3cb0	15536	Same as Programmer.Setup.PVWait1
Segment.11.Ch2Holdback	Channel 2 holdback type	uint8	3caa	15530	Not applicable
Segment.11.Ch2HoldbackVal	Channel 2 holdback value	float32	3cac	15532	Same as Programmer.Setup.Ch2PVInput
Segment.11.Ch2PVEvent	Channel 2 PV event	uint8	3cb5	15541	Not applicable
Segment.11.Ch2PVEventUse	Channel 2 PV event use	bool	3cc3	15555	Not applicable
Segment.11.Ch2PVEventVal	Channel 2 PV event value	float32	3cb7	15543	Same as Programmer.Setup.Ch2PVInput
Segment.11.Ch2Rate	Channel 2 rate	float32	3ca7	15527	Set by Programmer.Setup.RateResolution
Segment.11.Ch2Time	Channel 2 time	time_t	3ca5	15525	Set by Network.Modbus.TimeFormat
Segment.11.Ch2TSP	Channel 2 target set-point	float32	3ca3	15523	Same as Programmer.Setup.Ch2PVInput
Segment.11.Ch2UserVal	Channel 2 user value	float32	3cb9	15545	Same as Programmer.Setup.ResetCh2UserVal
Segment.11.Ch2Wait	Channel 2 Wait	uint8	3caf	15535	Not applicable
Segment.11.Ch2WaitVal	Channel 2 wait value	float32	3cb1	15537	Same as Programmer.Setup.PVWait2
Segment.11.Cycles	Cycles	int16	3cb3	15539	Not applicable
Segment.11.Duration	Duration	time_t	3ca1	15521	Set by Network.Modbus.TimeFormat
Segment.11.EndType	End type	uint8	3ca8	15528	Not applicable
Segment.11.Event1	Event 1	bool	3cba	15546	Not applicable
Segment.11.Event2	Event 2	bool	3cbb	15547	Not applicable
Segment.11.Event3	Event 3	bool	3cbc	15548	Not applicable
Segment.11.Event4	Event 4	bool	3cbd	15549	Not applicable
Segment.11.Event5	Event 5	bool	3cbe	15550	Not applicable
Segment.11.Event6	Event 6	bool	3cbf	15551	Not applicable
Segment.11.Event7	Event 7	bool	3cc0	15552	Not applicable
Segment.11.Event8	Event 8	bool	3cc1	15553	Not applicable
Segment.11.GoBackTo	Go back to	uint8	3cb2	15538	Not applicable
Segment.11.SegmentName	Segment name	string_t	6ba2	27554	Not applicable
Segment.11.Type	Type	uint8	3ca0	15520	Not applicable
Segment.11.WaitFor	Wait for	uint8	3cad	15533	Not applicable
Segment 12 For parameter values and settings (enumerations) see Segment 1					
Segment.12.Ch1Holdback	Channel 1 holdback type	uint8	3cd9	15577	Not applicable
Segment.12.Ch1HoldbackVal	Channel 1 holdback value	float32	3cdb	15579	Same as Programmer.Setup.Ch1PVInput
Segment.12.Ch1PVEvent	Channel 1 PV event	uint8	3ce4	15588	Not applicable
Segment.12.Ch1PVEventUse	Channel 1 PV event use	bool	3cf2	15602	Not applicable
Segment.12.Ch1PVEventVal	Channel 1 PV event value	float32	3ce6	15590	Same as Programmer.Setup.Ch1PVInput
Segment.12.Ch1Rate	Channel 1 rate	float32	3cd6	15574	Set by Programmer.Setup.RateResolution
Segment.12.Ch1Time	Channel 1 time	time_t	3cd4	15572	Set by Network.Modbus.TimeFormat
Segment.12.Ch1TSP	Channel 1 target set-point	float32	3cd2	15570	Same as Programmer.Setup.Ch1PVInput
Segment.12.Ch1UserVal	Channel 1 user value	float32	3ce8	15592	Same as Programmer.Setup.ResetCh1UserVal

Parameter path	Description	Type	Hex	Dec	Resolution
Segment.12.Ch1WaitVal	Channel 1 wait value	float32	3ce0	15584	Same as Programmer.Setup.PVWait1
Segment.12.Ch2Holdback	Channel 2 holdback type	uint8	3cda	15578	Not applicable
Segment.12.Ch2HoldbackVal	Channel 2 holdback value	float32	3cdc	15580	Same as Programmer.Setup.Ch2PVInput
Segment.12.Ch2PVEvent	Channel 2 PV event	uint8	3ce5	15589	Not applicable
Segment.12.Ch2PVEventUse	Channel 2 PV event use	bool	3cf3	15603	Not applicable
Segment.12.Ch2PVEventVal	Channel 2 PV event value	float32	3ce7	15591	Same as Programmer.Setup.Ch2PVInput
Segment.12.Ch2Rate	Channel 2 rate	float32	3cd7	15575	Set by Programmer.Setup.RateResolution
Segment.12.Ch2Time	Channel 2 time	time_t	3cd5	15573	Set by Network.Modbus.TimeFormat
Segment.12.Ch2TSP	Channel 2 target set-point	float32	3cd3	15571	Same as Programmer.Setup.Ch2PVInput
Segment.12.Ch2UserVal	Channel 2 user value	float32	3ce9	15593	Same as Programmer.Setup.ResetCh2UserVal
Segment.12.Ch2Wait	Channel 2 Wait	uint8	3cdf	15583	Not applicable
Segment.12.Ch2WaitVal	Channel 2 wait value	float32	3ce1	15585	Same as Programmer.Setup.PVWait2
Segment.12.Cycles	Cycles	int16	3ce3	15587	Not applicable
Segment.12.Duration	Duration	time_t	3cd1	15569	Set by Network.Modbus.TimeFormat
Segment.12.EndType	End type	uint8	3cd8	15576	Not applicable
Segment.12.Event1	Event 1	bool	3cea	15594	Not applicable
Segment.12.Event2	Event 2	bool	3ceb	15595	Not applicable
Segment.12.Event3	Event 3	bool	3cec	15596	Not applicable
Segment.12.Event4	Event 4	bool	3ced	15597	Not applicable
Segment.12.Event5	Event 5	bool	3cee	15598	Not applicable
Segment.12.Event6	Event 6	bool	3cef	15599	Not applicable
Segment.12.Event7	Event 7	bool	3cf0	15600	Not applicable
Segment.12.Event8	Event 8	bool	3cf1	15601	Not applicable
Segment.12.GoBackTo	Go back to	uint8	3ce2	15586	Not applicable
Segment.12.SegmentName	Segment name	string_t	6bb7	27575	Not applicable
Segment.12.Type	Type	uint8	3cd0	15568	Not applicable
Segment.12.WaitFor	Wait for	uint8	3cdd	15581	Not applicable
Segment 13 For parameter values and settings (enumerations) see Segment 1					
Segment.13.Ch1Holdback	Channel 1 holdback type	uint8	3d09	15625	Not applicable
Segment.13.Ch1HoldbackVal	Channel 1 holdback value	float32	3d0b	15627	Same as Programmer.Setup.Ch1PVInput
Segment.13.Ch1PVEvent	Channel 1 PV event	uint8	3d14	15636	Not applicable
Segment.13.Ch1PVEventUse	Channel 1 PV event use	bool	3d22	15650	Not applicable
Segment.13.Ch1PVEventVal	Channel 1 PV event value	float32	3d16	15638	Same as Programmer.Setup.Ch1PVInput
Segment.13.Ch1Rate	Channel 1 rate	float32	3d06	15622	Set by Programmer.Setup.RateResolution
Segment.13.Ch1Time	Channel 1 time	time_t	3d04	15620	Set by Network.Modbus.TimeFormat
Segment.13.Ch1TSP	Channel 1 target set-point	float32	3d02	15618	Same as Programmer.Setup.Ch1PVInput
Segment.13.Ch1UserVal	Channel 1 user value	float32	3d18	15640	Same as Programmer.Setup.ResetCh1UserVal
Segment.13.Ch1Wait	Channel 1 Wait	uint8	3d0e	15630	Not applicable
Segment.13.Ch1WaitVal	Channel 1 wait value	float32	3d10	15632	Same as Programmer.Setup.PVWait1
Segment.13.Ch2Holdback	Channel 2 holdback type	uint8	3d0a	15626	Not applicable
Segment.13.Ch2HoldbackVal	Channel 2 holdback value	float32	3d0c	15628	Same as Programmer.Setup.Ch2PVInput
Segment.13.Ch2PVEvent	Channel 2 PV event	uint8	3d15	15637	Not applicable
Segment.13.Ch2PVEventUse	Channel 2 PV event use	bool	3d23	15651	Not applicable
Segment.13.Ch2PVEventVal	Channel 2 PV event value	float32	3d17	15639	Same as Programmer.Setup.Ch2PVInput
Segment.13.Ch2Rate	Channel 2 rate	float32	3d07	15623	Set by Programmer.Setup.RateResolution
Segment.13.Ch2Time	Channel 2 time	time_t	3d05	15621	Set by Network.Modbus.TimeFormat
Segment.13.Ch2TSP	Channel 2 target set-point	float32	3d03	15619	Same as Programmer.Setup.Ch2PVInput
Segment.13.Ch2UserVal	Channel 2 user value	float32	3d19	15641	Same as Programmer.Setup.ResetCh2UserVal
Segment.13.Ch2Wait	Channel 2 Wait	uint8	3d0f	15631	Not applicable
Segment.13.Ch2WaitVal	Channel 2 wait value	float32	3d11	15633	Same as Programmer.Setup.PVWait2
Segment.13.Cycles	Cycles	int16	3d13	15635	Not applicable
Segment.13.Duration	Duration	time_t	3d01	15617	Set by Network.Modbus.TimeFormat
Segment.13.EndType	End type	uint8	3d08	15624	Not applicable
Segment.13.Event1	Event 1	bool	3d1a	15642	Not applicable
Segment.13.Event2	Event 2	bool	3d1b	15643	Not applicable
Segment.13.Event3	Event 3	bool	3d1c	15644	Not applicable
Segment.13.Event4	Event 4	bool	3d1d	15645	Not applicable
Segment.13.Event5	Event 5	bool	3d1e	15646	Not applicable

Parameter path	Description	Type	Hex	Dec	Resolution
Segment.13.Event7	Event 7	bool	3d20	15648	Not applicable
Segment.13.Event8	Event 8	bool	3d21	15649	Not applicable
Segment.13.GoBackTo	Go back to	uint8	3d12	15634	Not applicable
Segment.13.SegmentName	Segment name	string_t	6bcc	27596	Not applicable
Segment.13.Type	Type	uint8	3d00	15616	Not applicable
Segment.13.WaitFor	Wait for	uint8	3d0d	15629	Not applicable
Segment 14 For parameter values and settings (enumerations) see Segment 1					
Segment.14.Ch1Holdback	Channel 1 holdback type	uint8	3d39	15673	Not applicable
Segment.14.Ch1HoldbackVal	Channel 1 holdback value	float32	3d3b	15675	Same as Programmer.Setup.Ch1PVInput
Segment.14.Ch1PVEvent	Channel 1 PV event	uint8	3d44	15684	Not applicable
Segment.14.Ch1PVEventUse	Channel 1 PV event use	bool	3d52	15698	Not applicable
Segment.14.Ch1PVEventVal	Channel 1 PV event value	float32	3d46	15686	Same as Programmer.Setup.Ch1PVInput
Segment.14.Ch1Rate	Channel 1 rate	float32	3d36	15670	Set by Programmer.Setup.RateResolution
Segment.14.Ch1Time	Channel 1 time	time_t	3d34	15668	Set by Network.Modbus.TimeFormat
Segment.14.Ch1TSP	Channel 1 target set-point	float32	3d32	15666	Same as Programmer.Setup.Ch1PVInput
Segment.14.Ch1UserVal	Channel 1 user value	float32	3d48	15688	Same as Programmer.Setup.ResetCh1UserVal
Segment.14.Ch1Wait	Channel 1 Wait	uint8	3d3e	15678	Not applicable
Segment.14.Ch1WaitVal	Channel 1 wait value	float32	3d40	15680	Same as Programmer.Setup.PVWait1
Segment.14.Ch2Holdback	Channel 2 holdback type	uint8	3d3a	15674	Not applicable
Segment.14.Ch2HoldbackVal	Channel 2 holdback value	float32	3d3c	15676	Same as Programmer.Setup.Ch2PVInput
Segment.14.Ch2PVEvent	Channel 2 PV event	uint8	3d45	15685	Not applicable
Segment.14.Ch2PVEventUse	Channel 2 PV event use	bool	3d53	15699	Not applicable
Segment.14.Ch2PVEventVal	Channel 2 PV event value	float32	3d47	15687	Same as Programmer.Setup.Ch2PVInput
Segment.14.Ch2Rate	Channel 2 rate	float32	3d37	15671	Set by Programmer.Setup.RateResolution
Segment.14.Ch2Time	Channel 2 time	time_t	3d35	15669	Set by Network.Modbus.TimeFormat
Segment.14.Ch2TSP	Channel 2 target set-point	float32	3d33	15667	Same as Programmer.Setup.Ch2PVInput
Segment.14.Ch2UserVal	Channel 2 user value	float32	3d49	15689	Same as Programmer.Setup.ResetCh2UserVal
Segment.14.Ch2Wait	Channel 2 Wait	uint8	3d3f	15679	Not applicable
Segment.14.Ch2WaitVal	Channel 2 wait value	float32	3d41	15681	Same as Programmer.Setup.PVWait2
Segment.14.Cycles	Cycles	int16	3d43	15683	Not applicable
Segment.14.Duration	Duration	time_t	3d31	15665	Set by Network.Modbus.TimeFormat
Segment.14.EndType	End type	uint8	3d38	15672	Not applicable
Segment.14.Event1	Event 1	bool	3d4a	15690	Not applicable
Segment.14.Event2	Event 2	bool	3d4b	15691	Not applicable
Segment.14.Event3	Event 3	bool	3d4c	15692	Not applicable
Segment.14.Event4	Event 4	bool	3d4d	15693	Not applicable
Segment.14.Event5	Event 5	bool	3d4e	15694	Not applicable
Segment.14.Event6	Event 6	bool	3d4f	15695	Not applicable
Segment.14.Event7	Event 7	bool	3d50	15696	Not applicable
Segment.14.Event8	Event 8	bool	3d51	15697	Not applicable
Segment.14.GoBackTo	Go back to	uint8	3d42	15682	Not applicable
Segment.14.SegmentName	Segment name	string_t	6be1	27617	Not applicable
Segment.14.Type	Type	uint8	3d30	15664	Not applicable
Segment.14.WaitFor	Wait for	uint8	3d3d	15677	Not applicable
Segment 15 For parameter values and settings (enumerations) see Segment 1					
Segment.15.Ch1Holdback	Channel 1 holdback type	uint8	3d69	15721	Not applicable
Segment.15.Ch1HoldbackVal	Channel 1 holdback value	float32	3d6b	15723	Same as Programmer.Setup.Ch1PVInput
Segment.15.Ch1PVEvent	Channel 1 PV event	uint8	3d74	15732	Not applicable
Segment.15.Ch1PVEventUse	Channel 1 PV event use	bool	3d82	15746	Not applicable
Segment.15.Ch1PVEventVal	Channel 1 PV event value	float32	3d76	15734	Same as Programmer.Setup.Ch1PVInput
Segment.15.Ch1Rate	Channel 1 rate	float32	3d66	15718	Set by Programmer.Setup.RateResolution
Segment.15.Ch1Time	Channel 1 time	time_t	3d64	15716	Set by Network.Modbus.TimeFormat
Segment.15.Ch1TSP	Channel 1 target set-point	float32	3d62	15714	Same as Programmer.Setup.Ch1PVInput
Segment.15.Ch1UserVal	Channel 1 user value	float32	3d78	15736	Same as Programmer.Setup.ResetCh1UserVal
Segment.15.Ch1Wait	Channel 1 Wait	uint8	3d6e	15726	Not applicable
Segment.15.Ch1WaitVal	Channel 1 wait value	float32	3d70	15728	Same as Programmer.Setup.PVWait1
Segment.15.Ch2Holdback	Channel 2 holdback type	uint8	3d6a	15722	Not applicable

Parameter path	Description	Type	Hex	Dec	Resolution
Segment.15.Ch2PVEvent	Channel 2 PV event	uint8	3d75	15733	Not applicable
Segment.15.Ch2PVEventUse	Channel 2 PV event use	bool	3d83	15747	Not applicable
Segment.15.Ch2PVEventVal	Channel 2 PV event value	float32	3d77	15735	Same as Programmer.Setup.Ch2PVInput
Segment.15.Ch2Rate	Channel 2 rate	float32	3d67	15719	Set by Programmer.Setup.RateResolution
Segment.15.Ch2Time	Channel 2 time	time_t	3d65	15717	Set by Network.Modbus.TimeFormat
Segment.15.Ch2TSP	Channel 2 target set-point	float32	3d63	15715	Same as Programmer.Setup.Ch2PVInput
Segment.15.Ch2UserVal	Channel 2 user value	float32	3d79	15737	Same as Programmer.Setup.ResetCh2UserVal
Segment.15.Ch2Wait	Channel 2 Wait	uint8	3d6f	15727	Not applicable
Segment.15.Ch2WaitVal	Channel 2 wait value	float32	3d71	15729	Same as Programmer.Setup.PVWait2
Segment.15.Cycles	Cycles	int16	3d73	15731	Not applicable
Segment.15.Duration	Duration	time_t	3d61	15713	Set by Network.Modbus.TimeFormat
Segment.15.EndType	End type	uint8	3d68	15720	Not applicable
Segment.15.Event1	Event 1	bool	3d7a	15738	Not applicable
Segment.15.Event2	Event 2	bool	3d7b	15739	Not applicable
Segment.15.Event3	Event 3	bool	3d7c	15740	Not applicable
Segment.15.Event4	Event 4	bool	3d7d	15741	Not applicable
Segment.15.Event5	Event 5	bool	3d7e	15742	Not applicable
Segment.15.Event6	Event 6	bool	3d7f	15743	Not applicable
Segment.15.Event7	Event 7	bool	3d80	15744	Not applicable
Segment.15.Event8	Event 8	bool	3d81	15745	Not applicable
Segment.15.GoBackTo	Go back to	uint8	3d72	15730	Not applicable
Segment.15.SegmentName	Segment name	string_t	6bf6	27638	Not applicable
Segment.15.Type	Type	uint8	3d60	15712	Not applicable
Segment.15.WaitFor	Wait for	uint8	3d6d	15725	Not applicable
Segment 16 For parameter values and settings (enumerations) see Segment 1					
Segment.16.Ch1Holdback	Channel 1 holdback type	uint8	3d99	15769	Not applicable
Segment.16.Ch1HoldbackVal	Channel 1 holdback value	float32	3d9b	15771	Same as Programmer.Setup.Ch1PVInput
Segment.16.Ch1PVEvent	Channel 1 PV event	uint8	3da4	15780	Not applicable
Segment.16.Ch1PVEventUse	Channel 1 PV event use	bool	3db2	15794	Not applicable
Segment.16.Ch1PVEventVal	Channel 1 PV event value	float32	3da6	15782	Same as Programmer.Setup.Ch1PVInput
Segment.16.Ch1Rate	Channel 1 rate	float32	3d96	15766	Set by Programmer.Setup.RateResolution
Segment.16.Ch1Time	Channel 1 time	time_t	3d94	15764	Set by Network.Modbus.TimeFormat
Segment.16.Ch1TSP	Channel 1 target set-point	float32	3d92	15762	Same as Programmer.Setup.Ch1PVInput
Segment.16.Ch1UserVal	Channel 1 user value	float32	3da8	15784	Same as Programmer.Setup.ResetCh1UserVal
Segment.16.Ch1Wait	Channel 1 Wait	uint8	3d9e	15774	Not applicable
Segment.16.Ch1WaitVal	Channel 1 wait value	float32	3da0	15776	Same as Programmer.Setup.PVWait1
Segment.16.Ch2Holdback	Channel 2 holdback type	uint8	3d9a	15770	Not applicable
Segment.16.Ch2HoldbackVal	Channel 2 holdback value	float32	3d9c	15772	Same as Programmer.Setup.Ch2PVInput
Segment.16.Ch2PVEvent	Channel 2 PV event	uint8	3da5	15781	Not applicable
Segment.16.Ch2PVEventUse	Channel 2 PV event use	bool	3db3	15795	Not applicable
Segment.16.Ch2PVEventVal	Channel 2 PV event value	float32	3da7	15783	Same as Programmer.Setup.Ch2PVInput
Segment.16.Ch2Rate	Channel 2 rate	float32	3d97	15767	Set by Programmer.Setup.RateResolution
Segment.16.Ch2Time	Channel 2 time	time_t	3d95	15765	Set by Network.Modbus.TimeFormat
Segment.16.Ch2TSP	Channel 2 target set-point	float32	3d93	15763	Same as Programmer.Setup.Ch2PVInput
Segment.16.Ch2UserVal	Channel 2 user value	float32	3da9	15785	Same as Programmer.Setup.ResetCh2UserVal
Segment.16.Ch2Wait	Channel 2 Wait	uint8	3d9f	15775	Not applicable
Segment.16.Ch2WaitVal	Channel 2 wait value	float32	3da1	15777	Same as Programmer.Setup.PVWait2
Segment.16.Cycles	Cycles	int16	3da3	15779	Not applicable
Segment.16.Duration	Duration	time_t	3d91	15761	Set by Network.Modbus.TimeFormat
Segment.16.EndType	End type	uint8	3d98	15768	Not applicable
Segment.16.Event1	Event 1	bool	3daa	15786	Not applicable
Segment.16.Event2	Event 2	bool	3dab	15787	Not applicable
Segment.16.Event3	Event 3	bool	3dac	15788	Not applicable
Segment.16.Event4	Event 4	bool	3dad	15789	Not applicable
Segment.16.Event5	Event 5	bool	3dae	15790	Not applicable
Segment.16.Event6	Event 6	bool	3daf	15791	Not applicable
Segment.16.Event7	Event 7	bool	3db0	15792	Not applicable
Segment.16.Event8	Event 8	bool	3db1	15793	Not applicable

Parameter path	Description	Type	Hex	Dec	Resolution
Segment.16.SegmentName	Segment name	string_t	6c0b	27659	Not applicable
Segment.16.Type	Type	uint8	3d90	15760	Not applicable
Segment.16.WaitFor	Wait for	uint8	3d9d	15773	Not applicable
Segment 17 For parameter values and settings (enumerations) see Segment 1					
Segment.17.Ch1Holdback	Channel 1 holdback type	uint8	3dc9	15817	Not applicable
Segment.17.Ch1HoldbackVal	Channel 1 holdback value	float32	3dcb	15819	Same as Programmer.Setup.Ch1PVInput
Segment.17.Ch1PVEvent	Channel 1 PV event	uint8	3dd4	15828	Not applicable
Segment.17.Ch1PVEventUse	Channel 1 PV event use	bool	3de2	15842	Not applicable
Segment.17.Ch1PVEventVal	Channel 1 PV event value	float32	3dd6	15830	Same as Programmer.Setup.Ch1PVInput
Segment.17.Ch1Rate	Channel 1 rate	float32	3dc6	15814	Set by Programmer.Setup.RateResolution
Segment.17.Ch1Time	Channel 1 time	time_t	3dc4	15812	Set by Network.Modbus.TimeFormat
Segment.17.Ch1TSP	Channel 1 target set-point	float32	3dc2	15810	Same as Programmer.Setup.Ch1PVInput
Segment.17.Ch1UserVal	Channel 1 user value	float32	3dd8	15832	Same as Programmer.Setup.ResetCh1UserVal
Segment.17.Ch1Wait	Channel 1 Wait	uint8	3dce	15822	Not applicable
Segment.17.Ch1WaitVal	Channel 1 wait value	float32	3dd0	15824	Same as Programmer.Setup.PVWait1
Segment.17.Ch2Holdback	Channel 2 holdback type	uint8	3dca	15818	Not applicable
Segment.17.Ch2HoldbackVal	Channel 2 holdback value	float32	3dcc	15820	Same as Programmer.Setup.Ch2PVInput
Segment.17.Ch2PVEvent	Channel 2 PV event	uint8	3dd5	15829	Not applicable
Segment.17.Ch2PVEventUse	Channel 2 PV event use	bool	3de3	15843	Not applicable
Segment.17.Ch2PVEventVal	Channel 2 PV event value	float32	3dd7	15831	Same as Programmer.Setup.Ch2PVInput
Segment.17.Ch2Rate	Channel 2 rate	float32	3dc7	15815	Set by Programmer.Setup.RateResolution
Segment.17.Ch2Time	Channel 2 time	time_t	3dc5	15813	Set by Network.Modbus.TimeFormat
Segment.17.Ch2TSP	Channel 2 target set-point	float32	3dc3	15811	Same as Programmer.Setup.Ch2PVInput
Segment.17.Ch2UserVal	Channel 2 user value	float32	3dd9	15833	Same as Programmer.Setup.ResetCh2UserVal
Segment.17.Ch2Wait	Channel 2 Wait	uint8	3dcf	15823	Not applicable
Segment.17.Ch2WaitVal	Channel 2 wait value	float32	3dd1	15825	Same as Programmer.Setup.PVWait2
Segment.17.Cycles	Cycles	int16	3dd3	15827	Not applicable
Segment.17.Duration	Duration	time_t	3dc1	15809	Set by Network.Modbus.TimeFormat
Segment.17.EndType	End type	uint8	3dc8	15816	Not applicable
Segment.17.Event1	Event 1	bool	3dda	15834	Not applicable
Segment.17.Event2	Event 2	bool	3ddb	15835	Not applicable
Segment.17.Event3	Event 3	bool	3ddc	15836	Not applicable
Segment.17.Event4	Event 4	bool	3ddd	15837	Not applicable
Segment.17.Event5	Event 5	bool	3dde	15838	Not applicable
Segment.17.Event6	Event 6	bool	3ddf	15839	Not applicable
Segment.17.Event7	Event 7	bool	3de0	15840	Not applicable
Segment.17.Event8	Event 8	bool	3de1	15841	Not applicable
Segment.17.GoBackTo	Go back to	uint8	3dd2	15826	Not applicable
Segment.17.SegmentName	Segment name	string_t	6c20	27680	Not applicable
Segment.17.Type	Type	uint8	3dc0	15808	Not applicable
Segment.17.WaitFor	Wait for	uint8	3dcd	15821	Not applicable
Segment 18 For parameter values and settings (enumerations) see Segment 1					
Segment.18.Ch1Holdback	Channel 1 holdback type	uint8	3df9	15865	Not applicable
Segment.18.Ch1HoldbackVal	Channel 1 holdback value	float32	3dfb	15867	Same as Programmer.Setup.Ch1PVInput
Segment.18.Ch1PVEvent	Channel 1 PV event	uint8	3e04	15876	Not applicable
Segment.18.Ch1PVEventUse	Channel 1 PV event use	bool	3e12	15890	Not applicable
Segment.18.Ch1PVEventVal	Channel 1 PV event value	float32	3e06	15878	Same as Programmer.Setup.Ch1PVInput
Segment.18.Ch1Rate	Channel 1 rate	float32	3df6	15862	Set by Programmer.Setup.RateResolution
Segment.18.Ch1Time	Channel 1 time	time_t	3df4	15860	Set by Network.Modbus.TimeFormat
Segment.18.Ch1TSP	Channel 1 target set-point	float32	3df2	15858	Same as Programmer.Setup.Ch1PVInput
Segment.18.Ch1UserVal	Channel 1 user value	float32	3e08	15880	Same as Programmer.Setup.ResetCh1UserVal
Segment.18.Ch1Wait	Channel 1 Wait	uint8	3dfe	15870	Not applicable
Segment.18.Ch1WaitVal	Channel 1 wait value	float32	3e00	15872	Same as Programmer.Setup.PVWait1
Segment.18.Ch2Holdback	Channel 2 holdback type	uint8	3dfa	15866	Not applicable
Segment.18.Ch2HoldbackVal	Channel 2 holdback value	float32	3dfc	15868	Same as Programmer.Setup.Ch2PVInput
Segment.18.Ch2PVEvent	Channel 2 PV event	uint8	3e05	15877	Not applicable
Segment.18.Ch2PVEventUse	Channel 2 PV event use	bool	3e13	15891	Not applicable

Parameter path	Description	Type	Hex	Dec	Resolution
Segment.18.Ch2Rate	Channel 2 rate	float32	3df7	15863	Set by Programmer.Setup.RateResolution
Segment.18.Ch2Time	Channel 2 time	time_t	3df5	15861	Set by Network.Modbus.TimeFormat
Segment.18.Ch2TSP	Channel 2 target set-point	float32	3df3	15859	Same as Programmer.Setup.Ch2PVInput
Segment.18.Ch2UserVal	Channel 2 user value	float32	3e09	15881	Same as Programmer.Setup.ResetCh2UserVal
Segment.18.Ch2Wait	Channel 2 Wait	uint8	3dff	15871	Not applicable
Segment.18.Ch2WaitVal	Channel 2 wait value	float32	3e01	15873	Same as Programmer.Setup.PVWait2
Segment.18.Cycles	Cycles	int16	3e03	15875	Not applicable
Segment.18.Duration	Duration	time_t	3df1	15857	Set by Network.Modbus.TimeFormat
Segment.18.EndType	End type	uint8	3df8	15864	Not applicable
Segment.18.Event1	Event 1	bool	3e0a	15882	Not applicable
Segment.18.Event2	Event 2	bool	3e0b	15883	Not applicable
Segment.18.Event3	Event 3	bool	3e0c	15884	Not applicable
Segment.18.Event4	Event 4	bool	3e0d	15885	Not applicable
Segment.18.Event5	Event 5	bool	3e0e	15886	Not applicable
Segment.18.Event6	Event 6	bool	3e0f	15887	Not applicable
Segment.18.Event7	Event 7	bool	3e10	15888	Not applicable
Segment.18.Event8	Event 8	bool	3e11	15889	Not applicable
Segment.18.GoBackTo	Go back to	uint8	3e02	15874	Not applicable
Segment.18.SegmentName	Segment name	string_t	6c35	27701	Not applicable
Segment.18.Type	Type	uint8	3df0	15856	Not applicable
Segment.18.WaitFor	Wait for	uint8	3dfd	15869	Not applicable
Segment 19 For parameter values and settings (enumerations) see Segment 1					
Segment.19.Ch1Holdback	Channel 1 holdback type	uint8	3e29	15913	Not applicable
Segment.19.Ch1HoldbackVal	Channel 1 holdback value	float32	3e2b	15915	Same as Programmer.Setup.Ch1PVInput
Segment.19.Ch1PVEvent	Channel 1 PV event	uint8	3e34	15924	Not applicable
Segment.19.Ch1PVEventUse	Channel 1 PV event use	bool	3e42	15938	Not applicable
Segment.19.Ch1PVEventVal	Channel 1 PV event value	float32	3e36	15926	Same as Programmer.Setup.Ch1PVInput
Segment.19.Ch1Rate	Channel 1 rate	float32	3e26	15910	Set by Programmer.Setup.RateResolution
Segment.19.Ch1Time	Channel 1 time	time_t	3e24	15908	Set by Network.Modbus.TimeFormat
Segment.19.Ch1TSP	Channel 1 target set-point	float32	3e22	15906	Same as Programmer.Setup.Ch1PVInput
Segment.19.Ch1UserVal	Channel 1 user value	float32	3e38	15928	Same as Programmer.Setup.ResetCh1UserVal
Segment.19.Ch1Wait	Channel 1 Wait	uint8	3e2e	15918	Not applicable
Segment.19.Ch1WaitVal	Channel 1 wait value	float32	3e30	15920	Same as Programmer.Setup.PVWait1
Segment.19.Ch2Holdback	Channel 2 holdback type	uint8	3e2a	15914	Not applicable
Segment.19.Ch2HoldbackVal	Channel 2 holdback value	float32	3e2c	15916	Same as Programmer.Setup.Ch2PVInput
Segment.19.Ch2PVEvent	Channel 2 PV event	uint8	3e35	15925	Not applicable
Segment.19.Ch2PVEventUse	Channel 2 PV event use	bool	3e43	15939	Not applicable
Segment.19.Ch2PVEventVal	Channel 2 PV event value	float32	3e37	15927	Same as Programmer.Setup.Ch2PVInput
Segment.19.Ch2Rate	Channel 2 rate	float32	3e27	15911	Set by Programmer.Setup.RateResolution
Segment.19.Ch2Time	Channel 2 time	time_t	3e25	15909	Set by Network.Modbus.TimeFormat
Segment.19.Ch2TSP	Channel 2 target set-point	float32	3e23	15907	Same as Programmer.Setup.Ch2PVInput
Segment.19.Ch2UserVal	Channel 2 user value	float32	3e39	15929	Same as Programmer.Setup.ResetCh2UserVal
Segment.19.Ch2Wait	Channel 2 Wait	uint8	3e2f	15919	Not applicable
Segment.19.Ch2WaitVal	Channel 2 wait value	float32	3e31	15921	Same as Programmer.Setup.PVWait2
Segment.19.Cycles	Cycles	int16	3e33	15923	Not applicable
Segment.19.Duration	Duration	time_t	3e21	15905	Set by Network.Modbus.TimeFormat
Segment.19.EndType	End type	uint8	3e28	15912	Not applicable
Segment.19.Event1	Event 1	bool	3e3a	15930	Not applicable
Segment.19.Event2	Event 2	bool	3e3b	15931	Not applicable
Segment.19.Event3	Event 3	bool	3e3c	15932	Not applicable
Segment.19.Event4	Event 4	bool	3e3d	15933	Not applicable
Segment.19.Event5	Event 5	bool	3e3e	15934	Not applicable
Segment.19.Event6	Event 6	bool	3e3f	15935	Not applicable
Segment.19.Event7	Event 7	bool	3e40	15936	Not applicable
Segment.19.Event8	Event 8	bool	3e41	15937	Not applicable
Segment.19.GoBackTo	Go back to	uint8	3e32	15922	Not applicable
Segment.19.SegmentName	Segment name	string_t	6c4a	27722	Not applicable
Segment.19.Type	Type	uint8	3e20	15904	Not applicable

Parameter path	Description	Type	Hex	Dec	Resolution
Segment 20 For parameter values and settings (enumerations) see Segment 1					
Segment.20.Ch1Holdback	Channel 1 holdback type	uint8	3e59	15961	Not applicable
Segment.20.Ch1HoldbackVal	Channel 1 holdback value	float32	3e5b	15963	Same as Programmer.Setup.Ch1PVInput
Segment.20.Ch1PVEvent	Channel 1 PV event	uint8	3e64	15972	Not applicable
Segment.20.Ch1PVEventUse	Channel 1 PV event use	bool	3e72	15986	Not applicable
Segment.20.Ch1PVEventVal	Channel 1 PV event value	float32	3e66	15974	Same as Programmer.Setup.Ch1PVInput
Segment.20.Ch1Rate	Channel 1 rate	float32	3e56	15958	Set by Programmer.Setup.RateResolution
Segment.20.Ch1Time	Channel 1 time	time_t	3e54	15956	Set by Network.Modbus.TimeFormat
Segment.20.Ch1TSP	Channel 1 target set-point	float32	3e52	15954	Same as Programmer.Setup.Ch1PVInput
Segment.20.Ch1UserVal	Channel 1 user value	float32	3e68	15976	Same as Programmer.Setup.ResetCh1UserVal
Segment.20.Ch1Wait	Channel 1 Wait	uint8	3e5e	15966	Not applicable
Segment.20.Ch1WaitVal	Channel 1 wait value	float32	3e60	15968	Same as Programmer.Setup.PVWait1
Segment.20.Ch2Holdback	Channel 2 holdback type	uint8	3e5a	15962	Not applicable
Segment.20.Ch2HoldbackVal	Channel 2 holdback value	float32	3e5c	15964	Same as Programmer.Setup.Ch2PVInput
Segment.20.Ch2PVEvent	Channel 2 PV event	uint8	3e65	15973	Not applicable
Segment.20.Ch2PVEventUse	Channel 2 PV event use	bool	3e73	15987	Not applicable
Segment.20.Ch2PVEventVal	Channel 2 PV event value	float32	3e67	15975	Same as Programmer.Setup.Ch2PVInput
Segment.20.Ch2Rate	Channel 2 rate	float32	3e57	15959	Set by Programmer.Setup.RateResolution
Segment.20.Ch2Time	Channel 2 time	time_t	3e55	15957	Set by Network.Modbus.TimeFormat
Segment.20.Ch2TSP	Channel 2 target set-point	float32	3e53	15955	Same as Programmer.Setup.Ch2PVInput
Segment.20.Ch2UserVal	Channel 2 user value	float32	3e69	15977	Same as Programmer.Setup.ResetCh2UserVal
Segment.20.Ch2Wait	Channel 2 Wait	uint8	3e5f	15967	Not applicable
Segment.20.Ch2WaitVal	Channel 2 wait value	float32	3e61	15969	Same as Programmer.Setup.PVWait2
Segment.20.Cycles	Cycles	int16	3e63	15971	Not applicable
Segment.20.Duration	Duration	time_t	3e51	15953	Set by Network.Modbus.TimeFormat
Segment.20.EndType	End type	uint8	3e58	15960	Not applicable
Segment.20.Event1	Event 1	bool	3e6a	15978	Not applicable
Segment.20.Event2	Event 2	bool	3e6b	15979	Not applicable
Segment.20.Event3	Event 3	bool	3e6c	15980	Not applicable
Segment.20.Event4	Event 4	bool	3e6d	15981	Not applicable
Segment.20.Event5	Event 5	bool	3e6e	15982	Not applicable
Segment.20.Event6	Event 6	bool	3e6f	15983	Not applicable
Segment.20.Event7	Event 7	bool	3e70	15984	Not applicable
Segment.20.Event8	Event 8	bool	3e71	15985	Not applicable
Segment.20.GoBackTo	Go back to	uint8	3e62	15970	Not applicable
Segment.20.SegmentName	Segment name	string_t	6c5f	27743	Not applicable
Segment.20.Type	Type	uint8	3e50	15952	Not applicable
Segment.20.WaitFor	Wait for	uint8	3e5d	15965	Not applicable
Segment 21 For parameter values and settings (enumerations) see Segment 1					
Segment.21.Ch1Holdback	Channel 1 holdback type	uint8	3e89	16009	Not applicable
Segment.21.Ch1HoldbackVal	Channel 1 holdback value	float32	3e8b	16011	Same as Programmer.Setup.Ch1PVInput
Segment.21.Ch1PVEvent	Channel 1 PV event	uint8	3e94	16020	Not applicable
Segment.21.Ch1PVEventUse	Channel 1 PV event use	bool	3ea2	16034	Not applicable
Segment.21.Ch1PVEventVal	Channel 1 PV event value	float32	3e96	16022	Same as Programmer.Setup.Ch1PVInput
Segment.21.Ch1Rate	Channel 1 rate	float32	3e86	16006	Set by Programmer.Setup.RateResolution
Segment.21.Ch1Time	Channel 1 time	time_t	3e84	16004	Set by Network.Modbus.TimeFormat
Segment.21.Ch1TSP	Channel 1 target set-point	float32	3e82	16002	Same as Programmer.Setup.Ch1PVInput
Segment.21.Ch1UserVal	Channel 1 user value	float32	3e98	16024	Same as Programmer.Setup.ResetCh1UserVal
Segment.21.Ch1Wait	Channel 1 Wait	uint8	3e8e	16014	Not applicable
Segment.21.Ch1WaitVal	Channel 1 wait value	float32	3e90	16016	Same as Programmer.Setup.PVWait1
Segment.21.Ch2Holdback	Channel 2 holdback type	uint8	3e8a	16010	Not applicable
Segment.21.Ch2HoldbackVal	Channel 2 holdback value	float32	3e8c	16012	Same as Programmer.Setup.Ch2PVInput
Segment.21.Ch2PVEvent	Channel 2 PV event	uint8	3e95	16021	Not applicable
Segment.21.Ch2PVEventUse	Channel 2 PV event use	bool	3ea3	16035	Not applicable
Segment.21.Ch2PVEventVal	Channel 2 PV event value	float32	3e97	16023	Same as Programmer.Setup.Ch2PVInput
Segment.21.Ch2Rate	Channel 2 rate	float32	3e87	16007	Set by Programmer.Setup.RateResolution
Segment.21.Ch2Time	Channel 2 time	time_t	3e85	16005	Set by Network.Modbus.TimeFormat

Parameter path	Description	Type	Hex	Dec	Resolution
Segment.21.Ch2UserVal	Channel 2 user value	float32	3e99	16025	Same as Programmer.Setup.ResetCh2UserVal
Segment.21.Ch2Wait	Channel 2 Wait	uint8	3e8f	16015	Not applicable
Segment.21.Ch2WaitVal	Channel 2 wait value	float32	3e91	16017	Same as Programmer.Setup.PVWait2
Segment.21.Cycles	Cycles	int16	3e93	16019	Not applicable
Segment.21.Duration	Duration	time_t	3e81	16001	Set by Network.Modbus.TimeFormat
Segment.21.EndType	End type	uint8	3e88	16008	Not applicable
Segment.21.Event1	Event 1	bool	3e9a	16026	Not applicable
Segment.21.Event2	Event 2	bool	3e9b	16027	Not applicable
Segment.21.Event3	Event 3	bool	3e9c	16028	Not applicable
Segment.21.Event4	Event 4	bool	3e9d	16029	Not applicable
Segment.21.Event5	Event 5	bool	3e9e	16030	Not applicable
Segment.21.Event6	Event 6	bool	3e9f	16031	Not applicable
Segment.21.Event7	Event 7	bool	3ea0	16032	Not applicable
Segment.21.Event8	Event 8	bool	3ea1	16033	Not applicable
Segment.21.GoBackTo	Go back to	uint8	3e92	16018	Not applicable
Segment.21.SegmentName	Segment name	string_t	6c74	27764	Not applicable
Segment.21.Type	Type	uint8	3e80	16000	Not applicable
Segment.21.WaitFor	Wait for	uint8	3e8d	16013	Not applicable
Segment 22 For parameter values and settings (enumerations) see Segment 1					
Segment.22.Ch1Holdback	Channel 1 holdback type	uint8	3eb9	16057	Not applicable
Segment.22.Ch1HoldbackVal	Channel 1 holdback value	float32	3ebb	16059	Same as Programmer.Setup.Ch1PVInput
Segment.22.Ch1PVEvent	Channel 1 PV event	uint8	3ec4	16068	Not applicable
Segment.22.Ch1PVEventUse	Channel 1 PV event use	bool	3ed2	16082	Not applicable
Segment.22.Ch1PVEventVal	Channel 1 PV event value	float32	3ec6	16070	Same as Programmer.Setup.Ch1PVInput
Segment.22.Ch1Rate	Channel 1 rate	float32	3eb6	16054	Set by Programmer.Setup.RateResolution
Segment.22.Ch1Time	Channel 1 time	time_t	3eb4	16052	Set by Network.Modbus.TimeFormat
Segment.22.Ch1TSP	Channel 1 target set-point	float32	3eb2	16050	Same as Programmer.Setup.Ch1PVInput
Segment.22.Ch1UserVal	Channel 1 user value	float32	3ec8	16072	Same as Programmer.Setup.ResetCh1UserVal
Segment.22.Ch1Wait	Channel 1 Wait	uint8	3ebe	16062	Not applicable
Segment.22.Ch1WaitVal	Channel 1 wait value	float32	3ec0	16064	Same as Programmer.Setup.PVWait1
Segment.22.Ch2Holdback	Channel 2 holdback type	uint8	3eba	16058	Not applicable
Segment.22.Ch2HoldbackVal	Channel 2 holdback value	float32	3ebc	16060	Same as Programmer.Setup.Ch2PVInput
Segment.22.Ch2PVEvent	Channel 2 PV event	uint8	3ec5	16069	Not applicable
Segment.22.Ch2PVEventUse	Channel 2 PV event use	bool	3ed3	16083	Not applicable
Segment.22.Ch2PVEventVal	Channel 2 PV event value	float32	3ec7	16071	Same as Programmer.Setup.Ch2PVInput
Segment.22.Ch2Rate	Channel 2 rate	float32	3eb7	16055	Set by Programmer.Setup.RateResolution
Segment.22.Ch2Time	Channel 2 time	time_t	3eb5	16053	Set by Network.Modbus.TimeFormat
Segment.22.Ch2TSP	Channel 2 target set-point	float32	3eb3	16051	Same as Programmer.Setup.Ch2PVInput
Segment.22.Ch2UserVal	Channel 2 user value	float32	3ec9	16073	Same as Programmer.Setup.ResetCh2UserVal
Segment.22.Ch2Wait	Channel 2 Wait	uint8	3ebf	16063	Not applicable
Segment.22.Ch2WaitVal	Channel 2 wait value	float32	3ec1	16065	Same as Programmer.Setup.PVWait2
Segment.22.Cycles	Cycles	int16	3ec3	16067	Not applicable
Segment.22.Duration	Duration	time_t	3eb1	16049	Set by Network.Modbus.TimeFormat
Segment.22.EndType	End type	uint8	3eb8	16056	Not applicable
Segment.22.Event1	Event 1	bool	3eca	16074	Not applicable
Segment.22.Event2	Event 2	bool	3ecb	16075	Not applicable
Segment.22.Event3	Event 3	bool	3ecc	16076	Not applicable
Segment.22.Event4	Event 4	bool	3ecd	16077	Not applicable
Segment.22.Event5	Event 5	bool	3ece	16078	Not applicable
Segment.22.Event6	Event 6	bool	3ecf	16079	Not applicable
Segment.22.Event7	Event 7	bool	3ed0	16080	Not applicable
Segment.22.Event8	Event 8	bool	3ed1	16081	Not applicable
Segment.22.GoBackTo	Go back to	uint8	3ec2	16066	Not applicable
Segment.22.SegmentName	Segment name	string_t	6c89	27785	Not applicable
Segment.22.Type	Type	uint8	3eb0	16048	Not applicable
Segment.22.WaitFor	Wait for	uint8	3ebd	16061	Not applicable
Segment 23 For parameter values and settings (enumerations) see Segment 1					

Parameter path	Description	Type	Hex	Dec	Resolution
Segment.23.Ch1HoldbackVal	Channel 1 holdback value	float32	3eeb	16107	Same as Programmer.Setup.Ch1PVInput
Segment.23.Ch1PVEvent	Channel 1 PV event	uint8	3ef4	16116	Not applicable
Segment.23.Ch1PVEventUse	Channel 1 PV event use	bool	3f02	16130	Not applicable
Segment.23.Ch1PVEventVal	Channel 1 PV event value	float32	3ef6	16118	Same as Programmer.Setup.Ch1PVInput
Segment.23.Ch1Rate	Channel 1 rate	float32	3ee6	16102	Set by Programmer.Setup.RateResolution
Segment.23.Ch1Time	Channel 1 time	time_t	3ee4	16100	Set by Network.Modbus.TimeFormat
Segment.23.Ch1TSP	Channel 1 target set-point	float32	3ee2	16098	Same as Programmer.Setup.Ch1PVInput
Segment.23.Ch1UserVal	Channel 1 user value	float32	3ef8	16120	Same as Programmer.Setup.ResetCh1UserVal
Segment.23.Ch1Wait	Channel 1 Wait	uint8	3eee	16110	Not applicable
Segment.23.Ch1WaitVal	Channel 1 wait value	float32	3ef0	16112	Same as Programmer.Setup.PVWait1
Segment.23.Ch2Holdback	Channel 2 holdback type	uint8	3eea	16106	Not applicable
Segment.23.Ch2HoldbackVal	Channel 2 holdback value	float32	3eec	16108	Same as Programmer.Setup.Ch2PVInput
Segment.23.Ch2PVEvent	Channel 2 PV event	uint8	3ef5	16117	Not applicable
Segment.23.Ch2PVEventUse	Channel 2 PV event use	bool	3f03	16131	Not applicable
Segment.23.Ch2PVEventVal	Channel 2 PV event value	float32	3ef7	16119	Same as Programmer.Setup.Ch2PVInput
Segment.23.Ch2Rate	Channel 2 rate	float32	3ee7	16103	Set by Programmer.Setup.RateResolution
Segment.23.Ch2Time	Channel 2 time	time_t	3ee5	16101	Set by Network.Modbus.TimeFormat
Segment.23.Ch2TSP	Channel 2 target set-point	float32	3ee3	16099	Same as Programmer.Setup.Ch2PVInput
Segment.23.Ch2UserVal	Channel 2 user value	float32	3ef9	16121	Same as Programmer.Setup.ResetCh2UserVal
Segment.23.Ch2Wait	Channel 2 Wait	uint8	3eef	16111	Not applicable
Segment.23.Ch2WaitVal	Channel 2 wait value	float32	3ef1	16113	Same as Programmer.Setup.PVWait2
Segment.23.Cycles	Cycles	int16	3ef3	16115	Not applicable
Segment.23.Duration	Duration	time_t	3ee1	16097	Set by Network.Modbus.TimeFormat
Segment.23.EndType	End type	uint8	3ee8	16104	Not applicable
Segment.23.Event1	Event 1	bool	3efa	16122	Not applicable
Segment.23.Event2	Event 2	bool	3efb	16123	Not applicable
Segment.23.Event3	Event 3	bool	3efc	16124	Not applicable
Segment.23.Event4	Event 4	bool	3efd	16125	Not applicable
Segment.23.Event5	Event 5	bool	3efe	16126	Not applicable
Segment.23.Event6	Event 6	bool	3eff	16127	Not applicable
Segment.23.Event7	Event 7	bool	3f00	16128	Not applicable
Segment.23.Event8	Event 8	bool	3f01	16129	Not applicable
Segment.23.GoBackTo	Go back to	uint8	3ef2	16114	Not applicable
Segment.23.SegmentName	Segment name	string_t	6c9e	27806	Not applicable
Segment.23.Type	Type	uint8	3ee0	16096	Not applicable
Segment.23.WaitFor	Wait for	uint8	3eed	16109	Not applicable
Segment 24 For parameter values and settings (enumerations) see Segment 1					
Segment.24.Ch1Holdback	Channel 1 holdback type	uint8	3f19	16153	Not applicable
Segment.24.Ch1HoldbackVal	Channel 1 holdback value	float32	3f1b	16155	Same as Programmer.Setup.Ch1PVInput
Segment.24.Ch1PVEvent	Channel 1 PV event	uint8	3f24	16164	Not applicable
Segment.24.Ch1PVEventUse	Channel 1 PV event use	bool	3f32	16178	Not applicable
Segment.24.Ch1PVEventVal	Channel 1 PV event value	float32	3f26	16166	Same as Programmer.Setup.Ch1PVInput
Segment.24.Ch1Rate	Channel 1 rate	float32	3f16	16150	Set by Programmer.Setup.RateResolution
Segment.24.Ch1Time	Channel 1 time	time_t	3f14	16148	Set by Network.Modbus.TimeFormat
Segment.24.Ch1TSP	Channel 1 target set-point	float32	3f12	16146	Same as Programmer.Setup.Ch1PVInput
Segment.24.Ch1UserVal	Channel 1 user value	float32	3f28	16168	Same as Programmer.Setup.ResetCh1UserVal
Segment.24.Ch1Wait	Channel 1 Wait	uint8	3f1e	16158	Not applicable
Segment.24.Ch1WaitVal	Channel 1 wait value	float32	3f20	16160	Same as Programmer.Setup.PVWait1
Segment.24.Ch2Holdback	Channel 2 holdback type	uint8	3f1a	16154	Not applicable
Segment.24.Ch2HoldbackVal	Channel 2 holdback value	float32	3f1c	16156	Same as Programmer.Setup.Ch2PVInput
Segment.24.Ch2PVEvent	Channel 2 PV event	uint8	3f25	16165	Not applicable
Segment.24.Ch2PVEventUse	Channel 2 PV event use	bool	3f33	16179	Not applicable
Segment.24.Ch2PVEventVal	Channel 2 PV event value	float32	3f27	16167	Same as Programmer.Setup.Ch2PVInput
Segment.24.Ch2Rate	Channel 2 rate	float32	3f17	16151	Set by Programmer.Setup.RateResolution
Segment.24.Ch2Time	Channel 2 time	time_t	3f15	16149	Set by Network.Modbus.TimeFormat
Segment.24.Ch2TSP	Channel 2 target set-point	float32	3f13	16147	Same as Programmer.Setup.Ch2PVInput
Segment.24.Ch2UserVal	Channel 2 user value	float32	3f29	16169	Same as Programmer.Setup.ResetCh2UserVal
Segment.24.Ch2Wait	Channel 2 Wait	uint8	3f1f	16159	Not applicable

Parameter path	Description	Type	Hex	Dec	Resolution
Segment.24.Cycles	Cycles	int16	3f23	16163	Not applicable
Segment.24.Duration	Duration	time_t	3f11	16145	Set by Network.Modbus.TimeFormat
Segment.24.EndType	End type	uint8	3f18	16152	Not applicable
Segment.24.Event1	Event 1	bool	3f2a	16170	Not applicable
Segment.24.Event2	Event 2	bool	3f2b	16171	Not applicable
Segment.24.Event3	Event 3	bool	3f2c	16172	Not applicable
Segment.24.Event4	Event 4	bool	3f2d	16173	Not applicable
Segment.24.Event5	Event 5	bool	3f2e	16174	Not applicable
Segment.24.Event6	Event 6	bool	3f2f	16175	Not applicable
Segment.24.Event7	Event 7	bool	3f30	16176	Not applicable
Segment.24.Event8	Event 8	bool	3f31	16177	Not applicable
Segment.24.GoBackTo	Go back to	uint8	3f22	16162	Not applicable
Segment.24.SegmentName	Segment name	string_t	6cb3	27827	Not applicable
Segment.24.Type	Type	uint8	3f10	16144	Not applicable
Segment.24.WaitFor	Wait for	uint8	3f1d	16157	Not applicable
Segment 25 For parameter values and settings (enumerations) see Segment 1					
Segment.25.Ch1Holdback	Channel 1 holdback type	uint8	3f49	16201	Not applicable
Segment.25.Ch1HoldbackVal	Channel 1 holdback value	float32	3f4b	16203	Same as Programmer.Setup.Ch1PVInput
Segment.25.Ch1PVEvent	Channel 1 PV event	uint8	3f54	16212	Not applicable
Segment.25.Ch1PVEventUse	Channel 1 PV event use	bool	3f62	16226	Not applicable
Segment.25.Ch1PVEventVal	Channel 1 PV event value	float32	3f56	16214	Same as Programmer.Setup.Ch1PVInput
Segment.25.Ch1Rate	Channel 1 rate	float32	3f46	16198	Set by Programmer.Setup.RateResolution
Segment.25.Ch1Time	Channel 1 time	time_t	3f44	16196	Set by Network.Modbus.TimeFormat
Segment.25.Ch1TSP	Channel 1 target set-point	float32	3f42	16194	Same as Programmer.Setup.Ch1PVInput
Segment.25.Ch1UserVal	Channel 1 user value	float32	3f58	16216	Same as Programmer.Setup.ResetCh1UserVal
Segment.25.Ch1Wait	Channel 1 Wait	uint8	3f4e	16206	Not applicable
Segment.25.Ch1WaitVal	Channel 1 wait value	float32	3f50	16208	Same as Programmer.Setup.PVWait1
Segment.25.Ch2Holdback	Channel 2 holdback type	uint8	3f4a	16202	Not applicable
Segment.25.Ch2HoldbackVal	Channel 2 holdback value	float32	3f4c	16204	Same as Programmer.Setup.Ch2PVInput
Segment.25.Ch2PVEvent	Channel 2 PV event	uint8	3f55	16213	Not applicable
Segment.25.Ch2PVEventUse	Channel 2 PV event use	bool	3f63	16227	Not applicable
Segment.25.Ch2PVEventVal	Channel 2 PV event value	float32	3f57	16215	Same as Programmer.Setup.Ch2PVInput
Segment.25.Ch2Rate	Channel 2 rate	float32	3f47	16199	Set by Programmer.Setup.RateResolution
Segment.25.Ch2Time	Channel 2 time	time_t	3f45	16197	Set by Network.Modbus.TimeFormat
Segment.25.Ch2TSP	Channel 2 target set-point	float32	3f43	16195	Same as Programmer.Setup.Ch2PVInput
Segment.25.Ch2UserVal	Channel 2 user value	float32	3f59	16217	Same as Programmer.Setup.ResetCh2UserVal
Segment.25.Ch2Wait	Channel 2 Wait	uint8	3f4f	16207	Not applicable
Segment.25.Ch2WaitVal	Channel 2 wait value	float32	3f51	16209	Same as Programmer.Setup.PVWait2
Segment.25.Cycles	Cycles	int16	3f53	16211	Not applicable
Segment.25.Duration	Duration	time_t	3f41	16193	Set by Network.Modbus.TimeFormat
Segment.25.EndType	End type	uint8	3f48	16200	Not applicable
Segment.25.Event1	Event 1	bool	3f5a	16218	Not applicable
Segment.25.Event2	Event 2	bool	3f5b	16219	Not applicable
Segment.25.Event3	Event 3	bool	3f5c	16220	Not applicable
Segment.25.Event4	Event 4	bool	3f5d	16221	Not applicable
Segment.25.Event5	Event 5	bool	3f5e	16222	Not applicable
Segment.25.Event6	Event 6	bool	3f5f	16223	Not applicable
Segment.25.Event7	Event 7	bool	3f60	16224	Not applicable
Segment.25.Event8	Event 8	bool	3f61	16225	Not applicable
Segment.25.GoBackTo	Go back to	uint8	3f52	16210	Not applicable
Segment.25.SegmentName	Segment name	string_t	6cc8	27848	Not applicable
Segment.25.Type	Type	uint8	3f40	16192	Not applicable
Segment.25.WaitFor	Wait for	uint8	3f4d	16205	Not applicable
Segment 26 For parameter values and settings (enumerations) see Segment 1					
Segment.26.Ch1Holdback	Channel 1 holdback type	uint8	3f79	16249	Not applicable
Segment.26.Ch1HoldbackVal	Channel 1 holdback value	float32	3f7b	16251	Same as Programmer.Setup.Ch1PVInput
Segment.26.Ch1PVEvent	Channel 1 PV event	uint8	3f84	16260	Not applicable
Segment.26.Ch1PVEventUse	Channel 1 PV event use	bool	3f92	16274	Not applicable

Parameter path	Description	Type	Hex	Dec	Resolution
Segment.26.Ch1Rate	Channel 1 rate	float32	3f76	16246	Set by Programmer.Setup.RateResolution
Segment.26.Ch1Time	Channel 1 time	time_t	3f74	16244	Set by Network.Modbus.TimeFormat
Segment.26.Ch1TSP	Channel 1 target set-point	float32	3f72	16242	Same as Programmer.Setup.Ch1PVInput
Segment.26.Ch1UserVal	Channel 1 user value	float32	3f88	16264	Same as Programmer.Setup.ResetCh1UserVal
Segment.26.Ch1Wait	Channel 1 Wait	uint8	3f7e	16254	Not applicable
Segment.26.Ch1WaitVal	Channel 1 wait value	float32	3f80	16256	Same as Programmer.Setup.PVWait1
Segment.26.Ch2Holdback	Channel 2 holdback type	uint8	3f7a	16250	Not applicable
Segment.26.Ch2HoldbackVal	Channel 2 holdback value	float32	3f7c	16252	Same as Programmer.Setup.Ch2PVInput
Segment.26.Ch2PVEvent	Channel 2 PV event	uint8	3f85	16261	Not applicable
Segment.26.Ch2PVEventUse	Channel 2 PV event use	bool	3f93	16275	Not applicable
Segment.26.Ch2PVEventVal	Channel 2 PV event value	float32	3f87	16263	Same as Programmer.Setup.Ch2PVInput
Segment.26.Ch2Rate	Channel 2 rate	float32	3f77	16247	Set by Programmer.Setup.RateResolution
Segment.26.Ch2Time	Channel 2 time	time_t	3f75	16245	Set by Network.Modbus.TimeFormat
Segment.26.Ch2TSP	Channel 2 target set-point	float32	3f73	16243	Same as Programmer.Setup.Ch2PVInput
Segment.26.Ch2UserVal	Channel 2 user value	float32	3f89	16265	Same as Programmer.Setup.ResetCh2UserVal
Segment.26.Ch2Wait	Channel 2 Wait	uint8	3f7f	16255	Not applicable
Segment.26.Ch2WaitVal	Channel 2 wait value	float32	3f81	16257	Same as Programmer.Setup.PVWait2
Segment.26.Cycles	Cycles	int16	3f83	16259	Not applicable
Segment.26.Duration	Duration	time_t	3f71	16241	Set by Network.Modbus.TimeFormat
Segment.26.EndType	End type	uint8	3f78	16248	Not applicable
Segment.26.Event1	Event 1	bool	3f8a	16266	Not applicable
Segment.26.Event2	Event 2	bool	3f8b	16267	Not applicable
Segment.26.Event3	Event 3	bool	3f8c	16268	Not applicable
Segment.26.Event4	Event 4	bool	3f8d	16269	Not applicable
Segment.26.Event5	Event 5	bool	3f8e	16270	Not applicable
Segment.26.Event6	Event 6	bool	3f8f	16271	Not applicable
Segment.26.Event7	Event 7	bool	3f90	16272	Not applicable
Segment.26.Event8	Event 8	bool	3f91	16273	Not applicable
Segment.26.GoBackTo	Go back to	uint8	3f82	16258	Not applicable
Segment.26.SegmentName	Segment name	string_t	6cdd	27869	Not applicable
Segment.26.Type	Type	uint8	3f70	16240	Not applicable
Segment.26.WaitFor	Wait for	uint8	3f7d	16253	Not applicable
Steriliser.AutoCounter	Automatically increments the cycle number	bool	2e0f	11791	Not applicable
Steriliser.CycleNumber	Current cycle number	int32	2e04	11780	Not applicable
Steriliser.CycleStatus	The current cycle status. 0 = Waiting start 1 = Waiting 2 = Equilibration 3 = Sterilising 4 = Passed 5 = Failed 6 = Aborted 7 = Test cycle	uint8	2e08	11784	Not applicable
Steriliser.CycleTime	The total cycle time	time_t	2e25	11813	Set by Network.Modbus.TimeFormat
Steriliser.EquilibrationTime	The equilibration time period for the current cycle.	time_t	2e0c	11788	Set by Network.Modbus.TimeFormat
Steriliser.FailureDwell1	Failure alarm dwell time for input 1	time_t	2e22	11810	Set by Network.Modbus.TimeFormat
Steriliser.FailureDwell2	Failure alarm dwell time for input 2	time_t	2e2b	11819	Set by Network.Modbus.TimeFormat
Steriliser.FailureDwell3	Failure alarm dwell time for input 3	time_t	2e2c	11820	Set by Network.Modbus.TimeFormat
Steriliser.FailureDwell4	Failure alarm dwell time for input 4	time_t	2e2d	11821	Set by Network.Modbus.TimeFormat
Steriliser.FileByTag	Name historical files by cycle number and tag 0 = File by Tag Off; 1 = File by Tag On	bool	2e21	11809	Not applicable
Steriliser.FileTag	Used as part of the historical filename	string_t	68f7	26871	Not applicable
Steriliser.Fvalue	F0 (A0)	time_t	2e26	11814	Set by Network.Modbus.TimeFormat
Steriliser.Input1PV	Input 1	float32	2e00	11776	0dp
Steriliser.Input2PV	Input 2	float32	2e01	11777	0dp
Steriliser.Input3PV	Input 3	float32	2e02	11778	0dp
Steriliser.Input4PV	Input 4	float32	2e03	11779	0dp
Steriliser.InputType1	Input type 1 0 = Off 1 = thermocouple 2 = Rising pressure 3 = Falling pressure 4 = Rise air detect 5 = Fall air detect	uint8	2e1d	11805	Not applicable
Steriliser.InputType2	Input type 2 (as Input type 1, above)	uint8	2e1e	11806	Not applicable
Steriliser.InputType3	Input type 3 (as Input type 1, above)	uint8	2e1f	11807	Not applicable
Steriliser.InputType4	Input type 4 (as Input type 1, above)	uint8	2e20	11808	Not applicable
Steriliser.IP1BandHigh	Sterilisation temperature input 1 band high.	float32	2e0a	11786	Same as Steriliser.Input1PV

Parameter path	Description	Type	Hex	Dec	Resolution
Steriliser.IP1TargetSP	Input 1 target setpoint	float32	2e07	11783	Same as Steriliser.Input1PV
Steriliser.IP2BandHigh	Sterilisation temperature input 2 band high.	float32	2e10	11792	Same as Steriliser.Input2PV
Steriliser.IP2BandLow	Sterilisation temperature input 2 band low.	float32	2e11	11793	Same as Steriliser.Input2PV
Steriliser.IP2TargetSP	Input 2 target setpoint	float32	2e16	11798	Same as Steriliser.Input2PV
Steriliser.IP3BandHigh	Sterilisation temperature input 3 band high.	float32	2e12	11794	Same as Steriliser.Input3PV
Steriliser.IP3BandLow	Sterilisation temperature input 3 band low.	float32	2e13	11795	Same as Steriliser.Input3PV
Steriliser.IP3TargetSP	Input 3 target setpoint	float32	2e17	11799	Same as Steriliser.Input3PV
Steriliser.IP4BandHigh	Sterilisation temperature input 4 band high.	float32	2e14	11796	Same as Steriliser.Input4PV
Steriliser.IP4BandLow	Sterilisation temperature input 4 band low.	float32	2e15	11797	Same as Steriliser.Input3PV
Steriliser.IP4TargetSP	Input 4 target setpoint	float32	2e18	11800	Same as Steriliser.Input4PV
Steriliser.LowLimit	Low temperature limit for the F0 calculation.	float32	2e2a	11818	0dp
Steriliser.MeasuredTemp	Measured Temperature used in the F0 calculation.	float32	2e27	11815	0dp
Steriliser.PassedOutput	1 = cycle passed; 0 = cycle failed.	uint8	2e1c	11804	Not applicable
Steriliser.Remaining	The holding time remaining for the current cycle.	time_t	2e0e	11790	Set by Network.Modbus.TimeFormat
Steriliser.RunningOutput	1 = cycle running; 0 = cycle not running	uint8	2e1b	11803	Not applicable
Steriliser.Start121	Start a predefined 121°C cycle	bool	2e19	11801	Not applicable
Steriliser.Start134	Start a predefined 134°C cycle	bool	2e1a	11802	Not applicable
Steriliser.StartCycle	Start a custom cycle	bool	2e05	11781	Not applicable
Steriliser.SterilisingTime	The total time the load was at sterilisation conditions.	time_t	2e0d	11789	Set by Network.Modbus.TimeFormat
Steriliser.TargetTemperature	Target Temperature for the F0 calculation.	float32	2e29	11817	0dp
Steriliser.TargetTime	The target time of the sterilisation period.	time_t	2e09	11785	Set by Network.Modbus.TimeFormat
Steriliser.TargetTime121	The target time for a 121°C cycle	time_t	2e23	11811	Set by Network.Modbus.TimeFormat
Steriliser.TargetTime134	The target time for a 134°C cycle	time_t	2e24	11812	Set by Network.Modbus.TimeFormat
Steriliser.ZTemperatureInterval	The Z temperature interval for the F0 calculation.	float32	2e28	11816	0dp
Timer.1.ElapsedTime	Elapsed Time	time_t	2ee0	12000	Set by Network.Modbus.TimeFormat
Timer.1.In	Trigger/Gate input	bool	2ee5	12005	Not applicable
Timer.1.Out	Output (1 = On; 0 = Off)	bool	2ee1	12001	Not applicable
Timer.1.Time	Period for the timer (hh:mm:ss)	time_t	2ee2	12002	Set by Network.Modbus.TimeFormat
Timer.1.Triggered	1 = Timer triggered; 0 = Timer not triggered	bool	2ee3	12003	Not applicable
Timer.1.Type	Type of Timer 0 = Disabled (off) 1 = On Pulse 2 = On delay 3 = One shot 4 = Min on.	uint8	2ee4	12004	Not applicable
Timer.2.ElapsedTime	Elapsed Time	time_t	2ee6	12006	Set by Network.Modbus.TimeFormat
Timer.2.In	Trigger/Gate input	bool	2eeb	12011	Not applicable
Timer.2.Out	Output (1 = On; 0 = Off)	bool	2ee7	12007	Not applicable
Timer.2.Time	Period for the timer (hh:mm:ss)	time_t	2ee8	12008	Set by Network.Modbus.TimeFormat
Timer.2.Triggered	1 = Timer triggered; 0 = Timer not triggered	bool	2ee9	12009	Not applicable
Timer.2.Type	Type of Timer (as Timer.1.Type)	uint8	2eea	12010	Not applicable
Timer.3.ElapsedTime	Elapsed Time	time_t	2eec	12012	Set by Network.Modbus.TimeFormat
Timer.3.In	Trigger/Gate input	bool	2ef1	12017	Not applicable
Timer.3.Out	Output (1 = On; 0 = Off)	bool	2eed	12013	Not applicable
Timer.3.Time	Period for the timer (hh:mm:ss)	time_t	2eee	12014	Set by Network.Modbus.TimeFormat
Timer.3.Triggered	1 = Timer triggered; 0 = Timer not triggered	bool	2eef	12015	Not applicable
Timer.3.Type	Type of Timer (as Timer.1.Type)	uint8	2ef0	12016	Not applicable
Timer.4.ElapsedTime	Elapsed Time	time_t	2ef2	12018	Set by Network.Modbus.TimeFormat
Timer.4.In	Trigger/Gate input	bool	2ef7	12023	Not applicable
Timer.4.Out	Output (1 = On; 0 = Off)	bool	2ef3	12019	Not applicable
Timer.4.Time	Period for the timer (hh:mm:ss)	time_t	2ef4	12020	Set by Network.Modbus.TimeFormat
Timer.4.Triggered	1 = Timer triggered; 0 = Timer not triggered	bool	2ef5	12021	Not applicable
Timer.4.Type	Type of Timer (as Timer.1.Type)	uint8	2ef6	12022	Not applicable
UserLin.1.NumberOfBreakpoints	Number of points in user linearisation table 1	uint8	2900	10496	Not applicable
UserLin.1.X1	User linearisation table 1 'X' value 1	float32	2901	10497	2dp
UserLin.1.X2	User linearisation table 1 'X' value 2	float32	2903	10499	2dp
UserLin.1.X3	User linearisation table 1 'X' value 3	float32	2905	10501	2dp
UserLin.1.X4	User linearisation table 1 'X' value 4	float32	2907	10503	2dp
UserLin.1.X5	User linearisation table 1 'X' value 5	float32	2909	10505	2dp

Parameter path	Description	Type	Hex	Dec	Resolution
UserLin.1.X7	User linearisation table 1 'X' value 7	float32	290d	10509	2dp
UserLin.1.X8	User linearisation table 1 'X' value 8	float32	290f	10511	2dp
UserLin.1.X9	User linearisation table 1 'X' value 9	float32	2911	10513	2dp
UserLin.1.X10	User linearisation table 1 'X' value 10	float32	2913	10515	2dp
UserLin.1.X11	User linearisation table 1 'X' value 11	float32	2915	10517	2dp
UserLin.1.X12	User linearisation table 1 'X' value 12	float32	2917	10519	2dp
UserLin.1.X13	User linearisation table 1 'X' value 13	float32	2919	10521	2dp
UserLin.1.X14	User linearisation table 1 'X' value 14	float32	291b	10523	2dp
UserLin.1.X15	User linearisation table 1 'X' value 15	float32	291d	10525	2dp
UserLin.1.X16	User linearisation table 1 'X' value 16	float32	291f	10527	2dp
UserLin.1.X17	User linearisation table 1 'X' value 17	float32	2921	10529	2dp
UserLin.1.X18	User linearisation table 1 'X' value 18	float32	2923	10531	2dp
UserLin.1.X19	User linearisation table 1 'X' value 19	float32	2925	10533	2dp
UserLin.1.X20	User linearisation table 1 'X' value 20	float32	2927	10535	2dp
UserLin.1.X21	User linearisation table 1 'X' value 21	float32	2929	10537	2dp
UserLin.1.X22	User linearisation table 1 'X' value 22	float32	292b	10539	2dp
UserLin.1.X23	User linearisation table 1 'X' value 23	float32	292d	10541	2dp
UserLin.1.X24	User linearisation table 1 'X' value 24	float32	292f	10543	2dp
UserLin.1.X25	User linearisation table 1 'X' value 25	float32	2931	10545	2dp
UserLin.1.X26	User linearisation table 1 'X' value 26	float32	2933	10547	2dp
UserLin.1.X27	User linearisation table 1 'X' value 27	float32	2935	10549	2dp
UserLin.1.X28	User linearisation table 1 'X' value 28	float32	2937	10551	2dp
UserLin.1.X29	User linearisation table 1 'X' value 29	float32	2939	10553	2dp
UserLin.1.X30	User linearisation table 1 'X' value 30	float32	293b	10555	2dp
UserLin.1.X31	User linearisation table 1 'X' value 31	float32	293d	10557	2dp
UserLin.1.X32	User linearisation table 1 'X' value 32	float32	293f	10559	2dp
UserLin.1.Y1	User linearisation table 1 'Y' value 1	float32	2902	10498	2dp
UserLin.1.Y2	User linearisation table 1 'Y' value 2	float32	2904	10500	2dp
UserLin.1.Y3	User linearisation table 1 'Y' value 3	float32	2906	10502	2dp
UserLin.1.Y4	User linearisation table 1 'Y' value 4	float32	2908	10504	2dp
UserLin.1.Y5	User linearisation table 1 'Y' value 5	float32	290a	10506	2dp
UserLin.1.Y6	User linearisation table 1 'Y' value 6	float32	290c	10508	2dp
UserLin.1.Y7	User linearisation table 1 'Y' value 7	float32	290e	10510	2dp
UserLin.1.Y8	User linearisation table 1 'Y' value 8	float32	2910	10512	2dp
UserLin.1.Y9	User linearisation table 1 'Y' value 9	float32	2912	10514	2dp
UserLin.1.Y10	User linearisation table 1 'Y' value 10	float32	2914	10516	2dp
UserLin.1.Y11	User linearisation table 1 'Y' value 11	float32	2916	10518	2dp
UserLin.1.Y12	User linearisation table 1 'Y' value 12	float32	2918	10520	2dp
UserLin.1.Y13	User linearisation table 1 'Y' value 13	float32	291a	10522	2dp
UserLin.1.Y14	User linearisation table 1 'Y' value 14	float32	291c	10524	2dp
UserLin.1.Y15	User linearisation table 1 'Y' value 15	float32	291e	10526	2dp
UserLin.1.Y16	User linearisation table 1 'Y' value 16	float32	2920	10528	2dp
UserLin.1.Y17	User linearisation table 1 'Y' value 17	float32	2922	10530	2dp
UserLin.1.Y18	User linearisation table 1 'Y' value 18	float32	2924	10532	2dp
UserLin.1.Y19	User linearisation table 1 'Y' value 19	float32	2926	10534	2dp
UserLin.1.Y20	User linearisation table 1 'Y' value 20	float32	2928	10536	2dp
UserLin.1.Y21	User linearisation table 1 'Y' value 21	float32	292a	10538	2dp
UserLin.1.Y22	User linearisation table 1 'Y' value 22	float32	292c	10540	2dp
UserLin.1.Y23	User linearisation table 1 'Y' value 23	float32	292e	10542	2dp
UserLin.1.Y24	User linearisation table 1 'Y' value 24	float32	2930	10544	2dp
UserLin.1.Y25	User linearisation table 1 'Y' value 25	float32	2932	10546	2dp
UserLin.1.Y26	User linearisation table 1 'Y' value 26	float32	2934	10548	2dp
UserLin.1.Y27	User linearisation table 1 'Y' value 27	float32	2936	10550	2dp
UserLin.1.Y28	User linearisation table 1 'Y' value 28	float32	2938	10552	2dp
UserLin.1.Y29	User linearisation table 1 'Y' value 29	float32	293a	10554	2dp
UserLin.1.Y30	User linearisation table 1 'Y' value 30	float32	293c	10556	2dp
UserLin.1.Y31	User linearisation table 1 'Y' value 31	float32	293e	10558	2dp
UserLin.1.Y32	User linearisation table 1 'Y' value 32	float32	2940	10560	2dp
UserLin.2.NumberOfBreakpoints	Number of points in user linearisation table 2	uint8	29c0	10688	Not applicable

Parameter path	Description	Type	Hex	Dec	Resolution
UserLin.2.X3	User linearisation table 2 'X' value 3	float32	29c5	10693	2dp
UserLin.2.X4	User linearisation table 2 'X' value 4	float32	29c7	10695	2dp
UserLin.2.X5	User linearisation table 2 'X' value 5	float32	29c9	10697	2dp
UserLin.2.X6	User linearisation table 2 'X' value 6	float32	29cb	10699	2dp
UserLin.2.X7	User linearisation table 2 'X' value 7	float32	29cd	10701	2dp
UserLin.2.X8	User linearisation table 2 'X' value 8	float32	29cf	10703	2dp
UserLin.2.X9	User linearisation table 2 'X' value 9	float32	29d1	10705	2dp
UserLin.2.X10	User linearisation table 2 'X' value 10	float32	29d3	10707	2dp
UserLin.2.X11	User linearisation table 2 'X' value 11	float32	29d5	10709	2dp
UserLin.2.X12	User linearisation table 2 'X' value 12	float32	29d7	10711	2dp
UserLin.2.X13	User linearisation table 2 'X' value 13	float32	29d9	10713	2dp
UserLin.2.X14	User linearisation table 2 'X' value 14	float32	29db	10715	2dp
UserLin.2.X15	User linearisation table 2 'X' value 15	float32	29dd	10717	2dp
UserLin.2.X16	User linearisation table 2 'X' value 16	float32	29df	10719	2dp
UserLin.2.X17	User linearisation table 2 'X' value 17	float32	29e1	10721	2dp
UserLin.2.X18	User linearisation table 2 'X' value 18	float32	29e3	10723	2dp
UserLin.2.X19	User linearisation table 2 'X' value 19	float32	29e5	10725	2dp
UserLin.2.X20	User linearisation table 2 'X' value 20	float32	29e7	10727	2dp
UserLin.2.X21	User linearisation table 2 'X' value 21	float32	29e9	10729	2dp
UserLin.2.X22	User linearisation table 2 'X' value 22	float32	29eb	10731	2dp
UserLin.2.X23	User linearisation table 2 'X' value 23	float32	29ed	10733	2dp
UserLin.2.X24	User linearisation table 2 'X' value 24	float32	29ef	10735	2dp
UserLin.2.X25	User linearisation table 2 'X' value 25	float32	29f1	10737	2dp
UserLin.2.X26	User linearisation table 2 'X' value 26	float32	29f3	10739	2dp
UserLin.2.X27	User linearisation table 2 'X' value 27	float32	29f5	10741	2dp
UserLin.2.X28	User linearisation table 2 'X' value 28	float32	29f7	10743	2dp
UserLin.2.X29	User linearisation table 2 'X' value 29	float32	29f9	10745	2dp
UserLin.2.X30	User linearisation table 2 'X' value 30	float32	29fb	10747	2dp
UserLin.2.X31	User linearisation table 2 'X' value 31	float32	29fd	10749	2dp
UserLin.2.X32	User linearisation table 2 'X' value 32	float32	29ff	10751	2dp
UserLin.2.Y1	User linearisation table 2 'Y' value 1	float32	29c2	10690	2dp
UserLin.2.Y2	User linearisation table 4 'Y' value 2	float32	29c4	10692	2dp
UserLin.2.Y3	User linearisation table 4 'Y' value 3	float32	29c6	10694	2dp
UserLin.2.Y4	User linearisation table 4 'Y' value 4	float32	29c8	10696	2dp
UserLin.2.Y5	User linearisation table 4 'Y' value 5	float32	29ca	10698	2dp
UserLin.2.Y6	User linearisation table 4 'Y' value 6	float32	29cc	10700	2dp
UserLin.2.Y7	User linearisation table 4 'Y' value 7	float32	29ce	10702	2dp
UserLin.2.Y8	User linearisation table 4 'Y' value 8	float32	29d0	10704	2dp
UserLin.2.Y9	User linearisation table 4 'Y' value 9	float32	29d2	10706	2dp
UserLin.2.Y10	User linearisation table 4 'Y' value 10	float32	29d4	10708	2dp
UserLin.2.Y11	User linearisation table 4 'Y' value 11	float32	29d6	10710	2dp
UserLin.2.Y12	User linearisation table 4 'Y' value 12	float32	29d8	10712	2dp
UserLin.2.Y13	User linearisation table 4 'Y' value 13	float32	29da	10714	2dp
UserLin.2.Y14	User linearisation table 4 'Y' value 14	float32	29dc	10716	2dp
UserLin.2.Y15	User linearisation table 4 'Y' value 15	float32	29de	10718	2dp
UserLin.2.Y16	User linearisation table 4 'Y' value 16	float32	29e0	10720	2dp
UserLin.2.Y17	User linearisation table 4 'Y' value 17	float32	29e2	10722	2dp
UserLin.2.Y18	User linearisation table 4 'Y' value 18	float32	29e4	10724	2dp
UserLin.2.Y19	User linearisation table 4 'Y' value 19	float32	29e6	10726	2dp
UserLin.2.Y20	User linearisation table 4 'Y' value 20	float32	29e8	10728	2dp
UserLin.2.Y21	User linearisation table 4 'Y' value 21	float32	29ea	10730	2dp
UserLin.2.Y22	User linearisation table 4 'Y' value 22	float32	29ec	10732	2dp
UserLin.2.Y23	User linearisation table 4 'Y' value 23	float32	29ee	10734	2dp
UserLin.2.Y24	User linearisation table 4 'Y' value 24	float32	29f0	10736	2dp
UserLin.2.Y25	User linearisation table 4 'Y' value 25	float32	29f2	10738	2dp
UserLin.2.Y26	User linearisation table 4 'Y' value 26	float32	29f4	10740	2dp
UserLin.2.Y27	User linearisation table 4 'Y' value 27	float32	29f6	10742	2dp
UserLin.2.Y28	User linearisation table 4 'Y' value 28	float32	29f8	10744	2dp
UserLin.2.Y29	User linearisation table 4 'Y' value 29	float32	29fa	10746	2dp
UserLin.2.Y30	User linearisation table 4 'Y' value 30	float32	29fc	10748	2dp
UserLin.2.Y31	User linearisation table 4 'Y' value 31	float32	29fe	10750	2dp
UserLin.2.Y32	User linearisation table 4 'Y' value 32	float32	29ff	10751	2dp

Parameter path	Description	Type	Hex	Dec	Resolution
UserLin.3.NumberOfBreakpoints	Number of points in user linearisation table 32	uint8	2a80	10880	Not applicable
UserLin.3.X1	User linearisation table 3 'X' value 1	float32	2a81	10881	2dp
UserLin.3.X2	User linearisation table 3 'X' value 2	float32	2a83	10883	2dp
UserLin.3.X3	User linearisation table 3 'X' value 3	float32	2a85	10885	2dp
UserLin.3.X4	User linearisation table 3 'X' value 4	float32	2a87	10887	2dp
UserLin.3.X5	User linearisation table 3 'X' value 5	float32	2a89	10889	2dp
UserLin.3.X6	User linearisation table 3 'X' value 6	float32	2a8b	10891	2dp
UserLin.3.X7	User linearisation table 3 'X' value 7	float32	2a8d	10893	2dp
UserLin.3.X8	User linearisation table 3 'X' value 8	float32	2a8f	10895	2dp
UserLin.3.X9	User linearisation table 3 'X' value 9	float32	2a91	10897	2dp
UserLin.3.X10	User linearisation table 3 'X' value 10	float32	2a93	10899	2dp
UserLin.3.X11	User linearisation table 3 'X' value 11	float32	2a95	10901	2dp
UserLin.3.X12	User linearisation table 3 'X' value 12	float32	2a97	10903	2dp
UserLin.3.X13	User linearisation table 3 'X' value 13	float32	2a99	10905	2dp
UserLin.3.X14	User linearisation table 3 'X' value 14	float32	2a9b	10907	2dp
UserLin.3.X15	User linearisation table 3 'X' value 15	float32	2a9d	10909	2dp
UserLin.3.X16	User linearisation table 3 'X' value 16	float32	2a9f	10911	2dp
UserLin.3.X17	User linearisation table 3 'X' value 17	float32	2aa1	10913	2dp
UserLin.3.X18	User linearisation table 3 'X' value 18	float32	2aa3	10915	2dp
UserLin.3.X19	User linearisation table 3 'X' value 19	float32	2aa5	10917	2dp
UserLin.3.X20	User linearisation table 3 'X' value 20	float32	2aa7	10919	2dp
UserLin.3.X21	User linearisation table 3 'X' value 21	float32	2aa9	10921	2dp
UserLin.3.X22	User linearisation table 3 'X' value 22	float32	2aab	10923	2dp
UserLin.3.X23	User linearisation table 3 'X' value 23	float32	2aad	10925	2dp
UserLin.3.X24	User linearisation table 3 'X' value 24	float32	2aaf	10927	2dp
UserLin.3.X25	User linearisation table 3 'X' value 25	float32	2ab1	10929	2dp
UserLin.3.X26	User linearisation table 3 'X' value 26	float32	2ab3	10931	2dp
UserLin.3.X27	User linearisation table 3 'X' value 27	float32	2ab5	10933	2dp
UserLin.3.X28	User linearisation table 3 'X' value 28	float32	2ab7	10935	2dp
UserLin.3.X29	User linearisation table 3 'X' value 29	float32	2ab9	10937	2dp
UserLin.3.X30	User linearisation table 3 'X' value 30	float32	2abb	10939	2dp
UserLin.3.X31	User linearisation table 3 'X' value 31	float32	2abd	10941	2dp
UserLin.3.X32	User linearisation table 3 'X' value 32	float32	2abf	10943	2dp
UserLin.3.Y1	User linearisation table 4 'Y' value 1	float32	2a82	10882	2dp
UserLin.3.Y2	User linearisation table 4 'Y' value 2	float32	2a84	10884	2dp
UserLin.3.Y3	User linearisation table 4 'Y' value 3	float32	2a86	10886	2dp
UserLin.3.Y4	User linearisation table 4 'Y' value 4	float32	2a88	10888	2dp
UserLin.3.Y5	User linearisation table 4 'Y' value 5	float32	2a8a	10890	2dp
UserLin.3.Y6	User linearisation table 4 'Y' value 6	float32	2a8c	10892	2dp
UserLin.3.Y7	User linearisation table 4 'Y' value 7	float32	2a8e	10894	2dp
UserLin.3.Y8	User linearisation table 4 'Y' value 8	float32	2a90	10896	2dp
UserLin.3.Y9	User linearisation table 4 'Y' value 9	float32	2a92	10898	2dp
UserLin.3.Y10	User linearisation table 4 'Y' value 10	float32	2a94	10900	2dp
UserLin.3.Y11	User linearisation table 4 'Y' value 11	float32	2a96	10902	2dp
UserLin.3.Y12	User linearisation table 4 'Y' value 12	float32	2a98	10904	2dp
UserLin.3.Y13	User linearisation table 4 'Y' value 13	float32	2a9a	10906	2dp
UserLin.3.Y14	User linearisation table 4 'Y' value 14	float32	2a9c	10908	2dp
UserLin.3.Y15	User linearisation table 4 'Y' value 15	float32	2a9e	10910	2dp
UserLin.3.Y16	User linearisation table 4 'Y' value 16	float32	2aa0	10912	2dp
UserLin.3.Y17	User linearisation table 4 'Y' value 17	float32	2aa2	10914	2dp
UserLin.3.Y18	User linearisation table 4 'Y' value 18	float32	2aa4	10916	2dp
UserLin.3.Y19	User linearisation table 4 'Y' value 19	float32	2aa6	10918	2dp
UserLin.3.Y20	User linearisation table 4 'Y' value 20	float32	2aa8	10920	2dp
UserLin.3.Y21	User linearisation table 4 'Y' value 21	float32	2aaa	10922	2dp
UserLin.3.Y22	User linearisation table 4 'Y' value 22	float32	2aac	10924	2dp
UserLin.3.Y23	User linearisation table 4 'Y' value 23	float32	2aae	10926	2dp
UserLin.3.Y24	User linearisation table 4 'Y' value 24	float32	2ab0	10928	2dp
UserLin.3.Y25	User linearisation table 4 'Y' value 25	float32	2ab2	10930	2dp
UserLin.3.Y26	User linearisation table 4 'Y' value 26	float32	2ab4	10932	2dp
UserLin.3.Y27	User linearisation table 4 'Y' value 27	float32	2ab6	10934	2dp

Parameter path	Description	Type	Hex	Dec	Resolution
UserLin.3.Y29	User linearisation table 4 'Y' value 29	float32	2aba	10938	2dp
UserLin.3.Y30	User linearisation table 4 'Y' value 30	float32	2abc	10940	2dp
UserLin.3.Y31	User linearisation table 4 'Y' value 31	float32	2abe	10942	2dp
UserLin.3.Y32	User linearisation table 4 'Y' value 32	float32	2ac0	10944	2dp
UserLin.4.NumberOfBreakpoints	Number of points in user linearisation table 4	uint8	2b40	11072	Not applicable
UserLin.4.X1	User linearisation table 4 'X' value 1	float32	2b41	11073	2dp
UserLin.4.X2	User linearisation table 4 'X' value 2	float32	2b43	11075	2dp
UserLin.4.X3	User linearisation table 4 'X' value 3	float32	2b45	11077	2dp
UserLin.4.X4	User linearisation table 4 'X' value 4	float32	2b47	11079	2dp
UserLin.4.X5	User linearisation table 4 'X' value v5	float32	2b49	11081	2dp
UserLin.4.X6	User linearisation table 4 'X' value 6	float32	2b4b	11083	2dp
UserLin.4.X7	User linearisation table 4 'X' value 7	float32	2b4d	11085	2dp
UserLin.4.X8	User linearisation table 4 'X' value 8	float32	2b4f	11087	2dp
UserLin.4.X9	User linearisation table 4 'X' value 9	float32	2b51	11089	2dp
UserLin.4.X10	User linearisation table 4 'X' value 10	float32	2b53	11091	2dp
UserLin.4.X11	User linearisation table 4 'X' value 11	float32	2b55	11093	2dp
UserLin.4.X12	User linearisation table 4 'X' value 12	float32	2b57	11095	2dp
UserLin.4.X13	User linearisation table 4 'X' value 13	float32	2b59	11097	2dp
UserLin.4.X14	User linearisation table 4 'X' value 14	float32	2b5b	11099	2dp
UserLin.4.X15	User linearisation table 4 'X' value 15	float32	2b5d	11101	2dp
UserLin.4.X16	User linearisation table 4 'X' value 16	float32	2b5f	11103	2dp
UserLin.4.X17	User linearisation table 4 'X' value 17	float32	2b61	11105	2dp
UserLin.4.X18	User linearisation table 4 'X' value 18	float32	2b63	11107	2dp
UserLin.4.X19	User linearisation table 4 'X' value 19	float32	2b65	11109	2dp
UserLin.4.X20	User linearisation table 4 'X' value 20	float32	2b67	11111	2dp
UserLin.4.X21	User linearisation table 4 'X' value 21	float32	2b69	11113	2dp
UserLin.4.X22	User linearisation table 4 'X' value 22	float32	2b6b	11115	2dp
UserLin.4.X23	User linearisation table 4 'X' value 23	float32	2b6d	11117	2dp
UserLin.4.X24	User linearisation table 4 'X' value 24	float32	2b6f	11119	2dp
UserLin.4.X25	User linearisation table 4 'X' value 25	float32	2b71	11121	2dp
UserLin.4.X26	User linearisation table 4 'X' value 26	float32	2b73	11123	2dp
UserLin.4.X27	User linearisation table 4 'X' value 27	float32	2b75	11125	2dp
UserLin.4.X28	User linearisation table 4 'X' value 28	float32	2b77	11127	2dp
UserLin.4.X29	User linearisation table 4 'X' value 29	float32	2b79	11129	2dp
UserLin.4.X30	User linearisation table 4 'X' value 30	float32	2b7b	11131	2dp
UserLin.4.X31	User linearisation table 4 'X' value 31	float32	2b7d	11133	2dp
UserLin.4.X32	User linearisation table 4 'X' value 32	float32	2b7f	11135	2dp
UserLin.4.Y1	User linearisation table 4 'Y' value 1	float32	2b42	11074	2dp
UserLin.4.Y2	User linearisation table 4 'Y' value 2	float32	2b44	11076	2dp
UserLin.4.Y3	User linearisation table 4 'Y' value 3	float32	2b46	11078	2dp
UserLin.4.Y4	User linearisation table 4 'Y' value 4	float32	2b48	11080	2dp
UserLin.4.Y5	User linearisation table 4 'Y' value 5	float32	2b4a	11082	2dp
UserLin.4.Y6	User linearisation table 4 'Y' value 6	float32	2b4c	11084	2dp
UserLin.4.Y7	User linearisation table 4 'Y' value 7	float32	2b4e	11086	2dp
UserLin.4.Y8	User linearisation table 4 'Y' value 8	float32	2b50	11088	2dp
UserLin.4.Y9	User linearisation table 4 'Y' value 9	float32	2b52	11090	2dp
UserLin.4.Y10	User linearisation table 4 'Y' value 10	float32	2b54	11092	2dp
UserLin.4.Y11	User linearisation table 4 'Y' value 11	float32	2b56	11094	2dp
UserLin.4.Y12	User linearisation table 4 'Y' value 12	float32	2b58	11096	2dp
UserLin.4.Y13	User linearisation table 4 'Y' value 13	float32	2b5a	11098	2dp
UserLin.4.Y14	User linearisation table 4 'Y' value 14	float32	2b5c	11100	2dp
UserLin.4.Y15	User linearisation table 4 'Y' value 15	float32	2b5e	11102	2dp
UserLin.4.Y16	User linearisation table 4 'Y' value 16	float32	2b60	11104	2dp
UserLin.4.Y17	User linearisation table 4 'Y' value 17	float32	2b62	11106	2dp
UserLin.4.Y18	User linearisation table 4 'Y' value 18	float32	2b64	11108	2dp
UserLin.4.Y19	User linearisation table 4 'Y' value 19	float32	2b66	11110	2dp
UserLin.4.Y20	User linearisation table 4 'Y' value 20	float32	2b68	11112	2dp
UserLin.4.Y21	User linearisation table 4 'Y' value 21	float32	2b6a	11114	2dp
UserLin.4.Y22	User linearisation table 4 'Y' value 22	float32	2b6c	11116	2dp
UserLin.4.Y23	User linearisation table 4 'Y' value 23	float32	2b6e	11118	2dp
UserLin.4.Y24	User linearisation table 4 'Y' value 24	float32	2b70	11120	2dp

Parameter path	Description	Type	Hex	Dec	Resolution
UserLin.4.Y26	User linearisation table 4 'Y' value 26	float32	2b74	11124	2dp
UserLin.4.Y27	User linearisation table 4 'Y' value 27	float32	2b76	11126	2dp
UserLin.4.Y28	User linearisation table 4 'Y' value 28	float32	2b78	11128	2dp
UserLin.4.Y29	User linearisation table 4 'Y' value 29	float32	2b7a	11130	2dp
UserLin.4.Y30	User linearisation table 4 'Y' value 30	float32	2b7c	11132	2dp
UserLin.4.Y31	User linearisation table 4 'Y' value 31	float32	2b7e	11134	2dp
UserLin.4.Y32	User linearisation table 4 'Y' value 32	float32	2b80	11136	2dp
UsrVal.1.HighLimit	User Value High Limit	float32	2e8c	11916	Set by UsrVal.1.Resolution
UsrVal.1.LowLimit	User Value Low Limit	float32	2e8d	11917	Set by UsrVal.1.Resolution
UsrVal.1.Resolution	Result Resolution	uint8	2e90	11920	Not applicable
UsrVal.1.Status	User Value 1 Status (0 = Good (OK); 7 = Bad (Error))	bool	2e8f	11919	Not applicable
UsrVal.1.Units	Units of the value	string_t	68fc	26876	Not applicable
UsrVal.1.Val	The User Value	float32	2e8e	11918	Set by UsrVal.1.Resolution
UsrVal.2.HighLimit	User Value High Limit	float32	2e91	11921	Set by UsrVal.2.Resolution
UsrVal.2.LowLimit	User Value Low Limit	float32	2e92	11922	Set by UsrVal.2.Resolution
UsrVal.2.Resolution	Result Resolution	uint8	2e95	11925	Not applicable
UsrVal.2.Status	User Value 2 Status (0 = Good (OK); 7 = Bad (Error))	bool	2e94	11924	Not applicable
UsrVal.2.Units	Units of the value	string_t	6902	26882	Not applicable
UsrVal.2.Val	The User Value	float32	2e93	11923	Set by UsrVal.2.Resolution
UsrVal.3.HighLimit	User Value High Limit	float32	2e96	11926	Set by UsrVal.3.Resolution
UsrVal.3.LowLimit	User Value Low Limit	float32	2e97	11927	Set by UsrVal.3.Resolution
UsrVal.3.Resolution	Result Resolution	uint8	2e9a	11930	Not applicable
UsrVal.3.Status	User Value 3 Status (0 = Good (OK); 7 = Bad (Error))	bool	2e99	11929	Not applicable
UsrVal.3.Units	Units of the value	string_t	6908	26888	Not applicable
UsrVal.3.Val	The User Value	float32	2e98	11928	Set by UsrVal.3.Resolution
UsrVal.4.HighLimit	User Value High Limit	float32	2e9b	11931	Set by UsrVal.4.Resolution
UsrVal.4.LowLimit	User Value Low Limit	float32	2e9c	11932	Set by UsrVal.4.Resolution
UsrVal.4.Resolution	Result Resolution	uint8	2e9f	11935	Not applicable
UsrVal.4.Status	User Value 4 Status (0 = Good (OK); 7 = Bad (Error))	bool	2e9e	11934	Not applicable
UsrVal.4.Units	Units of the value	string_t	690e	26894	Not applicable
UsrVal.4.Val	The User Value	float32	2e9d	11933	Set by UsrVal.4.Resolution
UsrVal.5.HighLimit	User Value High Limit	float32	2ea0	11936	Set by UsrVal.5.Resolution
UsrVal.5.LowLimit	User Value Low Limit	float32	2ea1	11937	Set by UsrVal.5.Resolution
UsrVal.5.Resolution	Result Resolution	uint8	2ea4	11940	Not applicable
UsrVal.5.Status	User Value 5 Status (0 = Good (OK); 7 = Bad (Error))	bool	2ea3	11939	Not applicable
UsrVal.5.Units	Units of the value	string_t	6914	26900	Not applicable
UsrVal.5.Val	The User Value	float32	2ea2	11938	Set by UsrVal.5.Resolution
UsrVal.6.HighLimit	User Value High Limit	float32	2ea5	11941	Set by UsrVal.6.Resolution
UsrVal.6.LowLimit	User Value Low Limit	float32	2ea6	11942	Set by UsrVal.6.Resolution
UsrVal.6.Resolution	Result Resolution	uint8	2ea9	11945	Not applicable
UsrVal.6.Status	User Value 6 Status (0 = Good (OK); 7 = Bad (Error))	bool	2ea8	11944	Not applicable
UsrVal.6.Units	Units of the value	string_t	691a	26906	Not applicable
UsrVal.6.Val	The User Value	float32	2ea7	11943	Set by UsrVal.6.Resolution
UsrVal.7.HighLimit	User Value High Limit	float32	2eaa	11946	Set by UsrVal.7.Resolution
UsrVal.7.LowLimit	User Value Low Limit	float32	2eab	11947	Set by UsrVal.7.Resolution
UsrVal.7.Resolution	Result Resolution	uint8	2eae	11950	Not applicable
UsrVal.7.Status	User Value 7 Status (0 = Good (OK); 7 = Bad (Error))	bool	2ead	11949	Not applicable
UsrVal.7.Units	Units of the value	string_t	6920	26912	Not applicable
UsrVal.7.Val	The User Value	float32	2eac	11948	Set by UsrVal.7.Resolution
UsrVal.8.HighLimit	User Value High Limit	float32	2eaf	11951	Set by UsrVal.8.Resolution
UsrVal.8.LowLimit	User Value Low Limit	float32	2eb0	11952	Set by UsrVal.8.Resolution
UsrVal.8.Resolution	Result Resolution	uint8	2eb3	11955	Not applicable
UsrVal.8.Status	User Value 8 Status (0 = Good (OK); 7 = Bad (Error))	bool	2eb2	11954	Not applicable

Parameter path	Description	Type	Hex	Dec	Resolution
UsrVal.8.Val	The User Value	float32	2eb1	11953	Set by UsrVal.8.Resolution
UsrVal.9.HighLimit	User Value High Limit	float32	2eb4	11956	Set by UsrVal.9.Resolution
UsrVal.9.LowLimit	User Value Low Limit	float32	2eb5	11957	Set by UsrVal.9.Resolution
UsrVal.9.Resolution	Result Resolution	uint8	2eb8	11960	Not applicable
UsrVal.9.Status	User Value 9 Status (0 = Good (OK); 7 = Bad (Error))	bool	2eb7	11959	Not applicable
UsrVal.9.Units	Units of the value	string_t	692c	26924	Not applicable
UsrVal.9.Val	The User Value	float32	2eb6	11958	Set by UsrVal.9.Resolution
UsrVal.10.HighLimit	User Value High Limit	float32	2eb9	11961	Set by UsrVal.10.Resolution
UsrVal.10.LowLimit	User Value Low Limit	float32	2eba	11962	Set by UsrVal.10.Resolution
UsrVal.10.Resolution	Result Resolution	uint8	2ebd	11965	Not applicable
UsrVal.10.Status	User Value 10 Status (0 = Good (OK); 7 = Bad (Error))	bool	2ebc	11964	Not applicable
UsrVal.10.Units	Units of the value	string_t	6932	26930	Not applicable
UsrVal.10.Val	The User Value	float32	2ebb	11963	Set by UsrVal.10.Resolution
UsrVal.11.HighLimit	User Value High Limit	float32	2ebe	11966	Set by UsrVal.11.Resolution
UsrVal.11.LowLimit	User Value Low Limit	float32	2ebf	11967	Set by UsrVal.11.Resolution
UsrVal.11.Resolution	Result Resolution	uint8	2ec2	11970	Not applicable
UsrVal.11.Status	User Value 11 Status (0 = Good (OK); 7 = Bad (Error))	bool	2ec1	11969	Not applicable
UsrVal.11.Units	Units of the value	string_t	6938	26936	Not applicable
UsrVal.11.Val	The User Value	float32	2ec0	11968	Set by UsrVal.11.Resolution
UsrVal.12.HighLimit	User Value High Limit	float32	2ec3	11971	Set by UsrVal.12.Resolution
UsrVal.12.LowLimit	User Value Low Limit	float32	2ec4	11972	Set by UsrVal.12.Resolution
UsrVal.12.Resolution	Result Resolution	uint8	2ec7	11975	Not applicable
UsrVal.12.Status	User Value 12 Status (0 = Good (OK); 7 = Bad (Error))	bool	2ec6	11974	Not applicable
UsrVal.12.Units	Units of the value	string_t	693e	26942	Not applicable
UsrVal.12.Val	The User Value	float32	2ec5	11973	Set by UsrVal.12.Resolution
VirtualChannel.1.Alarm1.Acknowledge	1 = acknowledge alarm	bool	01c0	448	Not applicable
VirtualChannel.1.Alarm1.Acknowledgement	1 = alarm acknowledged	bool	1c50	7248	Not applicable
VirtualChannel.1.Alarm1.Active	1 = alarm source active, or safe but not ack'd	bool	1c4b	7243	Not applicable
VirtualChannel.1.Alarm1.Amount	Rate-of-change alarm 'Amount'	float32	1c48	7240	Same as VirtualChannel.1.Main.PV
VirtualChannel.1.Alarm1.AverageTime	Rate-of-change alarm 'Average time'	time_t	1c4a	7242	Set by Network.Modbus.TimeFormat
VirtualChannel.1.Alarm1.Block	0 = Blocking alarms off; 1 = Blocking alarms on	uint8	1c42	7234	Not applicable
VirtualChannel.1.Alarm1.ChangeTime	Rate-of-change alarm 'Change Time'	uint8	1c49	7241	Not applicable
VirtualChannel.1.Alarm1.Deviation	Deviation alarm 'Deviation Value'	float32	1c47	7239	Same as VirtualChannel.1.Main.PV
VirtualChannel.1.Alarm1.Dwell	Alarm dwell time	time_t	1c45	7237	Set by Network.Modbus.TimeFormat
VirtualChannel.1.Alarm1.Hysteresis	Alarm hysteresis value	float32	1c44	7236	Same as VirtualChannel.1.Main.PV
VirtualChannel.1.Alarm1.Inactive	1 = alarm source safe and ack'd (if necessary)	bool	1c4e	7246	Not applicable
VirtualChannel.1.Alarm1.Inhibit	1 = alarm inhibited	bool	1c51	7249	Not applicable
VirtualChannel.1.Alarm1.Latch	Alarm latch type (0 = None; 1 = Auto; 2 = Manual; 3 = Trigger)	uint8	1c41	7233	Not applicable
VirtualChannel.1.Alarm1.NotAcknowledged	1 = alarm has not been acknowledged	bool	1c4f	7247	Not applicable
VirtualChannel.1.Alarm1.Reference	Deviation alarm 'Reference' value	float32	1c46	7238	Same as VirtualChannel.1.Main.PV
VirtualChannel.1.Alarm1.Status	Indication of the active and acknowledge status 0 = Unacknowledged 1 = None 2 = Active 3 = Inactive 4 = Acknowledged	uint8	0122	290	Not applicable
VirtualChannel.1.Alarm1.Threshold	Alarm trigger threshold	float32	1c43	7235	Same as VirtualChannel.1.Main.PV
VirtualChannel.1.Alarm1.Type	Alarm type 0 = None 1 = Abs High 2 = Abs Low 3 = Dev high 4 = Dev Low 5 = Dev band 6 = ROC rising 7 = ROC falling 10 = Dig Off 11 = Dig High 12 = Dig Low	uint8	1c40	7232	Not applicable
VirtualChannel.1.Alarm2.Acknowledge	1 = acknowledge alarm	bool	01c1	449	Not applicable
VirtualChannel.1.Alarm2.Acknowledgement	1 = alarm acknowledged	bool	1c70	7280	Not applicable
VirtualChannel.1.Alarm2.Active	1 = alarm source active, or safe but not ack'd	bool	1c6b	7275	Not applicable
VirtualChannel.1.Alarm2.Amount	Rate-of-change alarm 'Amount'	float32	1c68	7272	Same as VirtualChannel.1.Main.PV
VirtualChannel.1.Alarm2.AverageTime	Rate-of-change alarm 'Average time'	time_t	1c6a	7274	Set by Network.Modbus.TimeFormat
VirtualChannel.1.Alarm2.Block	0 = Blocking alarms off; 1 = Blocking alarms on	uint8	1c62	7266	Not applicable
VirtualChannel.1.Alarm2.ChangeTime	Rate-of-change alarm 'Change Time'	uint8	1c69	7273	Not applicable
VirtualChannel.1.Alarm2.Deviation	Deviation alarm 'Deviation Value'	float32	1c67	7271	Same as VirtualChannel.1.Main.PV

Parameter path	Description	Type	Hex	Dec	Resolution
VirtualChannel.1.Alarm2.Hysteresis	Alarm hysteresis value	float32	1c64	7268	Same as VirtualChannel.1.Main.PV
VirtualChannel.1.Alarm2.Inactive	1 = alarm source safe and ack'd (if necessary)	bool	1c6e	7278	Not applicable
VirtualChannel.1.Alarm2.Inhibit	1 = alarm inhibited	bool	1c71	7281	Not applicable
VirtualChannel.1.Alarm2.Latch	As VirtualChannel1.Alarm1.Latch	uint8	1c61	7265	Not applicable
VirtualChannel.1.Alarm2.NotAcknowledged	1 = alarm has not been acknowledged	bool	1c6f	7279	Not applicable
VirtualChannel.1.Alarm2.Reference	Deviation alarm 'Reference' value	float32	1c66	7270	Same as VirtualChannel.1.Main.PV
VirtualChannel.1.Alarm2.Status	As VirtualChannel1.Alarm1.Status	uint8	0123	291	Not applicable
VirtualChannel.1.Alarm2.Threshold	Alarm trigger threshold	float32	1c63	7267	Same as VirtualChannel.1.Main.PV
VirtualChannel.1.Alarm2.Type	As VirtualChannel1.Alarm1.Type	uint8	1c60	7264	Not applicable
VirtualChannel.1.Main.Descriptor	Virtual Channel descriptor	string_t	4b00	19200	Not applicable
VirtualChannel.1.Main.Disable	1 = Virtual channel disabled	bool	1c23	7203	Not applicable
VirtualChannel.1.Main.HighCutOff	High cut off value for totalisers and counters	float32	1c05	7173	Set by VirtualChannel.1.Main.Resolution
VirtualChannel.1.Main.Input1	Input 1 value	float32	1c07	7175	Set by VirtualChannel.1.Main.Resolution
VirtualChannel.1.Main.Input2	Input 2 value	float32	1c08	7176	Set by VirtualChannel.1.Main.Resolution
VirtualChannel.1.Main.LowCutOff	Low cutoff value for totalisers and counters	float32	1c04	7172	Set by VirtualChannel.1.Main.Resolution
VirtualChannel.1.Main.ModbusInput	Modbus input value	float32	1c06	7174	Set by VirtualChannel.1.Main.Resolution
VirtualChannel.1.Main.Operation	Specifies the operation of the virtual channel 0 = Off 2 = Add 3 = Subtract 4 = Multiply 5 = Divide 6 = Group avg 7 = Group min 8 = Group max 9 = Modbus i/p 11 = Copy 20 = Grp min latch 21 = Grp max latch 34 = Chan max 35 = Chan min 36 = Chan avg 43 = Config rev 64 = Off 65 = On 80 = Off 81 = On	uint8	1c01	7169	Not applicable
VirtualChannel.1.Main.Period	The time period over which the calculation is made	int32	1c0a	7178	
VirtualChannel.1.Main.Preset	Initiate preset. 0 = No; 1 = Yes	bool	1c0c	7180	Not applicable
VirtualChannel.1.Main.PresetValue	The preset value	float32	1c0d	7181	Set by VirtualChannel.1.Main.Resolution
VirtualChannel.1.Main.PV	The virtual channel output value	float32	0120	288	Set by VirtualChannel.1.Main.Resolution
VirtualChannel.1.Main.Reset	Initiate reset. 0 = No; 1 = Yes	bool	1c0b	7179	Not applicable
VirtualChannel.1.Main.Resolution	Number of decimal places (0 to 6)	uint8	1c02	7170	Not applicable
VirtualChannel.1.Main.Rollover	A pulse signal to indicate PV (output) has just rolled over	bool	1c11	7185	Not applicable
VirtualChannel.1.Main.RolloverValue	Rollover value	float32	1c12	7186	Set by VirtualChannel.1.Main.Resolution
VirtualChannel.1.Main.Status	Virtual Channel output status 0 = Good 1 = Off 2 = Over range 3 = Under range 4 = HW error 5 = Ranging 6 = Overflow 7 = bad 8 = HW exceeded 9 = No data 12 = Comms channel error	uint8	0121	289	Not applicable
VirtualChannel.1.Main.TimeRemaining	Time remaining before the calculation is made	time_t	1c09	7177	Set by Network.Modbus.TimeFormat
VirtualChannel.1.Main.Trigger	Increment/decrement counter. 0 = No; 1 = Yes	bool	1c0e	7182	Not applicable
VirtualChannel.1.Main.Type	Specifies the type of virtual channel 1 = Maths; 2 = Totaliser; 3 = Counter	uint8	1c00	7168	Not applicable
VirtualChannel.1.Main.Units	Units descriptor	string_t	4b15	19221	Not applicable
VirtualChannel.1.Main.UnitsScaler	Units scaler for totalisers	float32	1c03	7171	1dp
VirtualChannel.1.Trend.Colour	Configures the trend colour for this virtual channel 0 = Red 1 = Blue 2 = Green 3 = Honey 4 = Violet 5 = Russet 6 = Dark blue 7 = Jade 8 = Magenta 9 = Dusky rose 10 = Yellow 11 = Powder blue 12 = Dark red 13 = Avocado 14 = Indigo 15 = Dark brown 16 = Aegean 17 = Cyan 18 = Aubergine 19 = Dark orange 20 = Pale yellow 21 = Hyacinth 22 = Dark green 23 = Sugar pink 24 = Bluebell 25 = Orange 26 = Pink 27 = Buttersilk 28 = Terracotta 29 = Blue babe 30 = Lime 31 = Blue jive 32 = Cucumber 33 = Eurogreen 34 = Wheatgerm 35 = Sea Blue 36 = Ginger 37 = Aqua pool 38 = Pale red 39 = Pale blue 40 = Lilac 41 = Sky blue 42 = Wild moss 43 = Turquoise 44 = Pale green 45 = Coffee 49 = Dark Grey 53 = Light grey	uint8	1c20	7200	Not applicable
VirtualChannel.1.Trend.SpanHigh	Specifies the highest PV (output value) to be displayed	float32	1c22	7202	Same as VirtualChannel.1.Main.PV
VirtualChannel.1.Trend.SpanLow	Specifies the lowest PV (output value) to be displayed	float32	1c21	7201	Same as VirtualChannel.1.Main.PV
VirtualChannel.2.Alarm1.Acknowledge	1 = acknowledge alarm	bool	01c2	450	Not applicable
VirtualChannel.2.Alarm1.Acknowledgement	1 = alarm acknowledged	bool	1cd0	7376	Not applicable
VirtualChannel.2.Alarm1.Active	1 = alarm source active, or safe but not ack'd	bool	1ccb	7371	Not applicable
VirtualChannel.2.Alarm1.Amount	Rate-of-change alarm 'Amount'	float32	1cc8	7368	Same as VirtualChannel.2.Main.PV
VirtualChannel.2.Alarm1.AverageTime	Rate-of-change alarm 'Average time'	time_t	1cca	7370	Set by Network.Modbus.TimeFormat
VirtualChannel.2.Alarm1.Block	0 = Blocking alarms off; 1 = Blocking alarms on	uint8	1cc2	7362	Not applicable
VirtualChannel.2.Alarm1.ChangeTime	Rate-of-change alarm 'Change Time'	uint8	1cc9	7369	Not applicable
VirtualChannel.2.Alarm1.Deviation	Deviation alarm 'Deviation Value'	float32	1cc7	7367	Same as VirtualChannel.2.Main.PV
VirtualChannel.2.Alarm1.Dwell	Alarm dwell time	time_t	1ccf	7375	Set by Network.Modbus.TimeFormat

Parameter path	Description	Type	Hex	Dec	Resolution
VirtualChannel.2.Alarm1.Inactive	1 = alarm source safe and ack'd (if necessary)	bool	1cce	7374	Not applicable
VirtualChannel.2.Alarm1.Inhibit	1 = alarm inhibited	bool	1cd1	7377	Not applicable
VirtualChannel.2.Alarm1.Latch	As VirtualChannel1.Alarm1.Latch	uint8	1cc1	7361	Not applicable
VirtualChannel.2.Alarm1.NotAcknowledged	1 = alarm has not been acknowledged	bool	1ccf	7375	Not applicable
VirtualChannel.2.Alarm1.Reference	Deviation alarm 'Reference' value	float32	1cc6	7366	Same as VirtualChannel.2.Main.PV
VirtualChannel.2.Alarm1.Status	As VirtualChannel1.Alarm1.Status	uint8	0126	294	Not applicable
VirtualChannel.2.Alarm1.Threshold	Alarm trigger threshold	float32	1cc3	7363	Same as VirtualChannel.2.Main.PV
VirtualChannel.2.Alarm1.Type	As VirtualChannel1.Alarm1.Type	uint8	1cc0	7360	Not applicable
VirtualChannel.2.Alarm2.Acknowledge	1 = acknowledge alarm	bool	01c3	451	Not applicable
VirtualChannel.2.Alarm2.Acknowledgement	1 = alarm acknowledged	bool	1cf0	7408	Not applicable
VirtualChannel.2.Alarm2.Active	1 = alarm source active, or safe but not ack'd	bool	1ceb	7403	Not applicable
VirtualChannel.2.Alarm2.Amount	Rate-of-change alarm 'Amount'	float32	1ce8	7400	Same as VirtualChannel.2.Main.PV
VirtualChannel.2.Alarm2.AverageTime	Rate-of-change alarm 'Average time'	time_t	1cea	7402	Set by Network.Modbus.TimeFormat
VirtualChannel.2.Alarm2.Block	0 = Blocking alarms off; 1 = Blocking alarms on	uint8	1ce2	7394	Not applicable
VirtualChannel.2.Alarm2.ChangeTime	Rate-of-change alarm 'Change Time'	uint8	1ce9	7401	Not applicable
VirtualChannel.2.Alarm2.Deviation	Deviation alarm 'Deviation Value'	float32	1ce7	7399	Same as VirtualChannel.2.Main.PV
VirtualChannel.2.Alarm2.Dwell	Alarm dwell time	time_t	1ce5	7397	Set by Network.Modbus.TimeFormat
VirtualChannel.2.Alarm2.Hysteresis	Alarm hysteresis value	float32	1ce4	7396	Same as VirtualChannel.2.Main.PV
VirtualChannel.2.Alarm2.Inactive	1 = alarm source safe and ack'd (if necessary)	bool	1cee	7406	Not applicable
VirtualChannel.2.Alarm2.Inhibit	1 = alarm inhibited	bool	1cf1	7409	Not applicable
VirtualChannel.2.Alarm2.Latch	As VirtualChannel1.Alarm1.Latch	uint8	1ce1	7393	Not applicable
VirtualChannel.2.Alarm2.NotAcknowledged	1 = alarm has not been acknowledged	bool	1cef	7407	Not applicable
VirtualChannel.2.Alarm2.Reference	Deviation alarm 'Reference' value	float32	1ce6	7398	Same as VirtualChannel.2.Main.PV
VirtualChannel.2.Alarm2.Status	As VirtualChannel1.Alarm1.Status	uint8	0127	295	Not applicable
VirtualChannel.2.Alarm2.Threshold	Alarm trigger threshold	float32	1ce3	7395	Same as VirtualChannel.2.Main.PV
VirtualChannel.2.Alarm2.Type	As VirtualChannel1.Alarm1.Type	uint8	1ce0	7392	Not applicable
VirtualChannel.2.Main.Descriptor	Virtual Channel descriptor	string_t	4b1b	19227	Not applicable
VirtualChannel.2.Main.Disable	1 = Virtual channel disabled	bool	1ca3	7331	Not applicable
VirtualChannel.2.Main.HighCutOff	The highest input value that will be totalised/counted	float32	1c85	7301	Set by VirtualChannel.2.Main.Resolution
VirtualChannel.2.Main.Input1	Input 1 value	float32	1c87	7303	Set by VirtualChannel.2.Main.Resolution
VirtualChannel.2.Main.Input2	Input 2 value	float32	1c88	7304	Set by VirtualChannel.2.Main.Resolution
VirtualChannel.2.Main.LowCutOff	The lowest input value that will be totalised/counted	float32	1c84	7300	Set by VirtualChannel.2.Main.Resolution
VirtualChannel.2.Main.ModbusInput	Modbus input value	float32	1c86	7302	Set by VirtualChannel.2.Main.Resolution
VirtualChannel.2.Main.Operation	As VirtualChannel1.Main.Operation	uint8	1c81	7297	Not applicable
VirtualChannel.2.Main.Period	The time period over which the calculation is made	int32	1c8a	7306	Not applicable
VirtualChannel.2.Main.Preset	Initiate preset. 0 = No; 1 = Yes	bool	1c8c	7308	Not applicable
VirtualChannel.2.Main.PresetValue	The Preset value	float32	1c8d	7309	Set by VirtualChannel.2.Main.Resolution
VirtualChannel.2.Main.PV	The virtual channel output value	float32	0124	292	Set by VirtualChannel.2.Main.Resolution
VirtualChannel.2.Main.Reset	Initiate reset. 0 = No; 1 = Yes	bool	1c8b	7307	Not applicable
VirtualChannel.2.Main.Resolution	Specifies the resolution/number of decimal places	uint8	1c82	7298	Not applicable
VirtualChannel.2.Main.Rollover	A pulse signal to indicate PV (output) has just rolled over	bool	1c91	7313	Not applicable
VirtualChannel.2.Main.RolloverValue	Rollover value	float32	1c92	7314	Set by VirtualChannel.2.Main.Resolution
VirtualChannel.2.Main.Status	As VirtualChannel1.Main.Status	uint8	0125	293	Not applicable
VirtualChannel.2.Main.TimeRemaining	Time remaining before the calculation is made	time_t	1c89	7305	Set by Network.Modbus.TimeFormat
VirtualChannel.2.Main.Trigger	Increment/decrement counter. 0 = No; 1 = Yes	bool	1c8e	7310	Not applicable
VirtualChannel.2.Main.Type	As VirtualChannel1.Main.Type	uint8	1c80	7296	Not applicable
VirtualChannel.2.Main.Units	Units descriptor	string_t	4b30	19248	Not applicable
VirtualChannel.2.Main.UnitsScaler	Units scaler for totalisers	float32	1c83	7299	1dp
VirtualChannel.2.Trend.Colour	As VirtualChannel1.Trend.Colour	uint8	1ca0	7328	Not applicable
VirtualChannel.2.Trend.SpanHigh	Specifies the highest PV (output value) to be displayed	float32	1ca2	7330	Same as VirtualChannel.2.Main.PV
VirtualChannel.2.Trend.SpanLow	Specifies the lowest PV (output value) to be displayed	float32	1ca1	7329	Same as VirtualChannel.2.Main.PV
VirtualChannel.3.Alarm1.Acknowledge	1 = acknowledge alarm	bool	01c4	452	Not applicable
VirtualChannel.3.Alarm1.Acknowledgement	1 = alarm acknowledged	bool	1d50	7504	Not applicable
VirtualChannel.3.Alarm1.Active	1 = alarm source active, or safe but not ack'd	bool	1d4b	7499	Not applicable
VirtualChannel.3.Alarm1.Amount	Rate-of-change alarm 'Amount'	float32	1d48	7496	Same as VirtualChannel.3.Main.PV
VirtualChannel.3.Alarm1.AverageTime	Rate-of-change alarm 'Average time'	time_t	1d4a	7498	Set by Network.Modbus.TimeFormat
VirtualChannel.3.Alarm1.Block	0 = Blocking alarms off; 1 = Blocking alarms on	uint8	1d42	7490	Not applicable
VirtualChannel.3.Alarm1.ChangeTime	Rate-of-change alarm 'Change Time'	uint8	1d49	7497	Not applicable
VirtualChannel.3.Alarm1.Deviation	Deviation alarm 'Deviation Value'	float32	1d47	7495	Same as VirtualChannel.3.Main.PV
VirtualChannel.3.Alarm1.Dwell	Alarm dwell time	time_t	1d4e	7499	Set by Network.Modbus.TimeFormat

Parameter path	Description	Type	Hex	Dec	Resolution
VirtualChannel.3.Alarm1.Inactive	1 = alarm source safe and ack'd (if necessary)	bool	1d4e	7502	Not applicable
VirtualChannel.3.Alarm1.Inhibit	1 = alarm inhibited	bool	1d51	7505	Not applicable
VirtualChannel.3.Alarm1.Latch	As VirtualChannel1.Alarm1.Latch	uint8	1d41	7489	Not applicable
VirtualChannel.3.Alarm1.NotAcknowledged	1 = alarm has not been acknowledged	bool	1d4f	7503	Not applicable
VirtualChannel.3.Alarm1.Reference	Deviation alarm 'Reference' value	float32	1d46	7494	Same as VirtualChannel.3.Main.PV
VirtualChannel.3.Alarm1.Status	As VirtualChannel1.Alarm1.Status	uint8	012a	298	Not applicable
VirtualChannel.3.Alarm1.Threshold	Alarm trigger threshold	float32	1d43	7491	Same as VirtualChannel.3.Main.PV
VirtualChannel.3.Alarm1.Type	As VirtualChannel1.Alarm1.Type	uint8	1d40	7488	Not applicable
VirtualChannel.3.Alarm2.Acknowledge	1 = acknowledge alarm	bool	01c5	453	Not applicable
VirtualChannel.3.Alarm2.Acknowledgement	1 = alarm acknowledged	bool	1d70	7536	Not applicable
VirtualChannel.3.Alarm2.Active	1 = alarm source active, or safe but not ack'd	bool	1d6b	7531	Not applicable
VirtualChannel.3.Alarm2.Amount	Rate-of-change alarm 'Amount'	float32	1d68	7528	Same as VirtualChannel.3.Main.PV
VirtualChannel.3.Alarm2.AverageTime	Rate-of-change alarm 'Average time'	time_t	1d6a	7530	Set by Network.Modbus.TimeFormat
VirtualChannel.3.Alarm2.Block	0 = Blocking alarms off; 1 = Blocking alarms on	uint8	1d62	7522	Not applicable
VirtualChannel.3.Alarm2.ChangeTime	Rate-of-change alarm 'Change Time'	uint8	1d69	7529	Not applicable
VirtualChannel.3.Alarm2.Deviation	Deviation alarm 'Deviation Value'	float32	1d67	7527	Same as VirtualChannel.3.Main.PV
VirtualChannel.3.Alarm2.Dwell	Alarm dwell time	time_t	1d65	7525	Set by Network.Modbus.TimeFormat
VirtualChannel.3.Alarm2.Hysteresis	Alarm hysteresis value	float32	1d64	7524	Same as VirtualChannel.3.Main.PV
VirtualChannel.3.Alarm2.Inactive	1 = alarm source safe and ack'd (if necessary)	bool	1d6e	7534	Not applicable
VirtualChannel.3.Alarm2.Inhibit	1 = alarm inhibited	bool	1d71	7537	Not applicable
VirtualChannel.3.Alarm2.Latch	As VirtualChannel1.Alarm1.Latch	uint8	1d61	7521	Not applicable
VirtualChannel.3.Alarm2.NotAcknowledged	1 = alarm has not been acknowledged	bool	1d6f	7535	Not applicable
VirtualChannel.3.Alarm2.Reference	Deviation alarm 'Reference' value	float32	1d66	7526	Same as VirtualChannel.3.Main.PV
VirtualChannel.3.Alarm2.Status	As VirtualChannel1.Alarm1.Status	uint8	012b	299	Not applicable
VirtualChannel.3.Alarm2.Threshold	Alarm trigger threshold	float32	1d63	7523	Same as VirtualChannel.3.Main.PV
VirtualChannel.3.Alarm2.Type	As VirtualChannel1.Alarm1.Type	uint8	1d60	7520	Not applicable
VirtualChannel.3.Main.Descriptor	Virtual Channel descriptor	string_t	4b36	19254	Not applicable
VirtualChannel.3.Main.Disable	1 = Virtual channel disabled	bool	1d23	7459	Not applicable
VirtualChannel.3.Main.HighCutOff	The highest input value that will be totalised/counted	float32	1d05	7429	Set by VirtualChannel.3.Main.Resolution
VirtualChannel.3.Main.Input1	Input 1	float32	1d07	7431	Set by VirtualChannel.3.Main.Resolution
VirtualChannel.3.Main.Input2	Input 2	float32	1d08	7432	Set by VirtualChannel.3.Main.Resolution
VirtualChannel.3.Main.LowCutOff	The lowest input value that will be totalised/counted	float32	1d04	7428	Set by VirtualChannel.3.Main.Resolution
VirtualChannel.3.Main.ModbusInput	Modbus input value	float32	1d06	7430	Set by VirtualChannel.3.Main.Resolution
VirtualChannel.3.Main.Operation	As VirtualChannel1.Main.Operation	uint8	1d01	7425	Not applicable
VirtualChannel.3.Main.Period	The time period over which the calculation is made	int32	1d0a	7434	Not applicable
VirtualChannel.3.Main.Preset	Initiate preset. 0 = No; 1 = Yes	bool	1d0c	7436	Not applicable
VirtualChannel.3.Main.PresetValue	The Preset value	float32	1d0d	7437	Set by VirtualChannel.3.Main.Resolution
VirtualChannel.3.Main.PV	The virtual channel output value	float32	0128	296	Set by VirtualChannel.3.Main.Resolution
VirtualChannel.3.Main.Reset	Initiate reset. 0 = No; 1 = Yes	bool	1d0b	7435	Not applicable
VirtualChannel.3.Main.Resolution	Number of decimal places (0 to 6)	uint8	1d02	7426	Not applicable
VirtualChannel.3.Main.Rollover	A pulse signal to indicate PV (output) has just rolled over	bool	1d11	7441	Not applicable
VirtualChannel.3.Main.RolloverValue	Rollover value	float32	1d12	7442	Set by VirtualChannel.3.Main.Resolution
VirtualChannel.3.Main.Status	As VirtualChannel1.Main.Status	uint8	0129	297	Not applicable
VirtualChannel.3.Main.TimeRemaining	Time remaining before the calculation is made	time_t	1d09	7433	Set by Network.Modbus.TimeFormat
VirtualChannel.3.Main.Trigger	Increment/decrement counter. 0 = No; 1 = Yes	bool	1d0e	7438	Not applicable
VirtualChannel.3.Main.Type	As VirtualChannel1.Main.Type	uint8	1d00	7424	Not applicable
VirtualChannel.3.Main.Units	Units descriptor	string_t	4b4b	19275	Not applicable
VirtualChannel.3.Main.UnitsScaler	Units scaler for totalisers	float32	1d03	7427	1dp
VirtualChannel.3.Trend.Colour	As VirtualChannel1.Trend.Colour	uint8	1d20	7456	Not applicable
VirtualChannel.3.Trend.SpanHigh	Specifies the highest PV (output value) to be displayed	float32	1d22	7458	Same as VirtualChannel.3.Main.PV
VirtualChannel.3.Trend.SpanLow	Specifies the lowest PV (output value) to be displayed	float32	1d21	7457	Same as VirtualChannel.3.Main.PV
VirtualChannel.4.Alarm1.Acknowledge	1 = acknowledge alarm	bool	01c6	454	Not applicable
VirtualChannel.4.Alarm1.Acknowledgement	1 = alarm acknowledged	bool	1dd0	7632	Not applicable
VirtualChannel.4.Alarm1.Active	1 = alarm source active, or safe but not ack'd	bool	1dcb	7627	Not applicable
VirtualChannel.4.Alarm1.Amount	Rate-of-change alarm 'Amount'	float32	1dc8	7624	Same as VirtualChannel.4.Main.PV
VirtualChannel.4.Alarm1.AverageTime	Rate-of-change alarm 'Average time'	time_t	1dca	7626	Set by Network.Modbus.TimeFormat
VirtualChannel.4.Alarm1.Block	0 = Blocking alarms off; 1 = Blocking alarms on	uint8	1dc2	7618	Not applicable
VirtualChannel.4.Alarm1.ChangeTime	Rate-of-change alarm 'Change Time'	uint8	1dc9	7625	Not applicable
VirtualChannel.4.Alarm1.Deviation	Deviation alarm 'Deviation Value'	float32	1dc7	7623	Same as VirtualChannel.4.Main.PV
VirtualChannel.4.Alarm1.Dwell	Alarm dwell time	time_t	1dc5	7621	Set by Network.Modbus.TimeFormat
VirtualChannel.4.Alarm1.Hysteresis	Alarm hysteresis value	float32	1dc4	7620	Same as VirtualChannel.4.Main.PV

Parameter path	Description	Type	Hex	Dec	Resolution
VirtualChannel.4.Alarm1.Inhibit	1 = alarm inhibited	bool	1dd1	7633	Not applicable
VirtualChannel.4.Alarm1.Latch	As VirtualChannel1.Alarm1.Latch	uint8	1dc1	7617	Not applicable
VirtualChannel.4.Alarm1.NotAcknowledged	1 = alarm has not been acknowledged	bool	1dcf	7631	Not applicable
VirtualChannel.4.Alarm1.Reference	Deviation alarm 'Reference' value	float32	1dc6	7622	Same as VirtualChannel.4.Main.PV
VirtualChannel.4.Alarm1.Status	As VirtualChannel1.Alarm1.Status	uint8	012e	302	Not applicable
VirtualChannel.4.Alarm1.Threshold	Alarm trigger threshold	float32	1dc3	7619	Same as VirtualChannel.4.Main.PV
VirtualChannel.4.Alarm1.Type	As VirtualChannel1.Alarm1.Type	uint8	1dc0	7616	Not applicable
VirtualChannel.4.Alarm2.Acknowledge	1 = acknowledge alarm	bool	01c7	455	Not applicable
VirtualChannel.4.Alarm2.Acknowledgement	1 = alarm acknowledged	bool	1df0	7664	Not applicable
VirtualChannel.4.Alarm2.Active	1 = alarm source active, or safe but not ack'd	bool	1deb	7659	Not applicable
VirtualChannel.4.Alarm2.Amount	Rate-of-change alarm 'Amount'	float32	1de8	7656	Same as VirtualChannel.4.Main.PV
VirtualChannel.4.Alarm2.AverageTime	Rate-of-change alarm 'Average time'	time_t	1dea	7658	Set by Network.Modbus.TimeFormat
VirtualChannel.4.Alarm2.Block	0 = Blocking alarms off; 1 = Blocking alarms on	uint8	1de2	7650	Not applicable
VirtualChannel.4.Alarm2.ChangeTime	Rate-of-change alarm 'Change Time'	uint8	1de9	7657	Not applicable
VirtualChannel.4.Alarm2.Deviation	Deviation alarm 'Deviation Value'	time_t	1de5	7653	Set by Network.Modbus.TimeFormat
VirtualChannel.4.Alarm2.Hysteresis	Alarm hysteresis value	float32	1de4	7652	Same as VirtualChannel.4.Main.PV
VirtualChannel.4.Alarm2.Inactive	1 = alarm source safe and ack'd (if necessary)	bool	1dee	7662	Not applicable
VirtualChannel.4.Alarm2.Inhibit	1 = alarm inhibited	bool	1df1	7665	Not applicable
VirtualChannel.4.Alarm2.Latch	As VirtualChannel1.Alarm1.Latch	uint8	1de1	7649	Not applicable
VirtualChannel.4.Alarm2.NotAcknowledged	1 = alarm has not been acknowledged	bool	1def	7663	Not applicable
VirtualChannel.4.Alarm2.Reference	Deviation alarm 'Reference' value	float32	1de6	7654	Same as VirtualChannel.4.Main.PV
VirtualChannel.4.Alarm2.Status	As VirtualChannel1.Alarm1.Status	uint8	012f	303	Not applicable
VirtualChannel.4.Alarm2.Threshold	Alarm trigger threshold	float32	1de3	7651	Same as VirtualChannel.4.Main.PV
VirtualChannel.4.Alarm2.Type	As VirtualChannel1.Alarm1.Type	uint8	1de0	7648	Not applicable
VirtualChannel.4.Main.Descriptor	Virtual Channel descriptor	string_t	4b51	19281	Not applicable
VirtualChannel.4.Main.Disable	1 = Virtual channel disabled	bool	1da3	7587	Not applicable
VirtualChannel.4.Main.HighCutOff	The highest input value that will be totalised/counted	float32	1d85	7557	Set by VirtualChannel.4.Main.Resolution
VirtualChannel.4.Main.Input1	Input 1 value	float32	1d87	7559	Set by VirtualChannel.4.Main.Resolution
VirtualChannel.4.Main.Input2	Input 2 value	float32	1d88	7560	Set by VirtualChannel.4.Main.Resolution
VirtualChannel.4.Main.LowCutOff	The lowest input value that will be totalised/counted	float32	1d84	7556	Set by VirtualChannel.4.Main.Resolution
VirtualChannel.4.Main.ModbusInput	Modbus input value	float32	1d86	7558	Set by VirtualChannel.4.Main.Resolution
VirtualChannel.4.Main.Operation	As VirtualChannel1.Main.Operation	uint8	1d81	7553	Not applicable
VirtualChannel.4.Main.Period	Averaging period	int32	1d8a	7562	Not applicable
VirtualChannel.4.Main.Preset	Initiate preset. 0 = No; 1 = Yes	bool	1d8c	7564	Not applicable
VirtualChannel.4.Main.PresetValue	The Preset value	float32	1d8d	7565	Set by VirtualChannel.4.Main.Resolution
VirtualChannel.4.Main.PV	The virtual channel output value	float32	012c	300	Set by VirtualChannel.4.Main.Resolution
VirtualChannel.4.Main.Reset	Initiate reset. 0 = No; 1 = Yes	bool	1d8b	7563	Not applicable
VirtualChannel.4.Main.Resolution	Number of decimal places (0 to 6)	uint8	1d82	7554	Not applicable
VirtualChannel.4.Main.Rollover	A pulse signal to indicate PV (output) has just rolled over	bool	1d91	7569	Not applicable
VirtualChannel.4.Main.RolloverValue	Rollover value	float32	1d92	7570	Set by VirtualChannel.4.Main.Resolution
VirtualChannel.4.Main.Status	As VirtualChannel1.Main.Status	uint8	012d	301	Not applicable
VirtualChannel.4.Main.TimeRemaining	Time remaining before the calculation is made	time_t	1d89	7561	Set by Network.Modbus.TimeFormat
VirtualChannel.4.Main.Trigger	Increment/decrement counter. 0 = No; 1 = Yes	bool	1d8e	7566	Not applicable
VirtualChannel.4.Main.Type	As VirtualChannel1.Main.Type	uint8	1d80	7552	Not applicable
VirtualChannel.4.Main.Units	Units descriptor	string_t	4b66	19302	Not applicable
VirtualChannel.4.Main.UnitsScaler	Units scaler for totalisers	float32	1d83	7555	1dp
VirtualChannel.4.Trend.Colour	As VirtualChannel1.Trend.Colour	uint8	1da0	7584	Not applicable
VirtualChannel.4.Trend.SpanHigh	Specifies the highest PV (output value) to be displayed	float32	1da2	7586	Same as VirtualChannel.4.Main.PV
VirtualChannel.4.Trend.SpanLow	Specifies the lowest PV (output value) to be displayed	float32	1da1	7585	Same as VirtualChannel.4.Main.PV
VirtualChannel.5.Alarm1.Acknowledge	1 = acknowledge alarm	bool	01c8	456	Not applicable
VirtualChannel.5.Alarm1.Acknowledgement	1 = alarm acknowledged	bool	1e50	7760	Not applicable
VirtualChannel.5.Alarm1.Active	1 = alarm source active, or safe but not ack'd	bool	1e4b	7755	Not applicable
VirtualChannel.5.Alarm1.Amount	Rate-of-change alarm 'Amount'	float32	1e48	7752	Same as VirtualChannel.5.Main.PV
VirtualChannel.5.Alarm1.AverageTime	Rate-of-change alarm 'Average time'	time_t	1e4a	7754	Set by Network.Modbus.TimeFormat
VirtualChannel.5.Alarm1.Block	0 = Blocking alarms off; 1 = Blocking alarms on	uint8	1e42	7746	Not applicable
VirtualChannel.5.Alarm1.ChangeTime	Rate-of-change alarm 'Change Time'	uint8	1e49	7753	Not applicable
VirtualChannel.5.Alarm1.Deviation	Deviation alarm 'Deviation Value'	float32	1e47	7751	Same as VirtualChannel.5.Main.PV
VirtualChannel.5.Alarm1.Dwell	Alarm dwell time	time_t	1e45	7749	Set by Network.Modbus.TimeFormat
VirtualChannel.5.Alarm1.Hysteresis	Alarm hysteresis value	float32	1e44	7748	Same as VirtualChannel.5.Main.PV
VirtualChannel.5.Alarm1.Inactive	1 = alarm source safe and ack'd (if necessary)	bool	1e4e	7758	Not applicable

Parameter path	Description	Type	Hex	Dec	Resolution
VirtualChannel.5.Alarm1.Latch	As VirtualChannel1.Alarm1.Latch	uint8	1e41	7745	Not applicable
VirtualChannel.5.Alarm1.NotAcknowledged	1 = alarm has not been acknowledged	bool	1e4f	7759	Not applicable
VirtualChannel.5.Alarm1.Reference	Deviation alarm 'Reference' value	float32	1e46	7750	Same as VirtualChannel.5.Main.PV
VirtualChannel.5.Alarm1.Status	As VirtualChannel1.Alarm1.Status	uint8	0132	306	Not applicable
VirtualChannel.5.Alarm1.Threshold	Alarm trigger threshold	float32	1e43	7747	Same as VirtualChannel.5.Main.PV
VirtualChannel.5.Alarm1.Type	As VirtualChannel1.Alarm1.Type	uint8	1e40	7744	Not applicable
VirtualChannel.5.Alarm2.Acknowledge	1 = acknowledge alarm	bool	01c9	457	Not applicable
VirtualChannel.5.Alarm2.Acknowledgement	1 = alarm acknowledged	bool	1e70	7792	Not applicable
VirtualChannel.5.Alarm2.Active	1 = alarm source active, or safe but not ack'd	bool	1e6b	7787	Not applicable
VirtualChannel.5.Alarm2.Amount	Rate-of-change alarm 'Amount'	float32	1e68	7784	Same as VirtualChannel.5.Main.PV
VirtualChannel.5.Alarm2.AverageTime	Rate-of-change alarm 'Average time'	time_t	1e6a	7786	Set by Network.Modbus.TimeFormat
VirtualChannel.5.Alarm2.Block	0 = Blocking alarms off; 1 = Blocking alarms on	uint8	1e62	7778	Not applicable
VirtualChannel.5.Alarm2.ChangeTime	Rate-of-change alarm 'Change Time'	uint8	1e69	7785	Not applicable
VirtualChannel.5.Alarm2.Deviation	Deviation alarm 'Deviation Value'	float32	1e67	7783	Same as VirtualChannel.5.Main.PV
VirtualChannel.5.Alarm2.Dwell	Alarm dwell time	time_t	1e65	7781	Set by Network.Modbus.TimeFormat
VirtualChannel.5.Alarm2.Hysteresis	Alarm hysteresis value	float32	1e64	7780	Same as VirtualChannel.5.Main.PV
VirtualChannel.5.Alarm2.Inactive	1 = alarm source safe and ack'd (if necessary)	bool	1e6e	7790	Not applicable
VirtualChannel.5.Alarm2.Inhibit	1 = alarm inhibited	bool	1e71	7793	Not applicable
VirtualChannel.5.Alarm2.Latch	As VirtualChannel1.Alarm1.Latch	uint8	1e61	7777	Not applicable
VirtualChannel.5.Alarm2.NotAcknowledged	1 = alarm has not been acknowledged	bool	1e6f	7791	Not applicable
VirtualChannel.5.Alarm2.Reference	Deviation alarm 'Reference' value	float32	1e66	7782	Same as VirtualChannel.5.Main.PV
VirtualChannel.5.Alarm2.Status	As VirtualChannel1.Alarm1.Status	uint8	0133	307	Not applicable
VirtualChannel.5.Alarm2.Threshold	Alarm trigger threshold	float32	1e63	7779	Same as VirtualChannel.5.Main.PV
VirtualChannel.5.Alarm2.Type	As VirtualChannel1.Alarm1.Type	uint8	1e60	7776	Not applicable
VirtualChannel.5.Main.Descriptor	Virtual Channel descriptor	string_t	4b6c	19308	Not applicable
VirtualChannel.5.Main.Disable	1 = Virtual channel disabled	bool	1e23	7715	Not applicable
VirtualChannel.5.Main.HighCutOff	The highest input value that will be totalised/counted	float32	1e05	7685	Set by VirtualChannel.5.Main.Resolution
VirtualChannel.5.Main.Input1	Input 1 value	float32	1e07	7687	Set by VirtualChannel.5.Main.Resolution
VirtualChannel.5.Main.Input2	Input 2 value	float32	1e08	7688	Set by VirtualChannel.5.Main.Resolution
VirtualChannel.5.Main.LowCutOff	The lowest input value that will be totalised/counted	float32	1e04	7684	Set by VirtualChannel.5.Main.Resolution
VirtualChannel.5.Main.ModbusInput	Modbus input value	float32	1e06	7686	Set by VirtualChannel.5.Main.Resolution
VirtualChannel.5.Main.Operation	As VirtualChannel1.Main.Operation	uint8	1e01	7681	Not applicable
VirtualChannel.5.Main.Period	The time period over which the calculation is made	int32	1e0a	7690	Not applicable
VirtualChannel.5.Main.Preset	Initiate preset. 0 = No; 1 = Yes	bool	1e0c	7692	Not applicable
VirtualChannel.5.Main.PresetValue	The Preset value	float32	1e0d	7693	Set by VirtualChannel.5.Main.Resolution
VirtualChannel.5.Main.PV	The virtual channel output value	float32	0130	304	Set by VirtualChannel.5.Main.Resolution
VirtualChannel.5.Main.Reset	Initiate reset. 0 = No; 1 = Yes	bool	1e0b	7691	Not applicable
VirtualChannel.5.Main.Resolution	Number of decimal places (0 to 6)	uint8	1e02	7682	Not applicable
VirtualChannel.5.Main.Rollover	A pulse signal to indicate PV (output) has just rolled over	bool	1e11	7697	Not applicable
VirtualChannel.5.Main.RolloverValue	Rollover value	float32	1e12	7698	Set by VirtualChannel.5.Main.Resolution
VirtualChannel.5.Main.Status	As VirtualChannel1.Main.Status	uint8	0131	305	Not applicable
VirtualChannel.5.Main.TimeRemaining	Time remaining before the calculation is made	time_t	1e09	7689	Set by Network.Modbus.TimeFormat
VirtualChannel.5.Main.Trigger	Increment/decrement counter. 0 = No; 1 = Yes	bool	1e0e	7694	Not applicable
VirtualChannel.5.Main.Type	As VirtualChannel1.Main.Type	uint8	1e00	7680	Not applicable
VirtualChannel.5.Main.Units	Units descriptor	string_t	4b81	19329	Not applicable
VirtualChannel.5.Main.UnitsScaler	Units scaler for totalisers	float32	1e03	7683	1dp
VirtualChannel.5.Trend.Colour	As VirtualChannel1.Trend.Colour	uint8	1e20	7712	Not applicable
VirtualChannel.5.Trend.SpanHigh	Specifies the highest PV (output value) to be displayed	float32	1e22	7714	Same as VirtualChannel.5.Main.PV
VirtualChannel.5.Trend.SpanLow	Specifies the lowest PV (output value) to be displayed	float32	1e21	7713	Same as VirtualChannel.5.Main.PV
VirtualChannel.6.Alarm1.Acknowledge	1 = acknowledge alarm	bool	01ca	458	Not applicable
VirtualChannel.6.Alarm1.Acknowledgement	1 = alarm acknowledged	bool	1ed0	7888	Not applicable
VirtualChannel.6.Alarm1.Active	1 = alarm source active, or safe but not ack'd	bool	1ecb	7883	Not applicable
VirtualChannel.6.Alarm1.Amount	Rate-of-change alarm 'Amount'	float32	1ec8	7880	Same as VirtualChannel.6.Main.PV
VirtualChannel.6.Alarm1.AverageTime	Rate-of-change alarm 'Average time'	time_t	1eca	7882	Set by Network.Modbus.TimeFormat
VirtualChannel.6.Alarm1.Block	0 = Blocking alarms off; 1 = Blocking alarms on	uint8	1ec2	7874	Not applicable
VirtualChannel.6.Alarm1.ChangeTime	Rate-of-change alarm 'Change Time'	uint8	1ec9	7881	Not applicable
VirtualChannel.6.Alarm1.Deviation	Deviation alarm 'Deviation Value'	float32	1ec7	7879	Same as VirtualChannel.6.Main.PV
VirtualChannel.6.Alarm1.Dwell	Alarm dwell time	time_t	1ec5	7877	Set by Network.Modbus.TimeFormat
VirtualChannel.6.Alarm1.Hysteresis	Alarm hysteresis value	float32	1ec4	7876	Same as VirtualChannel.6.Main.PV
VirtualChannel.6.Alarm1.Inactive	1 = alarm source safe and ack'd (if necessary)	bool	1ec6	7878	Not applicable

Parameter path	Description	Type	Hex	Dec	Resolution
VirtualChannel.6.Alarm1.Latch	As VirtualChannel1.Alarm1.Latch	uint8	1ec1	7873	Not applicable
VirtualChannel.6.Alarm1.NotAcknowledged	1 = alarm has not been acknowledged	bool	1ecf	7887	Not applicable
VirtualChannel.6.Alarm1.Reference	Deviation alarm 'Reference' value	float32	1ec6	7878	Same as VirtualChannel.6.Main.PV
VirtualChannel.6.Alarm1.Status	As VirtualChannel1.Alarm1.Status	uint8	0136	310	Not applicable
VirtualChannel.6.Alarm1.Threshold	Alarm trigger threshold	float32	1ec3	7875	Same as VirtualChannel.6.Main.PV
VirtualChannel.6.Alarm1.Type	As VirtualChannel1.Alarm1.Type	uint8	1ec0	7872	Not applicable
VirtualChannel.6.Alarm2.Acknowledge	1 = acknowledge alarm	bool	01cb	459	Not applicable
VirtualChannel.6.Alarm2.Acknowledgement	1 = alarm acknowledged	bool	1ef0	7920	Not applicable
VirtualChannel.6.Alarm2.Active	1 = alarm source active, or safe but not ack'd	bool	1eeb	7915	Not applicable
VirtualChannel.6.Alarm2.Amount	Rate-of-change alarm 'Amount'	float32	1ee8	7912	Same as VirtualChannel.6.Main.PV
VirtualChannel.6.Alarm2.AverageTime	Rate-of-change alarm 'Average time'	time_t	1eea	7914	Set by Network.Modbus.TimeFormat
VirtualChannel.6.Alarm2.Block	0 = Blocking alarms off; 1 = Blocking alarms on	uint8	1ee2	7906	Not applicable
VirtualChannel.6.Alarm2.ChangeTime	Rate-of-change alarm 'Change Time'	uint8	1ee9	7913	Not applicable
VirtualChannel.6.Alarm2.Deviation	Deviation alarm 'Deviation Value'	float32	1ee7	7911	Same as VirtualChannel.6.Main.PV
VirtualChannel.6.Alarm2.Dwell	Alarm dwell time	time_t	1ee5	7909	Set by Network.Modbus.TimeFormat
VirtualChannel.6.Alarm2.Hysteresis	Alarm hysteresis value	float32	1ee4	7908	Same as VirtualChannel.6.Main.PV
VirtualChannel.6.Alarm2.Inactive	1 = alarm source safe and ack'd (if necessary)	bool	1eee	7918	Not applicable
VirtualChannel.6.Alarm2.Inhibit	1 = alarm inhibited	bool	1ef1	7921	Not applicable
VirtualChannel.6.Alarm2.Latch	As VirtualChannel1.Alarm1.Latch	uint8	1ee1	7905	Not applicable
VirtualChannel.6.Alarm2.NotAcknowledged	1 = alarm has not been acknowledged	bool	1eef	7919	Not applicable
VirtualChannel.6.Alarm2.Reference	Deviation alarm 'Reference' value	float32	1ee6	7910	Same as VirtualChannel.6.Main.PV
VirtualChannel.6.Alarm2.Status	As VirtualChannel1.Alarm1.Status	uint8	0137	311	Not applicable
VirtualChannel.6.Alarm2.Threshold	Alarm trigger threshold	float32	1ee3	7907	Same as VirtualChannel.6.Main.PV
VirtualChannel.6.Alarm2.Type	As VirtualChannel1.Alarm1.Type	uint8	1ee0	7904	Not applicable
VirtualChannel.6.Main.Descriptor	Virtual Channel descriptor	string_t	4b87	19335	Not applicable
VirtualChannel.6.Main.Disable	1 = Virtual channel disabled	bool	1ea3	7843	Not applicable
VirtualChannel.6.Main.HighCutOff	The highest input value that will be totalised/counted	float32	1e85	7813	Set by VirtualChannel.6.Main.Resolution
VirtualChannel.6.Main.Input1	Input 1 value	float32	1e87	7815	Set by VirtualChannel.6.Main.Resolution
VirtualChannel.6.Main.Input2	Input 2 value	float32	1e88	7816	Set by VirtualChannel.6.Main.Resolution
VirtualChannel.6.Main.LowCutOff	The lowest input value that will be totalised/counted	float32	1e84	7812	Set by VirtualChannel.6.Main.Resolution
VirtualChannel.6.Main.ModbusInput	Modbus input value	float32	1e86	7814	Set by VirtualChannel.6.Main.Resolution
VirtualChannel.6.Main.Operation	As VirtualChannel1.Main.Operation	uint8	1e81	7809	Not applicable
VirtualChannel.6.Main.Period	The time period over which the calculation is made	int32	1e8a	7818	Not applicable
VirtualChannel.6.Main.Preset	Initiate preset. 0 = No; 1 = Yes	bool	1e8c	7820	Not applicable
VirtualChannel.6.Main.PresetValue	The Preset value	float32	1e8d	7821	Set by VirtualChannel.6.Main.Resolution
VirtualChannel.6.Main.PV	The virtual channel output value	float32	0134	308	Set by VirtualChannel.6.Main.Resolution
VirtualChannel.6.Main.Reset	Initiate reset. 0 = No; 1 = Yes	bool	1e8b	7819	Not applicable
VirtualChannel.6.Main.Resolution	Number of decimal places (0 to 6)	uint8	1e82	7810	Not applicable
VirtualChannel.6.Main.Rollover	A pulse signal to indicate PV (output) has just rolled over	bool	1e91	7825	Not applicable
VirtualChannel.6.Main.RolloverValue	Rollover value	float32	1e92	7826	Set by VirtualChannel.6.Main.Resolution
VirtualChannel.6.Main.Status	As VirtualChannel1.Main.Status	uint8	0135	309	Not applicable
VirtualChannel.6.Main.TimeRemaining	Time remaining before the calculation is made	time_t	1e89	7817	Set by Network.Modbus.TimeFormat
VirtualChannel.6.Main.Trigger	Increment/decrement counter. 0 = No; 1 = Yes	bool	1e8e	7822	Not applicable
VirtualChannel.6.Main.Type	As VirtualChannel1.Main.Type	uint8	1e80	7808	Not applicable
VirtualChannel.6.Main.Units	Units descriptor	string_t	4b9c	19356	Not applicable
VirtualChannel.6.Main.UnitsScaler	Units scaler for totalisers	float32	1e83	7811	1dp
VirtualChannel.6.Trend.Colour	As VirtualChannel1.Trend.Colour	uint8	1ea0	7840	Not applicable
VirtualChannel.6.Trend.SpanHigh	Specifies the highest PV (output value) to be displayed	float32	1ea2	7842	Same as VirtualChannel.6.Main.PV
VirtualChannel.6.Trend.SpanLow	Specifies the lowest PV (output value) to be displayed	float32	1ea1	7841	Same as VirtualChannel.6.Main.PV
VirtualChannel.7.Alarm1.Acknowledge	1 = acknowledge alarm	bool	01cc	460	Not applicable
VirtualChannel.7.Alarm1.Acknowledgement	1 = alarm acknowledged	bool	1f50	8016	Not applicable
VirtualChannel.7.Alarm1.Active	1 = alarm source active, or safe but not ack'd	bool	1f4b	8011	Not applicable
VirtualChannel.7.Alarm1.Amount	Rate-of-change alarm 'Amount'	float32	1f48	8008	Same as VirtualChannel.7.Main.PV
VirtualChannel.7.Alarm1.AverageTime	Rate-of-change alarm 'Average time'	time_t	1f4a	8010	Set by Network.Modbus.TimeFormat
VirtualChannel.7.Alarm1.Block	0 = Blocking alarms off; 1 = Blocking alarms on	uint8	1f42	8002	Not applicable
VirtualChannel.7.Alarm1.ChangeTime	Rate-of-change alarm 'Change Time'	uint8	1f49	8009	Not applicable
VirtualChannel.7.Alarm1.Deviation	Deviation alarm 'Deviation Value'	float32	1f47	8007	Same as VirtualChannel.7.Main.PV
VirtualChannel.7.Alarm1.Dwell	Alarm dwell time	time_t	1f45	8005	Set by Network.Modbus.TimeFormat
VirtualChannel.7.Alarm1.Hysteresis	Alarm hysteresis value	float32	1f44	8004	Same as VirtualChannel.7.Main.PV
VirtualChannel.7.Alarm1.Inactive	1 = alarm source safe and ack'd (if necessary)	bool	1f4e	8014	Not applicable

Parameter path	Description	Type	Hex	Dec	Resolution
VirtualChannel.7.Alarm1.Latch	As VirtualChannel1.Alarm1.Latch	uint8	1f41	8001	Not applicable
VirtualChannel.7.Alarm1.NotAcknowledged	1 = alarm has not been acknowledged	bool	1f4f	8015	Not applicable
VirtualChannel.7.Alarm1.Reference	Deviation alarm 'Reference' value	float32	1f46	8006	Same as VirtualChannel.7.Main.PV
VirtualChannel.7.Alarm1.Status	As VirtualChannel1.Alarm1.Status	uint8	013a	314	Not applicable
VirtualChannel.7.Alarm1.Threshold	Alarm trigger threshold	float32	1f43	8003	Same as VirtualChannel.7.Main.PV
VirtualChannel.7.Alarm1.Type	As VirtualChannel1.Alarm1.Type	uint8	1f40	8000	Not applicable
VirtualChannel.7.Alarm2.Acknowledge	1 = acknowledge alarm	bool	01cd	461	Not applicable
VirtualChannel.7.Alarm2.Acknowledgement	1 = alarm acknowledged	bool	1f70	8048	Not applicable
VirtualChannel.7.Alarm2.Active	1 = alarm source active, or safe but not ack'd	bool	1f6b	8043	Not applicable
VirtualChannel.7.Alarm2.Amount	Rate-of-change alarm 'Amount'	float32	1f68	8040	Same as VirtualChannel.7.Main.PV
VirtualChannel.7.Alarm2.AverageTime	Rate-of-change alarm 'Average time'	time_t	1f6a	8042	Set by Network.Modbus.TimeFormat
VirtualChannel.7.Alarm2.Block	0 = Blocking alarms off; 1 = Blocking alarms on	uint8	1f62	8034	Not applicable
VirtualChannel.7.Alarm2.ChangeTime	Rate-of-change alarm 'Change Time'	uint8	1f69	8041	Not applicable
VirtualChannel.7.Alarm2.Deviation	Deviation alarm 'Deviation Value'	float32	1f67	8039	Same as VirtualChannel.7.Main.PV
VirtualChannel.7.Alarm2.Dwell	Alarm dwell time	time_t	1f65	8037	Set by Network.Modbus.TimeFormat
VirtualChannel.7.Alarm2.Hysteresis	Alarm hysteresis value	float32	1f64	8036	Same as VirtualChannel.7.Main.PV
VirtualChannel.7.Alarm2.Inactive	1 = alarm source safe and ack'd (if necessary)	bool	1f6e	8046	Not applicable
VirtualChannel.7.Alarm2.Inhibit	1 = alarm inhibited	bool	1f71	8049	Not applicable
VirtualChannel.7.Alarm2.Latch	As VirtualChannel1.Alarm1.Latch	uint8	1f61	8033	Not applicable
VirtualChannel.7.Alarm2.NotAcknowledged	1 = alarm has not been acknowledged	bool	1f6f	8047	Not applicable
VirtualChannel.7.Alarm2.Reference	Deviation alarm 'Reference' value	float32	1f66	8038	Same as VirtualChannel.7.Main.PV
VirtualChannel.7.Alarm2.Status	As VirtualChannel1.Alarm1.Status	float32	1f63	8035	Same as VirtualChannel.7.Main.PV
VirtualChannel.7.Alarm2.Type	As VirtualChannel1.Alarm1.Type	uint8	1f60	8032	Not applicable
VirtualChannel.7.Main.Descriptor	Virtual Channel descriptor	string_t	4ba2	19362	Not applicable
VirtualChannel.7.Main.Disable	1 = Virtual channel disabled	bool	1f23	7971	Not applicable
VirtualChannel.7.Main.HighCutOff	The highest input value that will be totalised/counted	float32	1f05	7941	Set by VirtualChannel.7.Main.Resolution
VirtualChannel.7.Main.Input1	Input 1 value	float32	1f07	7943	Set by VirtualChannel.7.Main.Resolution
VirtualChannel.7.Main.Input2	Input 2 value	float32	1f08	7944	Set by VirtualChannel.7.Main.Resolution
VirtualChannel.7.Main.LowCutOff	The lowest input value that will be totalised/counted	float32	1f04	7940	Set by VirtualChannel.7.Main.Resolution
VirtualChannel.7.Main.ModbusInput	Modbus input value	float32	1f06	7942	Set by VirtualChannel.7.Main.Resolution
VirtualChannel.7.Main.Operation	As VirtualChannel1.Main.Operation	uint8	1f01	7937	Not applicable
VirtualChannel.7.Main.Period	Averaging period	int32	1f0a	7946	Not applicable
VirtualChannel.7.Main.Preset	Initiate preset. 0 = No; 1 = Yes	bool	1f0c	7948	Not applicable
VirtualChannel.7.Main.PresetValue	The Preset value	float32	1f0d	7949	Set by VirtualChannel.7.Main.Resolution
VirtualChannel.7.Main.PV	The virtual channel output value	float32	0138	312	Set by VirtualChannel.7.Main.Resolution
VirtualChannel.7.Main.Reset	Initiate reset. 0 = No; 1 = Yes	bool	1f0b	7947	Not applicable
VirtualChannel.7.Main.Resolution	Number of decimal places (0 to 6)	uint8	1f02	7938	Not applicable
VirtualChannel.7.Main.Rollover	A pulse signal to indicate PV (output) has just rolled over	bool	1f11	7953	Not applicable
VirtualChannel.7.Main.RolloverValue	Rollover value	float32	1f12	7954	Set by VirtualChannel.7.Main.Resolution
VirtualChannel.7.Main.Status	As VirtualChannel1.Main.Status	uint8	0139	313	Not applicable
VirtualChannel.7.Main.TimeRemaining	Time remaining before calculation is made	time_t	1f09	7945	Set by Network.Modbus.TimeFormat
VirtualChannel.7.Main.Trigger	Increment/decrement counter. 0 = No; 1 = Yes	bool	1f0e	7950	Not applicable
VirtualChannel.7.Main.Type	As VirtualChannel1.Main.Type	uint8	1f00	7936	Not applicable
VirtualChannel.7.Main.Units	Units descriptor	string_t	4bb7	19383	Not applicable
VirtualChannel.7.Main.UnitsScaler	Units scaler for totalisers	float32	1f03	7939	1dp
VirtualChannel.7.Trend.Colour	As VirtualChannel1.Trend.Colour	uint8	1f20	7968	Not applicable
VirtualChannel.7.Trend.SpanHigh	Specifies the highest PV (output value) to be displayed	float32	1f22	7970	Same as VirtualChannel.7.Main.PV
VirtualChannel.7.Trend.SpanLow	Specifies the lowest PV (output value) to be displayed	float32	1f21	7969	Same as VirtualChannel.7.Main.PV
VirtualChannel.8.Alarm1.Acknowledge	1 = acknowledge alarm	bool	01ce	462	Not applicable
VirtualChannel.8.Alarm1.Acknowledgement	1 = alarm acknowledged	bool	1fd0	8144	Not applicable
VirtualChannel.8.Alarm1.Active	1 = alarm source active, or safe but not ack'd	bool	1fcb	8139	Not applicable
VirtualChannel.8.Alarm1.Amount	Rate-of-change alarm 'Amount'	float32	1fc8	8136	Same as VirtualChannel.8.Main.PV
VirtualChannel.8.Alarm1.AverageTime	Rate-of-change alarm 'Average time'	time_t	1fca	8138	Set by Network.Modbus.TimeFormat
VirtualChannel.8.Alarm1.Block	0 = Blocking alarms off; 1 = Blocking alarms on	uint8	1fc2	8130	Not applicable
VirtualChannel.8.Alarm1.ChangeTime	Rate-of-change alarm 'Change Time'	uint8	1fc9	8137	Not applicable
VirtualChannel.8.Alarm1.Deviation	Deviation alarm 'Deviation Value'	float32	1fc7	8135	Same as VirtualChannel.8.Main.PV
VirtualChannel.8.Alarm1.Dwell	Alarm dwell time	time_t	1fc5	8133	Set by Network.Modbus.TimeFormat
VirtualChannel.8.Alarm1.Hysteresis	Alarm hysteresis value	float32	1fc4	8132	Same as VirtualChannel.8.Main.PV
VirtualChannel.8.Alarm1.Inactive	1 = alarm source safe and ack'd (if necessary)	bool	1fce	8142	Not applicable
VirtualChannel.8.Alarm1.Inhibit	1 = alarm inhibited	bool	1fd1	8145	Not applicable

Parameter path	Description	Type	Hex	Dec	Resolution
VirtualChannel.8.Alarm1.NotAcknowledged	1 = alarm has not been acknowledged	bool	1fcf	8143	Not applicable
VirtualChannel.8.Alarm1.Reference	Deviation alarm 'Reference' value	float32	1fc6	8134	Same as VirtualChannel.8.Main.PV
VirtualChannel.8.Alarm1.Status	As VirtualChannel1.Alarm1.Status	uint8	013e	318	Not applicable
VirtualChannel.8.Alarm1.Threshold	Alarm trigger threshold	float32	1fc3	8131	Same as VirtualChannel.8.Main.PV
VirtualChannel.8.Alarm1.Type	As VirtualChannel1.Alarm1.Type	uint8	1fc0	8128	Not applicable
VirtualChannel.8.Alarm2.Acknowledge	1 = acknowledge alarm	bool	01cf	463	Not applicable
VirtualChannel.8.Alarm2.Acknowledgement	1 = alarm acknowledged	bool	1ff0	8176	Not applicable
VirtualChannel.8.Alarm2.Active	1 = alarm source active, or safe but not ack'd	bool	1feb	8171	Not applicable
VirtualChannel.8.Alarm2.Amount	Rate-of-change alarm 'Amount'	float32	1fe8	8168	Same as VirtualChannel.8.Main.PV
VirtualChannel.8.Alarm2.AverageTime	Rate-of-change alarm 'Average time'	time_t	1fea	8170	Set by Network.Modbus.TimeFormat
VirtualChannel.8.Alarm2.Block	0 = Blocking alarms off; 1 = Blocking alarms on	uint8	1fe2	8162	Not applicable
VirtualChannel.8.Alarm2.ChangeTime	Rate-of-change alarm 'Change Time'	uint8	1fe9	8169	Not applicable
VirtualChannel.8.Alarm2.Deviation	Deviation alarm 'Deviation Value'	float32	1fe7	8167	Same as VirtualChannel.8.Main.PV
VirtualChannel.8.Alarm2.Dwell	Alarm dwell time	time_t	1fe5	8165	Set by Network.Modbus.TimeFormat
VirtualChannel.8.Alarm2.Hysteresis	Alarm hysteresis value	float32	1fe4	8164	Same as VirtualChannel.8.Main.PV
VirtualChannel.8.Alarm2.Inactive	1 = alarm source safe and ack'd (if necessary)	bool	1fee	8174	Not applicable
VirtualChannel.8.Alarm2.Inhibit	1 = alarm inhibited	bool	1ff1	8177	Not applicable
VirtualChannel.8.Alarm2.Latch	As VirtualChannel1.Alarm1.Latch	uint8	1fe1	8161	Not applicable
VirtualChannel.8.Alarm2.NotAcknowledged	1 = alarm has not been acknowledged	bool	1fef	8175	Not applicable
VirtualChannel.8.Alarm2.Reference	Deviation alarm 'Reference' value	float32	1fe6	8166	Same as VirtualChannel.8.Main.PV
VirtualChannel.8.Alarm2.Status	As VirtualChannel1.Alarm1.Status	uint8	013f	319	Not applicable
VirtualChannel.8.Alarm2.Threshold	Alarm trigger threshold	float32	1fe3	8163	Same as VirtualChannel.8.Main.PV
VirtualChannel.8.Alarm2.Type	As VirtualChannel1.Alarm1.Type	uint8	1fe0	8160	Not applicable
VirtualChannel.8.Main.Descriptor	Virtual Channel descriptor	string_t	4bbd	19389	Not applicable
VirtualChannel.8.Main.Disable	1 = Virtual channel disabled	bool	1fa3	8099	Not applicable
VirtualChannel.8.Main.HighCutOff	The highest input value that will be totalised/counted	float32	1f85	8069	Set by VirtualChannel.8.Main.Resolution
VirtualChannel.8.Main.Input1	Input 1 value	float32	1f87	8071	Set by VirtualChannel.8.Main.Resolution
VirtualChannel.8.Main.Input2	Input 2 value	float32	1f88	8072	Set by VirtualChannel.8.Main.Resolution
VirtualChannel.8.Main.LowCutOff	The lowest input value that will be totalised/counted	float32	1f84	8068	Set by VirtualChannel.8.Main.Resolution
VirtualChannel.8.Main.ModbusInput	Modbus input value	float32	1f86	8070	Set by VirtualChannel.8.Main.Resolution
VirtualChannel.8.Main.Operation	As VirtualChannel1.Main.Operation	uint8	1f81	8065	Not applicable
VirtualChannel.8.Main.Period	The time period over which the calculation is made	int32	1f8a	8074	Not applicable
VirtualChannel.8.Main.Preset	Initiate preset. 0 = No; 1 = Yes	bool	1f8c	8076	Not applicable
VirtualChannel.8.Main.PresetValue	The Preset value	float32	1f8d	8077	Set by VirtualChannel.8.Main.Resolution
VirtualChannel.8.Main.PV	The virtual channel output value	float32	013c	316	Set by VirtualChannel.8.Main.Resolution
VirtualChannel.8.Main.Reset	Initiate reset. 0 = No; 1 = Yes	bool	1f8b	8075	Not applicable
VirtualChannel.8.Main.Resolution	Number of decimal places (0 to 6)	uint8	1f82	8066	Not applicable
VirtualChannel.8.Main.Rollover	A pulse signal to indicate PV (output) has just rolled over	bool	1f91	8081	Not applicable
VirtualChannel.8.Main.RolloverValue	Rollover value	float32	1f92	8082	Set by VirtualChannel.8.Main.Resolution
VirtualChannel.8.Main.Status	As VirtualChannel1.Main.Status	uint8	013d	317	Not applicable
VirtualChannel.8.Main.TimeRemaining	Time remaining before the calculation is made	time_t	1f89	8073	Set by Network.Modbus.TimeFormat
VirtualChannel.8.Main.Trigger	Increment/decrement counter. 0 = No; 1 = Yes	bool	1f8e	8078	Not applicable
VirtualChannel.8.Main.Type	As VirtualChannel1.Main.Type	uint8	1f80	8064	Not applicable
VirtualChannel.8.Main.Units	Units descriptor	string_t	4bd2	19410	Not applicable
VirtualChannel.8.Main.UnitsScaler	Units scaler for totalisers	float32	1f83	8067	1dp
VirtualChannel.8.Trend.Colour	As VirtualChannel1.Trend.Colour	uint8	1fa0	8096	Not applicable
VirtualChannel.8.Trend.SpanHigh	Specifies the highest PV (output value) to be displayed	float32	1fa2	8098	Same as VirtualChannel.8.Main.PV
VirtualChannel.8.Trend.SpanLow	Specifies the lowest PV (output value) to be displayed	float32	1fa1	8097	Same as VirtualChannel.8.Main.PV
VirtualChannel.9.Alarm1.Acknowledge	1 = acknowledge alarm	bool	01d0	464	Not applicable
VirtualChannel.9.Alarm1.Acknowledgement	1 = alarm acknowledged	bool	2050	8272	Not applicable
VirtualChannel.9.Alarm1.Active	1 = alarm source active, or safe but not ack'd	bool	204b	8267	Not applicable
VirtualChannel.9.Alarm1.Amount	Rate-of-change alarm 'Amount'	float32	2048	8264	Same as VirtualChannel.9.Main.PV
VirtualChannel.9.Alarm1.AverageTime	Rate-of-change alarm 'Average time'	time_t	204a	8266	Set by Network.Modbus.TimeFormat
VirtualChannel.9.Alarm1.Block	0 = Blocking alarms off; 1 = Blocking alarms on	uint8	2042	8258	Not applicable
VirtualChannel.9.Alarm1.ChangeTime	Rate-of-change alarm 'Change Time'	uint8	2049	8265	Not applicable
VirtualChannel.9.Alarm1.Deviation	Deviation alarm 'Deviation Value'	float32	2047	8263	Same as VirtualChannel.9.Main.PV
VirtualChannel.9.Alarm1.Dwell	Alarm dwell time	time_t	2045	8261	Set by Network.Modbus.TimeFormat
VirtualChannel.9.Alarm1.Hysteresis	Alarm hysteresis value	float32	2044	8260	Same as VirtualChannel.9.Main.PV
VirtualChannel.9.Alarm1.Inactive	1 = alarm source safe and ack'd (if necessary)	bool	204e	8270	Not applicable
VirtualChannel.9.Alarm1.Inhibit	1 = alarm inhibited	bool	2051	8273	Not applicable

Parameter path	Description	Type	Hex	Dec	Resolution
VirtualChannel.9.Alarm1.NotAcknowledged	1 = alarm has not been acknowledged	bool	204f	8271	Not applicable
VirtualChannel.9.Alarm1.Reference	Deviation alarm 'Reference' value	float32	2046	8262	Same as VirtualChannel.9.Main.PV
VirtualChannel.9.Alarm1.Status	As VirtualChannel1.Alarm1.Status	uint8	0142	322	Not applicable
VirtualChannel.9.Alarm1.Threshold	Alarm trigger threshold	float32	2043	8259	Same as VirtualChannel.9.Main.PV
VirtualChannel.9.Alarm1.Type	As VirtualChannel1.Alarm1.Type	uint8	2040	8256	Not applicable
VirtualChannel.9.Alarm2.Acknowledge	1 = acknowledge alarm	bool	01d1	465	Not applicable
VirtualChannel.9.Alarm2.Acknowledgement	1 = alarm acknowledged	bool	2070	8304	Not applicable
VirtualChannel.9.Alarm2.Active	1 = alarm source active, or safe but not ack'd	bool	206b	8299	Not applicable
VirtualChannel.9.Alarm2.Amount	Rate-of-change alarm 'Amount'	float32	2068	8296	Same as VirtualChannel.9.Main.PV
VirtualChannel.9.Alarm2.AverageTime	Rate-of-change alarm 'Average time'	time_t	206a	8298	Set by Network.Modbus.TimeFormat
VirtualChannel.9.Alarm2.Block	0 = Blocking alarms off; 1 = Blocking alarms on	uint8	2062	8290	Not applicable
VirtualChannel.9.Alarm2.ChangeTime	Rate-of-change alarm 'Change Time'	uint8	2069	8297	Not applicable
VirtualChannel.9.Alarm2.Deviation	Deviation alarm 'Deviation Value'	float32	2067	8295	Same as VirtualChannel.9.Main.PV
VirtualChannel.9.Alarm2.Dwell	Alarm dwell time	time_t	2065	8293	Set by Network.Modbus.TimeFormat
VirtualChannel.9.Alarm2.Hysteresis	Alarm hysteresis value	float32	2064	8292	Same as VirtualChannel.9.Main.PV
VirtualChannel.9.Alarm2.Inactive	1 = alarm source safe and ack'd (if necessary)	bool	206e	8302	Not applicable
VirtualChannel.9.Alarm2.Inhibit	Inhibit	bool	2071	8305	Not applicable
VirtualChannel.9.Alarm2.Latch	As VirtualChannel1.Alarm1.Latch	uint8	2061	8289	Not applicable
VirtualChannel.9.Alarm2.NotAcknowledged	1 = alarm has not been acknowledged	bool	206f	8303	Not applicable
VirtualChannel.9.Alarm2.Reference	Deviation alarm 'Reference' value	float32	2066	8294	Same as VirtualChannel.9.Main.PV
VirtualChannel.9.Alarm2.Status	As VirtualChannel1.Alarm1.Status	uint8	0143	323	Not applicable
VirtualChannel.9.Alarm2.Threshold	Alarm trigger threshold	float32	2063	8291	Same as VirtualChannel.9.Main.PV
VirtualChannel.9.Alarm2.Type	As VirtualChannel1.Alarm1.Type	uint8	2060	8288	Not applicable
VirtualChannel.9.Main.Descriptor	Virtual Channel descriptor	string_t	4bd8	19416	Not applicable
VirtualChannel.9.Main.Disable	1 = Virtual channel disabled	bool	2023	8227	Not applicable
VirtualChannel.9.Main.HighCutOff	The highest input value that will be totalised/counted	float32	2005	8197	Set by VirtualChannel.9.Main.Resolution
VirtualChannel.9.Main.Input1	Input 1 value	float32	2007	8199	Set by VirtualChannel.9.Main.Resolution
VirtualChannel.9.Main.Input2	Input 2 value	float32	2008	8200	Set by VirtualChannel.9.Main.Resolution
VirtualChannel.9.Main.LowCutOff	The lowest input value that will be totalised/counted	float32	2004	8196	Set by VirtualChannel.9.Main.Resolution
VirtualChannel.9.Main.ModbusInput	Modbus input value	float32	2006	8198	Set by VirtualChannel.9.Main.Resolution
VirtualChannel.9.Main.Operation	As VirtualChannel1.Main.Operation	uint8	2001	8193	Not applicable
VirtualChannel.9.Main.Period	The time period over which the calculation is made	int32	200a	8202	Not applicable
VirtualChannel.9.Main.Preset	Initiate preset. 0 = No; 1 = Yes	bool	200c	8204	Not applicable
VirtualChannel.9.Main.PresetValue	The Preset value	float32	200d	8205	Set by VirtualChannel.9.Main.Resolution
VirtualChannel.9.Main.PV	The virtual channel output value	float32	0140	320	Set by VirtualChannel.9.Main.Resolution
VirtualChannel.9.Main.Reset	Initiate reset. 0 = No; 1 = Yes	bool	200b	8203	Not applicable
VirtualChannel.9.Main.Resolution	Number of decimal places (0 to 6)	uint8	2002	8194	Not applicable
VirtualChannel.9.Main.Rollover	A pulse signal to indicate PV (output) has just rolled over	bool	2011	8209	Not applicable
VirtualChannel.9.Main.RolloverValue	Rollover value	float32	2012	8210	Set by VirtualChannel.9.Main.Resolution
VirtualChannel.9.Main.Status	As VirtualChannel1.Main.Status	uint8	0141	321	Not applicable
VirtualChannel.9.Main.TimeRemaining	Time remaining before the calculation is made	time_t	2009	8201	Set by Network.Modbus.TimeFormat
VirtualChannel.9.Main.Trigger	Increment/decrement counter. 0 = No; 1 = Yes	bool	200e	8206	Not applicable
VirtualChannel.9.Main.Type	As VirtualChannel1.Main.Type	uint8	2000	8192	Not applicable
VirtualChannel.9.Main.Units	Units descriptor	string_t	4bed	19437	Not applicable
VirtualChannel.9.Main.UnitsScaler	Units scaler for totalisers	float32	2003	8195	1dp
VirtualChannel.9.Trend.Colour	As VirtualChannel1.Trend.Colour	uint8	2020	8224	Not applicable
VirtualChannel.9.Trend.SpanHigh	Specifies the highest PV (output value) to be displayed	float32	2022	8226	Same as VirtualChannel.9.Main.PV
VirtualChannel.9.Trend.SpanLow	Specifies the lowest PV (output value) to be displayed	float32	2021	8225	Same as VirtualChannel.9.Main.PV
VirtualChannel.10.Alarm1.Acknowledge	1 = acknowledge alarm	bool	01d2	466	Not applicable
VirtualChannel.10.Alarm1.Acknowledgement	1 = alarm acknowledged	bool	20d0	8400	Not applicable
VirtualChannel.10.Alarm1.Active	1 = alarm source active, or safe but not ack'd	bool	20cb	8395	Not applicable
VirtualChannel.10.Alarm1.Amount	Rate-of-change alarm 'Amount'	float32	20c8	8392	Same as VirtualChannel.10.Main.PV
VirtualChannel.10.Alarm1.AverageTime	Rate-of-change alarm 'Average time'	time_t	20ca	8394	Set by Network.Modbus.TimeFormat
VirtualChannel.10.Alarm1.Block	0 = Blocking alarms off; 1 = Blocking alarms on	uint8	20c2	8386	Not applicable
VirtualChannel.10.Alarm1.ChangeTime	Rate-of-change alarm 'Change Time'	uint8	20c9	8393	Not applicable
VirtualChannel.10.Alarm1.Deviation	Deviation alarm 'Deviation Value'	float32	20c7	8391	Same as VirtualChannel.10.Main.PV
VirtualChannel.10.Alarm1.Dwell	Alarm dwell time	time_t	20c5	8389	Set by Network.Modbus.TimeFormat
VirtualChannel.10.Alarm1.Hysteresis	Alarm hysteresis value	float32	20c4	8388	Same as VirtualChannel.10.Main.PV
VirtualChannel.10.Alarm1.Inactive	1 = alarm source safe and ack'd (if necessary)	bool	20ce	8398	Not applicable
VirtualChannel.10.Alarm1.Inhibit	1 = alarm inhibited	bool	20d1	8401	Not applicable

Parameter path	Description	Type	Hex	Dec	Resolution
VirtualChannel.10.Alarm1.NotAcknowledged	1 = alarm has not been acknowledged	bool	20cf	8399	Not applicable
VirtualChannel.10.Alarm1.Reference	Deviation alarm 'Reference' value	float32	20c6	8390	Same as VirtualChannel.10.Main.PV
VirtualChannel.10.Alarm1.Status	As VirtualChannel1.Alarm1.Status	uint8	0146	326	Not applicable
VirtualChannel.10.Alarm1.Threshold	Alarm trigger threshold	float32	20c3	8387	Same as VirtualChannel.10.Main.PV
VirtualChannel.10.Alarm1.Type	As VirtualChannel1.Alarm1.Type	uint8	20c0	8384	Not applicable
VirtualChannel.10.Alarm2.Acknowledge	1 = acknowledge alarm	bool	01d3	467	Not applicable
VirtualChannel.10.Alarm2.Acknowledgement	1 = alarm acknowledged	bool	20f0	8432	Not applicable
VirtualChannel.10.Alarm2.Active	1 = alarm source active, or safe but not ack'd	bool	20eb	8427	Not applicable
VirtualChannel.10.Alarm2.Amount	Rate-of-change alarm 'Amount'	float32	20e8	8424	Same as VirtualChannel.10.Main.PV
VirtualChannel.10.Alarm2.AverageTime	Rate-of-change alarm 'Average time'	time_t	20ea	8426	Set by Network.Modbus.TimeFormat
VirtualChannel.10.Alarm2.Block	0 = Blocking alarms off; 1 = Blocking alarms on	uint8	20e2	8418	Not applicable
VirtualChannel.10.Alarm2.ChangeTime	Rate-of-change alarm 'Change Time'	uint8	20e9	8425	Not applicable
VirtualChannel.10.Alarm2.Deviation	Deviation alarm 'Deviation Value'	float32	20e7	8423	Same as VirtualChannel.10.Main.PV
VirtualChannel.10.Alarm2.Dwell	Alarm dwell time	time_t	20e5	8421	Set by Network.Modbus.TimeFormat
VirtualChannel.10.Alarm2.Hysteresis	Alarm hysteresis value	float32	20e4	8420	Same as VirtualChannel.10.Main.PV
VirtualChannel.10.Alarm2.Inactive	1 = alarm source safe and ack'd (if necessary)	bool	20ee	8430	Not applicable
VirtualChannel.10.Alarm2.Inhibit	1 = alarm inhibited	bool	20f1	8433	Not applicable
VirtualChannel.10.Alarm2.Latch	As VirtualChannel1.Alarm1.Latch	uint8	20e1	8417	Not applicable
VirtualChannel.10.Alarm2.NotAcknowledged	1 = alarm has not been acknowledged	bool	20ef	8431	Not applicable
VirtualChannel.10.Alarm2.Reference	Deviation alarm 'Reference' value	float32	20e6	8422	Same as VirtualChannel.10.Main.PV
VirtualChannel.10.Alarm2.Status	As VirtualChannel1.Alarm1.Status	uint8	0147	327	Not applicable
VirtualChannel.10.Alarm2.Threshold	Alarm trigger threshold	float32	20e3	8419	Same as VirtualChannel.10.Main.PV
VirtualChannel.10.Alarm2.Type	As VirtualChannel1.Alarm1.Type	uint8	20e0	8416	Not applicable
VirtualChannel.10.Main.Descriptor	Virtual Channel descriptor	string_t	4bf3	19443	Not applicable
VirtualChannel.10.Main.Disable	1 = Virtual channel disabled	bool	20a3	8355	Not applicable
VirtualChannel.10.Main.HighCutOff	The highest input value that will be totalised/counted	float32	2085	8325	Set by VirtualChannel.10.Main.Resolution
VirtualChannel.10.Main.Input1	Input 1 value	float32	2087	8327	Set by VirtualChannel.10.Main.Resolution
VirtualChannel.10.Main.Input2	Input 2 value	float32	2088	8328	Set by VirtualChannel.10.Main.Resolution
VirtualChannel.10.Main.LowCutOff	The lowest input value that will be totalised/counted	float32	2084	8324	Set by VirtualChannel.10.Main.Resolution
VirtualChannel.10.Main.ModbusInput	Modbus input value	float32	2086	8326	Set by VirtualChannel.10.Main.Resolution
VirtualChannel.10.Main.Operation	As VirtualChannel1.Main.Operation	uint8	2081	8321	Not applicable
VirtualChannel.10.Main.Period	Averaging period	int32	208a	8330	Not applicable
VirtualChannel.10.Main.Preset	Initiate preset. 0 = No; 1 = Yes	bool	208c	8332	Not applicable
VirtualChannel.10.Main.PresetValue	The Preset value	float32	208d	8333	Set by VirtualChannel.10.Main.Resolution
VirtualChannel.10.Main.PV	The virtual channel output value	float32	0144	324	Set by VirtualChannel.10.Main.Resolution
VirtualChannel.10.Main.Reset	Initiate reset. 0 = No; 1 = Yes	bool	208b	8331	Not applicable
VirtualChannel.10.Main.Resolution	Number of decimal places (0 to 6)	uint8	2082	8322	Not applicable
VirtualChannel.10.Main.Rollover	A pulse signal to indicate PV (output) has just rolled over	bool	2091	8337	Not applicable
VirtualChannel.10.Main.RolloverValue	Rollover value	float32	2092	8338	Set by VirtualChannel.10.Main.Resolution
VirtualChannel.10.Main.Status	As VirtualChannel1.Main.Status	uint8	0145	325	Not applicable
VirtualChannel.10.Main.TimeRemaining	Time remaining before the calculation is made	time_t	2089	8329	Set by Network.Modbus.TimeFormat
VirtualChannel.10.Main.Trigger	Increment/decrement counter. 0 = No; 1 = Yes	bool	208e	8334	Not applicable
VirtualChannel.10.Main.Type	As VirtualChannel1.Main.Type	uint8	2080	8320	Not applicable
VirtualChannel.10.Main.Units	Units descriptor	string_t	4c08	19464	Not applicable
VirtualChannel.10.Main.UnitsScaler	Units scaler for totalisers	float32	2083	8323	1dp
VirtualChannel.10.Trend.Colour	As VirtualChannel1.Trend.Colour	uint8	20a0	8352	Not applicable
VirtualChannel.10.Trend.SpanHigh	Specifies the highest PV (output value) to be displayed	float32	20a2	8354	Same as VirtualChannel.10.Main.PV
VirtualChannel.10.Trend.SpanLow	Specifies the lowest PV (output value) to be displayed	float32	20a1	8353	Same as VirtualChannel.10.Main.PV
VirtualChannel.11.Alarm1.Acknowledge	1 = acknowledge alarm	bool	01d4	468	Not applicable
VirtualChannel.11.Alarm1.Acknowledgement	1 = alarm acknowledged	bool	2150	8528	Not applicable
VirtualChannel.11.Alarm1.Active	1 = alarm source active, or safe but not ack'd	bool	214b	8523	Not applicable
VirtualChannel.11.Alarm1.Amount	Rate-of-change alarm 'Amount'	float32	2148	8520	Same as VirtualChannel.11.Main.PV
VirtualChannel.11.Alarm1.AverageTime	Rate-of-change alarm 'Average time'	time_t	214a	8522	Set by Network.Modbus.TimeFormat
VirtualChannel.11.Alarm1.Block	0 = Blocking alarms off; 1 = Blocking alarms on	uint8	2142	8514	Not applicable
VirtualChannel.11.Alarm1.ChangeTime	Rate-of-change alarm 'Change Time'	uint8	2149	8521	Not applicable
VirtualChannel.11.Alarm1.Deviation	Deviation alarm 'Deviation Value'	float32	2147	8519	Same as VirtualChannel.11.Main.PV
VirtualChannel.11.Alarm1.Dwell	Alarm dwell time	time_t	2145	8517	Set by Network.Modbus.TimeFormat
VirtualChannel.11.Alarm1.Hysteresis	Alarm hysteresis value	float32	2144	8516	Same as VirtualChannel.11.Main.PV
VirtualChannel.11.Alarm1.Inactive	1 = alarm source safe and ack'd (if necessary)	bool	214e	8526	Not applicable
VirtualChannel.11.Alarm1.Inhibit	1 = alarm inhibited	bool	2151	8529	Not applicable

Parameter path	Description	Type	Hex	Dec	Resolution
VirtualChannel.11.Alarm1.NotAcknowledged	1 = alarm has not been acknowledged	bool	214f	8527	Not applicable
VirtualChannel.11.Alarm1.Reference	Deviation alarm 'Reference' value	float32	2146	8518	Same as VirtualChannel.11.Main.PV
VirtualChannel.11.Alarm1.Status	As VirtualChannel1.Alarm1.Status	uint8	014a	330	Not applicable
VirtualChannel.11.Alarm1.Threshold	Alarm trigger threshold	float32	2143	8515	Same as VirtualChannel.11.Main.PV
VirtualChannel.11.Alarm1.Type	As VirtualChannel1.Alarm1.Type	uint8	2140	8512	Not applicable
VirtualChannel.11.Alarm2.Acknowledge	1 = acknowledge alarm	bool	01d5	469	Not applicable
VirtualChannel.11.Alarm2.Acknowledgement	1 = alarm acknowledged	bool	2170	8560	Not applicable
VirtualChannel.11.Alarm2.Active	1 = alarm source active, or safe but not ack'd	bool	216b	8555	Not applicable
VirtualChannel.11.Alarm2.Amount	Rate-of-change alarm 'Amount'	float32	2168	8552	Same as VirtualChannel.11.Main.PV
VirtualChannel.11.Alarm2.AverageTime	Rate-of-change alarm 'Average time'	time_t	216a	8554	Set by Network.Modbus.TimeFormat
VirtualChannel.11.Alarm2.Block	0 = Blocking alarms off; 1 = Blocking alarms on	uint8	2162	8546	Not applicable
VirtualChannel.11.Alarm2.ChangeTime	Rate-of-change alarm 'Change Time'	uint8	2169	8553	Not applicable
VirtualChannel.11.Alarm2.Deviation	Deviation alarm 'Deviation Value'	float32	2167	8551	Same as VirtualChannel.11.Main.PV
VirtualChannel.11.Alarm2.Dwell	Alarm dwell time	time_t	2165	8549	Set by Network.Modbus.TimeFormat
VirtualChannel.11.Alarm2.Hysteresis	Alarm hysteresis value	float32	2164	8548	Same as VirtualChannel.11.Main.PV
VirtualChannel.11.Alarm2.Inactive	1 = alarm source safe and ack'd (if necessary)	bool	216e	8558	Not applicable
VirtualChannel.11.Alarm2.Inhibit	1 = alarm inhibited	bool	2171	8561	Not applicable
VirtualChannel.11.Alarm2.Latch	As VirtualChannel1.Alarm1.Latch	uint8	2161	8545	Not applicable
VirtualChannel.11.Alarm2.NotAcknowledged	1 = alarm has not been acknowledged	bool	216f	8559	Not applicable
VirtualChannel.11.Alarm2.Reference	Deviation alarm 'Reference' value	float32	2166	8550	Same as VirtualChannel.11.Main.PV
VirtualChannel.11.Alarm2.Status	As VirtualChannel1.Alarm1.Status	uint8	014b	331	Not applicable
VirtualChannel.11.Alarm2.Threshold	Alarm trigger threshold	float32	2163	8547	Same as VirtualChannel.11.Main.PV
VirtualChannel.11.Alarm2.Type	As VirtualChannel1.Alarm1.Type	uint8	2160	8544	Not applicable
VirtualChannel.11.Main.Descriptor	Virtual Channel descriptor	string_t	4c0e	19470	Not applicable
VirtualChannel.11.Main.Disable	1 = Virtual channel disabled	bool	2123	8483	Not applicable
VirtualChannel.11.Main.HighCutOff	The highest input value that will be totalised/counted	float32	2105	8453	Set by VirtualChannel.11.Main.Resolution
VirtualChannel.11.Main.Input1	Input 1 value	float32	2107	8455	Set by VirtualChannel.11.Main.Resolution
VirtualChannel.11.Main.Input2	Input 2 value	float32	2108	8456	Set by VirtualChannel.11.Main.Resolution
VirtualChannel.11.Main.LowCutOff	The lowest input value that will be totalised/counted	float32	2104	8452	Set by VirtualChannel.11.Main.Resolution
VirtualChannel.11.Main.ModbusInput	Modbus input value	float32	2106	8454	Set by VirtualChannel.11.Main.Resolution
VirtualChannel.11.Main.Operation	As VirtualChannel1.Main.Operation	uint8	2101	8449	Not applicable
VirtualChannel.11.Main.Period	The time period over which the calculation is made	int32	210a	8458	Not applicable
VirtualChannel.11.Main.Preset	Initiate preset. 0 = No; 1 = Yes	bool	210c	8460	Not applicable
VirtualChannel.11.Main.PresetValue	The Preset value	float32	210d	8461	Set by VirtualChannel.11.Main.Resolution
VirtualChannel.11.Main.PV	The virtual channel output value	float32	0148	328	Set by VirtualChannel.11.Main.Resolution
VirtualChannel.11.Main.Reset	Initiate reset. 0 = No; 1 = Yes	bool	210b	8459	Not applicable
VirtualChannel.11.Main.Resolution	Number of decimal places (0 to 6)	uint8	2102	8450	Not applicable
VirtualChannel.11.Main.Rollover	A pulse signal to indicate PV (output) has just rolled over	bool	2111	8465	Not applicable
VirtualChannel.11.Main.RolloverValue	Rollover value	float32	2112	8466	Set by VirtualChannel.11.Main.Resolution
VirtualChannel.11.Main.Status	As VirtualChannel1.Main.Status	uint8	0149	329	Not applicable
VirtualChannel.11.Main.TimeRemaining	Time remaining before the calculation is made	time_t	2109	8457	Set by Network.Modbus.TimeFormat
VirtualChannel.11.Main.Trigger	Increment/decrement counter. 0 = No; 1 = Yes	bool	210e	8462	Not applicable
VirtualChannel.11.Main.Type	As VirtualChannel1.Main.Type	uint8	2100	8448	Not applicable
VirtualChannel.11.Main.Units	Units descriptor	string_t	4c23	19491	Not applicable
VirtualChannel.11.Main.UnitsScaler	Units scaler for totalisers	float32	2103	8451	1dp
VirtualChannel.11.Trend.Colour	As VirtualChannel1.Trend.Colour	uint8	2120	8480	Not applicable
VirtualChannel.11.Trend.SpanHigh	Specifies the highest PV (output value) to be displayed	float32	2122	8482	Same as VirtualChannel.11.Main.PV
VirtualChannel.11.Trend.SpanLow	Specifies the lowest PV (output value) to be displayed	float32	2121	8481	Same as VirtualChannel.11.Main.PV
VirtualChannel.12.Alarm1.Acknowledge	1 = acknowledge alarm	bool	01d6	470	Not applicable
VirtualChannel.12.Alarm1.Acknowledgement	1 = alarm acknowledged	bool	21d0	8656	Not applicable
VirtualChannel.12.Alarm1.Active	1 = alarm source active, or safe but not ack'd	bool	21cb	8651	Not applicable
VirtualChannel.12.Alarm1.Amount	Rate-of-change alarm 'Amount'	float32	21c8	8648	Same as VirtualChannel.12.Main.PV
VirtualChannel.12.Alarm1.AverageTime	Rate-of-change alarm 'Average time'	time_t	21ca	8650	Set by Network.Modbus.TimeFormat
VirtualChannel.12.Alarm1.Block	0 = Blocking alarms off; 1 = Blocking alarms on	uint8	21c2	8642	Not applicable
VirtualChannel.12.Alarm1.ChangeTime	Rate-of-change alarm 'Change Time'	uint8	21c9	8649	Not applicable
VirtualChannel.12.Alarm1.Deviation	Deviation alarm 'Deviation Value'	float32	21c7	8647	Same as VirtualChannel.12.Main.PV
VirtualChannel.12.Alarm1.Dwell	Alarm dwell time	time_t	21c5	8645	Set by Network.Modbus.TimeFormat
VirtualChannel.12.Alarm1.Hysteresis	Alarm hysteresis value	float32	21c4	8644	Same as VirtualChannel.12.Main.PV
VirtualChannel.12.Alarm1.Inactive	1 = alarm source safe and ack'd (if necessary)	bool	21ce	8654	Not applicable
VirtualChannel.12.Alarm1.Inhibit	1 = alarm inhibited	bool	21d1	8657	Not applicable

Parameter path	Description	Type	Hex	Dec	Resolution
VirtualChannel.12.Alarm1.NotAcknowledged	1 = alarm has not been acknowledged	bool	21cf	8655	Not applicable
VirtualChannel.12.Alarm1.Reference	Deviation alarm 'Reference' value	float32	21c6	8646	Same as VirtualChannel.12.Main.PV
VirtualChannel.12.Alarm1.Status	As VirtualChannel1.Alarm1.Status	uint8	014e	334	Not applicable
VirtualChannel.12.Alarm1.Threshold	Alarm trigger threshold	float32	21c3	8643	Same as VirtualChannel.12.Main.PV
VirtualChannel.12.Alarm1.Type	As VirtualChannel1.Alarm1.Type	uint8	21c0	8640	Not applicable
VirtualChannel.12.Alarm2.Acknowledge	1 = acknowledge alarm	bool	01d7	471	Not applicable
VirtualChannel.12.Alarm2.Acknowledgement	1 = alarm acknowledged	bool	21f0	8688	Not applicable
VirtualChannel.12.Alarm2.Active	1 = alarm source active, or safe but not ack'd	bool	21eb	8683	Not applicable
VirtualChannel.12.Alarm2.Amount	Rate-of-change alarm 'Amount'	float32	21e8	8680	Same as VirtualChannel.12.Main.PV
VirtualChannel.12.Alarm2.AverageTime	Rate-of-change alarm 'Average time'	time_t	21ea	8682	Set by Network.Modbus.TimeFormat
VirtualChannel.12.Alarm2.Block	0 = Blocking alarms off; 1 = Blocking alarms on	uint8	21e2	8674	Not applicable
VirtualChannel.12.Alarm2.ChangeTime	Rate-of-change alarm 'Change Time'	uint8	21e9	8681	Not applicable
VirtualChannel.12.Alarm2.Deviation	Deviation alarm 'Deviation Value'	float32	21e7	8679	Same as VirtualChannel.12.Main.PV
VirtualChannel.12.Alarm2.Dwell	Alarm dwell time	time_t	21e5	8677	Set by Network.Modbus.TimeFormat
VirtualChannel.12.Alarm2.Hysteresis	Alarm hysteresis value	float32	21e4	8676	Same as VirtualChannel.12.Main.PV
VirtualChannel.12.Alarm2.Inactive	1 = alarm source safe and ack'd (if necessary)	bool	21ee	8686	Not applicable
VirtualChannel.12.Alarm2.Inhibit	1 = alarm inhibited	bool	21f1	8689	Not applicable
VirtualChannel.12.Alarm2.Latch	As VirtualChannel1.Alarm1.Latch	uint8	21e1	8673	Not applicable
VirtualChannel.12.Alarm2.NotAcknowledged	1 = alarm has not been acknowledged	bool	21ef	8687	Not applicable
VirtualChannel.12.Alarm2.Reference	Deviation alarm 'Reference' value	float32	21e6	8678	Same as VirtualChannel.12.Main.PV
VirtualChannel.12.Alarm2.Status	As VirtualChannel1.Alarm1.Status	uint8	014f	335	Not applicable
VirtualChannel.12.Alarm2.Threshold	Alarm trigger threshold	float32	21e3	8675	Same as VirtualChannel.12.Main.PV
VirtualChannel.12.Alarm2.Type	As VirtualChannel1.Alarm1.Type	uint8	21e0	8672	Not applicable
VirtualChannel.12.Main.Descriptor	Virtual Channel descriptor	string_t	4c29	19497	Not applicable
VirtualChannel.12.Main.Disable	1 = Virtual channel disabled	bool	21a3	8611	Not applicable
VirtualChannel.12.Main.HighCutOff	The highest input value that will be totalised/counted	float32	2185	8581	Set by VirtualChannel.12.Main.Resolution
VirtualChannel.12.Main.Input1	Input 1 value	float32	2187	8583	Set by VirtualChannel.12.Main.Resolution
VirtualChannel.12.Main.Input2	Input 2 value	float32	2188	8584	Set by VirtualChannel.12.Main.Resolution
VirtualChannel.12.Main.LowCutOff	The lowest input value that will be totalised/counted	float32	2184	8580	Set by VirtualChannel.12.Main.Resolution
VirtualChannel.12.Main.ModbusInput	Modbus input value	float32	2186	8582	Set by VirtualChannel.12.Main.Resolution
VirtualChannel.12.Main.Operation	As VirtualChannel1.Main.Operation	uint8	2181	8577	Not applicable
VirtualChannel.12.Main.Period	The time period over which the calculation is made	int32	218a	8586	Not applicable
VirtualChannel.12.Main.Preset	Initiate preset. 0 = No; 1 = Yes	bool	218c	8588	Not applicable
VirtualChannel.12.Main.PresetValue	The Preset value	float32	218d	8589	Set by VirtualChannel.12.Main.Resolution
VirtualChannel.12.Main.PV	The virtual channel output value	float32	014c	332	Set by VirtualChannel.12.Main.Resolution
VirtualChannel.12.Main.Reset	Initiate reset. 0 = No; 1 = Yes	bool	218b	8587	Not applicable
VirtualChannel.12.Main.Resolution	Number of decimal places (0 to 6)	uint8	2182	8578	Not applicable
VirtualChannel.12.Main.Rollover	A pulse signal to indicate PV (output) has just rolled over	bool	2191	8593	Not applicable
VirtualChannel.12.Main.RolloverValue	Rollover value	float32	2192	8594	Set by VirtualChannel.12.Main.Resolution
VirtualChannel.12.Main.Status	As VirtualChannel1.Main.Status	uint8	014d	333	Not applicable
VirtualChannel.12.Main.TimeRemaining	Time remaining before the calculation is made	time_t	2189	8585	Set by Network.Modbus.TimeFormat
VirtualChannel.12.Main.Trigger	Increment/decrement counter. 0 = No; 1 = Yes	bool	218e	8590	Not applicable
VirtualChannel.12.Main.Type	As VirtualChannel1.Main.Type	uint8	2180	8576	Not applicable
VirtualChannel.12.Main.Units	Units descriptor	string_t	4c3e	19518	Not applicable
VirtualChannel.12.Main.UnitsScaler	Units scaler for totalisers	float32	2183	8579	1dp
VirtualChannel.12.Trend.Colour	As VirtualChannel1.Trend.Colour	uint8	21a0	8608	Not applicable
VirtualChannel.12.Trend.SpanHigh	Specifies the highest PV (output value) to be displayed	float32	21a2	8610	Same as VirtualChannel.12.Main.PV
VirtualChannel.12.Trend.SpanLow	Specifies the lowest PV (output value) to be displayed	float32	21a1	8609	Same as VirtualChannel.12.Main.PV
VirtualChannel.13.Alarm1.Acknowledge	1 = acknowledge alarm	bool	01d8	472	Not applicable
VirtualChannel.13.Alarm1.Acknowledgement	1 = alarm acknowledged	bool	2250	8784	Not applicable
VirtualChannel.13.Alarm1.Active	1 = alarm source active, or safe but not ack'd	bool	224b	8779	Not applicable
VirtualChannel.13.Alarm1.Amount	Rate-of-change alarm 'Amount'	float32	2248	8776	Same as VirtualChannel.13.Main.PV
VirtualChannel.13.Alarm1.AverageTime	Rate-of-change alarm 'Average time'	time_t	224a	8778	Set by Network.Modbus.TimeFormat
VirtualChannel.13.Alarm1.Block	0 = Blocking alarms off; 1 = Blocking alarms on	uint8	2242	8770	Not applicable
VirtualChannel.13.Alarm1.ChangeTime	Rate-of-change alarm 'Change Time'	uint8	2249	8777	Not applicable
VirtualChannel.13.Alarm1.Deviation	Deviation alarm 'Deviation Value'	float32	2247	8775	Same as VirtualChannel.13.Main.PV
VirtualChannel.13.Alarm1.Dwell	Alarm dwell time	time_t	2245	8773	Set by Network.Modbus.TimeFormat
VirtualChannel.13.Alarm1.Hysteresis	Alarm hysteresis value	float32	2244	8772	Same as VirtualChannel.13.Main.PV
VirtualChannel.13.Alarm1.Inhibit	1 = alarm inhibited	bool	2251	8785	Not applicable
VirtualChannel.13.Alarm1.Inactive	1 = alarm source safe and ack'd (if necessary)	bool	224e	8782	Not applicable

Parameter path	Description	Type	Hex	Dec	Resolution
VirtualChannel.13.Alarm1.NotAcknowledged	1 = alarm has not been acknowledged	bool	224f	8783	Not applicable
VirtualChannel.13.Alarm1.Reference	Deviation alarm 'Reference' value	float32	2246	8774	Same as VirtualChannel.13.Main.PV
VirtualChannel.13.Alarm1.Status	As VirtualChannel1.Alarm1.Status	uint8	0152	338	Not applicable
VirtualChannel.13.Alarm1.Threshold	Alarm trigger threshold	float32	2243	8771	Same as VirtualChannel.13.Main.PV
VirtualChannel.13.Alarm1.Type	As VirtualChannel1.Alarm1.Type	uint8	2240	8768	Not applicable
VirtualChannel.13.Alarm2.Acknowledge	1 = acknowledge alarm	bool	01d9	473	Not applicable
VirtualChannel.13.Alarm2.Acknowledgement	1 = alarm acknowledged	bool	2270	8816	Not applicable
VirtualChannel.13.Alarm2.Active	1 = alarm source active, or safe but not ack'd	bool	226b	8811	Not applicable
VirtualChannel.13.Alarm2.Amount	Rate-of-change alarm 'Amount'	float32	2268	8808	Same as VirtualChannel.13.Main.PV
VirtualChannel.13.Alarm2.AverageTime	Rate-of-change alarm 'Average time'	time_t	226a	8810	Set by Network.Modbus.TimeFormat
VirtualChannel.13.Alarm2.Block	0 = Blocking alarms off; 1 = Blocking alarms on	uint8	2262	8802	Not applicable
VirtualChannel.13.Alarm2.ChangeTime	Rate-of-change alarm 'Change Time'	uint8	2269	8809	Not applicable
VirtualChannel.13.Alarm2.Deviation	Deviation alarm 'Deviation Value'	float32	2267	8807	Same as VirtualChannel.13.Main.PV
VirtualChannel.13.Alarm2.Dwell	Alarm dwell time	time_t	2265	8805	Set by Network.Modbus.TimeFormat
VirtualChannel.13.Alarm2.Hysteresis	Alarm hysteresis value	float32	2264	8804	Same as VirtualChannel.13.Main.PV
VirtualChannel.13.Alarm2.Inactive	1 = alarm source safe and ack'd (if necessary)	bool	226e	8814	Not applicable
VirtualChannel.13.Alarm2.Inhibit	1 = alarm inhibited	bool	2271	8817	Not applicable
VirtualChannel.13.Alarm2.Latch	As VirtualChannel1.Alarm1.Latch	uint8	2261	8801	Not applicable
VirtualChannel.13.Alarm2.NotAcknowledged	1 = alarm has not been acknowledged	bool	226f	8815	Not applicable
VirtualChannel.13.Alarm2.Reference	Deviation alarm 'Reference' value	float32	2266	8806	Same as VirtualChannel.13.Main.PV
VirtualChannel.13.Alarm2.Status	As VirtualChannel1.Alarm1.Status	uint8	0153	339	Not applicable
VirtualChannel.13.Alarm2.Threshold	Alarm trigger threshold	float32	2263	8803	Same as VirtualChannel.13.Main.PV
VirtualChannel.13.Alarm2.Type	As VirtualChannel1.Alarm1.Type	uint8	2260	8800	Not applicable
VirtualChannel.13.Main.Descriptor	Virtual Channel descriptor	string_t	4c44	19524	Not applicable
VirtualChannel.13.Main.Disable	1 = Virtual channel disabled	bool	2223	8739	Not applicable
VirtualChannel.13.Main.HighCutOff	The highest input value that will be totalised/counted	float32	2205	8709	Set by VirtualChannel.13.Main.Resolution
VirtualChannel.13.Main.Input1	Input 1 value	float32	2207	8711	Set by VirtualChannel.13.Main.Resolution
VirtualChannel.13.Main.Input2	Input 2 value	float32	2208	8712	Set by VirtualChannel.13.Main.Resolution
VirtualChannel.13.Main.LowCutOff	The lowest input value that will be totalised/counted	float32	2204	8708	Set by VirtualChannel.13.Main.Resolution
VirtualChannel.13.Main.ModbusInput	Modbus input value	float32	2206	8710	Set by VirtualChannel.13.Main.Resolution
VirtualChannel.13.Main.Operation	As VirtualChannel1.Main.Operation	uint8	2201	8705	Not applicable
VirtualChannel.13.Main.Period	The time period over which the calculation is made	int32	220a	8714	Not applicable
VirtualChannel.13.Main.Preset	Initiate preset. 0 = No; 1 = Yes	bool	220c	8716	Not applicable
VirtualChannel.13.Main.PresetValue	The Preset value	float32	220d	8717	Set by VirtualChannel.13.Main.Resolution
VirtualChannel.13.Main.PV	The virtual channel output value	float32	0150	336	Set by VirtualChannel.13.Main.Resolution
VirtualChannel.13.Main.Reset	Initiate reset. 0 = No; 1 = Yes	bool	220b	8715	Not applicable
VirtualChannel.13.Main.Resolution	Number of decimal places (0 to 6)	uint8	2202	8706	Not applicable
VirtualChannel.13.Main.Rollover	A pulse signal to indicate PV (output) has just rolled over	bool	2211	8721	Not applicable
VirtualChannel.13.Main.RolloverValue	Rollover value	float32	2212	8722	Set by VirtualChannel.13.Main.Resolution
VirtualChannel.13.Main.Status	As VirtualChannel1.Main.Status	uint8	0151	337	Not applicable
VirtualChannel.13.Main.TimeRemaining	Time remaining before the calculation is made	time_t	2209	8713	Set by Network.Modbus.TimeFormat
VirtualChannel.13.Main.Trigger	Increment/decrement counter. 0 = No; 1 = Yes	bool	220e	8718	Not applicable
VirtualChannel.13.Main.Type	As VirtualChannel1.Main.Type	uint8	2200	8704	Not applicable
VirtualChannel.13.Main.Units	Units descriptor	string_t	4c59	19545	Not applicable
VirtualChannel.13.Main.UnitsScaler	Units scaler for totalisers	float32	2203	8707	1dp
VirtualChannel.13.Trend.Colour	As VirtualChannel1.Trend.Colour	uint8	2220	8736	Not applicable
VirtualChannel.13.Trend.SpanHigh	Specifies the highest PV (output value) to be displayed	float32	2222	8738	Same as VirtualChannel.13.Main.PV
VirtualChannel.13.Trend.SpanLow	Specifies the lowest PV (output value) to be displayed	float32	2221	8737	Same as VirtualChannel.13.Main.PV
VirtualChannel.14.Alarm1.Acknowledge	1 = acknowledge alarm	bool	01da	474	Not applicable
VirtualChannel.14.Alarm1.Acknowledgement	1 = alarm acknowledged	bool	22d0	8912	Not applicable
VirtualChannel.14.Alarm1.Active	1 = alarm source active, or safe but not ack'd	bool	22cb	8907	Not applicable
VirtualChannel.14.Alarm1.Amount	Rate-of-change alarm 'Amount'	float32	22c8	8904	Same as VirtualChannel.14.Main.PV
VirtualChannel.14.Alarm1.AverageTime	Rate-of-change alarm 'Average time'	time_t	22ca	8906	Set by Network.Modbus.TimeFormat
VirtualChannel.14.Alarm1.Block	0 = Blocking alarms off; 1 = Blocking alarms on	uint8	22c2	8898	Not applicable
VirtualChannel.14.Alarm1.ChangeTime	Rate-of-change alarm 'Change Time'	uint8	22c9	8905	Not applicable
VirtualChannel.14.Alarm1.Deviation	Deviation alarm 'Deviation Value'	float32	22c7	8903	Same as VirtualChannel.14.Main.PV
VirtualChannel.14.Alarm1.Dwell	Alarm dwell time	time_t	22c5	8901	Set by Network.Modbus.TimeFormat
VirtualChannel.14.Alarm1.Hysteresis	Alarm hysteresis value	float32	22c4	8900	Same as VirtualChannel.14.Main.PV
VirtualChannel.14.Alarm1.Inactive	1 = alarm source safe and ack'd (if necessary)	bool	22ce	8910	Not applicable
VirtualChannel.14.Alarm1.Inhibit	1 = alarm inhibited	bool	22d1	8913	Not applicable

Parameter path	Description	Type	Hex	Dec	Resolution
VirtualChannel.14.Alarm1.NotAcknowledged	1 = alarm has not been acknowledged	bool	22cf	8911	Not applicable
VirtualChannel.14.Alarm1.Reference	Deviation alarm 'Reference' value	float32	22c6	8902	Same as VirtualChannel.14.Main.PV
VirtualChannel.14.Alarm1.Status	As VirtualChannel1.Alarm1.Status	uint8	0156	342	Not applicable
VirtualChannel.14.Alarm1.Threshold	Alarm trigger threshold	float32	22c3	8899	Same as VirtualChannel.14.Main.PV
VirtualChannel.14.Alarm1.Type	As VirtualChannel1.Alarm1.Type	uint8	22c0	8896	Not applicable
VirtualChannel.14.Alarm2.Acknowledge	1 = acknowledge alarm	bool	01db	475	Not applicable
VirtualChannel.14.Alarm2.Acknowledgement	1 = alarm acknowledged	bool	22f0	8944	Not applicable
VirtualChannel.14.Alarm2.Active	1 = alarm source active, or safe but not ack'd	bool	22eb	8939	Not applicable
VirtualChannel.14.Alarm2.Amount	Rate-of-change alarm 'Amount'	float32	22e8	8936	Same as VirtualChannel.14.Main.PV
VirtualChannel.14.Alarm2.AverageTime	Rate-of-change alarm 'Average time'	time_t	22ea	8938	Set by Network.Modbus.TimeFormat
VirtualChannel.14.Alarm2.Block	0 = Blocking alarms off; 1 = Blocking alarms on	uint8	22e2	8930	Not applicable
VirtualChannel.14.Alarm2.ChangeTime	Rate-of-change alarm 'Change Time'	uint8	22e9	8937	Not applicable
VirtualChannel.14.Alarm2.Deviation	Deviation alarm 'Deviation Value'	float32	22e7	8935	Same as VirtualChannel.14.Main.PV
VirtualChannel.14.Alarm2.Dwell	Alarm dwell time	time_t	22e5	8933	Set by Network.Modbus.TimeFormat
VirtualChannel.14.Alarm2.Hysteresis	Alarm hysteresis value	float32	22e4	8932	Same as VirtualChannel.14.Main.PV
VirtualChannel.14.Alarm2.Inactive	1 = alarm source safe and ack'd (if necessary)	bool	22ee	8942	Not applicable
VirtualChannel.14.Alarm2.Inhibit	1 = alarm inhibited	bool	22f1	8945	Not applicable
VirtualChannel.14.Alarm2.Latch	As VirtualChannel1.Alarm1.Latch	uint8	22e1	8929	Not applicable
VirtualChannel.14.Alarm2.NotAcknowledged	1 = alarm has not been acknowledged	bool	22ef	8943	Not applicable
VirtualChannel.14.Alarm2.Reference	Deviation alarm 'Reference' value	float32	22e6	8934	Same as VirtualChannel.14.Main.PV
VirtualChannel.14.Alarm2.Status	As VirtualChannel1.Alarm1.Status	uint8	0157	343	Not applicable
VirtualChannel.14.Alarm2.Threshold	Alarm trigger threshold	float32	22e3	8931	Same as VirtualChannel.14.Main.PV
VirtualChannel.14.Alarm2.Type	As VirtualChannel1.Alarm1.Type	uint8	22e0	8928	Not applicable
VirtualChannel.14.Main.Descriptor	Virtual Channel descriptor	string_t	4c5f	19551	Not applicable
VirtualChannel.14.Main.Disable	1 = Virtual channel disabled	bool	22a3	8867	Not applicable
VirtualChannel.14.Main.HighCutOff	The highest input value that will be totalised/counted	float32	2285	8837	Set by VirtualChannel.14.Main.Resolution
VirtualChannel.14.Main.Input1	Input 1 value	float32	2287	8839	Set by VirtualChannel.14.Main.Resolution
VirtualChannel.14.Main.Input2	Input 2 value	float32	2288	8840	Set by VirtualChannel.14.Main.Resolution
VirtualChannel.14.Main.LowCutOff	The lowest input value that will be totalised/counted	float32	2284	8836	Set by VirtualChannel.14.Main.Resolution
VirtualChannel.14.Main.ModbusInput	Modbus input value	float32	2286	8838	Set by VirtualChannel.14.Main.Resolution
VirtualChannel.14.Main.Operation	As VirtualChannel1.Main.Operation	uint8	2281	8833	Not applicable
VirtualChannel.14.Main.Period	The time period over which the calculation is made	int32	228a	8842	Not applicable
VirtualChannel.14.Main.Preset	Initiate preset. 0 = No; 1 = Yes	bool	228c	8844	Not applicable
VirtualChannel.14.Main.PresetValue	The preset value	float32	228d	8845	Set by VirtualChannel.14.Main.Resolution
VirtualChannel.14.Main.PV	The virtual channel output value	float32	0154	340	Set by VirtualChannel.14.Main.Resolution
VirtualChannel.14.Main.Reset	Initiate reset. 0 = No; 1 = Yes	bool	228b	8843	Not applicable
VirtualChannel.14.Main.Resolution	Number of decimal places (0 to 6)	uint8	2282	8834	Not applicable
VirtualChannel.14.Main.Rollover	A pulse signal to indicate PV (output) has just rolled over	bool	2291	8849	Not applicable
VirtualChannel.14.Main.RolloverValue	Rollover value	float32	2292	8850	Set by VirtualChannel.14.Main.Resolution
VirtualChannel.14.Main.Status	As VirtualChannel1.Main.Status	uint8	0155	341	Not applicable
VirtualChannel.14.Main.TimeRemaining	Time remaining before the calculation is made	time_t	2289	8841	Set by Network.Modbus.TimeFormat
VirtualChannel.14.Main.Trigger	Increment/decrement counter. 0 = No; 1 = Yes	bool	228e	8846	Not applicable
VirtualChannel.14.Main.Type	As VirtualChannel1.Main.Type	uint8	2280	8832	Not applicable
VirtualChannel.14.Main.Units	Units descriptor	string_t	4c75	19573	Not applicable
VirtualChannel.14.Main.UnitsScaler	Units scaler for totalisers	float32	2283	8835	1dp
VirtualChannel.14.Trend.Colour	As VirtualChannel1.Trend.Colour	uint8	22a0	8864	Not applicable
VirtualChannel.14.Trend.SpanHigh	Specifies the highest PV (output value) to be displayed	float32	22a2	8866	Same as VirtualChannel.14.Main.PV
VirtualChannel.14.Trend.SpanLow	Specifies the lowest PV (output value) to be displayed	float32	22a1	8865	Same as VirtualChannel.14.Main.PV
VirtualChannel.15.Alarm1.Acknowledge	1 = acknowledge alarm	bool	01de	478	Not applicable
VirtualChannel.15.Alarm1.Acknowledgement	1 = alarm acknowledged	bool	2350	9040	Not applicable
VirtualChannel.15.Alarm1.Active	1 = alarm source active, or safe but not ack'd	bool	234b	9035	Not applicable
VirtualChannel.15.Alarm1.Amount	Rate-of-change alarm 'Amount'	float32	2348	9032	Same as VirtualChannel.15.Main.PV
VirtualChannel.15.Alarm1.AverageTime	Rate-of-change alarm 'Average time'	time_t	234a	9034	Set by Network.Modbus.TimeFormat
VirtualChannel.15.Alarm1.Block	0 = Blocking alarms off; 1 = Blocking alarms on	uint8	2342	9026	Not applicable
VirtualChannel.15.Alarm1.ChangeTime	Rate-of-change alarm 'Change Time'	uint8	2349	9033	Not applicable
VirtualChannel.15.Alarm1.Deviation	Deviation alarm 'Deviation Value'	float32	2347	9031	Same as VirtualChannel.15.Main.PV
VirtualChannel.15.Alarm1.Dwell	Alarm dwell time	time_t	2345	9029	Set by Network.Modbus.TimeFormat
VirtualChannel.15.Alarm1.Hysteresis	Alarm hysteresis value	float32	2344	9028	Same as VirtualChannel.15.Main.PV
VirtualChannel.15.Alarm1.Inactive	1 = alarm source safe and ack'd (if necessary)	bool	234e	9038	Not applicable
VirtualChannel.15.Alarm1.Inhibit	1 = Alarm inhibited	bool	2351	9041	Not applicable

Parameter path	Description	Type	Hex	Dec	Resolution
VirtualChannel.15.Alarm1.NotAcknowledged	1 = alarm has not been acknowledged	bool	234f	9039	Not applicable
VirtualChannel.15.Alarm1.Reference	Deviation alarm 'Reference' value	float32	2346	9030	Same as VirtualChannel.15.Main.PV
VirtualChannel.15.Alarm1.Status	As VirtualChannel1.Alarm1.Status	uint8	015a	346	Not applicable
VirtualChannel.15.Alarm1.Threshold	Alarm trigger threshold	float32	2343	9027	Same as VirtualChannel.15.Main.PV
VirtualChannel.15.Alarm1.Type	As VirtualChannel1.Alarm1.Type	uint8	2340	9024	Not applicable
VirtualChannel.15.Alarm2.Acknowledge	1 = acknowledge alarm	bool	01dd	477	Not applicable
VirtualChannel.15.Alarm2.Acknowledgement	1 = alarm acknowledged	bool	2370	9072	Not applicable
VirtualChannel.15.Alarm2.Active	1 = alarm source active, or safe but not ack'd	bool	236b	9067	Not applicable
VirtualChannel.15.Alarm2.Amount	Rate-of-change alarm 'Amount'	float32	2368	9064	Same as VirtualChannel.15.Main.PV
VirtualChannel.15.Alarm2.AverageTime	Rate-of-change alarm 'Average time'	time_t	236a	9066	Set by Network.Modbus.TimeFormat
VirtualChannel.15.Alarm2.Block	0 = Blocking alarms off; 1 = Blocking alarms on	uint8	2362	9058	Not applicable
VirtualChannel.15.Alarm2.ChangeTime	Rate-of-change alarm 'Change Time'	uint8	2369	9065	Not applicable
VirtualChannel.15.Alarm2.Deviation	Deviation alarm 'Deviation Value'	float32	2367	9063	Same as VirtualChannel.15.Main.PV
VirtualChannel.15.Alarm2.Dwell	Alarm dwell time	time_t	2365	9061	Set by Network.Modbus.TimeFormat
VirtualChannel.15.Alarm2.Hysteresis	Alarm hysteresis value	float32	2364	9060	Same as VirtualChannel.15.Main.PV
VirtualChannel.15.Alarm2.Inactive	1 = alarm source safe and ack'd (if necessary)	bool	236e	9070	Not applicable
VirtualChannel.15.Alarm2.Inhibit	1 = alarm inhibited	bool	2371	9073	Not applicable
VirtualChannel.15.Alarm2.Latch	As VirtualChannel1.Alarm1.Latch	uint8	2361	9057	Not applicable
VirtualChannel.15.Alarm2.NotAcknowledged	1 = alarm has not been acknowledged	bool	236f	9071	Not applicable
VirtualChannel.15.Alarm2.Reference	Deviation alarm 'Reference' value	float32	2366	9062	Same as VirtualChannel.15.Main.PV
VirtualChannel.15.Alarm2.Status	As VirtualChannel1.Alarm1.Status	uint8	015b	347	Not applicable
VirtualChannel.15.Alarm2.Threshold	Alarm trigger threshold	float32	2363	9059	Same as VirtualChannel.15.Main.PV
VirtualChannel.15.Alarm2.Type	As VirtualChannel1.Alarm1.Type	uint8	2360	9056	Not applicable
VirtualChannel.15.Main.Descriptor	Virtual Channel descriptor	string_t	4c7b	19579	Not applicable
VirtualChannel.15.Main.Disable	1 = Virtual channel disabled	bool	2323	8995	Not applicable
VirtualChannel.15.Main.HighCutOff	The highest input value that will be totalised/counted	float32	2305	8965	Set by VirtualChannel.15.Main.Resolution
VirtualChannel.15.Main.Input1	Input 1 value	float32	2307	8967	Set by VirtualChannel.15.Main.Resolution
VirtualChannel.15.Main.Input2	Input 2 value	float32	2308	8968	Set by VirtualChannel.15.Main.Resolution
VirtualChannel.15.Main.LowCutOff	The lowest input value that will be totalised/counted	float32	2304	8964	Set by VirtualChannel.15.Main.Resolution
VirtualChannel.15.Main.ModbusInput	Modbus input value	float32	2306	8966	Set by VirtualChannel.15.Main.Resolution
VirtualChannel.15.Main.Operation	Specifies the operation of the virtual channel	uint8	2301	8961	Not applicable
VirtualChannel.15.Main.Period	The time period over which the calculation is made	int32	230a	8970	Not applicable
VirtualChannel.15.Main.Preset	Initiate preset. 0 = No; 1 = Yes	bool	230c	8972	Not applicable
VirtualChannel.15.Main.PresetValue	Specifies the preset value	float32	230d	8973	Set by VirtualChannel.15.Main.Resolution
VirtualChannel.15.Main.PV	The virtual channel output value	float32	0158	344	Set by VirtualChannel.15.Main.Resolution
VirtualChannel.15.Main.Reset	Initiate reset. 0 = No; 1 = Yes	bool	230b	8971	Not applicable
VirtualChannel.15.Main.Resolution	Specifies the resolution/number of decimal places	uint8	2302	8962	Not applicable
VirtualChannel.15.Main.Rollover	A pulse signal to indicate PV (output) has just rolled over	bool	2311	8977	Not applicable
VirtualChannel.15.Main.RolloverValue	Rollover value	float32	2312	8978	Set by VirtualChannel.15.Main.Resolution
VirtualChannel.15.Main.Status	As VirtualChannel1.Main.Status	uint8	0159	345	Not applicable
VirtualChannel.15.Main.TimeRemaining	Time remaining before the calculation is made	time_t	2309	8969	Set by Network.Modbus.TimeFormat
VirtualChannel.15.Main.Trigger	Increment/decrement counter. 0 = No; 1 = Yes	bool	230e	8974	Not applicable
VirtualChannel.15.Main.Type	As VirtualChannel1.Main.Type	uint8	2300	8960	Not applicable
VirtualChannel.15.Main.Units	Units descriptor	string_t	4c90	19600	Not applicable
VirtualChannel.15.Main.UnitsScaler	Units scaler for totalisers	float32	2303	8963	1dp
VirtualChannel.15.Trend.Colour	As VirtualChannel1.Trend.Colour	uint8	2320	8992	Not applicable
VirtualChannel.15.Trend.SpanHigh	Specifies the highest PV (output value) to be displayed	float32	2322	8994	Same as VirtualChannel.15.Main.PV
VirtualChannel.15.Trend.SpanLow	Specifies the lowest PV (output value) to be displayed	float32	2321	8993	Same as VirtualChannel.15.Main.PV
VirtualChannel.16.Main.Descriptor	Virtual Channel descriptor	string_t	4c96	19606	Not applicable
VirtualChannel.16.Main.Disable	1 = Virtual channel disabled	bool	23a3	9123	Not applicable
VirtualChannel.16.Main.HighCutOff	The highest input value that will be totalised/counted	float32	2385	9093	Set by VirtualChannel.16.Main.Resolution
VirtualChannel.16.Main.Input1	Input 1 value	float32	2387	9095	Set by VirtualChannel.16.Main.Resolution
VirtualChannel.16.Main.Input2	Input 2 value	float32	2388	9096	Set by VirtualChannel.16.Main.Resolution
VirtualChannel.16.Main.LowCutOff	The lowest input value that will be totalised/counted	float32	2384	9092	Set by VirtualChannel.16.Main.Resolution
VirtualChannel.16.Main.ModbusInput	Modbus input value	float32	2386	9094	Set by VirtualChannel.16.Main.Resolution
VirtualChannel.16.Main.Operation	Specifies the operation of the virtual channel	uint8	2381	9089	Not applicable
VirtualChannel.16.Main.Period	The time period over which the calculation is made	int32	238a	9098	Not applicable
VirtualChannel.16.Main.Preset	Initiate preset. 0 = No; 1 = Yes	bool	238c	9100	Not applicable
VirtualChannel.16.Main.PresetValue	Specifies the preset value	float32	238d	9101	Set by VirtualChannel.16.Main.Resolution
VirtualChannel.16.Main.PV	The virtual channel output value	float32	015c	348	Set by VirtualChannel.16.Main.Resolution
VirtualChannel.16.Main.Reset	Initiate reset. 0 = No; 1 = Yes	bool	238b	9099	Not applicable

Parameter path	Description	Type	Hex	Dec	Resolution
VirtualChannel.16.Main.Rollover	A pulse signal to indicate PV (output) has just rolled over	bool	2391	9105	Not applicable
VirtualChannel.16.Main.RolloverValue	Rollover value	float32	2392	9106	Set by VirtualChannel.16.Main.Resolution
VirtualChannel.16.Main.Status	As VirtualChannel1.Main.Status	uint8	015d	349	Not applicable
VirtualChannel.16.Main.TimeRemaining	Time remaining before the calculation is made	time_t	2389	9097	Set by Network.Modbus.TimeFormat
VirtualChannel.16.Main.Trigger	Increment/decrement counter. 0 = No; 1 = Yes	bool	238e	9102	Not applicable
VirtualChannel.16.Main.Type	As VirtualChannel1.Main.Type	uint8	2380	9088	Not applicable
VirtualChannel.16.Main.Units	Units descriptor	string_t	4cab	19627	Not applicable
VirtualChannel.16.Main.UnitsScaler	Units scaler for totalisers	float32	2383	9091	1dp
VirtualChannel.16.Trend.Colour	As VirtualChannel1.Trend.Colour	uint8	23a0	9120	Not applicable
VirtualChannel.16.Trend.SpanHigh	Specifies the highest PV (output value) to be displayed	float32	23a2	9122	Same as VirtualChannel.16.Main.PV
VirtualChannel.16.Trend.SpanLow	Specifies the lowest PV (output value) to be displayed	float32	23a1	9121	Same as VirtualChannel.16.Main.PV
VirtualChannel.17.Main.Descriptor	Virtual Channel descriptor	string_t	4cb1	19633	Not applicable
VirtualChannel.17.Main.Disable	1 = Virtual channel disabled	bool	23e3	9187	Not applicable
VirtualChannel.17.Main.HighCutOff	The highest input value that will be totalised/counted	float32	23c5	9157	Set by VirtualChannel.17.Main.Resolution
VirtualChannel.17.Main.Input1	Input 1 value	float32	23c7	9159	Set by VirtualChannel.17.Main.Resolution
VirtualChannel.17.Main.Input2	Input 2 value	float32	23c8	9160	Set by VirtualChannel.17.Main.Resolution
VirtualChannel.17.Main.LowCutOff	The lowest input value that will be totalised/counted	float32	23c4	9156	Set by VirtualChannel.17.Main.Resolution
VirtualChannel.17.Main.ModbusInput	Modbus input value	float32	23c6	9158	Set by VirtualChannel.17.Main.Resolution
VirtualChannel.17.Main.Operation	Specifies the operation of the virtual channel	uint8	23c1	9153	Not applicable
VirtualChannel.17.Main.Period	The time period over which the calculation is made	int32	23ca	9162	Not applicable
VirtualChannel.17.Main.Preset	Initiate preset. 0 = No; 1 = Yes	bool	23cc	9164	Not applicable
VirtualChannel.17.Main.PresetValue	Specifies the preset value	float32	23cd	9165	Set by VirtualChannel.17.Main.Resolution
VirtualChannel.17.Main.PV	The virtual channel output value	float32	015e	350	Set by VirtualChannel.17.Main.Resolution
VirtualChannel.17.Main.Reset	Initiate reset. 0 = No; 1 = Yes	bool	23cb	9163	Not applicable
VirtualChannel.17.Main.Resolution	Specifies the resolution/number of decimal places	uint8	23c2	9154	Not applicable
VirtualChannel.17.Main.Rollover	A pulse signal to indicate PV (output) has just rolled over	bool	23d1	9169	Not applicable
VirtualChannel.17.Main.RolloverValue	Rollover value	float32	23d2	9170	Set by VirtualChannel.17.Main.Resolution
VirtualChannel.17.Main.Status	As VirtualChannel1.Main.Status	uint8	015f	351	Not applicable
VirtualChannel.17.Main.TimeRemaining	Time remaining before the calculation is made	time_t	23c9	9161	Set by Network.Modbus.TimeFormat
VirtualChannel.17.Main.Trigger	Increment/decrement counter. 0 = No; 1 = Yes	bool	23ce	9166	Not applicable
VirtualChannel.17.Main.Type	As VirtualChannel1.Main.Type	uint8	23c0	9152	Not applicable
VirtualChannel.17.Main.Units	Units descriptor	string_t	4cc6	19654	Not applicable
VirtualChannel.17.Main.UnitsScaler	Units scaler for totalisers	float32	23c3	9155	1dp
VirtualChannel.17.Trend.Colour	As VirtualChannel1.Trend.Colour	uint8	23e0	9184	Not applicable
VirtualChannel.17.Trend.SpanHigh	Specifies the highest PV (output value) to be displayed	float32	23e2	9186	Same as VirtualChannel.17.Main.PV
VirtualChannel.17.Trend.SpanLow	Specifies the lowest PV (output value) to be displayed	float32	23e1	9185	Same as VirtualChannel.17.Main.PV
VirtualChannel.18.Main.Descriptor	Virtual Channel descriptor	string_t	4ccc	19660	Not applicable
VirtualChannel.18.Main.Disable	1 = Virtual channel disabled	bool	2523	9507	Not applicable
VirtualChannel.18.Main.HighCutOff	The highest input value that will be totalised/counted	float32	2405	9221	Set by VirtualChannel.18.Main.Resolution
VirtualChannel.18.Main.Input1	Input 1 value	float32	2407	9223	Set by VirtualChannel.18.Main.Resolution
VirtualChannel.18.Main.Input2	Input 2 value	float32	2408	9224	Set by VirtualChannel.18.Main.Resolution
VirtualChannel.18.Main.LowCutOff	The lowest input value that will be totalised/counted	float32	2404	9220	Set by VirtualChannel.18.Main.Resolution
VirtualChannel.18.Main.ModbusInput	Modbus input value	float32	2406	9222	Set by VirtualChannel.18.Main.Resolution
VirtualChannel.18.Main.Operation	Specifies the operation of the virtual channel	uint8	2401	9217	Not applicable
VirtualChannel.18.Main.Period	The time period over which the calculation is made	int32	240a	9226	Not applicable
VirtualChannel.18.Main.Preset	Initiate preset. 0 = No; 1 = Yes	bool	240c	9228	Not applicable
VirtualChannel.18.Main.PresetValue	Specifies the preset value	float32	240d	9229	Set by VirtualChannel.18.Main.Resolution
VirtualChannel.18.Main.PV	The virtual channel output value	float32	0160	352	Set by VirtualChannel.18.Main.Resolution
VirtualChannel.18.Main.Reset	Initiate reset. 0 = No; 1 = Yes	bool	240b	9227	Not applicable
VirtualChannel.18.Main.Resolution	Specifies the resolution/number of decimal places	uint8	2402	9218	Not applicable
VirtualChannel.18.Main.Rollover	A pulse signal to indicate PV (output) has just rolled over	bool	2411	9233	Not applicable
VirtualChannel.18.Main.RolloverValue	Rollover value	float32	2412	9234	Set by VirtualChannel.18.Main.Resolution
VirtualChannel.18.Main.Status	As VirtualChannel1.Main.Status	uint8	0161	353	Not applicable
VirtualChannel.18.Main.TimeRemaining	Time remaining before the calculation is made	time_t	2409	9225	Set by Network.Modbus.TimeFormat
VirtualChannel.18.Main.Trigger	Increment/decrement counter. 0 = No; 1 = Yes	bool	240e	9230	Not applicable
VirtualChannel.18.Main.Type	As VirtualChannel1.Main.Type	uint8	2400	9216	Not applicable
VirtualChannel.18.Main.Units	Units descriptor	string_t	4ce1	19681	Not applicable
VirtualChannel.18.Main.UnitsScaler	Units scaler for totalisers	float32	2403	9219	1dp
VirtualChannel.18.Trend.Colour	As VirtualChannel1.Trend.Colour	uint8	2520	9504	Not applicable

Parameter path	Description	Type	Hex	Dec	Resolution
VirtualChannel.18.Trend.SpanLow	Specifies the lowest PV (output value) to be displayed	float32	2521	9505	Same as VirtualChannel.18.Main.PV
VirtualChannel.19.Main.Descriptor	Virtual Channel descriptor	string_t	4ce7	19687	Not applicable
VirtualChannel.19.Main.Disable	1 = Virtual channel disabled	bool	2563	9571	Not applicable
VirtualChannel.19.Main.HighCutOff	The highest input value that will be totalised/counted	float32	2445	9285	Set by VirtualChannel.19.Main.Resolution
VirtualChannel.19.Main.Input1	Input 1 value	float32	2447	9287	Set by VirtualChannel.19.Main.Resolution
VirtualChannel.19.Main.Input2	Input 2 value	float32	2448	9288	Set by VirtualChannel.19.Main.Resolution
VirtualChannel.19.Main.LowCutOff	The lowest input value that will be totalised/counted	float32	2444	9284	Set by VirtualChannel.19.Main.Resolution
VirtualChannel.19.Main.ModbusInput	Modbus input value	float32	2446	9286	Set by VirtualChannel.19.Main.Resolution
VirtualChannel.19.Main.Operation	Specifies the operation of the virtual channel	uint8	2441	9281	Not applicable
VirtualChannel.19.Main.Period	The time period over which the calculation is made	int32	244a	9290	Not applicable
VirtualChannel.19.Main.Preset	Initiate preset. 0 = No; 1 = Yes	bool	244c	9292	Not applicable
VirtualChannel.19.Main.PresetValue	Specifies the preset value	float32	244d	9293	Set by VirtualChannel.19.Main.Resolution
VirtualChannel.19.Main.PV	The virtual channel output value	float32	0162	354	Set by VirtualChannel.19.Main.Resolution
VirtualChannel.19.Main.Reset	Initiate reset. 0 = No; 1 = Yes	bool	244b	9291	Not applicable
VirtualChannel.19.Main.Resolution	Specifies the resolution/number of decimal places	uint8	2442	9282	Not applicable
VirtualChannel.19.Main.Rollover	A pulse signal to indicate PV (output) has just rolled over	bool	2451	9297	Not applicable
VirtualChannel.19.Main.RolloverValue	Rollover value	float32	2452	9298	Set by VirtualChannel.19.Main.Resolution
VirtualChannel.19.Main.Status	TAs VirtualChannel1.Main.Statusv	uint8	0163	355	Not applicable
VirtualChannel.19.Main.TimeRemaining	Time remaining before the calculation is made	time_t	2449	9289	Set by Network.Modbus.TimeFormat
VirtualChannel.19.Main.Trigger	Increment/decrement counter. 0 = No; 1 = Yes	bool	244e	9294	Not applicable
VirtualChannel.19.Main.Type	As VirtualChannel1.Main.Type	uint8	2440	9280	Not applicable
VirtualChannel.19.Main.Units	Units descriptor	string_t	4cfc	19708	Not applicable
VirtualChannel.19.Main.UnitsScaler	Units scaler for totalisers	float32	2443	9283	1dp
VirtualChannel.19.Trend.Colour	As VirtualChannel1.Trend.Colour	uint8	2560	9568	Not applicable
VirtualChannel.19.Trend.SpanHigh	Specifies the highest PV (output value) to be displayed	float32	2562	9570	Same as VirtualChannel.19.Main.PV
VirtualChannel.19.Trend.SpanLow	Specifies the lowest PV (output value) to be displayed	float32	2561	9569	Same as VirtualChannel.19.Main.PV
VirtualChannel.20.Main.Descriptor	Virtual Channel descriptor	string_t	4d02	19714	Not applicable
VirtualChannel.20.Main.Disable	1 = Virtual channel disabled	bool	25a3	9635	Not applicable
VirtualChannel.20.Main.HighCutOff	The highest input value that will be totalised/counted	float32	2485	9349	Set by VirtualChannel.20.Main.Resolution
VirtualChannel.20.Main.Input1	Input 1 value	float32	2487	9351	Set by VirtualChannel.20.Main.Resolution
VirtualChannel.20.Main.Input2	Input 2 value	float32	2488	9352	Set by VirtualChannel.20.Main.Resolution
VirtualChannel.20.Main.LowCutOff	The lowest input value that will be totalised/counted	float32	2484	9348	Set by VirtualChannel.20.Main.Resolution
VirtualChannel.20.Main.ModbusInput	Modbus input value	float32	2486	9350	Set by VirtualChannel.20.Main.Resolution
VirtualChannel.20.Main.Operation	Specifies the operation of the virtual channel	uint8	2481	9345	Not applicable
VirtualChannel.20.Main.Period	The time period over which the calculation is made	int32	248a	9354	Not applicable
VirtualChannel.20.Main.Preset	Initiate preset. 0 = No; 1 = Yes	bool	248c	9356	Not applicable
VirtualChannel.20.Main.PresetValue	Specifies the preset value	float32	248d	9357	Set by VirtualChannel.20.Main.Resolution
VirtualChannel.20.Main.PV	The virtual channel output value	float32	0164	356	Set by VirtualChannel.20.Main.Resolution
VirtualChannel.20.Main.Reset	Initiate reset. 0 = No; 1 = Yes	bool	248b	9355	Not applicable
VirtualChannel.20.Main.Resolution	Specifies the resolution/number of decimal places	uint8	2482	9346	Not applicable
VirtualChannel.20.Main.Rollover	A pulse signal to indicate PV (output) has just rolled over	bool	2491	9361	Not applicable
VirtualChannel.20.Main.RolloverValue	Rollover value	float32	2492	9362	Set by VirtualChannel.20.Main.Resolution
VirtualChannel.20.Main.Status	As VirtualChannel1.Main.Status	uint8	0165	357	Not applicable
VirtualChannel.20.Main.TimeRemaining	Time remaining before the calculation is made	time_t	2489	9353	Set by Network.Modbus.TimeFormat
VirtualChannel.20.Main.Trigger	Increment/decrement counter. 0 = No; 1 = Yes	bool	248e	9358	Not applicable
VirtualChannel.20.Main.Type	As VirtualChannel1.Main.Type	uint8	2480	9344	Not applicable
VirtualChannel.20.Main.Units	Units descriptor	string_t	4d17	19735	Not applicable
VirtualChannel.20.Main.UnitsScaler	Units scaler for totalisers	float32	2483	9347	1dp
VirtualChannel.20.Trend.Colour	As VirtualChannel1.Trend.Colour	uint8	25a0	9632	Not applicable
VirtualChannel.20.Trend.SpanHigh	Specifies the highest PV (output value) to be displayed	float32	25a2	9634	Same as VirtualChannel.20.Main.PV
VirtualChannel.20.Trend.SpanLow	Specifies the lowest PV (output value) to be displayed	float32	25a1	9633	Same as VirtualChannel.20.Main.PV
VirtualChannel.21.Main.Descriptor	Virtual Channel descriptor	string_t	4d1d	19741	Not applicable
VirtualChannel.21.Main.Disable	1 = Virtual channel disabled	bool	25e3	9699	Not applicable
VirtualChannel.21.Main.HighCutOff	The highest input value that will be totalised/counted	float32	24c5	9413	Set by VirtualChannel.21.Main.Resolution
VirtualChannel.21.Main.Input1	Input 1 value	float32	24c7	9415	Set by VirtualChannel.21.Main.Resolution
VirtualChannel.21.Main.Input2	Input 2 value	float32	24c8	9416	Set by VirtualChannel.21.Main.Resolution
VirtualChannel.21.Main.LowCutOff	The lowest input value that will be totalised/counted	float32	24c4	9412	Set by VirtualChannel.21.Main.Resolution
VirtualChannel.21.Main.ModbusInput	Modbus input value	float32	24c6	9414	Set by VirtualChannel.21.Main.Resolution

Parameter path	Description	Type	Hex	Dec	Resolution
VirtualChannel.21.Main.Period	The time period over which the calculation is made	int32	24ca	9418	Not applicable
VirtualChannel.21.Main.Preset	Initiate preset. 0 = No; 1 = Yes	bool	24cc	9420	Not applicable
VirtualChannel.21.Main.PresetValue	Specifies the preset value	float32	24cd	9421	Set by VirtualChannel.21.Main.Resolution
VirtualChannel.21.Main.PV	The virtual channel output value	float32	0166	358	Set by VirtualChannel.21.Main.Resolution
VirtualChannel.21.Main.Reset	Initiate reset. 0 = No; 1 = Yes	bool	24cb	9419	Not applicable
VirtualChannel.21.Main.Resolution	Specifies the resolution/number of decimal places	uint8	24c2	9410	Not applicable
VirtualChannel.21.Main.Rollover	A pulse signal to indicate PV (output) has just rolled over	bool	24d1	9425	Not applicable
VirtualChannel.21.Main.RolloverValue	Rollover value	float32	24d2	9426	Set by VirtualChannel.21.Main.Resolution
VirtualChannel.21.Main.Status	As VirtualChannel1.Main.Status	uint8	0167	359	Not applicable
VirtualChannel.21.Main.TimeRemaining	Time remaining before the calculation is made	time_t	24c9	9417	Set by Network.Modbus.TimeFormat
VirtualChannel.21.Main.Trigger	Increment/decrement counter. 0 = No; 1 = Yes	bool	24ce	9422	Not applicable
VirtualChannel.21.Main.Type	As VirtualChannel1.Main.Type	uint8	24c0	9408	Not applicable
VirtualChannel.21.Main.Units	Units descriptor	string_t	4d32	19762	Not applicable
VirtualChannel.21.Main.UnitsScaler	Units scaler for totalisers	float32	24c3	9411	1dp
VirtualChannel.21.Trend.Colour	As VirtualChannel1.Trend.Colour	uint8	25e0	9696	Not applicable
VirtualChannel.21.Trend.SpanHigh	Specifies the highest PV (output value) to be displayed	float32	25e2	9698	Same as VirtualChannel.21.Main.PV
VirtualChannel.21.Trend.SpanLow	Specifies the lowest PV (output value) to be displayed	float32	25e1	9697	Same as VirtualChannel.21.Main.PV
VirtualChannel.22.Main.Descriptor	Virtual Channel descriptor	string_t	4d38	19768	Not applicable
VirtualChannel.22.Main.Disable	1 = Virtual channel disabled	bool	2623	9763	Not applicable
VirtualChannel.22.Main.HighCutOff	The highest input value that will be totalised/counted	float32	2505	9477	Set by VirtualChannel.22.Main.Resolution
VirtualChannel.22.Main.Input1	Input 1 value	float32	2507	9479	Set by VirtualChannel.22.Main.Resolution
VirtualChannel.22.Main.Input2	Input 2 value	float32	2508	9480	Set by VirtualChannel.22.Main.Resolution
VirtualChannel.22.Main.LowCutOff	The lowest input value that will be totalised/counted	float32	2504	9476	Set by VirtualChannel.22.Main.Resolution
VirtualChannel.22.Main.ModbusInput	Modbus input value	float32	2506	9478	Set by VirtualChannel.22.Main.Resolution
VirtualChannel.22.Main.Operation	Specifies the operation of the virtual channel	uint8	2501	9473	Not applicable
VirtualChannel.22.Main.Period	The time period over which the calculation is made	int32	250a	9482	Not applicable
VirtualChannel.22.Main.Preset	Initiate preset. 0 = No; 1 = Yes	bool	250c	9484	Not applicable
VirtualChannel.22.Main.PresetValue	Specifies the preset value	float32	250d	9485	Set by VirtualChannel.22.Main.Resolution
VirtualChannel.22.Main.PV	The virtual channel output value	float32	0168	360	Set by VirtualChannel.22.Main.Resolution
VirtualChannel.22.Main.Reset	Initiate reset. 0 = No; 1 = Yes	bool	250b	9483	Not applicable
VirtualChannel.22.Main.Resolution	Specifies the resolution/number of decimal places	uint8	2502	9474	Not applicable
VirtualChannel.22.Main.Rollover	A pulse signal to indicate PV (output) has just rolled over	bool	2511	9489	Not applicable
VirtualChannel.22.Main.RolloverValue	Rollover value	float32	2512	9490	Set by VirtualChannel.22.Main.Resolution
VirtualChannel.22.Main.Status	As VirtualChannel1.Main.Status	uint8	0169	361	Not applicable
VirtualChannel.22.Main.TimeRemaining	Time remaining before the calculation is made	time_t	2509	9481	Set by Network.Modbus.TimeFormat
VirtualChannel.22.Main.Trigger	Increment/decrement counter. 0 = No; 1 = Yes	bool	250e	9486	Not applicable
VirtualChannel.22.Main.Type	As VirtualChannel1.Main.Type	uint8	2500	9472	Not applicable
VirtualChannel.22.Main.Units	Units descriptor	string_t	4d4d	19789	Not applicable
VirtualChannel.22.Main.UnitsScaler	Units scaler for totalisers	float32	2503	9475	1dp
VirtualChannel.22.Trend.Colour	As VirtualChannel1.Trend.Colour	uint8	2620	9760	Not applicable
VirtualChannel.22.Trend.SpanHigh	Specifies the highest PV (output value) to be displayed	float32	2622	9762	Same as VirtualChannel.22.Main.PV
VirtualChannel.22.Trend.SpanLow	Specifies the lowest PV (output value) to be displayed	float32	2621	9761	Same as VirtualChannel.22.Main.PV
VirtualChannel.23.Main.Descriptor	Virtual Channel descriptor	string_t	4d53	19795	Not applicable
VirtualChannel.23.Main.Disable	1 = Virtual channel disabled	bool	2663	9827	Not applicable
VirtualChannel.23.Main.HighCutOff	The highest input value that will be totalised/counted	float32	2545	9541	Set by VirtualChannel.23.Main.Resolution
VirtualChannel.23.Main.Input1	Input 1 value	float32	2547	9543	Set by VirtualChannel.23.Main.Resolution
VirtualChannel.23.Main.Input2	Input 2 value	float32	2548	9544	Set by VirtualChannel.23.Main.Resolution
VirtualChannel.23.Main.LowCutOff	The lowest input value that will be totalised/counted	float32	2544	9540	Set by VirtualChannel.23.Main.Resolution
VirtualChannel.23.Main.ModbusInput	Modbus input value	float32	2546	9542	Set by VirtualChannel.23.Main.Resolution
VirtualChannel.23.Main.Operation	Specifies the operation of the virtual channel	uint8	2541	9537	Not applicable
VirtualChannel.23.Main.Period	The time period over which the calculation is made	int32	254a	9546	Not applicable
VirtualChannel.23.Main.Preset	Initiate preset. 0 = No; 1 = Yes	bool	254c	9548	Not applicable
VirtualChannel.23.Main.PresetValue	Specifies the preset value	float32	254d	9549	Set by VirtualChannel.23.Main.Resolution
VirtualChannel.23.Main.PV	The virtual channel output value	float32	016a	362	Set by VirtualChannel.23.Main.Resolution
VirtualChannel.23.Main.Reset	Initiate reset. 0 = No; 1 = Yes	bool	254b	9547	Not applicable
VirtualChannel.23.Main.Resolution	Specifies the resolution/number of decimal places	uint8	2542	9538	Not applicable
VirtualChannel.23.Main.Rollover	A pulse signal to indicate PV (output) has just rolled over	bool	2551	9553	Not applicable
VirtualChannel.23.Main.RolloverValue	Rollover value	float32	2552	9554	Set by VirtualChannel.23.Main.Resolution
VirtualChannel.23.Main.Status	As VirtualChannel1.Main.Status	uint8	0168	360	Not applicable

Parameter path	Description	Type	Hex	Dec	Resolution
VirtualChannel.23.Main.Trigger	Increment/decrement counter. 0 = No; 1 = Yes	bool	254e	9550	Not applicable
VirtualChannel.23.Main.Type	As VirtualChannel1.Main.Type	uint8	2540	9536	Not applicable
VirtualChannel.23.Main.Units	Units descriptor	string_t	4d68	19816	Not applicable
VirtualChannel.23.Main.UnitsScaler	Units scaler for totalisers	float32	2543	9539	1dp
VirtualChannel.23.Trend.Colour	As VirtualChannel1.Trend.Colour	uint8	2660	9824	Not applicable
VirtualChannel.23.Trend.SpanHigh	Specifies the highest PV (output value) to be displayed	float32	2662	9826	Same as VirtualChannel.23.Main.PV
VirtualChannel.23.Trend.SpanLow	Specifies the lowest PV (output value) to be displayed	float32	2661	9825	Same as VirtualChannel.23.Main.PV
VirtualChannel.24.Main.Descriptor	Virtual Channel descriptor	string_t	4d6e	19822	Not applicable
VirtualChannel.24.Main.Disable	1 = Virtual channel disabled	bool	26a3	9891	Not applicable
VirtualChannel.24.Main.HighCutOff	The highest input value that will be totalised/counted	float32	2585	9605	Set by VirtualChannel.24.Main.Resolution
VirtualChannel.24.Main.Input1	Input 1 value	float32	2587	9607	Set by VirtualChannel.24.Main.Resolution
VirtualChannel.24.Main.Input2	Input 2 value	float32	2588	9608	Set by VirtualChannel.24.Main.Resolution
VirtualChannel.24.Main.LowCutOff	The lowest input value that will be totalised/counted	float32	2584	9604	Set by VirtualChannel.24.Main.Resolution
VirtualChannel.24.Main.ModbusInput	Modbus input value	float32	2586	9606	Set by VirtualChannel.24.Main.Resolution
VirtualChannel.24.Main.Operation	Specifies the operation of the virtual channel	uint8	2581	9601	Not applicable
VirtualChannel.24.Main.Period	The time period over which the calculation is made	int32	258a	9610	Not applicable
VirtualChannel.24.Main.Preset	Initiate preset. 0 = No; 1 = Yes	bool	258c	9612	Not applicable
VirtualChannel.24.Main.PresetValue	Specifies the preset value	float32	258d	9613	Set by VirtualChannel.24.Main.Resolution
VirtualChannel.24.Main.PV	The virtual channel output value	float32	016c	364	Set by VirtualChannel.24.Main.Resolution
VirtualChannel.24.Main.Reset	Initiate reset. 0 = No; 1 = Yes	bool	258b	9611	Not applicable
VirtualChannel.24.Main.Resolution	Specifies the resolution/number of decimal places	uint8	2582	9602	Not applicable
VirtualChannel.24.Main.Rollover	A pulse signal to indicate PV (output) has just rolled over	bool	2591	9617	Not applicable
VirtualChannel.24.Main.RolloverValue	Rollover value	float32	2592	9618	Set by VirtualChannel.24.Main.Resolution
VirtualChannel.24.Main.Status	As VirtualChannel1.Main.Status	uint8	016d	365	Not applicable
VirtualChannel.24.Main.TimeRemaining	Time remaining before the calculation is made	time_t	2589	9609	Set by Network.Modbus.TimeFormat
VirtualChannel.24.Main.Trigger	Increment/decrement counter. 0 = No; 1 = Yes	bool	258e	9614	Not applicable
VirtualChannel.24.Main.Type	As VirtualChannel1.Main.Type	uint8	2580	9600	Not applicable
VirtualChannel.24.Main.Units	Units descriptor	string_t	4d83	19843	Not applicable
VirtualChannel.24.Main.UnitsScaler	Units scaler for totalisers	float32	2583	9603	1dp
VirtualChannel.24.Trend.Colour	As VirtualChannel1.Trend.Colour	uint8	26a0	9888	Not applicable
VirtualChannel.24.Trend.SpanHigh	Specifies the highest PV (output value) to be displayed	float32	26a2	9890	Same as VirtualChannel.24.Main.PV
VirtualChannel.24.Trend.SpanLow	Specifies the lowest PV (output value) to be displayed	float32	26a1	9889	Same as VirtualChannel.24.Main.PV
VirtualChannel.25.Main.Descriptor	Virtual Channel descriptor	string_t	4d89	19849	Not applicable
VirtualChannel.25.Main.Disable	1 = Virtual channel disabled	bool	26e3	9955	Not applicable
VirtualChannel.25.Main.HighCutOff	The highest input value that will be totalised/counted	float32	25c5	9669	Set by VirtualChannel.25.Main.Resolution
VirtualChannel.25.Main.Input1	Input 1 value	float32	25c7	9671	Set by VirtualChannel.25.Main.Resolution
VirtualChannel.25.Main.Input2	Input 2 value	float32	25c8	9672	Set by VirtualChannel.25.Main.Resolution
VirtualChannel.25.Main.LowCutOff	The lowest input value that will be totalised/counted	float32	25c4	9668	Set by VirtualChannel.25.Main.Resolution
VirtualChannel.25.Main.ModbusInput	Modbus input value	float32	25c6	9670	Set by VirtualChannel.25.Main.Resolution
VirtualChannel.25.Main.Operation	Specifies the operation of the virtual channel	uint8	25c1	9665	Not applicable
VirtualChannel.25.Main.Period	The time period over which the calculation is made	int32	25ca	9674	Not applicable
VirtualChannel.25.Main.Preset	Initiate preset. 0 = No; 1 = Yes	bool	25cc	9676	Not applicable
VirtualChannel.25.Main.PresetValue	Specifies the preset value	float32	25cd	9677	Set by VirtualChannel.25.Main.Resolution
VirtualChannel.25.Main.PV	The virtual channel output value	float32	016e	366	Set by VirtualChannel.25.Main.Resolution
VirtualChannel.25.Main.Reset	Initiate reset. 0 = No; 1 = Yes	bool	25cb	9675	Not applicable
VirtualChannel.25.Main.Resolution	Specifies the resolution/number of decimal places	uint8	25c2	9666	Not applicable
VirtualChannel.25.Main.Rollover	A pulse signal to indicate PV (output) has just rolled over	bool	25d1	9681	Not applicable
VirtualChannel.25.Main.RolloverValue	Rollover value	float32	25d2	9682	Set by VirtualChannel.25.Main.Resolution
VirtualChannel.25.Main.Status	As VirtualChannel1.Main.Status	uint8	016f	367	Not applicable
VirtualChannel.25.Main.TimeRemaining	Time remaining before the calculation is made	time_t	25c9	9673	Set by Network.Modbus.TimeFormat
VirtualChannel.25.Main.Trigger	Increment/decrement counter. 0 = No; 1 = Yes	bool	25ce	9678	Not applicable
VirtualChannel.25.Main.Type	As VirtualChannel1.Main.Type	uint8	25c0	9664	Not applicable
VirtualChannel.25.Main.Units	Units descriptor	string_t	4d9e	19870	Not applicable
VirtualChannel.25.Main.UnitsScaler	Units scaler for totalisers	float32	25c3	9667	1dp
VirtualChannel.25.Trend.Colour	As VirtualChannel1.Trend.Colour	uint8	26e0	9952	Not applicable
VirtualChannel.25.Trend.SpanHigh	Specifies the highest PV (output value) to be displayed	float32	26e2	9954	Same as VirtualChannel.25.Main.PV
VirtualChannel.25.Trend.SpanLow	Specifies the lowest PV (output value) to be displayed	float32	26e1	9953	Same as VirtualChannel.25.Main.PV
VirtualChannel.26.Main.Descriptor	Virtual Channel descriptor	string_t	4d44	19876	Not applicable

Parameter path	Description	Type	Hex	Dec	Resolution
VirtualChannel.26.Main.HighCutOff	The highest input value that will be totalised/counted	float32	2605	9733	Set by VirtualChannel.26.Main.Resolution
VirtualChannel.26.Main.Input1	Input 1 value	float32	2607	9735	Set by VirtualChannel.26.Main.Resolution
VirtualChannel.26.Main.Input2	Input 2 value	float32	2608	9736	Set by VirtualChannel.26.Main.Resolution
VirtualChannel.26.Main.LowCutOff	The lowest input value that will be totalised/counted	float32	2604	9732	Set by VirtualChannel.26.Main.Resolution
VirtualChannel.26.Main.ModbusInput	Modbus input value	float32	2606	9734	Set by VirtualChannel.26.Main.Resolution
VirtualChannel.26.Main.Operation	Specifies the operation of the virtual channel	uint8	2601	9729	Not applicable
VirtualChannel.26.Main.Period	The time period over which the calculation is made	int32	260a	9738	Not applicable
VirtualChannel.26.Main.Preset	Initiate preset. 0 = No; 1 = Yes	bool	260c	9740	Not applicable
VirtualChannel.26.Main.PresetValue	Specifies the preset value	float32	260d	9741	Set by VirtualChannel.26.Main.Resolution
VirtualChannel.26.Main.PV	The virtual channel output value	float32	0170	368	Set by VirtualChannel.26.Main.Resolution
VirtualChannel.26.Main.Reset	Initiate reset. 0 = No; 1 = Yes	bool	260b	9739	Not applicable
VirtualChannel.26.Main.Resolution	Specifies the resolution/number of decimal places	uint8	2602	9730	Not applicable
VirtualChannel.26.Main.Rollover	A pulse signal to indicate PV (output) has just rolled over	bool	2611	9745	Not applicable
VirtualChannel.26.Main.RolloverValue	Rollover value	float32	2612	9746	Set by VirtualChannel.26.Main.Resolution
VirtualChannel.26.Main.Status	As VirtualChannel1.Main.Status	uint8	0171	369	Not applicable
VirtualChannel.26.Main.TimeRemaining	Time remaining before the calculation is made	time_t	2609	9737	Set by Network.Modbus.TimeFormat
VirtualChannel.26.Main.Trigger	Increment/decrement counter. 0 = No; 1 = Yes	bool	260e	9742	Not applicable
VirtualChannel.26.Main.Type	As VirtualChannel1.Main.Type	uint8	2600	9728	Not applicable
VirtualChannel.26.Main.Units	Units descriptor	string_t	4db9	19897	Not applicable
VirtualChannel.26.Main.UnitsScaler	Units scaler for totalisers	float32	2603	9731	1dp
VirtualChannel.26.Trend.Colour	As VirtualChannel1.Trend.Colour	uint8	2720	10016	Not applicable
VirtualChannel.26.Trend.SpanHigh	Specifies the highest PV (output value) to be displayed	float32	2722	10018	Same as VirtualChannel.26.Main.PV
VirtualChannel.26.Trend.SpanLow	Specifies the lowest PV (output value) to be displayed	float32	2721	10017	Same as VirtualChannel.26.Main.PV
VirtualChannel.27.Main.Descriptor	Virtual Channel descriptor	string_t	4dbf	19903	Not applicable
VirtualChannel.27.Main.Disable	1 = Virtual channel disabled	bool	2763	10083	Not applicable
VirtualChannel.27.Main.HighCutOff	The highest input value that will be totalised/counted	float32	2645	9797	Set by VirtualChannel.27.Main.Resolution
VirtualChannel.27.Main.Input1	Input 1 value	float32	2647	9799	Set by VirtualChannel.27.Main.Resolution
VirtualChannel.27.Main.Input2	Input 2 value	float32	2648	9800	Set by VirtualChannel.27.Main.Resolution
VirtualChannel.27.Main.LowCutOff	The lowest input value that will be totalised/counted	float32	2644	9796	Set by VirtualChannel.27.Main.Resolution
VirtualChannel.27.Main.ModbusInput	Modbus input value	float32	2646	9798	Set by VirtualChannel.27.Main.Resolution
VirtualChannel.27.Main.Operation	Specifies the operation of the virtual channel	uint8	2641	9793	Not applicable
VirtualChannel.27.Main.Period	The time period over which the calculation is made	int32	264a	9802	Not applicable
VirtualChannel.27.Main.Preset	Initiate preset. 0 = No; 1 = Yes	bool	264c	9804	Not applicable
VirtualChannel.27.Main.PresetValue	Specifies the preset value	float32	264d	9805	Set by VirtualChannel.27.Main.Resolution
VirtualChannel.27.Main.PV	The virtual channel output value	float32	0172	370	Set by VirtualChannel.27.Main.Resolution
VirtualChannel.27.Main.Reset	Initiate reset. 0 = No; 1 = Yes	bool	264b	9803	Not applicable
VirtualChannel.27.Main.Resolution	Specifies the resolution/number of decimal places	uint8	2642	9794	Not applicable
VirtualChannel.27.Main.Rollover	A pulse signal to indicate PV (output) has just rolled over	bool	2651	9809	Not applicable
VirtualChannel.27.Main.RolloverValue	Rollover value	float32	2652	9810	Set by VirtualChannel.27.Main.Resolution
VirtualChannel.27.Main.Status	As VirtualChannel1.Main.Status	uint8	0173	371	Not applicable
VirtualChannel.27.Main.TimeRemaining	Time remaining before the calculation is made	time_t	2649	9801	Set by Network.Modbus.TimeFormat
VirtualChannel.27.Main.Trigger	Increment/decrement counter. 0 = No; 1 = Yes	bool	264e	9806	Not applicable
VirtualChannel.27.Main.Type	As VirtualChannel1.Main.Type	uint8	2640	9792	Not applicable
VirtualChannel.27.Main.Units	Units descriptor	string_t	4dd4	19924	Not applicable
VirtualChannel.27.Main.UnitsScaler	Units scaler for totalisers	float32	2643	9795	1dp
VirtualChannel.27.Trend.Colour	As VirtualChannel1.Trend.Colour	uint8	2760	10080	Not applicable
VirtualChannel.27.Trend.SpanHigh	Specifies the highest PV (output value) to be displayed	float32	2762	10082	Same as VirtualChannel.27.Main.PV
VirtualChannel.27.Trend.SpanLow	Specifies the lowest PV (output value) to be displayed	float32	2761	10081	Same as VirtualChannel.27.Main.PV
VirtualChannel.28.Main.Descriptor	Virtual Channel descriptor	string_t	4dda	19930	Not applicable
VirtualChannel.28.Main.Disable	1 = Virtual channel disabled	bool	27a3	10147	Not applicable
VirtualChannel.28.Main.HighCutOff	The highest input value that will be totalised/counted	float32	2685	9861	Set by VirtualChannel.28.Main.Resolution
VirtualChannel.28.Main.Input1	Input 1 value	float32	2687	9863	Set by VirtualChannel.28.Main.Resolution
VirtualChannel.28.Main.Input2	Input 2 value	float32	2688	9864	Set by VirtualChannel.28.Main.Resolution
VirtualChannel.28.Main.LowCutOff	The lowest input value that will be totalised/counted	float32	2684	9860	Set by VirtualChannel.28.Main.Resolution
VirtualChannel.28.Main.ModbusInput	Modbus input value	float32	2686	9862	Set by VirtualChannel.28.Main.Resolution
VirtualChannel.28.Main.Operation	Specifies the operation of the virtual channel	uint8	2681	9857	Not applicable
VirtualChannel.28.Main.Period	The time period over which the calculation is made	int32	268a	9866	Not applicable
VirtualChannel.28.Main.Preset	Initiate preset. 0 = No; 1 = Yes	bool	268c	9868	Not applicable
VirtualChannel.28.Main.PresetValue	Specifies the preset value	float32	268d	9869	Set by VirtualChannel.28.Main.Resolution

Parameter path	Description	Type	Hex	Dec	Resolution
VirtualChannel.28.Main.Reset	Initiate reset. 0 = No; 1 = Yes	bool	268b	9867	Not applicable
VirtualChannel.28.Main.Resolution	Specifies the resolution/number of decimal places	uint8	2682	9858	Not applicable
VirtualChannel.28.Main.Rollover	A pulse signal to indicate PV (output) has just rolled over	bool	2691	9873	Not applicable
VirtualChannel.28.Main.RolloverValue	Rollover value	float32	2692	9874	Set by VirtualChannel.28.Main.Resolution
VirtualChannel.28.Main.Status	As VirtualChannel1.Main.Status	uint8	0175	373	Not applicable
VirtualChannel.28.Main.TimeRemaining	Time remaining before the calculation is made	time_t	2689	9865	Set by Network.Modbus.TimeFormat
VirtualChannel.28.Main.Trigger	Increment/decrement counter. 0 = No; 1 = Yes	bool	268e	9870	Not applicable
VirtualChannel.28.Main.Type	As VirtualChannel1.Main.Type	uint8	2680	9856	Not applicable
VirtualChannel.28.Main.Units	Units descriptor	string_t	4def	19951	Not applicable
VirtualChannel.28.Main.UnitsScaler	Units scaler for totalisers	float32	2683	9859	1dp
VirtualChannel.28.Trend.Colour	As VirtualChannel1.Trend.Colour	uint8	27a0	10144	Not applicable
VirtualChannel.28.Trend.SpanHigh	Specifies the highest PV (output value) to be displayed	float32	27a2	10146	Same as VirtualChannel.28.Main.PV
VirtualChannel.28.Trend.SpanLow	Specifies the lowest PV (output value) to be displayed	float32	27a1	10145	Same as VirtualChannel.28.Main.PV
VirtualChannel.29.Main.Descriptor	Virtual Channel descriptor	string_t	4df5	19957	Not applicable
VirtualChannel.29.Main.Disable	1 = Virtual channel disabled	bool	27e3	10211	Not applicable
VirtualChannel.29.Main.HighCutOff	The highest input value that will be totalised/counted	float32	26c5	9925	Set by VirtualChannel.29.Main.Resolution
VirtualChannel.29.Main.Input1	Input 1 value	float32	26c7	9927	Set by VirtualChannel.29.Main.Resolution
VirtualChannel.29.Main.Input2	Input 2 value	float32	26c8	9928	Set by VirtualChannel.29.Main.Resolution
VirtualChannel.29.Main.LowCutOff	The lowest input value that will be totalised/counted	float32	26c4	9924	Set by VirtualChannel.29.Main.Resolution
VirtualChannel.29.Main.ModbusInput	Modbus input value	float32	26c6	9926	Set by VirtualChannel.29.Main.Resolution
VirtualChannel.29.Main.Operation	Specifies the operation of the virtual channel	uint8	26c1	9921	Not applicable
VirtualChannel.29.Main.Period	The time period over which the calculation is made	int32	26ca	9930	Not applicable
VirtualChannel.29.Main.Preset	Initiate preset. 0 = No; 1 = Yes	bool	26cc	9932	Not applicable
VirtualChannel.29.Main.PresetValue	Specifies the preset value	float32	26cd	9933	Set by VirtualChannel.29.Main.Resolution
VirtualChannel.29.Main.PV	The virtual channel output value	float32	0176	374	Set by VirtualChannel.29.Main.Resolution
VirtualChannel.29.Main.Reset	Initiate reset. 0 = No; 1 = Yes	bool	26cb	9931	Not applicable
VirtualChannel.29.Main.Resolution	Specifies the resolution/number of decimal places	uint8	26c2	9922	Not applicable
VirtualChannel.29.Main.Rollover	A pulse signal to indicate PV (output) has just rolled over	bool	26d1	9937	Not applicable
VirtualChannel.29.Main.RolloverValue	Rollover value	float32	26d2	9938	Set by VirtualChannel.29.Main.Resolution
VirtualChannel.29.Main.Status	As VirtualChannel1.Main.Status	uint8	0177	375	Not applicable
VirtualChannel.29.Main.TimeRemaining	Time remaining before the calculation is made	time_t	26c9	9929	Set by Network.Modbus.TimeFormat
VirtualChannel.29.Main.Trigger	Increment/decrement counter. 0 = No; 1 = Yes	bool	26ce	9934	Not applicable
VirtualChannel.29.Main.Type	As VirtualChannel1.Main.Type	uint8	26c0	9920	Not applicable
VirtualChannel.29.Main.Units	Units descriptor	string_t	4e0a	19978	Not applicable
VirtualChannel.29.Main.UnitsScaler	Units scaler for totalisers	float32	26c3	9923	1dp
VirtualChannel.29.Trend.Colour	As VirtualChannel1.Trend.Colour	uint8	27e0	10208	Not applicable
VirtualChannel.29.Trend.SpanHigh	Specifies the highest PV (output value) to be displayed	float32	27e2	10210	Same as VirtualChannel.29.Main.PV
VirtualChannel.29.Trend.SpanLow	Specifies the lowest PV (output value) to be displayed	float32	27e1	10209	Same as VirtualChannel.29.Main.PV
VirtualChannel.30.Main.Descriptor	Virtual Channel descriptor	string_t	4e10	19984	Not applicable
VirtualChannel.30.Main.Disable	1 = Virtual channel disabled	bool	2823	10275	Not applicable
VirtualChannel.30.Main.HighCutOff	The highest input value that will be totalised/counted	float32	2705	9989	Set by VirtualChannel.30.Main.Resolution
VirtualChannel.30.Main.Input1	Input 1 value	float32	2707	9991	Set by VirtualChannel.30.Main.Resolution
VirtualChannel.30.Main.Input2	Input 2 value	float32	2708	9992	Set by VirtualChannel.30.Main.Resolution
VirtualChannel.30.Main.LowCutOff	The lowest input value that will be totalised/counted	float32	2704	9988	Set by VirtualChannel.30.Main.Resolution
VirtualChannel.30.Main.ModbusInput	Modbus input value	float32	2706	9990	Set by VirtualChannel.30.Main.Resolution
VirtualChannel.30.Main.Operation	Specifies the operation of the virtual channel	uint8	2701	9985	Not applicable
VirtualChannel.30.Main.Period	The time period over which the calculation is made	int32	270a	9994	Not applicable
VirtualChannel.30.Main.Preset	Initiate preset. 0 = No; 1 = Yes	bool	270c	9996	Not applicable
VirtualChannel.30.Main.PresetValue	Specifies the preset value	float32	270d	9997	Set by VirtualChannel.30.Main.Resolution
VirtualChannel.30.Main.PV	The virtual channel output value	float32	0178	376	Set by VirtualChannel.30.Main.Resolution
VirtualChannel.30.Main.Reset	Initiate reset. 0 = No; 1 = Yes	bool	270b	9995	Not applicable
VirtualChannel.30.Main.Resolution	Specifies the resolution/number of decimal places	uint8	2702	9986	Not applicable
VirtualChannel.30.Main.Rollover	A pulse signal to indicate PV (output) has just rolled over	bool	2711	10001	Not applicable
VirtualChannel.30.Main.RolloverValue	Rollover value	float32	2712	10002	Set by VirtualChannel.30.Main.Resolution
VirtualChannel.30.Main.Status	As VirtualChannel1.Main.Status	uint8	0179	377	Not applicable
VirtualChannel.30.Main.TimeRemaining	Time remaining before the calculation is made	time_t	2709	9993	Set by Network.Modbus.TimeFormat
VirtualChannel.30.Main.Trigger	Increment/decrement counter. 0 = No; 1 = Yes	bool	270e	9998	Not applicable
VirtualChannel.30.Main.Type	As VirtualChannel1.Main.Type	uint8	2700	9984	Not applicable
VirtualChannel.30.Main.Units	Units descriptor	string_t	4e25	20005	Not applicable
VirtualChannel.30.Main.UnitsScaler	Units scaler for totalisers	float32	2703	9987	1dp

Parameter path	Description	Type	Hex	Dec	Resolution
VirtualChannel.30.Trend.SpanHigh	Specifies the highest PV (output value) to be displayed	float32	2822	10274	Same as VirtualChannel.30.Main.PV
VirtualChannel.30.Trend.SpanLow	Specifies the lowest PV (output value) to be displayed	float32	2821	10273	Same as VirtualChannel.30.Main.PV
WebServer.Status	Status	uint8	3044	12356	Not applicable
WebServer.Enabled	Enabled	uint8	3045	12357	Not applicable
WebServer.Port	Port	uint8	3046	12358	Not applicable
WebServer.Security	Security	uint8	3047	12359	Not applicable
WebServer.Username	Username	string_t	776f	30575	Not applicable
WebServer.Password	Password	string_t	77d4	30676	Not applicable
Zirconia.aC_CO_O2	Carbon Activity Between CO and O2	float32	289e	10398	4dp
Zirconia.BalanceIntegral	Balance Integral	bool	289d	10397	Not applicable
Zirconia.CarbonPot	Calculated Carbon Potential	float32	2892	10386	Set by Zirconia.Resolution
Zirconia.Clean.AbortClean	1 = Abort cleaning process	bool	28b5	10421	Not applicable
Zirconia.Clean.CantClean	1 = can't clean	bool	28c3	10435	Not applicable
Zirconia.Clean.CleanAbort	1 = Cleaning cycle has been aborted	bool	28c4	10436	Not applicable
Zirconia.Clean.CleanEnable	1 = probe cleaning allowed	bool	28b2	10418	Not applicable
Zirconia.Clean.CleanFreq	Interval between probe cleaning cycles	time_t	28aa	10410	Set by Network.Modbus.TimeFormat
Zirconia.Clean.CleanMaxTemp	Maximum temperature for cleaning. If, during the cleaning cycle, the probe temperature exceeds this value, cleaning is aborted.	float32	28b4	10420	0dp
Zirconia.Clean.CleanMsgReset	1 = Clear cleaning related alarms	bool	28b3	10419	Not applicable
Zirconia.Clean.CleanProbe	1 = Initiate a probe cleaning cycle	bool	28b0	10416	Not applicable
Zirconia.Clean.CleanRecoveryTime	The time taken to recover from last clean. 0 = max. clean recovery time exceeded last time	time_t	28b6	10422	Set by Network.Modbus.TimeFormat
Zirconia.Clean.CleanTemp	1 = Clean cycle aborted because cleaning temperature was too high.	bool	28c5	10437	Not applicable
Zirconia.Clean.CleanTime	The time for which the probe is cleaned	time_t	28ab	10411	Set by Network.Modbus.TimeFormat
Zirconia.Clean.CleanValve	1 = Enable probe cleaning valve	bool	28af	10415	Not applicable
Zirconia.Clean.LastCleanMv	Probe output after last clean, in mV	float32	28b7	10423	0dp
Zirconia.Clean.MaxRcovTime	Max. recovery time after a purge	time_t	28ad	10413	Set by Network.Modbus.TimeFormat
Zirconia.Clean.MinRcovTime	Min. recovery time after a purge	time_t	28ac	10412	Set by Network.Modbus.TimeFormat
Zirconia.Clean.ProbeFault	1 = Probe failed to recover following the clean cycle	bool	28ae	10414	Not applicable
Zirconia.Clean.Time2Clean	Time to next cleaning cycle	time_t	28b1	10417	Set by Network.Modbus.TimeFormat
Zirconia.CleanFreq	Interval between cleaning cycles	time_t	2889	10377	Set by Network.Modbus.TimeFormat
Zirconia.CleanProbe	Initiates a demand cleaning cycle	bool	289a	10394	Not applicable
Zirconia.CleanState	Cleaning State (0 = Waiting, 1 = Cleaning, 2 = Recovering)	uint8	2899	10393	Not applicable
Zirconia.CleanTime	The time for which the probe is cleaned	time_t	288a	10378	Set by Network.Modbus.TimeFormat
Zirconia.CleanValve	1 = Enable probe cleaning valve	bool	2898	10392	Not applicable
Zirconia.DewPoint	Calculated Dewpoint	float32	2893	10387	Set by Zirconia.Resolution
Zirconia.GasRef	Reference value for hydrogen concentration	float32	2882	10370	1dp
Zirconia.GasRefs.CO_Ideal	Gas ref value when Oxygen Type = Nernst	float32	28a9	10409	1dp
Zirconia.GasRefs.CO_InUse	The CO gas measurement value being used	float32	28a4	10404	1dp
Zirconia.GasRefs.CO_Local	Reference value for CO concentration	float32	28a1	10401	1dp
Zirconia.GasRefs.CO_Remote	CO concentration from remote source	float32	28a2	10402	1dp
Zirconia.GasRefs.CO_RemoteEn	1 = Allow remote gas measurement	bool	28a3	10403	Not applicable
Zirconia.GasRefs.H2_InUse	The hydrogen gas measurement value being used	float32	28a8	10408	1dp
Zirconia.GasRefs.H2_Local	Reference value for hydrogen concentration	float32	28a5	10405	1dp
Zirconia.GasRefs.H2_Remote	Hydrogen concentration from remote source	float32	28a6	10406	1dp
Zirconia.GasRefs.H2_RemoteEn	1 = Allow remote gas measurement	bool	28a7	10407	Not applicable
Zirconia.MaxRcovTime	Maximum recovery time after a purge	time_t	288c	10380	Set by Network.Modbus.TimeFormat
Zirconia.MinCalTemp	Min. temp at which the calculation is valid	float32	2886	10374	Same as Zirconia.Templnput
Zirconia.MinRcovTime	Minimum recovery time after a purge	time_t	288b	10379	Set by Network.Modbus.TimeFormat
Zirconia.NumResolution	Number of decimal places	uint8	2881	10369	Not applicable
Zirconia.Oxygen	Calculated Oxygen value	float32	2894	10388	Set by Zirconia.Resolution
Zirconia.OxygenExp	Exponent used by log oxygen calculations	int16	288d	10381	Not applicable
Zirconia.OxygenType	The oxygen equation being used. 0 = Nernst 1=Nernst Bosch 2 = Nernst CP 3= Ferronova	uint8	28a0	10400	Not applicable
Zirconia.ProbeFault	Probe Clean Recovery Warning	bool	2896	10390	Not applicable
Zirconia.ProbeInput	Probe input in mV	float32	2890	10384	0dp
Zirconia.ProbeOffset	Probe offset in mV	float32	2891	10385	Set by Zirconia.Resolution
Zirconia.ProbeState	State of the probe measurement system	uint8	289f	10399	Not applicable

Parameter path	Description	Type	Hex	Dec	Resolution
Zirconia.ProbeStatus	0 = Measuring 1 = Cleaning 2 = Clean Recovery 3 = Test impedance 4 = Impedance recovery 5 = Not ready Status of Probe	uint8	289c	10396	Not applicable
Zirconia.ProbeType	0 = OK 1 = mVSbr 2 = TempSbr 3 = MincalcT Type of Probe 25 = MMI 26 = AACC 27 = Dray 28 = Accu 29 = SSI 30 = MacD 31 = Bosch 32 = Barber 33 = ferono 34 = PrbmV 35 = Eurotherm	uint8	2880	10368	Not applicable
Zirconia.ProcFactor	Process Factor (Value defined by probe manufacturer)	float32	2888	10376	1dp
Zirconia.PVFrozen	1 = PV frozen	bool	2897	10391	Not applicable
Zirconia.RemGasEn	1 = Enable use of remote gas reference	bool	2884	10372	Not applicable
Zirconia.RemGasRef	Remote Gas Reference Value	float32	2883	10371	1dp
Zirconia.SootAlm	1 = Soot alarm active	bool	2895	10389	Not applicable
Zirconia.TempInput	Probe temperature Input	float32	288e	10382	0dp
Zirconia.TempOffset	Temperature Offset	float32	288f	10383	Set by Zirconia.Resolution
Zirconia.Time2Clean	Time To Next Clean	time_t	289b	10395	Set by Network.Modbus.TimeFormat
Zirconia.Tolerance	Sooting Tolerance	float32	2887	10375	1dp
Zirconia.WrkGas	Working Reference Gas Value	float32	2885	10373	1dp

BACnet

BACnet Objects

In BACnet, objects are collections of properties, each representing some bit of information. In addition to standard defined properties, objects may include vendor-defined properties as long as they function in accordance with the standard. BACnet also defines the expected behaviour from each property for that object. What makes the object-oriented approach work is that every object and every property as defined by the system is accessible in exactly the same manner. See Section "BACnet Object Mapping" on page 343 for further details.

BACnet Services

The process of reading or writing to a property is what BACnet calls a service. Services are the methods used by any BACnet device when it communicates with another BACnet device, including retrieving information, transmitting information or communicating an action. The standard defines a wide range of services for accessing objects and their properties. See Section "BACnet Services" on page 347 for further details.

BACnet Object Mapping

Mapping to I/O and Loop Data Points

BACnet objects are mapped to nanodac I/O and Loop data points as shown in Table 2.

Object types are denoted in the table as follows:

AI – Analogue Input

AV – Analogue Value

BI – Binary Input

BV – Binary Value

CS – Character String

MSI – Multi State Input

Input channels 5-8 are instantiated as BACnet objects if the 'Dual Input Channels' option is set to '05..08'.

Table 2: BACnet Object Representation of I/O and Loops

Object Name		Type	Data Parameter	Equivalent Modbus Path	R/W
Input Channel 1	Channel.1.Main.PV	AI	PV	Channel.1.Main.PV	R
			PV Status	Channel.1.Main.Status	
	Channel.1.Alarm1.Threshold	AV	AL1 Threshold	Channel.1.Alarm1.Threshold	R/W
	Channel.1.Alarm1.Status	MSI	AL1 Status	Channel.1.Alarm1.Status	R
	Channel.1.Alarm2.Threshold	AV	AL2 Threshold	Channel.1.Alarm2.Threshold	R/W
Channel.1.Alarm2.Status	MSI	AL2 Status	Channel.1.Alarm2.Status	R	

Object Name		Type	Data Parameter	Equivalent Modbus Path	R/W
Input Channel 2	Channel.2.Main.PV	AI	PV	Channel.2.Main.PV	R
			PV Status	Channel.2.Main.Status	
	Channel.2.Alarm1.Threshold	AV	AL1 Threshold	Channel.2.Alarm1.Threshold	R/W
	Channel.2.Alarm1.Status	MSI	AL1 Status	Channel.2.Alarm1.Status	R
	Channel.2.Alarm2.Threshold	AV	AL2 Threshold	Channel.2.Alarm2.Threshold	R/W
	Channel.2.Alarm2.Status	MSI	AL2 Status	Channel.2.Alarm2.Status	R
Input Channel 3	Channel.3.Main.PV	AI	PV	Channel.3.Main.PV	R
			PV Status	Channel.3.Main.Status	
	Channel.3.Alarm1.Threshold	AV	AL1 Threshold	Channel.3.Alarm1.Threshold	R/W
	Channel.3.Alarm1.Status	MSI	AL1 Status	Channel.3.Alarm1.Status	R
	Channel.3.Alarm2.Threshold	AV	AL2 Threshold	Channel.3.Alarm2.Threshold	R/W
	Channel.3.Alarm2.Status	MSI	AL2 Status	Channel.3.Alarm2.Status	R
Input Channel 4	Channel.4.Main.PV	AI	PV	Channel.4.Main.PV	R
			PV Status	Channel.4.Main.Status	
	Channel.4.Alarm1.Threshold	AV	AL1 Threshold	Channel.4.Alarm1.Threshold	R/W
	Channel.4.Alarm1.Status	MSI	AL1 Status	Channel.4.Alarm1.Status	R
	Channel.4.Alarm2.Threshold	AV	AL2 Threshold	Channel.4.Alarm2.Threshold	R/W
	Channel.4.Alarm2.Status	MSI	AL2 Status	Channel.4.Alarm2.Status	R
Input Channel 5-8	<i>Instantiated similar to above (if required)</i>				
Loop 1	Loop.1.Main.PV	AV	Process Variable	Loop.1.Main.PV	R/W
	Loop.1.Main.TargetSP	AV	Target SP	Loop.1.Main.TargetSP	R/W
	Loop.1.Main.WorkingSP	AI	Working SP	Loop.1.Main.WorkingSP	R
	Loop.1.Main.ActiveOut	AI	Working OP	Loop.1.Main.ActiveOut	R
	Loop.1.Main.AutoMan	AV	Auto/Manual	Loop.1.Main.AutoMan	R/W
	Loop.1.OP.ManualOutVal	AV	Manual OP Value	Loop.1.OP.ManualOutVal	R/W
	Loop.1.PID.ProportionalBand	AV	Proportional Value	Loop.1.PID.ProportionalBand	R/W
	Loop.1.PID.IntegralTime	AV	Integral Value	Loop.1.PID.IntegralTime	R/W
	Loop.1.PID.DerivativeTime	AV	Derivative Value	Loop.1.PID.DerivativeTime	R/W
	Loop.1.Setup.LoopName	CS	Loop Name	Loop.1.Setup.LoopName	R
Loop 2	Loop.2.Main.PV	AV	Process Variable	Loop.2.Main.PV	R/W
	Loop.2.Main.TargetSP	AV	Target SP	Loop.2.Main.TargetSP	R/W
	Loop.2.Main.WorkingSP	AI	Working SP	Loop.2.Main.WorkingSP	R
	Loop.2.Main.ActiveOut	AI	Working OP	Loop.2.Main.ActiveOut	R
	Loop.2.Main.AutoMan	AV	Auto/Manual	Loop.2.Main.AutoMan	R/W
	Loop.2.OP.ManualOutVal	AV	Manual OP Value	Loop.2.OP.ManualOutVal	R/W
	Loop.2.PID.ProportionalBand	AV	Proportional Value	Loop.2.PID.ProportionalBand	R/W
	Loop.2.PID.IntegralTime	AV	Integral Value	Loop.2.PID.IntegralTime	R/W
	Loop.2.PID.DerivativeTime	AV	Derivative Value	Loop.2.PID.DerivativeTime	R/W
	Loop.2.Setup.LoopName	CS	Loop Name	Loop.2.Setup.LoopName	R

Object Name		Type	Data Parameter	Equivalent Modbus Path	R/W
Steam Tables	Steam.1.HeatFlow	AI	HeatFlow	Steam.1.HeatFlow	R
	Steam.1.MassFlow	AI	MassFlow	Steam.1.MassFlow	R
	Steam.1.HeatConsumed	AI	HeatConsumed	Steam.1.HeatConsumed	R
	Steam.2.WaterEnth	AI	WaterEnth	Steam.2.WaterEnth	R
	Steam.2.SteamEnth	AI	SteamEnth	Steam.2.SteamEnth	R
	Steam.2.CalcValue	AI	CalcValue	Steam.2.CalcValue	R
Digital I/O	DigitalIO.DI_LALC.Output	BI	Dig In A	DigitalIO.DI_LALC.Output	R
	DigitalIO.DI_LBLC.Output	BI	Dig In B	DigitalIO.DI_LBLC.Output	R
	DigitalIO.1A1B.Output	BI	I/O 1 - Output	DigitalIO.1A1B.Output	R
	DigitalIO.1A1B.PV	AI	I/O 1 - Input	DigitalIO.1A1B.PV	R
	DigitalIO.2A2B.Output	BI	I/O 2 - Output	DigitalIO.2A2B.Output	R
	DigitalIO.2A2B.PV	AI	I/O 2 - Input	DigitalIO.2A2B.PV	R
	DigitalIO.3A3B.Output	BI	I/O 3 - Output	DigitalIO.3A3B.Output	R
	DigitalIO.3A3B.PV	AI	I/O 3 - Input	DigitalIO.3A3B.PV	R
	DigitalIO.RELAY_4AC.Output	BI	Relay Out 4	DigitalIO.RELAY_4AC.Output	R
	DigitalIO.RELAY_5AC.Output	BI	Relay Out 5	DigitalIO.RELAY_5AC.Output	R

Mapping to Virtual Channels

BACnet objects are mapped to nanodac virtual channels as shown in Table 3. A maximum of 30 virtual channel objects are supported.

Table 3: BACnet Object Representation of Virtual Channels

Object Name	Type	Data Parameter	Equivalent Modbus Path	R/W
Virtual Channel (n, m)	AI	PV	VirtualChannel.n.Main.PV	R
		PV Status	VirtualChannel.n.Main.Sta tus	
	AV	AL1 Threshold	VirtualChannel.n.Alarm1.T hreshold	R/W
	MSI	AL1 Status	VirtualChannel.n.Alarm1.S tatus	R
	AV	AL2 Threshold	VirtualChannel.n.Alarm2.T hreshold	R/W
MSI	AL2 Status	VirtualChannel.n.Alarm2.S tatus	R	

Read/Write Access to Internal Modbus Registers

Read/write access to any internal Modbus register is provided using pairs of BACnet objects named 'User Parameters' as shown in Table 4.

30 User Parameter pairs (numbered 1 to 30) are supported.

Table 4: Modbus Register Access

Object Name	Type	Data Parameter	Internal Path	R/W
UserParameter.n.Address	AV	R/W User Parameter <i>n</i>	VirtualChannel.n.Alarm1.Threshold	R/W
UserParameter.n.Value	AV		VirtualChannel.n.Alarm1.Status	R/W

This functionality allows the BACnet user to access any internal parameter that is available in the standard Modbus address space. Pairs of values as shown in Table 4 are implemented as two BACnet Analog Value objects. The BACnet client (typically a BMS) will write the first value with the Modbus address for the data parameter required as shown in Figure 162. The user may obtain the Modbus address from "Parameter List" on page 232 of this manual.



Figure 162 BMS Client writes address of required parameter

The BMS client may then read or write to the data referenced by this address, as shown in Figure 163.



Figure 163 BMS Client reads/writes to data parameter

Note: The data value will always be represented over BACnet as a floating point, even if the internal source data is of a different type (e.g. Bool). Strings will not be accessible using this mechanism.

Note: Values written to device parameters via BACnet may be overwritten (with different values) internally by the device firmware under certain device configurations. Due to this, when the values of the BACnet objects are read back, they may be different to the value requested via the preceding BACnet write command.

Optional parameters

The following optional parameters shall be implemented in addition to the standard required parameters for all relevant object types:

Table 5: Optional Parameters

Property	R/W	Description
Description	R	Alphanumeric description of channel function, eg "Furnace 1".
Device_Type	Rr	Alphanumeric description of Input type for the channel eg 'Off', 'Thermocouple', 'mV'

BACnet Services

Services required by the BACnet Application Specific Controller Profile (B-ASC) are supported, as detailed in the following table:

Table 6: Services Required by B-ASC Profile

Application Service	Description	Service Type
ReadProperty	Request the value of one property of a BACnet object	Object Access
WriteProperty	Modify value of a single property (if permitted)	Object Access
DeviceCommunicationControl	Allows an operator to take device communications on or off-line. With support for password.	Remote Device Management
Who-Is	Asks about the presence of specified BACnet devices	Remote Device Management
Who-Has	Asks about the presence of specified Objects either by type and instance or by name	Remote Device Management

Foreign Device Registration

A 'foreign device' has a different subnet address from the devices on the BACnet/IP network that it wishes to join. The device must register with a BBMD (BACnet Broadcast Management Device) which then forwards broadcast messages allowing full participation in the BACnet/IP network.

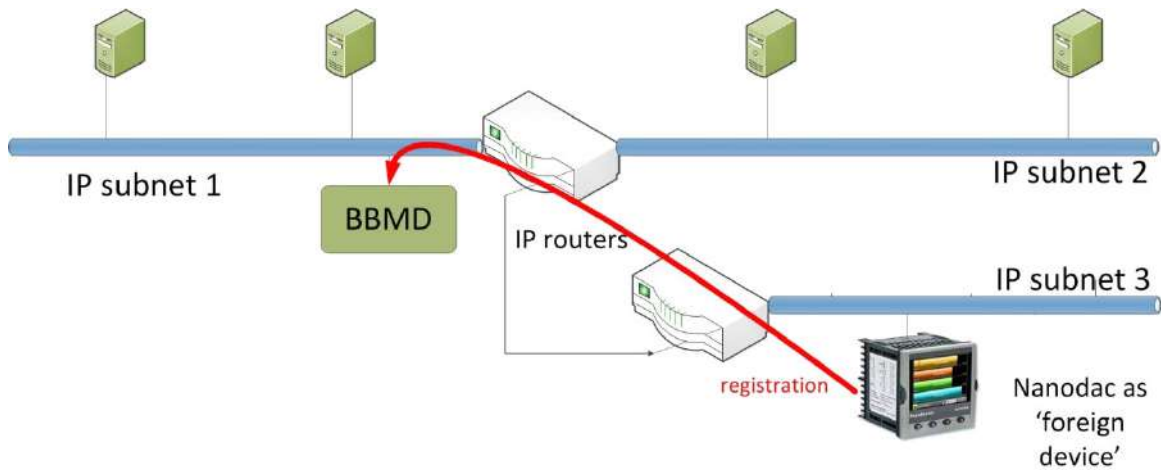

Figure 164 Foreign Device Registration

BACnet Configuration

"BACnet" on page 116 provides details for configuring BACnet on the instrument.

The BACnet parameters described in Section "BACnet Object Mapping" on page 343 can be configured using the iTools software.

iTOOLS

iTools software running on a PC allows quick and easy access to the configuration of the unit. The parameters used are generally the same as those described in "Configuration", with the addition of various diagnostic parameters. iTools also gives the user the ability to create software wiring between function blocks, such wiring being carried out using the Graphical Wiring Editor feature.

Note: nanodac allows for multiple masters to access the device simultaneously. If unauthorized user(s) with malicious intent gain access to the network on which nanodac is operating, they may be able to modify configuration parameters without authorization if the device is already in configuration mode due to an existing authorized user session. To avoid such misuse, it is recommended to configure the device in isolation from other devices in the network. Refer Additionally, refer to Cybersecurity Good Practices Guide, Part Number HA032968 on <https://www.eurotherm.com> which provides an overview of cybersecurity principles to consider.

A further feature - the display mode 'Promote List', is populated using iTools -see "Promote list" on page 77 for details. In addition to the guidance given here, there are two on-line Help systems available within iTools: Parameter help and iTools help. Parameter help is accessed by clicking on 'Help' in the toolbar (opens the complete parameter help system), by right-clicking on a parameter and selecting 'Parameter Help' from the resulting context menu, or by clicking on the Help menu and selecting 'Device Help'. iTools help is accessed by clicking on the Help menu, and selecting 'Contents'. iTools help is also available in manual format under part number HA028838, either as a physical manual or as a PDF file.

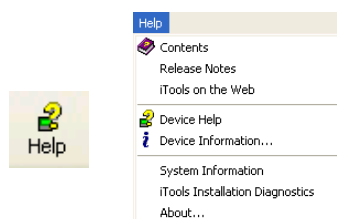

Figure 165 Help access

iTools Connection

The following descriptions assume that iTools software has been correctly installed on the PC.

Ethernet (Modbus TCP) communications

Note: The following description is based on Windows 7.

It is first necessary to determine the IP address of the unit, as described under 'Network.Interface' in "Interface" on page 110. Once the Ethernet link has been correctly installed, carry out the following actions at the PC:

1. Click on 'Start'.
2. Click on 'Control Panel'.
3. Double-click on 'iTools (32-bit)'.
4. Click on the TCP/IP tab in the Registry settings configuration.

6. Type-in a name for the port, then click 'Add...' again.
7. Type the IP address of the unit in the 'Edit Host' box which appears. Click OK.
8. Check the details in the 'New TCP/IP Port' box, then click on 'OK'.
9. Click on 'OK' in the 'Registry settings' box to confirm the new port.

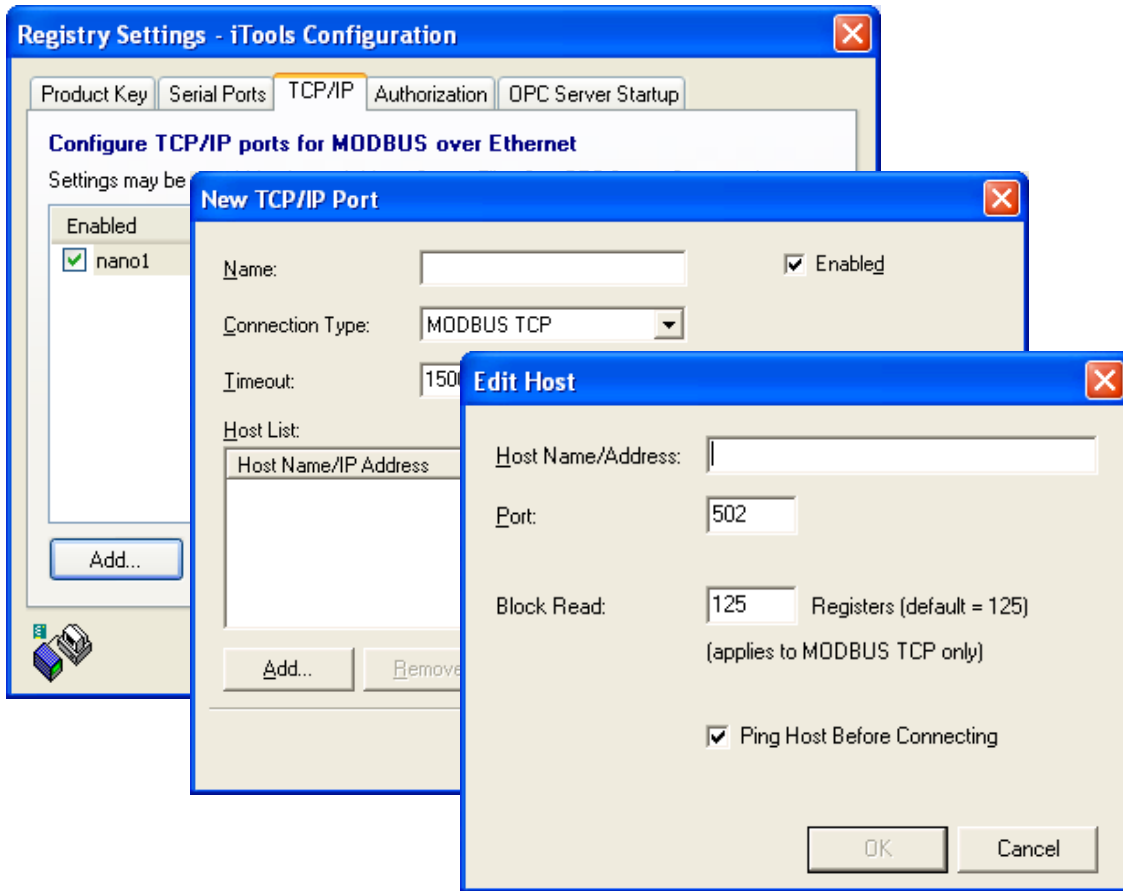
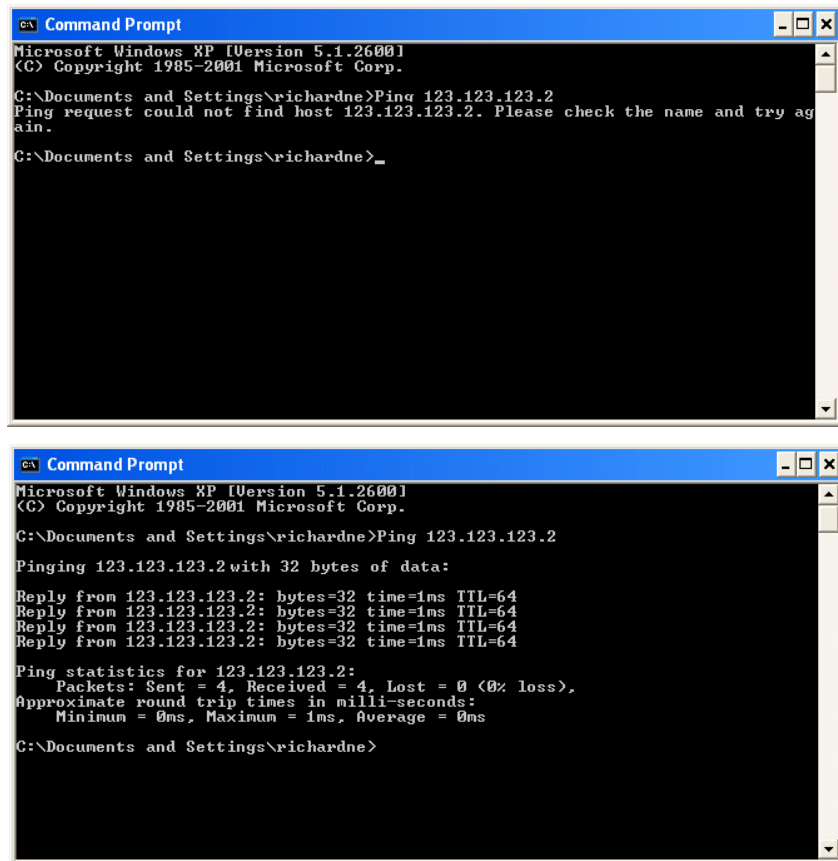

Figure 166 Adding a new Ethernet port

To check that the PC can now communicate with the instrument, Click 'Start'. 'All Programs', 'Accessories',

'Command Prompt' when the Command Prompt box appears, type in:
 Ping<Space>IP1.IP2.IP3.IP4<Enter> (where IP1 to IP4 are the IP address of the instrument).

If the Ethernet link to the instrument is operating correctly, the 'successful' reply arrives. Otherwise, the 'failed' reply arrives, in which case, the Ethernet link, IP address, and PC port details should be verified.



```
Microsoft Windows XP [Version 5.1.2600]
(C) Copyright 1985-2001 Microsoft Corp.

C:\Documents and Settings\richardne>Ping 123.123.123.2
Ping request could not find host 123.123.123.2. Please check the name and try again.

C:\Documents and Settings\richardne>_

Microsoft Windows XP [Version 5.1.2600]
(C) Copyright 1985-2001 Microsoft Corp.

C:\Documents and Settings\richardne>Ping 123.123.123.2
Pinging 123.123.123.2 with 32 bytes of data:

Reply from 123.123.123.2: bytes=32 time=1ms TTL=64
Reply from 123.123.123.2: bytes=32 time=1ms TTL=64
Reply from 123.123.123.2: bytes=32 time=1ms TTL=64
Reply from 123.123.123.2: bytes=32 time=1ms TTL=64

Ping statistics for 123.123.123.2:
    Packets: Sent = 4, Received = 4, Lost = 0 (0% loss),
    Approximate round trip times in milli-seconds:
        Minimum = 0ms, Maximum = 1ms, Average = 0ms

C:\Documents and Settings\richardne>
```

Figure 167 Command prompt 'Ping' screens (typical)

Once the Ethernet link to the instrument has been verified, iTools can be started (or shut down and restarted), and the Scan toolbar icon used, to 'find' the instrument. The scan can be stopped at any time by clicking on the Scan icon a second time.



See Section "Scanning for Instruments" on page 353 for more details of the scan procedure.

Direct Connection

This section describes how to connect a PC directly to the instrument.

Wiring

Connection is made from the Ethernet connector at the rear of the Instrument to an Ethernet RJ45 connector, usually located at the rear of the PC. The cable can be either a 'cross-over' or 'straight through' type.



PC Ethernet connector.

Once wired correctly, and powered up, it is necessary to enter a suitable IP address and subnet mask into the Comms configuration of the Driver Module. This information can be found as follows:

1. At the PC, click 'Start'. 'All Programs', 'Accessories', 'Command Prompt'.
2. When the Command Prompt box appears, type IPConfig and press <Enter>. The response is a display, such as that shown below, giving the IP address and Subnet mask of the PC. Choose an address in the range covered by these two values.

A subnet mask element of 255 means that the equivalent element of the IP address must be used unchanged. A subnet mask element of 0 means that the equivalent element of the IP address may take any value between 1 and 255 (0 is not allowed). In the example below, the range of IP addresses which may be chosen for the Driver Module is 123.123.123.2 to 123.123.123.255. (123.123.123.0 is not allowed and 123.123.123.1 is the same as the PC's address, and may therefore not be used.)

```

CA Command Prompt
Microsoft Windows XP [Version 5.1.2600]
(C) Copyright 1985-2001 Microsoft Corp.

C:\Documents and Settings\richardne>IPConfig

Windows IP Configuration

Ethernet adapter Local Area Connection:

    Connection-specific DNS Suffix . : 
    IP Address . . . . . : 123.123.123.1
    Subnet Mask . . . . . : 255.255.255.0
    Default Gateway . . . . . : 

C:\Documents and Settings\richardne>

```

Figure 168 IP Config command

3. In Network.Interface configuration ("Interface" on page 110) enter the selected IP address and the subnet mask (as it appears in the command prompt window) in the relevant parts of the menu.
4. Check communications by 'pinging' as described in Section "Ethernet (Modbus TCP) communications" on page 349.

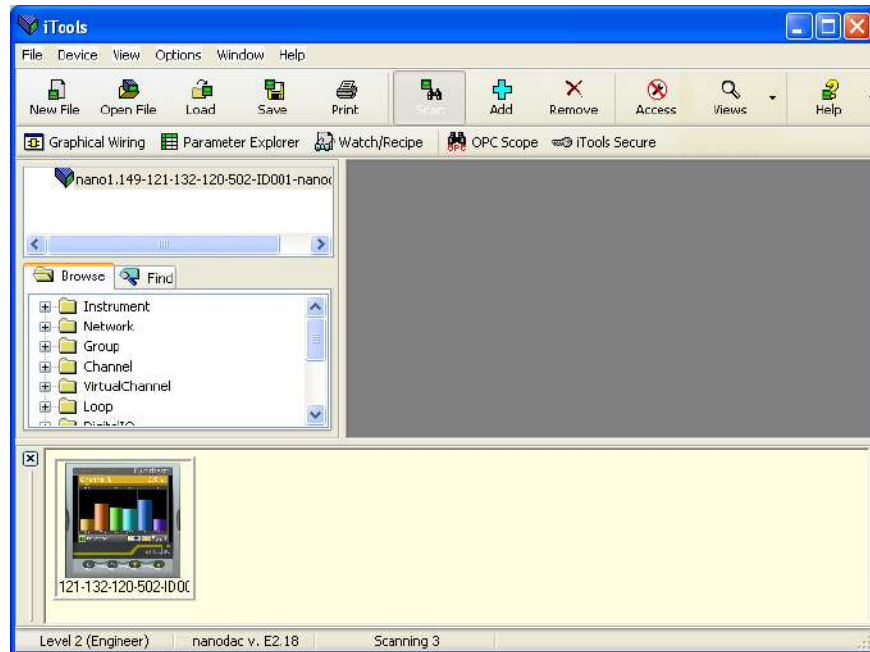

Figure 170 iTools initial window with one instrument detected

Once the instrument has been detected stop the scan. When the instrument has synchronised, click on the 'Access' button to enter configuration mode (a password might be required). Once the editing session is complete, click on the 'Access' button again to quit configuration mode.

Graphical Wiring Editor Graphical Wiring

Clicking on the Graphical Wiring Editor tool bar icon causes the Graphical wiring window for the current instrument configuration to open.

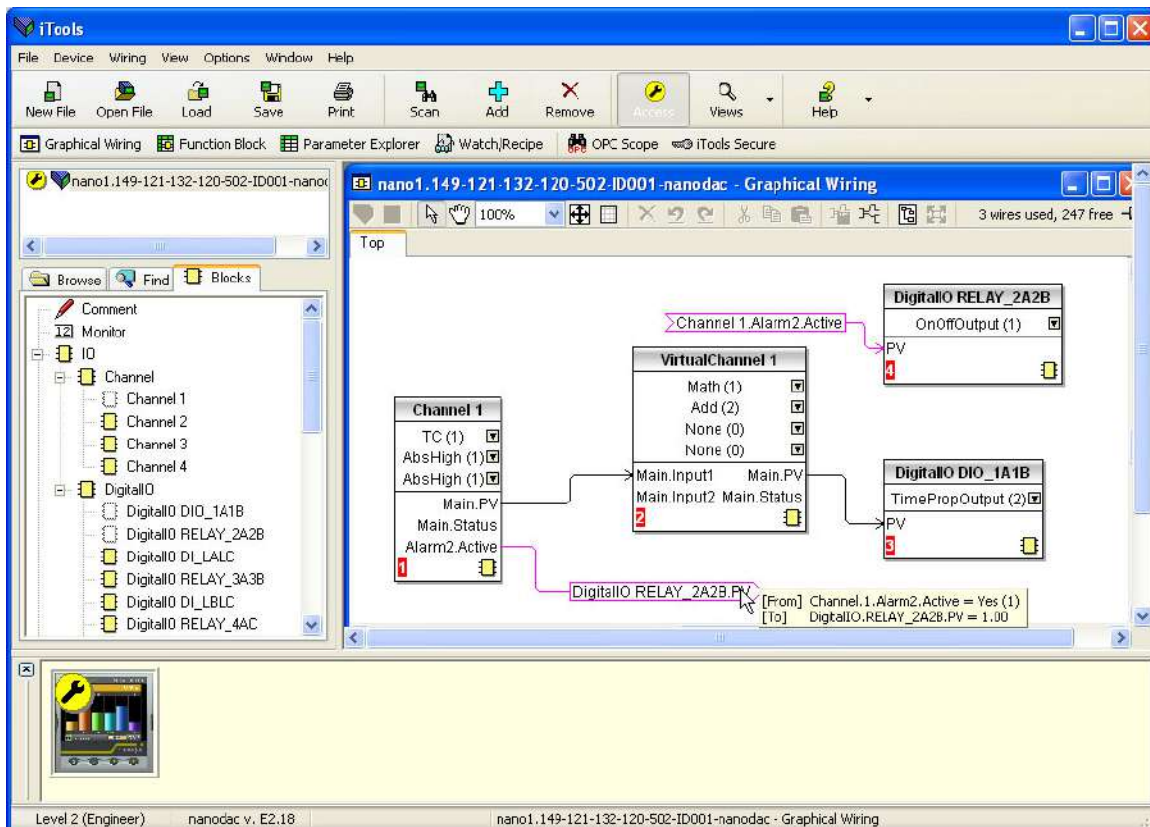





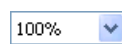



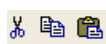

Figure 171 Graphical wiring Editor

The graphical wiring editor allows:

1. Function blocks, notes, comments etc. to be 'drag and dropped' into the wiring diagram from the tree list (left pane).
2. Parameters to be wired to one another by clicking on the output, the clicking on the required input.
3. Viewing and/or editing of parameter values by right-clicking on a function block and selecting 'Function Block View'.
4. The user to select parameter lists and to switch between parameter and wiring editors.
5. Completed wiring to be downloaded to the instrument (function blocks and wiring items with dashed outlines are new, or have been edited since the last download).

Tool bar



	Download wiring to instrument.
	Mouse select. Select normal mouse operation. Mutually exclusive with 'Mouse Pan' below.
	Mouse Pan. When active, this causes the mouse cursor to change to a hand-shaped icon. Allows the graphical wiring diagram to be click-dragged within the GWE window aperture.
	Zoom. Allows the magnification factor of the wiring diagram to be selected.
	Pan tool. Whilst left clicked, the cursor appears as a rectangle showing which part of the wiring diagram is currently displayed. Click dragging allows the rectangle to be moved freely about the diagram. The size of the rectangle depends on the zoom setting.
	Show/Hide grid. This toggles an alignment grid on and off.
	Undo, redo. Allows the user to undo the last action, or, once an undo action has taken place, to undo the undo. Short cuts are <Ctrl>+<Z>. for undo; <Ctrl>+<V>, for redo.
	Cut, Copy, Paste. Normal Cut (copy and delete), Copy (copy without delete) and Paste (insert into) functions. Shortcuts are: <Ctrl> + <X> for 'Cut'; <Ctrl> + <C> for copy and <Ctrl> + <V> for Paste.
	Copy diagram fragment; Paste diagram fragment. Allows a part of the wiring diagram to be selected, named and be saved to file. The fragment may then be pasted into any wiring diagram, including the source diagram.
	Create compound; Flatten compound. These two icons allow compounds to be created and 'un-created' (flattened).

Wiring Editor Operating Details

Component Selection

Single wires are shown with boxes at 'corners' when selected. When more than one wire is selected, as part of a group, the wire colour changes to magenta. All other items have a dashed line drawn round them when selected.

Clicking on a single item selects it. An Item can be added to the selection by holding down the control key (Ctrl) whilst clicking on the item. (A selected item can be deselected in the same way.) If a block is selected, then all its associated wires are also selected.

Alternatively, the mouse can be click-dragged on the background to create a 'rubber band' round the relevant area; anything within this area being selected when the mouse is released.

<Ctrl>+<A> selects all items on the active diagram.

Block Execution Order

The order in which the blocks are executed by the instrument depends on the way in which they are wired. Each block displays its place in its sequence in a coloured block in the bottom left-hand corner (Figure 172).

Function Blocks

A Function Block is an algorithm which may be wired to and from other function blocks to make a control strategy. Each function block has inputs and outputs. Any parameter may be wired from, but only parameters that are alterable in Operator Mode may be wired to. A function block includes any parameters that are needed to configure or operate the algorithm. The inputs and outputs which are considered to be of most use are always shown. In most cases all of these need to be wired before the block can perform a useful task.

If a function block is not faded in the tree (left hand pane) it can be dragged onto the diagram. The block can be dragged around the diagram using the mouse.

A Channel block is shown below as an example. When block type information is alterable (as in this case) click on the box with the down arrow in it to display a dialogue box allowing the value to be edited.

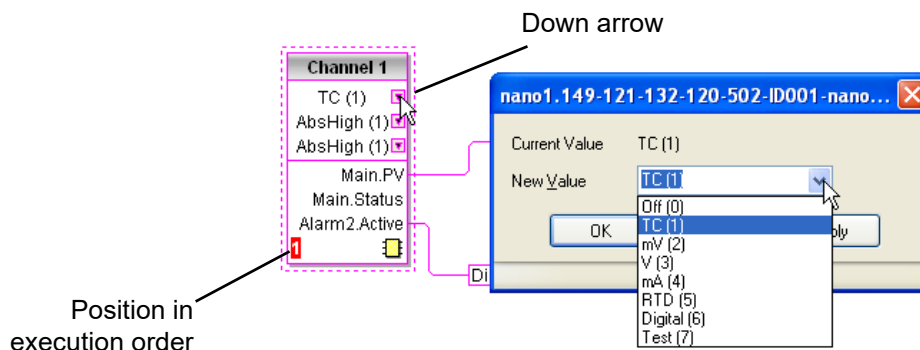

Figure 172 Function block example

If it is required to wire from a parameter, which is not shown as a recommended output, click on the 'Click to Select Output' icon in the bottom right hand corner to display a full list of parameters in the block (Figure 175, below). Click on one of these to start a wire.



Function Block Context Menu

Right-click in the function block to display the context menu.

- Function block view Displays a list of parameters associated with the function block. 'Hidden' parameters can be displayed by de-selecting 'Hide Parameters and Lists when not Relevant in the options menu 'Parameter availability setting...'. item.
- Re-Route wires Redraws all wiring associated with the function block.
- Re-route input wires Redraws all input wiring associated with the function block.
- Re-route output wires Redraws all output wiring associated with the function block.
- Show wiring using tags Wires are not drawn, but their start and end destinations are indicated by tags instead. Reduces wire clutter in diagrams where source and destination are widely separated. Hovering the cursor over the tag shows both its source and destination parameters and their values.

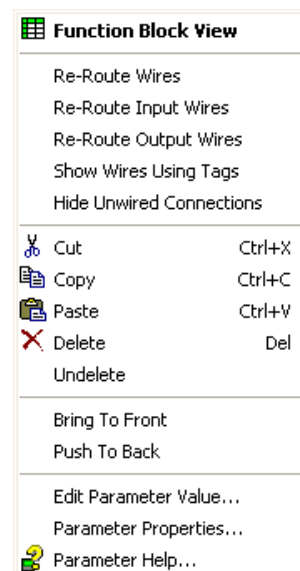

Figure 173 Function block context menu

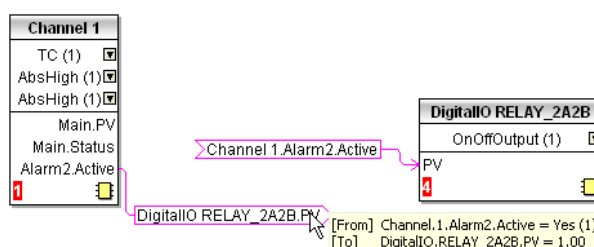

Figure 174 Function block context menu

Hide unwanted connections

Causes the display to include only wired items.

Cut

Allows one or more selected items to be moved to the Clipboard ready for pasting into another diagram or compound, or for use in a Watch window, or OPC scope. The original items are greyed out, and function blocks and wires are shown dashed until next download, after which they are removed from the diagram. Short cut = <Ctrl>+<X>. Cut operations carried out since the last download can be 'undone' by using the 'Undo' tool bar icon, by selecting 'Undelete' or by using the short cut <Ctrl>+<Z>.

Copy

Allows one or more selected items to be copied to the Clipboard ready for pasting into another diagram or compound, or for use in a Watch window, or OPC scope. The original items remain in the current wiring diagram. Short cut = <Ctrl>+<C>. If items are pasted to the same diagram from which they were copied, the items will be replicated with different block instances. Should this result in more instances of a block than are available, an error display appears showing details of which items couldn't be copied.

Paste

Copies items from the Clipboard to the current wiring diagram. Short cut = <Ctrl>+<V>. If items are pasted to the same diagram from which they were copied, the items will be replicated with different block instances. Should this result in more instances of a block than are available, a Paste error display appears showing details of those items which could not be copied.

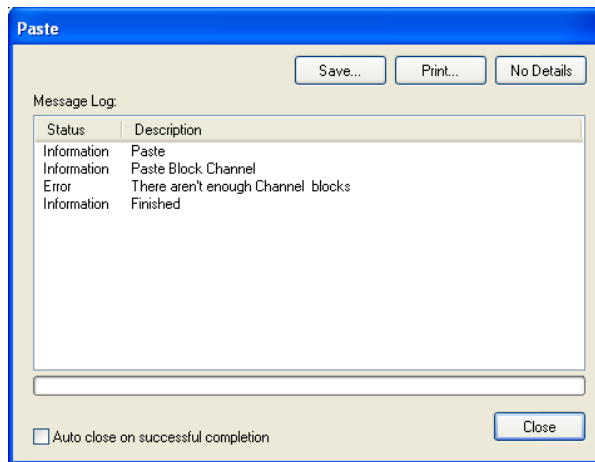
**Delete**

Marks all selected items for deletion. Such items are shown dashed until next download, after which they are removed from the diagram. Short cut = .

Undelete

Reverses 'Delete' and 'Cut' operations carried out on selected item(s) since the last download.

Bring to Front

Brings selected items to the front of the diagram.

Push to Back

Sends the selected items to the back of the diagram.

Edit Parameter Value...

This menu item is active if the cursor is hovering over an editable parameter. Selecting this menu item causes a pop-up window to appear, which allows the user to edit the parameter value.

Parameter Properties

This menu item is active if the cursor is hovering over an editable parameter. Selecting this menu item causes a pop-up window to appear, which allows the user to view the parameter properties, and also, to view the parameter Help (by clicking on the 'Help' tab).

Parameter Help

Produces Parameter Properties and Help information for the selected function block or parameter, depending on the hover position of the cursor, when the right-click occurs.

Wires

To make a wire:

1. Drag two (or more) blocks onto the diagram from the function block tree.

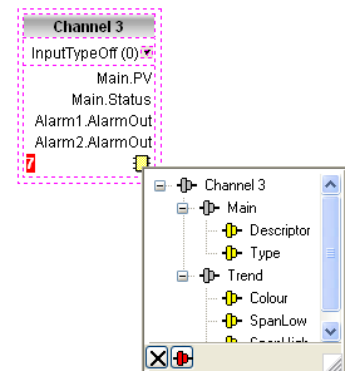

Figure 175 Output selection dialogue box.

2. Start a wire by either clicking on a recommended output or clicking on the 'Click to Select output' icon at the bottom right corner of the block to bring up the connection dialogue, and clicking on the required parameter. Recommended connections are shown with a green plug symbol; other parameters which are available being shown in yellow. Clicking on the red button causes all parameters to be shown. To dismiss the connection dialogue either press the escape key on the keyboard, or click the cross at the bottom left of the dialogue box.
3. Once the wire has started a dashed wire is drawn from the output to the current mouse position. To complete the wire click on the required destination parameter.
4. Wires remain dashed until they are downloaded.

Routing wires

When a wire is placed it is auto-routed. The auto routing algorithm searches for a clear path between the two blocks. A wire can be auto-routed again using the context menus or by double clicking the wire. A wire segment can be edited manually by click-dragging. If the block to which it is connected is moved, the end of the wire moves with it, retaining as much of the path as possible.

If a wire is selected by clicking on it, it is drawn with small boxes on its corners.

Wire Context Menu

Right click on a wire to display the wire block context menu:

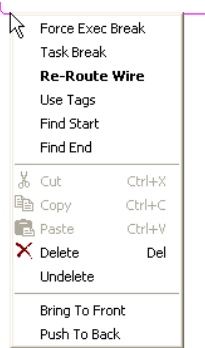
Force Exec Break	When wires form a loop, a break point must be introduced, where the value written to the block comes from a source which was last executed during the previous cycle. A break is automatically placed by iTools, and appears in red . Force Exec Break allows the user to define where a break must be placed. Surplus breaks appear in black.	
Task Break	Not used in this product.	
Re-Route wire	Replaces the current wire route with a new route generated from scratch.	
Use Tags	Toggles between wire and tag mode between parameters. Tag mode is useful for sources and destinations which are widely separated.	
Find Start	Goes to the source of the wire.	
Find End	Goes to the destination of the wire.	
Cut, Copy, Paste	Not used in this context.	
Delete	Marks the wire for deletion. The wire is redrawn as a dashed line (or dashed tags) until next download. Operation can be reversed until after next download.	
Undelete	Reverses the effect of the Delete operation up until the next download, after which, Undelete is disabled.	
Bring to Front	Brings the wire to the front of the diagram.	
Push to Back	Sends the wire to the back of the diagram.	

Wire Colours

Black	Normal functioning wire.
Red	The wire is connected to a non-changeable parameter. Values are rejected by the destination block.
Magenta	A normal functioning wire is being hovered-over by the mouse cursor.

Green

New Wire (dashed green wire changes to solid black after being downloaded).

Comments

Comments are added to a wiring diagram by click-dragging them from the Function Block tree onto the diagram.

As soon as the mouse is released, a dialogue box opens to allow the comment text to be entered. Carriage returns are used to control the width of the comment. Once text entry is complete, 'OK' causes the comment to appear on the diagram. There are no restrictions on the size of a comment. Comments are saved to the instrument along with the diagram layout information.

Comments can be linked to function blocks and wires by clicking on the chain icon at the bottom right-hand corner of the comment box and then clicking again on the required block or wire. A dashed line is drawn to the top of the block or to the selected wire segment (Figure 177).

Note: Once the comment has been linked, the Chain icon disappears. It re-appears when the mouse cursor is hovered over the bottom right-hand corner of the comment box.

Comment Context Menu

Edit	Opens the Comment dialogue box to allow the comment text to be edited.	
Unlink	Deletes the current link from the comment.	
Cut	Moves the comment to the Clipboard, ready to be pasted elsewhere. Short cut = <Ctrl>+<X>.	
Copy	Copies the comment from the wiring diagram to the Clipboard, ready to be pasted elsewhere. Short cut = <Ctrl>+<C>.	
Paste	Copies a comment from the Clipboard to the wiring diagram. Short cut = <Ctrl>+<V>.	
Delete	Marks the comment for deletion at next download.	
Undelete	Undoes the Delete command if download has not taken place since.	

Figure 176 Comment context menu

Monitors

Monitor points are added to a wiring diagram by click-dragging them from the Function Block tree onto the diagram. A monitor shows the current value (updated at the iTools parameter list update rate) of the parameter to which it is linked. By default the name of the parameter is shown. To hide the parameter name either double click on the monitor box or 'Show Names' in the context (right-click) menu can be used to toggle the parameter name on and off.

Monitors are linked to function blocks and wires by clicking on the chain icon at the bottom right-hand corner of the box and then clicking again on the required parameter. A dashed line is drawn to the top of the block or the selected wire segment.

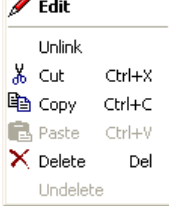
Note: Once the monitor has been linked, the Chain icon disappears. It re-appears when the mouse cursor is hovered over the bottom right-hand corner of the monitor box.

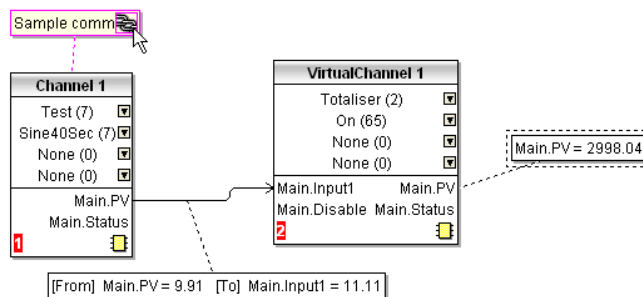

Figure 177 Comment and Monitor appearance

Monitor Context Menu

Show names	Toggles parameter names on and off in the monitor box. Unlink Deletes the current link from the monitor.	
Cut	Moves the monitor to the Clipboard, ready to be pasted elsewhere. Short cut = <Ctrl>+<X>.	
Copy	Copies the monitor from the wiring diagram to the Clipboard, ready to be pasted elsewhere. Short cut = <Ctrl>+<C>.	
Paste	Copies a monitor from the Clipboard to the wiring diagram. Short cut = <Ctrl>+<V>.	
Delete	Marks the monitor for deletion at next download.	
Undelete	Undoes the Delete command if download has not taken place since.	
Bring to Front	Moves the item to the 'top' layer of the diagram.	
Push to Back	Moves the item to the 'bottom' layer of the diagram.	
Parameter Help	Shows parameter help for the item.	

Figure 178 Monitor context menu

Downloading

When the wiring editor is opened the current wiring and diagram layout is read from the instrument. No changes are made to the instrument function block execution or wiring until the download button is pressed. Any changes made using the operator interface after the editor is opened are lost on download.

When a block is dropped onto the diagram, instrument parameters are changed to make the parameters for that block available. If changes are made and the editor is closed without saving them there is a delay while the editor clears these parameters.

During download, the wiring is written to the instrument which then calculates the block execution order and starts executing the blocks. The diagram layout including comments and monitors is then written into instrument flash memory along with the current editor settings. When the editor is reopened, the diagram is shown positioned as it was when it was last downloaded.

Colours

Items on the diagram are coloured as follows:

Red	Items which totally or partially obscure other items and items which are totally or partially obscured by other items. Wires that are connected to unalterable or non-available parameters. Execution breaks.
Blue	Non-available parameters in function blocks.

Green	Items added to the diagram since last download are shown as green dashed lines.
Magenta	All selected items, or any item over which the cursor is hovering.
Purple	Red wires when being hovered over by the mouse cursor.
Black	All items added to the diagram before the last download. Redundant execution breaks. Monitor and comment text.

Diagram Context Menu

Cut	Active only when the right click occurs within the bounding rectangle which appears when more than one item is selected. Moves the selection off the diagram to the Clipboard. Short cut = <Ctrl>+<X>.
Copy	As for 'Cut', but the selection is copied, leaving the original on the diagram. Short cut = <Ctrl>+<C>.
Paste	Copies the contents of the Clipboard to the diagram. Short cut = <Ctrl>+<V>.
Re-Route wires	Reroutes all selected wires. If no wires are selected, all wires are re-routed.
Align Tops	Aligns the tops of all blocks in the selected area.
Align Lefts	Aligns the left edges of all blocks in the selected area.
Space Evenly	Spaces selected items such that their top left corners are spaced evenly across the width of the diagram. Click on the item which is to be the left-most item, then <Ctrl>+<left click> the remaining items in the order in which they are to appear.
Delete	Marks the item for deletion at next download time. Can be 'Undeleted' up until download occurs.
Undelete	Reverses the action of 'Delete' on the selected item.
Select All	Selects all items on the current diagram.
Create Compound	Active only when the right click occurs, in the top level diagram, within the bounding rectangle which appears when more than one item is selected. Creates a new wiring diagram as described in 'Compound', below.
Rename	Allows a new name to entered for the current wiring diagram. This name appears in the relevant tab.
Copy Graphic	Copies the selected items (or the whole diagram if no items are selected) to the clipboard as a Windows metafile, suitable for pasting into a documentation application. Wiring entering/leaving the selection (if any) are drawn in tag mode.
Save Graphic...	As for 'Copy Graphic' above, but saves to a user-specified file location instead of the clipboard.
Copy Fragment To File...	Copies selected items to a user-named file in folder 'My iTools Wiring Fragments' located in 'My Documents'.
Paste Fragment From File	Allows the user to select a stored fragment for inclusion in the wiring diagram.
Centre	Places the display window at the centre of the selected items. If 'Select All' has previously been clicked-on, then

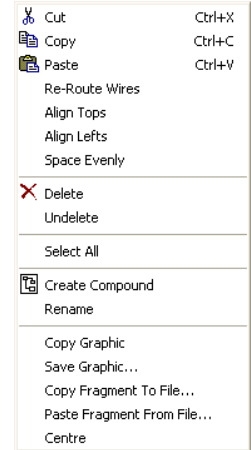

Figure 179 Diagram context menu

Compounds

Compounds are used to simplify the top level wiring diagram, by allowing the placing of any number of function blocks within one 'box', the inputs and outputs of which operate in the same way as those of a normal function block.

Each time a compound is created, a new tab appears at the top of the wiring diagram. Initially compounds and their tabs are named 'Compound 1', 'Compound 2', etc. but they can be renamed by right clicking either on the compound in the top level diagram, or anywhere within an open Compound, selecting 'Rename' and typing in the required text string (16 characters max).

Compounds cannot contain other compounds (i.e. they can be created only in the top level diagram).

Compound creation

1. Empty compounds are created within the top level diagram by clicking on the 'Create Compound' tool bar icon.
2. Compounds can also be created by highlighting one or more function blocks in the top level diagram and then clicking on the 'Create Compound' tool bar icon. The highlighted items are moved from the top level diagram
3. Compounds are 'uncreated' (flattened), by highlighting the relevant item in the top level menu and then clicking on the 'Flatten Compound' tool bar icon. All the items previously contained within the compound appear on the top level diagram.
4. Wiring between top level and compound parameters is carried out by clicking on the source parameter, then clicking on the compound (or the compound tab) and then clicking on the destination parameter. Wiring from a compound parameter to a top level parameter or from compound to compound is carried out in similar manner.
5. Unused function blocks can be moved into compounds by dragging from the tree view. Existing blocks can be dragged from the top level diagram, or from another compound, onto the tab associated with the destination compound. Blocks are moved out of compounds to the top level diagram or to another compound in a similar way. Function blocks can also be 'cut and pasted'.
6. Default compound names (e.g. 'Compound 2') are used only once, so that if, for example, Compounds 1 and 2 have been created, and Compound 2 is subsequently deleted, then the next compound to be created will be named 'Compound 3'.
7. Top level elements can be click-dragged into compounds.

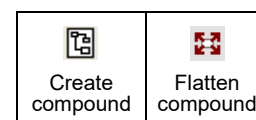

Tool Tips

Hovering the cursor over the block displays 'tooltips' describing that part of the block beneath the cursor. For function block parameters the tooltip shows the parameter description, its OPC name, and, if downloaded, its value. Similar tooltips are shown when hovering over inputs, outputs and over many other items on the iTools screen.

A Function Block is enabled by dragging the block onto the diagram, wiring it, and finally downloading it to the instrument. Initially blocks and associated wires are drawn with dashed lines, and when in this state the parameter list for the block is enabled but the block is not executed by the instrument.

The block is added to the instrument function block execution list when the 'Download' icon is operated and the items are redrawn using solid lines. If a block which has been downloaded is deleted, it is shown on the diagram in a ghosted form until the download button is pressed. (This is because it and any wires to/from it are still being executed in the instrument. On download it will be removed from the instrument execution list and the diagram.) A ghosted block can be 'undeleted' as described in 'Context menu', above.

When a dashed block is deleted it is removed immediately.

Parameter Explorer Parameter Explorer

This view can be displayed:

1. by clicking on the 'Parameter Explorer' toolbar icon,
2. by double clicking on the relevant block in the tree pane or in the graphical wiring editor,
3. by selecting 'Function Block View' from the Function block context menu in the Graphical wiring Editor,
4. by selecting 'parameter Explorer from the 'View' menu,
5. by using the short cut <Alt>+<Enter>.

In each case the function block parameters appear in the iTools window in tabular form, such as the example in [Figure 180](#), below.

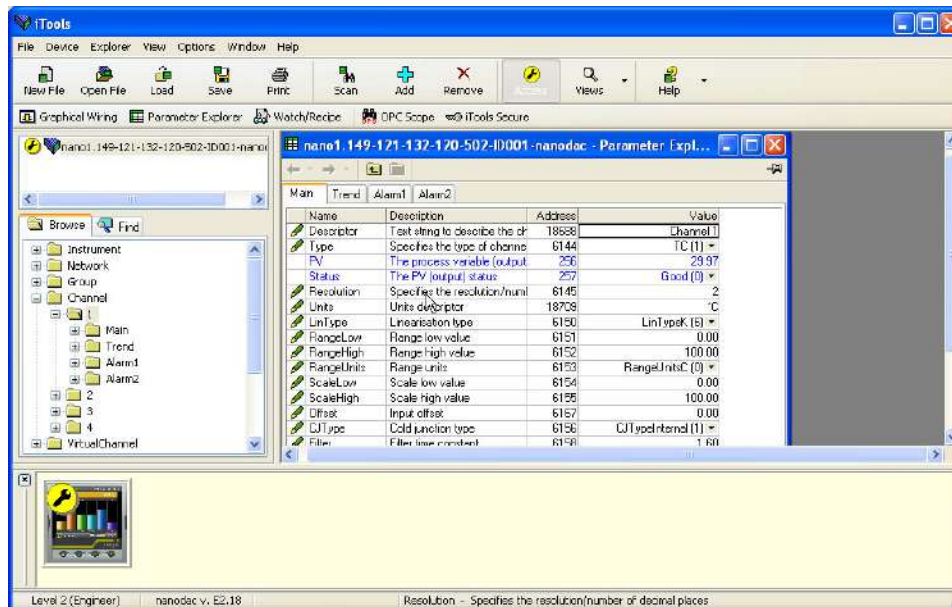

Figure 180 Parameter table example

The figure above shows the default table layout. Columns can be added/deleted from the view using the 'Columns' item of the Explorer or context menus ([Figure 181](#)).

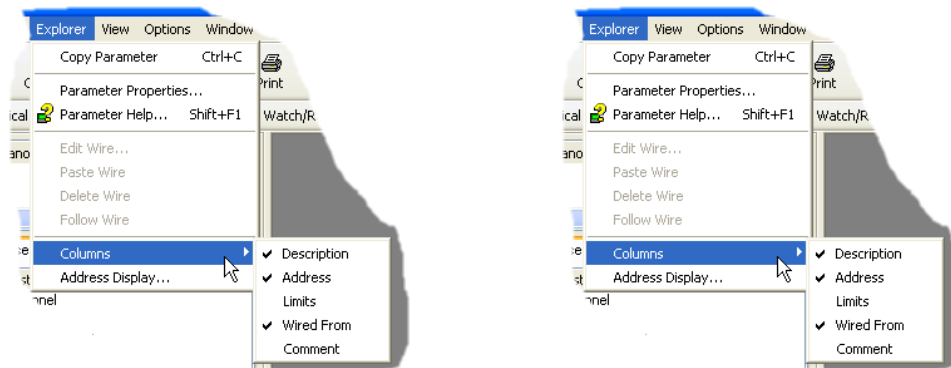

Figure 181 Column enable/disable

Parameter explorer detail

Figure 182 shows a typical parameter table. This particular parameter has a number of subfolders associated with it, and each of these is represented by a 'tab' across the top of the table.

Name	Description	Address	Value	Wired From
Descriptor	Text string to describe the channel	18688	Channel 1	
Type	Specifies the type of channel	6144	TC (1)	
PV	The process variable (output) of the channel	256	37.38	
Status	The PV (output) status	257	Good (0)	
IPAdjustState	Input Adjust state either Unadjusted or Adjusted	6166	Unadjusted (0)	
PV2	The secondary input process variable (output) of the channel	272	0.00	
Status2	The secondary input PV (output) status	273	Good (0)	
IPAdjustState2	Secondary Input Adjust state either Unadjusted or Adjusted	6172	Unadjusted (0)	
OpenString	Open String	18796	Open	
CloseString	Close String	18832	Closed	
Resolution	Specifies the resolution/number of decimal places	6145	1	
Units	Units descriptor	18709	°C	
TestSignal	Test signal	6146	Triangle5Hr (0)	
InputLow	Input range low value	6147	0.00	
InputHigh	Input range high value	6148	1.00	
Shunt	Shunt value	6149	2.49	
LinType	Linearisation type	6150	LinTypeK (6)	
RangeLow	Range low value	6151	0.00	
RangeHigh	Range high value	6152	50.00	
RangeUnits	Range units	6153	RangeUnitsC (0)	
ScaleLow	Scale low value	6154	0.00	
ScaleHigh	Scale high value	6155	50.00	
ScaleLow2	Scale low value for the secondary input	6170	0.00	
ScaleHigh2	Scale high value for the secondary input	6171	50.00	
Offset	Input offset	6167	0.00	
Offset2	Secondary input offset	6168	0.00	
CJType	Cold junction type	6156	CJTypeInternal (1)	
ExtCJTemp	External CJ temperature	6157	0.00	
Filter	Filter time constant	6158	1.60	

Channel.1.Main - 38 parameters

Figure 182 Typical parameter table

Notes:

- Parameters in blue are non-editable (Read only). In the example above all the parameters are read only. Read/write parameters are in black and have a 'pencil' symbol in the 'read/ Write access column at the left edge of the table. A number of such items are shown in Figure 182, above.
- Columns. The default explorer window (Figure 179) contains the columns 'Name', 'Description', 'Address', 'Value', and 'Wired From'. As can be seen from Figure 180, the columns to be displayed can be selected, to a certain extent, using either the 'Explorer' menu or the context menu.
- Hidden Parameters. By default, iTools hides parameters which are considered irrelevant in the current context. Such hidden parameters can be shown in the table using the 'Parameter availability' settings item of the options menu (Figure

4. The full pathname for the displayed parameter list is shown at the bottom left hand corner of the window.

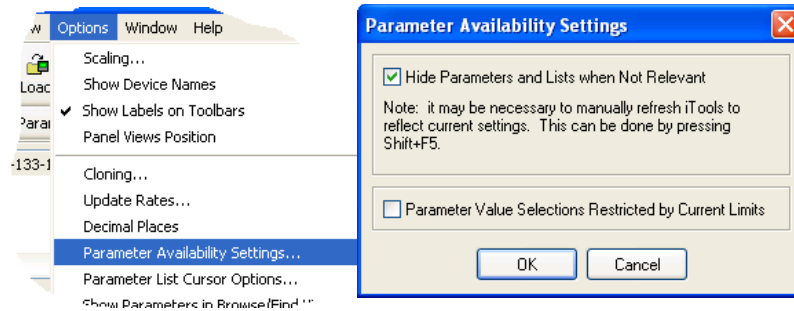





Figure 183 Show/Hide parameters

Explorer tools

A number of tool icons appear above the parameter list:

- 

Back to: and Forward to:.. The parameter explorer contains a history buffer of up to 10 lists that have been browsed in the current instance of the window. The 'Back to: (list name)' and 'Forward to: (list name)' icons allow easy retracing or repeating of the parameter list view sequence. If the mouse cursor is hovered over the tool icon, the name of the parameter list which will appear if the icon is clicked-on appears. Clicking on the arrow head displays a pick list of up to 10 previously visited lists which the user can select. Short cut = <Ctrl>+ for 'Back to' or <Ctrl>+<F> for 'Forward to'.
- 

Go Up a Level, Go Down a Level. For nested parameters, these buttons allow the user to navigate 'vertically' between levels. Short cut = <Ctrl>+<U> for 'Go Up a Level' or <Ctrl>+<D> for 'Go Down a Level'.
- 

Push pin to give the window global scope. Clicking on this icon causes the current parameter list to be permanently displayed, even if another instrument becomes the 'current device'.

Context Menu

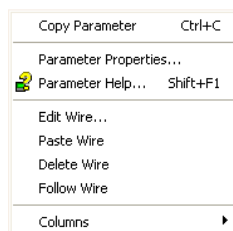

- Copy Parameter Copies the clicked-on parameter to the clipboard
- Parameter properties Displays parameter properties for the clicked-on parameter
- Parameter Help... Displays help information for the clicked-on parameter
- Edit/Paste/Delete/Follow Wire Not used in this application
- Columns Allows the user to enable/disable a number of parameter table columns (Figure 182).

Watch/Recipe Editor Watch/Recipe

The watch/recipe editor is opened by clicking on the Watch/Recipe tool icon, by selecting 'Watch/Recipe' in the 'Views' menu or by using the short cut <Ctrl>+<A>. The window is in two parts: the left part containing the watch list; the right-hand part containing one or more data sets, initially empty and unnamed.

The Watch/Recipe window is used:

1. To monitor a list of parameters. This list can contain parameters from many different, and otherwise unrelated parameter lists within the same device. It cannot contain parameters from different devices.
2. To create 'data sets' of parameter values which can be selected and downloaded to the device in the sequence defined in the recipe. The same parameter may be used more than once in a recipe.

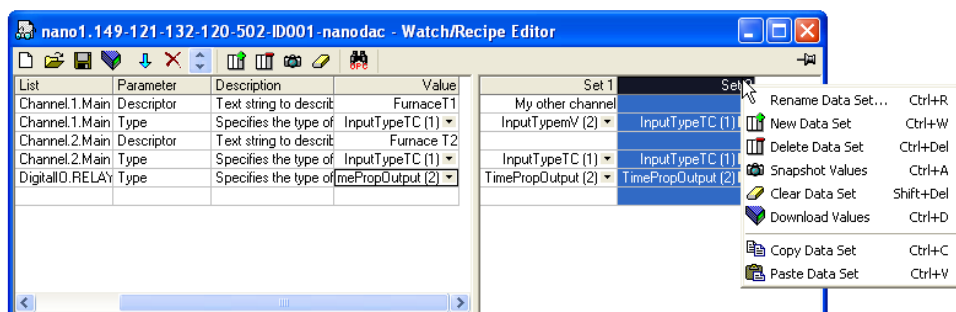



Figure 184 Watch/Recipe Editor window (with context menu)

Creating a Watch List

After opening the window, parameters can be added to it as described below. The values of the parameters update in real-time, allowing the user to monitor a number of values simultaneously.

Adding Parameters to the Watch List

1. Parameters can be click-dragged into the watch list from another area of the iTools window (for example, the parameter explorer window, the graphical wiring editor, the browse tree). The parameter is placed either in an empty row at the bottom of the list, or if it is dragged on top of an already existing parameter, it is inserted above this parameter, with the remaining parameters being moved down one place.
2. Parameters can be dragged from one position in the list to another. In such a case, a copy of the parameter is produced, the source parameter remaining in its original position.
3. Parameters can be copied <Ctrl>+<C> and pasted <Ctrl>+<V> either within the list, or from a source external to it, for example the parameter browse window or the graphical wiring editor.
4. The 'Insert item...' tool button  the 'Insert Parameter' item in the Recipe or context menu or the short cut <Insert> can be used to open a browse window from which a parameter is selected for insertion above the currently selected parameter.

Data Set Creation

Once all the required parameters have been added to the list, select the empty data set by clicking on the column header. Fill the data set with current values using one of the following methods:

1. Clicking on the 'Capture current values into a data set' tool icon  (also known as the 'Snapshot Values' tool).
2. Selecting 'Snapshot Values' from the Recipe or Context (right-click) menu.
3. Using the short cut <Ctrl>+<A>.

Individual data values can now be edited by typing directly into the grid cells. Data values can be left blank or cleared, in which case, no values will be written for those parameters at download. Data values are cleared by deleting all the characters in the cell then either moving to a different cell or pressing <Enter>.

The set is called 'Set 1' by default, but it can be renamed by either by using the 'Rename data set...' item in the Recipe or context menus, or by using the short cut <Ctrl>+<R>.













New, empty data sets can be added using one of the following:

1. Clicking on the 'Create a new empty data set' toolbar icon.
2. Selecting 'New Data Set' in the Recipe or context menus
3. Using the short cut <Ctrl>+<W>

Once created, the data sets are edited as described above.

Finally, once all the required data sets have been created, edited and saved, they can be downloaded the instrument, one at a time, using the Download tool, the 'Download Values' item in the Recipe or context menus, or the short cut <Ctrl>+<D>.

Watch Recipe toolbar icons

-  Create a new watch/recipe list. Creates a new list by clearing out all parameters and data sets from an open window. If the current list has not been saved, confirmation is requested. Short cut <Ctrl>+<N>
-  Open an existing watch/recipe file. If the current list or data set has not been saved, confirmation is requested. A file dialogue box then opens allowing the user to select a file to be opened. Short cut <Ctrl>+<O>
-  Save the current watch/recipe list. Allows the current set to be saved to a user specified location. Short cut <Ctrl>+<S>.
-  Download the selected data set to the device. Short cut <Ctrl>+<D>
-  Insert item ahead of selected item. Short cut <Insert>.
-  Remove recipe parameter. Short cut <Ctrl>+<Delete>.
-  Move selected item. Up arrow moves selected parameter up the list; down arrow move the selected parameter down the list.
-  Create a new empty data set. Short cut <Ctrl>+<W>.
-  Delete an empty data set. Short cut <Ctrl>+<Delete>
-  Capture current values into a data set. Fills the selected data set with values. Short cut <Ctrl>+<A>.
-  Clear the selected data set. Removes values from the selected data set. Short cut <Shift>+<Delete>.
-  Open OPC Scope. Opens a separate utility that allows trending. data loading

Watch/Recipe Context Menu

The Watch/Recipe Context menu items have the same functions as described above for toolbar items.

Programmer Option

Clicking on the Programmer tool bar icon opens the programmer configuration window, displaying the program currently loaded in the instrument, in Segment Parameter view. If no program is loaded, the programmer display opens with just one segment, defined as an 'End' Segment.

Figure 185 shows a simple program for example purposes. Parameters are defined in section 3.4.9 and section 4.8.

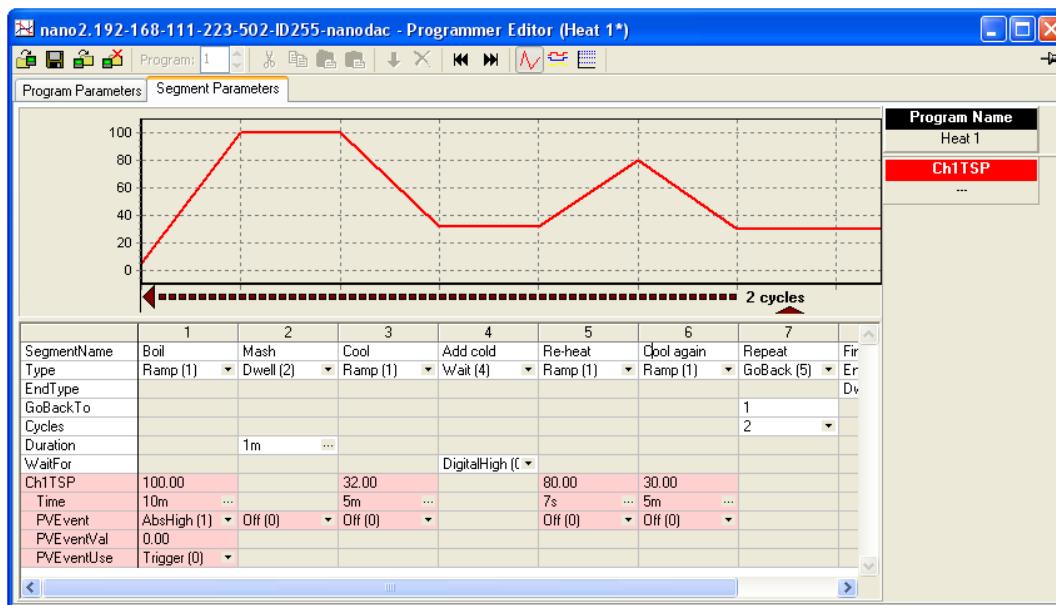

Figure 185 Programmer display

As can be seen from the example, the segments appear below a graphical representation of the program.

Segment parameter editing

Segment Name

To edit the segment name, click in the segment name field (as shown), and type in the required text, of up to 20 characters. Alternatively, double click on the existing name and edit it as desired.

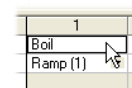

Segment Type

Clicking on the down arrow symbol to the right of the existing segment type field, produces a pick list from which a segment type can be selected. The type of segment selected defines which configuration fields appear for that segment.

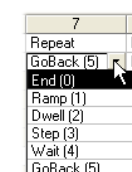

End Type

Allows the selection of 'Dwell' or 'Reset' as the action to be taken by the End segment.

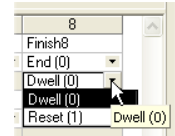

Go Back to

For GoBack segments only, this allows the user to enter a segment number for the program to return to.

Cycles

For GoBack segments only, this allows the number of times the program returns to the 'Go Back To' segment, before continuing.

Duration

Sets the amount of time for which Dwell segments are to operate. Times are entered using a hours/minutes/seconds/ milliseconds display which appears when the ellipsis button to the right of the duration field is clicked on.

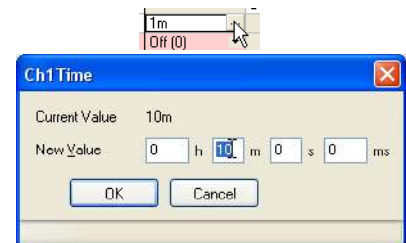

Wait for

Select an analogue or digital input as the wait criterion. For single channel programs only one analogue input is available; for two-channel programmers one digital and two analogue inputs are available, as shown.

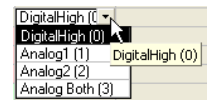

CH1 (2) TSP

The channel 1 (2) target setpoint, editable by the user in a similar way as that used for segment name editing, described above. Ch2 TSP appears only for two channel programmers.

Time

For programs where 'Ramp Style' = 'Time', this allows the user to enter time periods for ramp segments, in a similar way, as described for 'Duration', above. For two channel programmers, two times can be entered, and if the two times are different, the channel with the shorter time waits at its setpoint value until the other channel's time has elapsed.

Rate

For programs where 'Ramp Style' = 'Rate', this allows the user to enter a rate value for Ramp segments. This value is entered in the same way as that used for segment name editing, described above. For two channel programmers, two rates can be entered.

Other Parameters

Holdback, PV Event etc. parameters may or may not appear depending on the programmer features enabled, and they are all edited in the ways described above.

Digital Event display

Clicking on the 'Digital Events Output' tool bar icon produces a segment display, allowing the user to select the events on or off as required, for each segment. [Figure 186](#) shows a programmer where the number of events is four.

The number of events which appear (maximum eight) is configured in the Programmer Setup menu as described in "Programmer Setup menu" on page 175.

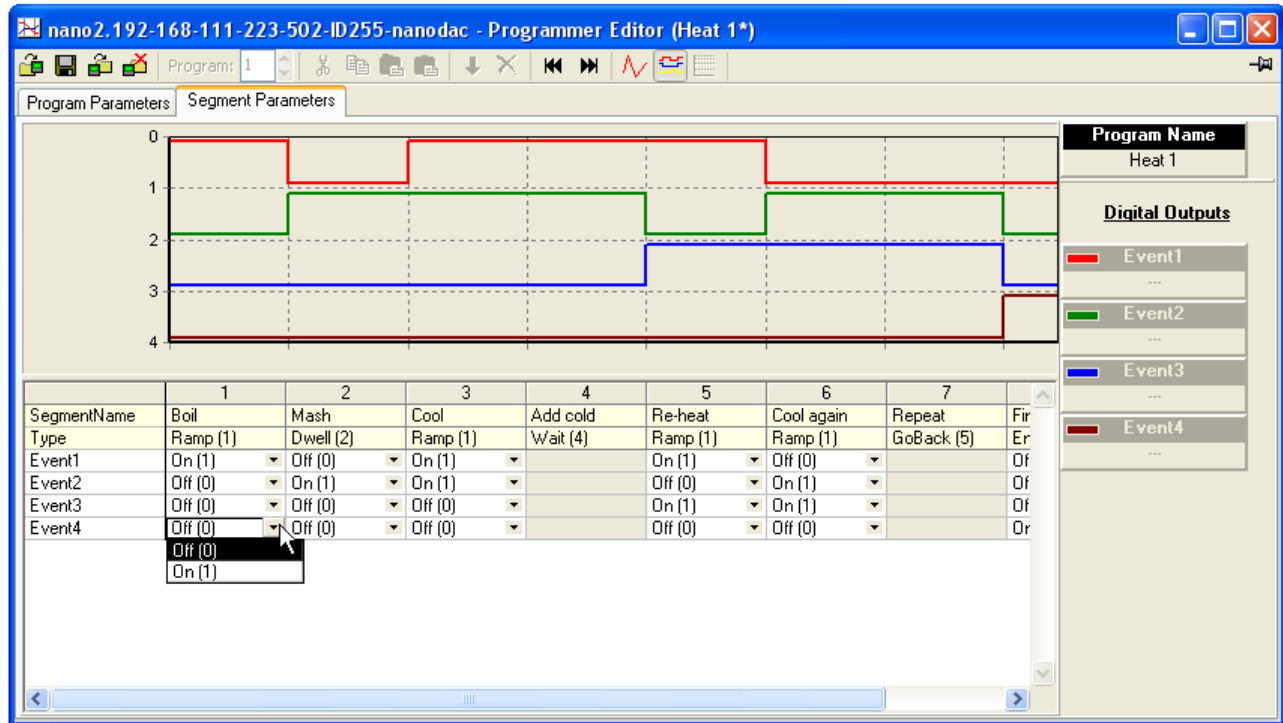

Figure 186 Event on/off configuration

Program parameters

The number of parameters which appear in this display depends on which program features are enabled. [Figure 187](#) shows a basic set of parameters which allows the user to select Rate or Time as the Ramp style, and to select a value for Rate units.

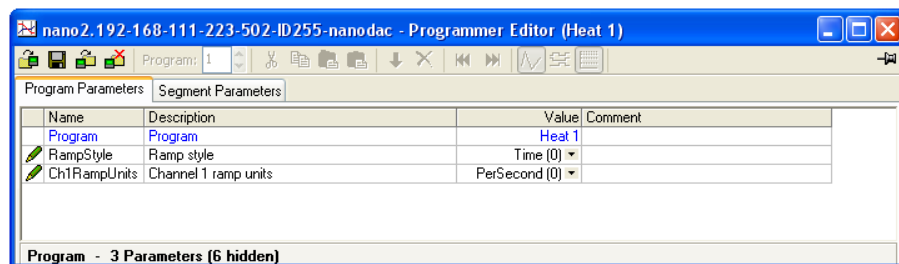

Figure 187 Program parameter display

Adding and deleting segments

Insert Segment

As shown in Figure 188, to insert a segment, click in the segment number field of the segment to the right of where the new segment is to be located. This causes the whole segment to highlight. Click on the blue down arrow tool icon to insert the new segment. The new segment name is the segment number, and the segment configuration is that of the segment to the right, unless that segment is a Goback or End segment, in which case the new segment is a ramp segment.

To insert more than one segment, press the Shift key whilst clicking on the range of contiguous segments to be copied.

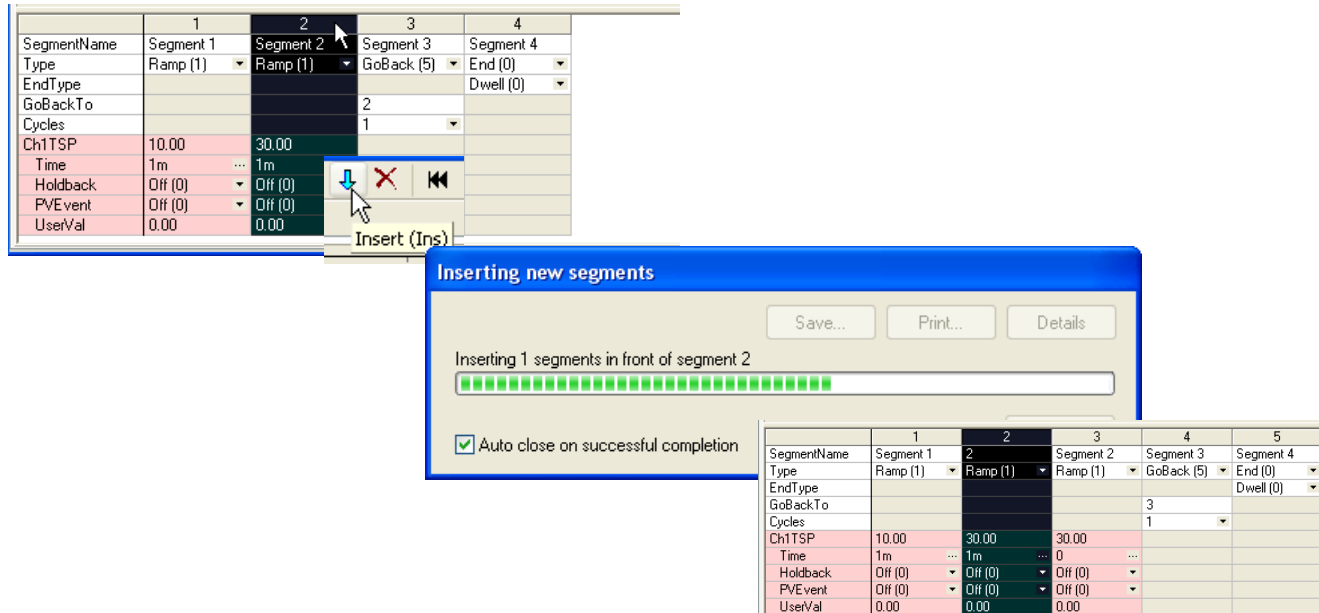

Figure 188 Insert a segment

Alternatively the mouse can be right-clicked anywhere in a segment, and the 'Insert segment' item selected, or one or more segment can be highlighted and the 'Insert' key on the PC keyboard used to initiate the process. See Section "Context Menu" on page 366 for more details of the right-click (context) menu.

Cutting, Copying and Pasting Segments



The process of highlighting one or more segments causes the cut and copy toolbar icons to become active.

The cut tool removes the highlighted segments from the program and stores them on the pasteboard ready for re-use. The copy tool copies the selected segment(s) to the paste board, leaving the original segment(s) in place. Once one or more segments have been cut or copied, the 'Paste insert' and 'Paste over' icons become active

allowing the user to paste the contents of the pasteboard in front of a selected segment (Paste insert), or to overwrite the existing highlighted segment(s) (Paste over). When using the Paste over tool, the number of segments being pasted over must match the number of segments on the paste board.

Deleting Segments

Once one or more segments have been highlighted, the highlighted segments can be removed using the Delete toolbar icon, by using the Delete Segment item in the right-click (context) menu, or by operating the PC keyboard 'Ctrl' and Delete' keys simultaneously.







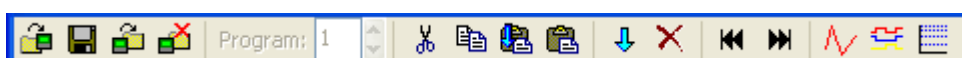





Loading and Saving programs

The four program operation keys at the top left of the programmer window allow the user to load a program from or save a program to either the currently connected instrument or to a PC. The fourth icon allows the user to select a program to be deleted from the connected instrument. See Section "Toolbar icons" on page 373 for more details.

Toolbar icons



The toolbar icons appearing at the top of the programmer window have the following properties:

-  Load Program. Opens a browser window allowing the user to select a program on the PC, or a program stored in the connected instrument to load. Short cut: <Ctrl>+<L>.
-  Save current program to file. Opens a browser window allowing the user to select a location on the pc in which to save the current program. This file is saved with a '.upiz' extension and can be saved to a USB memory stick for downloading to an instrument, or it can be transferred to the instrument via an FTP server. Short cut: <Ctrl>+<S>.
-  Store current program on device. Allows the user to save the program to the program store on the instrument. Short cut: <Shift>+<Ctrl>+<S>.
-  Delete Programs from Device. Allows the user to delete programs from the program store on the connected instrument. Short cut: <Ctrl>+<F>.
-  Cut. Removes the highlighted segment(s) from the program and places them on the pasteboard. Short cut: <Ctrl>+<X>.
-  Copy. Copies the selected segment(s) to the pasteboard, leaving the original segments in place. Short cut: <Ctrl>+<C>.
-  Paste insert. Inserts the segments on the pasteboard into a location to the left of the highlighted segment. Short cut: <Ctrl>+<V>.
-  Paste over. Overwrites the highlighted segment(s) with the segment(s) on the pasteboard. The number of segments on the pasteboard must match the number of segments being overwritten. Short cut: <Shift>+<Ctrl>+<V>.
-  Insert. Inserts a new segment to the left of the highlighted segment. If more than one segment is highlighted, then the same number of segments are inserted as are highlighted. Copies the segment type of the segment to the right of the insertion point except if that segment is an 'End' or 'GoBack' segment, when newly inserted segments are of type 'Ramp'. Short cut: <Insert>.
-  Delete. Deletes the highlighted segment(s). Short cut: <Ctrl>+<Delete>.
-  Go to first. Moves the user to the first segment. Useful in very long programs. Short cut: <Ctrl>+<Left arrow>.
-  Go to last. Moves the user to the end segment. Useful in very long programs. Short cut: <Ctrl>+<Right arrow>.
-  Analog. Selects the analogue trace chart for display and segment configuration. Short cut: <Ctrl>+<G>.



Digital Event Outputs. Selects the Event output chart for display and configuration. Short cut: <Ctrl>+<D>.



Logarithmic. Switches the vertical scale to logarithmic. Short cut: <Ctrl>+<M> (Figure 188).

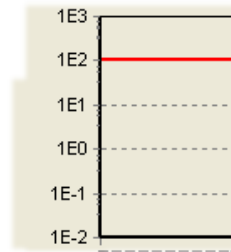

Figure 189 Logarithmic scale example

Context menus

Segment Context Menu

Right-clicking when the mouse cursor is hovering over a segment in the ana-logue segment parameters view produces the segment context menu shown. The various items copy the relevant tool bar icons described above, with the following additions:

Select All	Selects all parameters
Parameter properties	Displays the properties window for the parameter right-clicked on, including a 'Help' tag for that parameter.

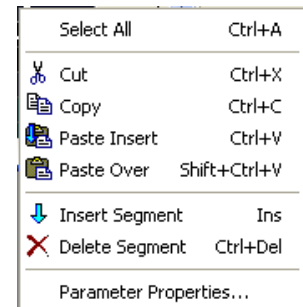

Program Context Menu

Right-clicking when the mouse cursor is hovering in the program param-eters view produces the program context menu shown.

Parameter properties	Displays the properties window for the parameter right-clicked on, including a 'Help' tag for that parameter.
Columns	Allows the user to enable/disable columns in the program parameters display.

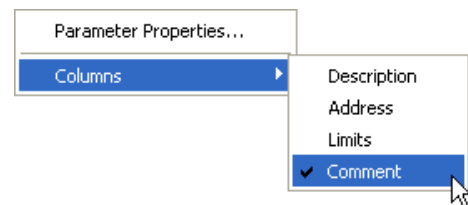
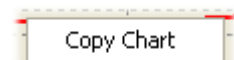

Chart Context Menu

Right-clicking when the mouse cursor is hovering over the analogue chart or the digital event chart produces the segment context menu shown. This allows the user to copy the chart to the pasteboard, from where it can be pasted into (for example) a standard word processing document.



Programmer menu

Clicking on the 'Programmer' menu item near the top of the iTools window causes the Programmer menu (Figure 190) to appear. The items contained within this menu are described in the 'Toolbar icons' and 'Context menu' sections (Section "Toolbar icons" on page 373 and Section "Context Menu" on page 366, respectively) above.

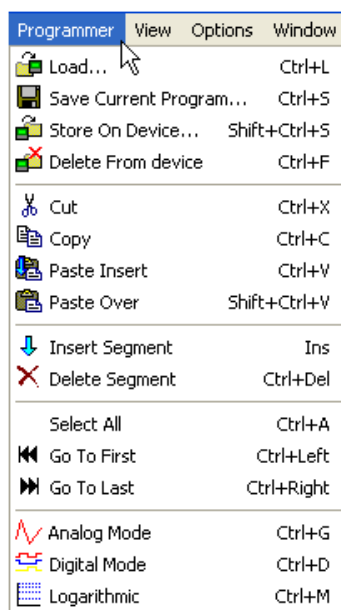

Figure 190 Programmer menu

Two channel programs

The display and editing of segment and program parameters for two-channel programmers is carried out in the same way as described above, for single channel programs. The major difference in appearance is that there are two sets of parameters for each segment, instead of one. The background colour for channel 1 parameters is pink; that for channel 2 parameters is green.

The number of channels and the program features enabled are set up at the instrument as described in "Steriliser Display Mode" on page 70 and "Programmer Configuration" on page 171.

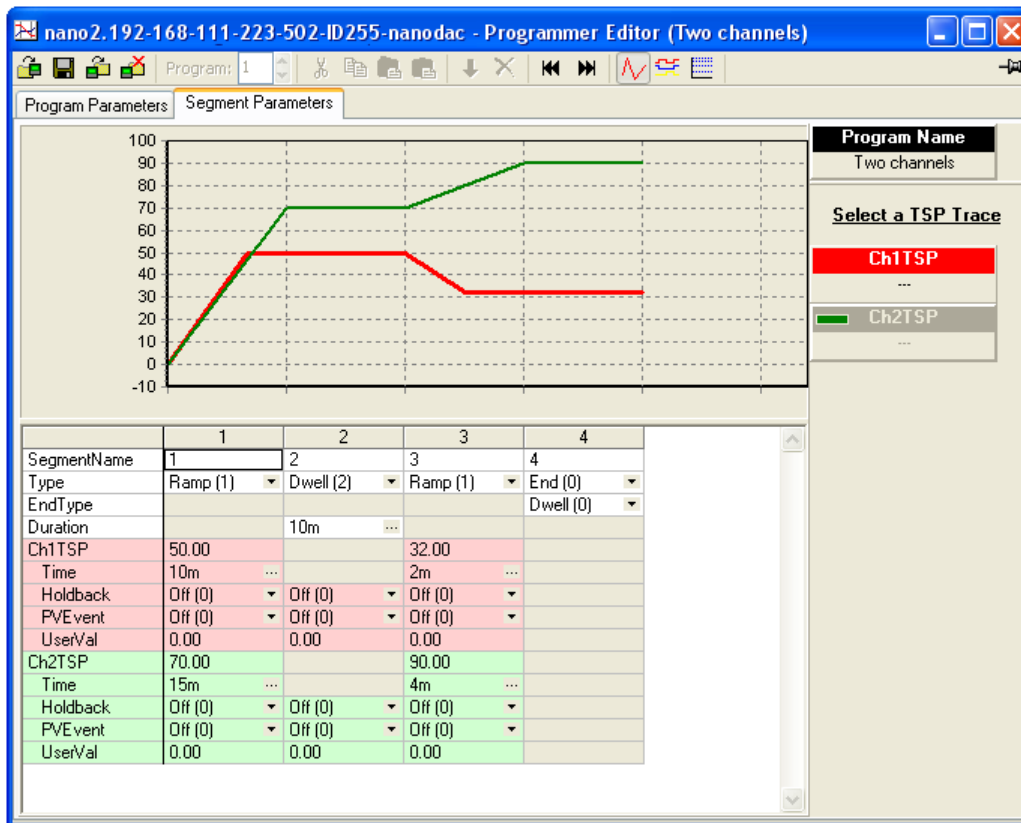

Figure 191 Two channel program display

To Set Up OEM Security

This will be illustrated by the following two examples:

Example 1:

Make the parameter Network.Modbus.TimeFormat read/write when OEM security is enabled and the instrument is in Engineer access level and leave the remaining parameters in this list as read only.

Select
Engineer
(Configuration)
access
level

With OEM
status
unlocked set
'OEMParam
sLists' to On.

Name	Description	Address	Value
EngineerPassword	Engineer pass phrase	3892314888
SupervisorPassword	Supervisor pass phrase	3892314889
OperatorPassword	Operator pass phrase	3892314890
FeaturePass	Features pass code	4291	31030
Feature2Pass	Features2 pass code	4292	13689
Feature3Pass	Features3 pass code	4293	5677
CommsPass	Comms pass enable	4289	Enabled (1)
PassPhrase	The parameter to be written to if comms security is enabled	17430
EngineerAccess	Indication of the requirement for the engineer pass phrase	4288	1
OEMPass	OEM pass phrase	3892314895
OEMParamLists	OEM Parameter Lists	4295	On (1)
OEMEntry	OEM pass phrase entry	28001
OEMStatus	OEM status	4294	Unlocked (0)
DefaultConfig	Default all configuration parameters	4290	No (0)

Instrument.Security - 14 parameters

Open
'Network.Modbus list

Name	Description	Address	Value	Wired From
PreferMasterIP	Preferred master IP	18076	192.168.111.111	
Address	Modbus address	4416	1	
InputTimeout	Modbus Input inactivity timeout (in seconds)	4417	0	
UnitIDEnable	Unit ident enable	4418	Strict (0)	
TimeFormat	Time parameter comms resolution	4420	seconds (1)	

Network.Modbus - 5 parameters

Open
'Instrument.OEMConfig List'

Name	Description	Address	Value	Wired From
Parameter1	Parameter that is to be alterable	4556	3925869683	Network.Modbus.TimeFormat
Parameter2	Parameter that is to be alterable	4557	4294967295	(not wired)
Parameter3	Parameter that is to be alterable	4558	4294967295	(not wired)
Parameter4	Parameter that is to be alterable	4559	4294967295	(not wired)
Parameter5	Parameter that is to be alterable	4560	4294967295	(not wired)
Parameter6	Parameter that is to be alterable	4561	4294967295	(not wired)
Parameter7	Parameter that is to be alterable	4562	4294967295	(not wired)
Parameter8	Parameter that is to be alterable	4563	4294967295	(not wired)
Parameter9	Parameter that is to be alterable	4564	4294967295	(not wired)
Parameter10	Parameter that is to be alterable	4565	4294967295	(not wired)
Parameter11	Parameter that is to be alterable	4566	4294967295	(not wired)
Parameter12	Parameter that is to be alterable	4567	4294967295	(not wired)
Parameter13	Parameter that is to be alterable	4568	4294967295	(not wired)
Parameter14	Parameter that is to be alterable	4569	4294967295	(not wired)
Parameter15	Parameter that is to be alterable	4570	4294967295	(not wired)

Instrument.OEMConfigList - 100 parameters

Drag and drop the parameter(s) which are required to be read/write in Engineer level when OEM security is enabled. In this example the parameter 'TimeFormat'.

Example 2:

Make the parameter 'Loop1.PID.ProportionalBand' read only when OEM security is enabled and the instrument is in Supervisor access level and leave the remaining parameters in this list as read/write.

Name	Description	Address	Value	Wired From
SchedulerType	Scheduler Type	5685	Off (0)	
NumSets	Number of PID Sets	5686	1	
SchedulerRemoteInput	Scheduler Remote Input	5687	0.00	
ActiveSet	Scheduler Active Set	5688	Set1 (1)	
Boundary1-2	Scheduler Boundary 1-2	5689	0.00	
Boundary2-3	Scheduler Boundary 2-3	5690	0.00	
ProportionalBand	Proportional Band	5691	30.00	
IntegralTime	Integral Time	5692	360.00	
DerivativeTime	Derivative Time	5693	60.00	
RelCh2Gain	Relative Cool/Ch2 Gain	5694	1.00	
CutbackHigh	Cutback High	5695	Auto (0)	
CutbackLow	Cutback Low	5696	Auto (0)	
ManualReset	Manual Reset	5697	0.00	
LoopBreakTime	Loop Break Time	5698	100.00	
OutputLimit	Gain Scheduled Output Lo Limit	5716	-100.00	

Drag and drop the parameter(s) which are required to be read only in Supervisor level when OEM security is enabled.

In this example the parameter Loop1 Proportional band.

Name	Description	Address	Value	Wired From
Parameter1	Parameter that is to be read only	4756	50332678	Loop.1.PID.ProportionalBand
Parameter2	Parameter that is to be read only	4757	4294967295	(not wired)
Parameter3	Parameter that is to be read only	4758	4294967295	(not wired)
Parameter4	Parameter that is to be read only	4759	4294967295	(not wired)
Parameter5	Parameter that is to be read only	4760	4294967295	(not wired)
Parameter6	Parameter that is to be read only	4761	4294967295	(not wired)
Parameter7	Parameter that is to be read only	4762	4294967295	(not wired)
Parameter8	Parameter that is to be read only	4763	4294967295	(not wired)
Parameter9	Parameter that is to be read only	4764	4294967295	(not wired)
Parameter10	Parameter that is to be read only	4765	4294967295	(not wired)
Parameter11	Parameter that is to be read only	4766	4294967295	(not wired)
Parameter12	Parameter that is to be read only	4767	4294967295	(not wired)

Instrument.OEMSupervisorList - 100 parameters

To Enable OEM Security

In 'OEMEntry' enter the security code. This is the same code as entered in Engineer level in 'OEMPass', "Security menu" on page 98. The 'OEMStatus' parameter will change to 'Locked'.

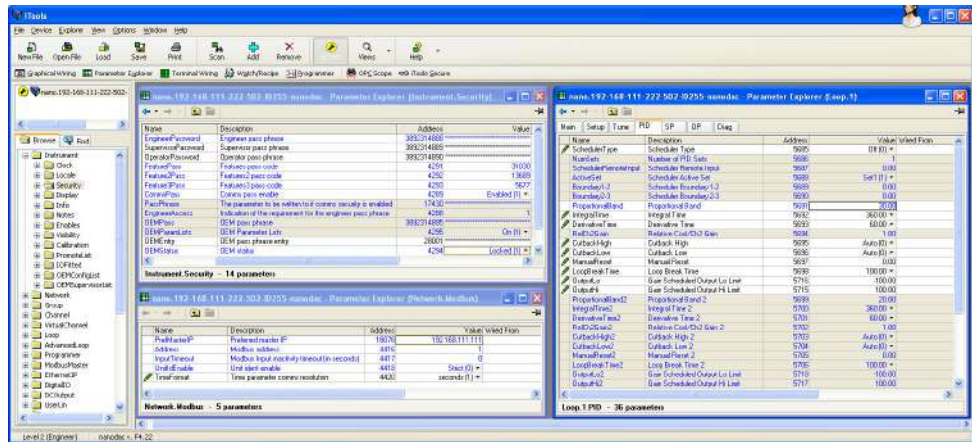

Figure 192 OEMStatus parameter set to 'Locked'

As in Figure 192 above, the parameter 'TimeFormat' is alterable in Engineer level and the parameter 'Loop1 Proportional Band' is locked when OEM security is enabled.

User Wiring

User wiring, created from the instrument front panel, allows parameters to be wired together so that, for example, a counter can be configured to be incremented when an alarm goes active. This can be used as an alternative to iTools.

This section is presented as two examples that show the general techniques used to create and delete wires from the instrument user interface.

Notes:

1. These examples refer to Channel Configuration and to Virtual Channel configuration, descriptions of which are to be found in "Input Channel Configuration" on page 123 and "Virtual Channel Configuration" on page 133, respectively.
2. The destination parameter field has a small green triangle at the top right corner to indicate that it has a wire routed to it.

3A/3B (Relay)

Drive Relay Example

To drive the relay whose terminal contacts are 3A/3B, whilst the temperature being measured by Channel 2 exceeds 30°C. For this example Channel 2 alarm 1 and a hysteresis of 4°C will be used.

1. In channel 2, Alarm 1 page (see note), set the following parameters:

Type: Abs. High
 Threshold: 30
 Hysteresis: 4
 Latch: None
 Block: Off
 Dwell:00:00:00
 Acknowledge: No

Channel. 2.Alarm1	
Type	Abs Hi
Status	Active Not ackd
Threshold	30.0
Hysteresis	4.0
Latch	None
Block	Off
Dwell	00:00:00
Acknowledge	No
Active	Yes
Inactive	No
N.acknowledged	Yes
Acknowledgement	No
Inhibit	X

Figure 193 Channel 2, Alarm 1 set up

Note: The channel alarm areas of configuration become accessible only once the channel with which they are associated has been configured with a suitable 'Type' ("Channel Main" on page 123).

2. Highlight the 'Active' field, and press and hold the scroll button for a few seconds, until the top level User Wiring page appears. The name of the selected parameter appears at the top of the page. Any already existing wires from this parameter would appear below the 'Add new wire' area.
3. With 'Add new wire' highlighted operate the scroll button.
4. Use the down arrow to highlight 'Digital I/O' and press the scroll button.
5. Use the down arrow to highlight '3A3B (Relay)' and press the scroll button.
6. Use the down arrow to highlight 'PV' and press the scroll button. (If this parameter is already wired-to, the 'wired' symbol appears to the left of the parameter).
7. When the confirmation window appears, use the up or down arrow to highlight 'Ok', then operate the scroll button again.
8. The top level user wiring page reappears, showing the destination parameter.



Wire removal

At the top level user wiring page, use the up and down arrow buttons to highlight the wire to be deleted, and operate the scroll key. In the 'Delete Wire' confirmation window, highlight 'Ok' and operate the scroll key again. The wire is deleted without further confirmation.

Counter Example

This example shows how to set up a counter to be incremented each time Channel 1 Alarm 1 becomes active, and reset each time channel 2, alarm 1 is acknowledged. For this example, Virtual Channel 3 will be configured as the counter, with a preset value of 0.

1. At Channel.1.Main, set:
 - Type = test
 - Test Signal = Sine 4 min.
 - Scale Low = 0
 - Scale High = 100
2. At Channel.1.Alarm1, set:
 - Type = Abs Hi
 - Threshold = 50
 - Latch = None
3. At Channel.2.Main, set:
 - Type = Test
 - Test Signal = Sine 40 min.
 - Scale Low = 0
 - Scale High = 100
4. At Channel.2.Alarm 1, set:
 - Type = Abs Hi
 - Threshold = 90
 - Latch = Manual
5. At Virtual Channel.3.Main, set:
 - Type = Counter
 - Operation = On
 - Input = 1

All the other parameters can be left at their defaults.

6. Still at Virtual Channel 3 (Main), use the up/down arrow buttons to highlight 'Trigger'. Press and hold the scroll key. The top level User Wiring page appears, this time with a 'From Source' tab as well as the 'To Destination' tab of example 1. This is because this parameter is read/write, whereas Alarm Active is read only (i.e. its value may be read but not changed).
7. Use the up (or down) arrow button to select the 'From Source' tab.

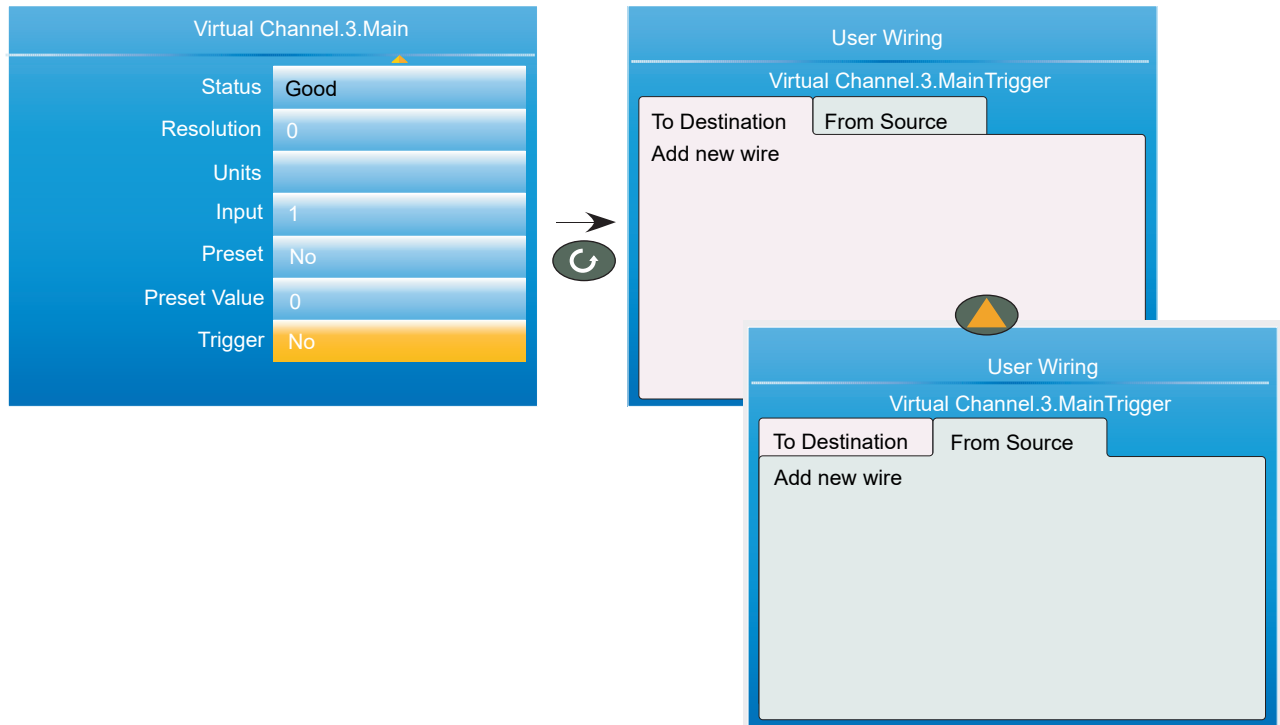

Figure 194 Wiring a counter: part 1

8. Operate the Scroll key to highlight 'Add new wire', then again to display the top level parameter list.
9. Use the down arrow button to highlight 'Channel' and operate the scroll button.
10. Operate the scroll button to select '1'.
11. Highlight 'Alarm 1' and operate the scroll button.
12. Use the down arrow button to highlight 'Active'. Operate the Scroll button again, and create the new wire.
13. Use the Page button twice to return to the Virtual Channel 3 menu.

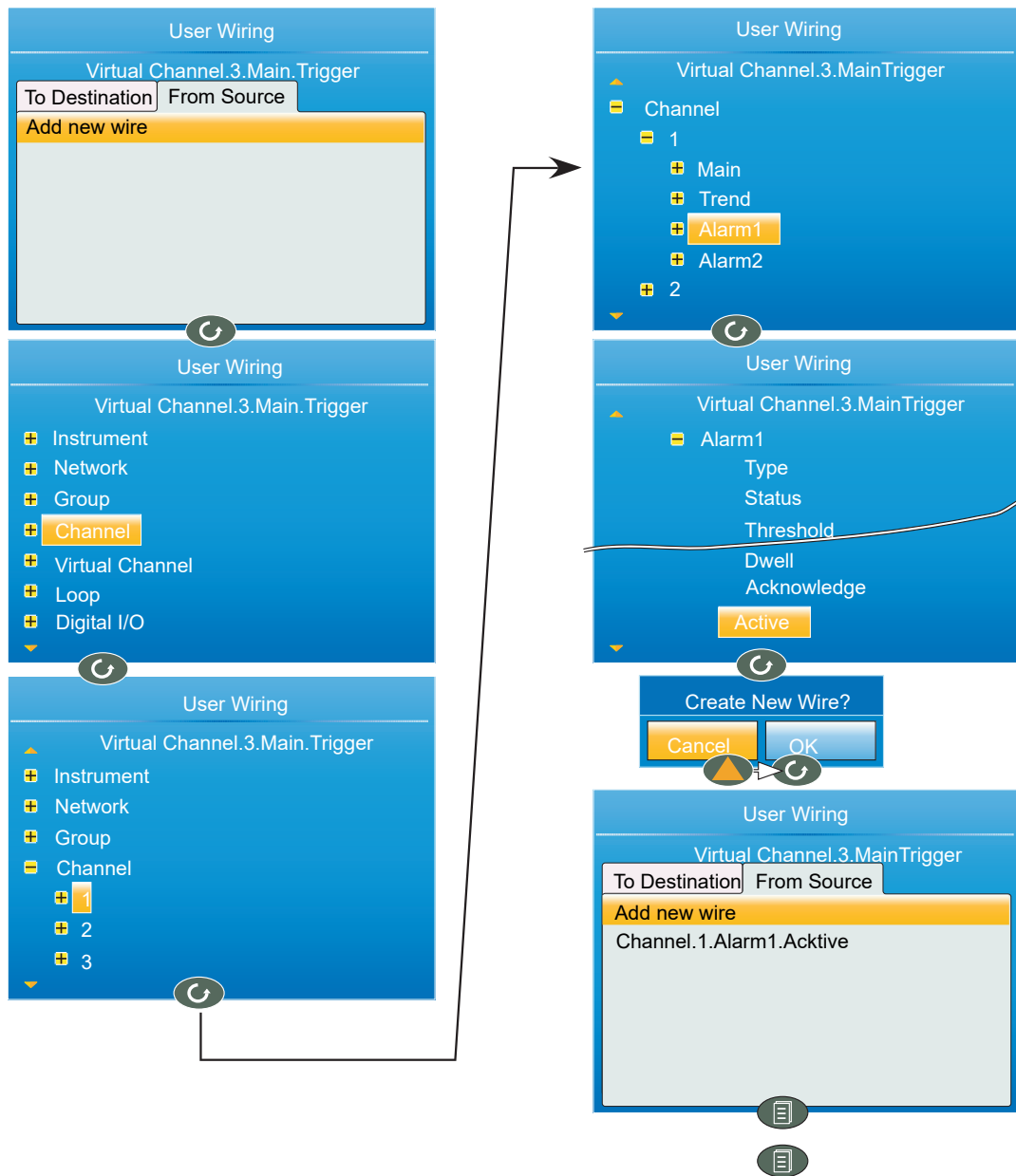

Figure 195 Wiring a counter: part 2

14. At Virtual Channel.3.Main, use the down arrow to select 'Preset'. Press and hold the scroll key. The top level User Wiring page appears.
15. Use the up (or down) arrow button to select the 'From Source' tab, if not already selected.
16. Operate the Scroll key to highlight 'Add new wire', then again to display the top level parameter list.
17. Use the down arrow button to highlight 'Channel' and operate the scroll button.
18. Use the down arrow button to highlight '2' and operate the scroll button.
19. Highlight 'Alarm 1' and operate the scroll button.
20. Use the down arrow button to highlight 'Acknowledgement' (not 'Acknowledge'). Operate the Scroll button again, and create the new wire.

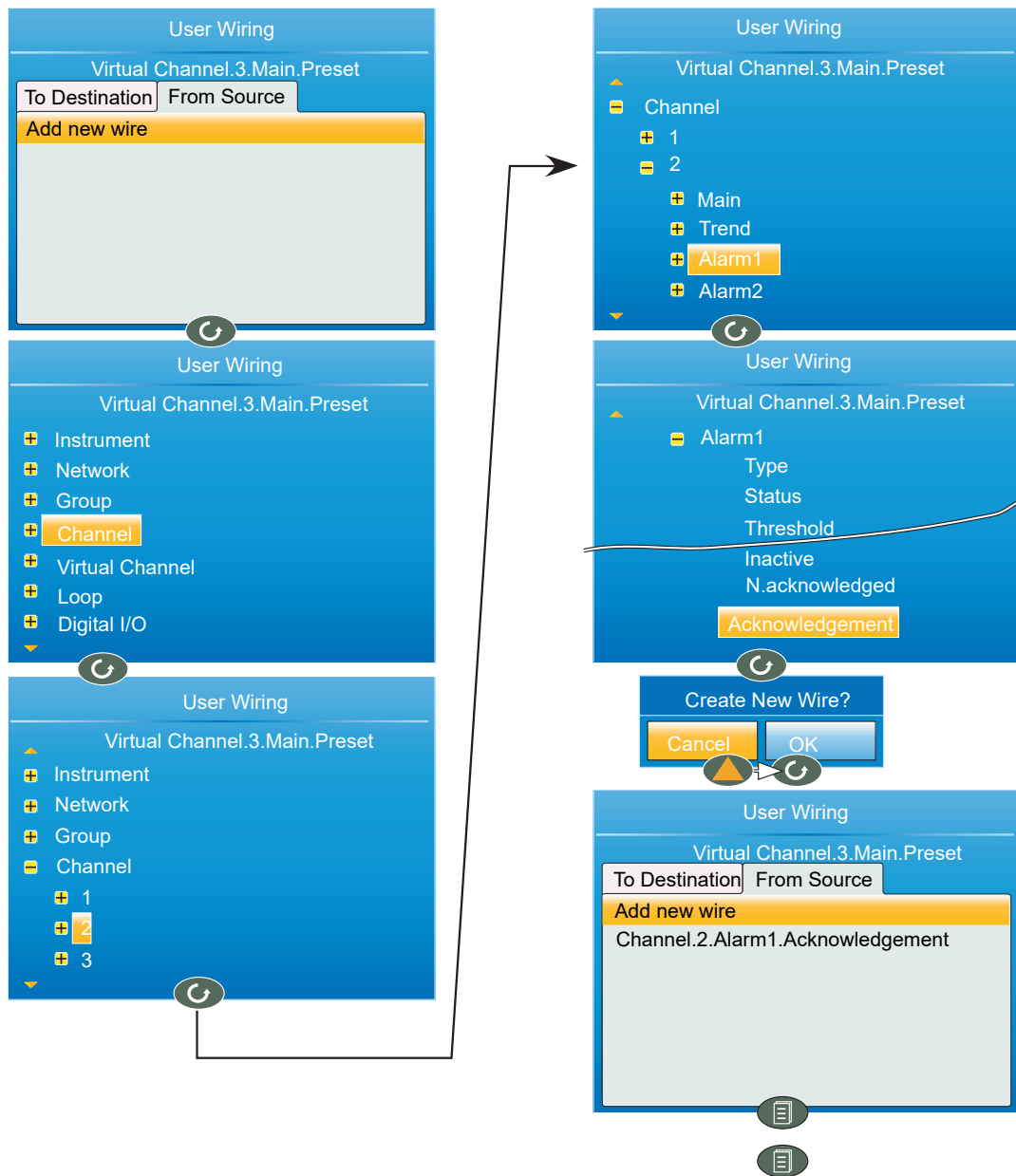

Figure 196 Wiring a counter: part 3

USB Devices

The devices listed below can be plugged into the USB connector at the back of the instrument, providing that the maximum current required is less than 100mA.

1. Memory Stick
2. Barcode reader
3. Keyboard

Notes:

1. See "'Symbols" on page 16' in the Safety Notes section of the manual.
2. See "Recorder Specification" on page 389 for the USB port specification.
3. The use of USB hubs is not supported by this instrument.

Memory Stick

The use of the memory stick as an archiving device, or to facilitate software upgrades is well documented in the relevant sections of this manual.

Barcode Reader

If 'USB Auto Scan is set to 'Yes' in Display Configuration ("Display configuration" on page 94) then, with the barcode reader plugged into the USB port, the scanned data input stream is packaged into a general message displayed on the vertical trend and message displays and included in the .uhh history file. The format of the message is: DD/MM/YY HH:MM:SS 123--13 (where 123--13 represents the ASCII data read from the barcode).

Note: The message and the vertical trend displays do not auto refresh so the display is not automatically updated when the barcode scanner is used. The message is, however, updated in the message list.

If 'USB auto Scan' is set to 'No, the ASCII data read from the barcode is displayed as a message ready for editing prior to being sent to the display etc. [Figure 197](#) shows an example.

Note: The barcode reader must be configured to use a carriage return (decimal 13) terminating character.

Edit the message, if required, then use the page, arrow and scroll pushbuttons to confirm the message.

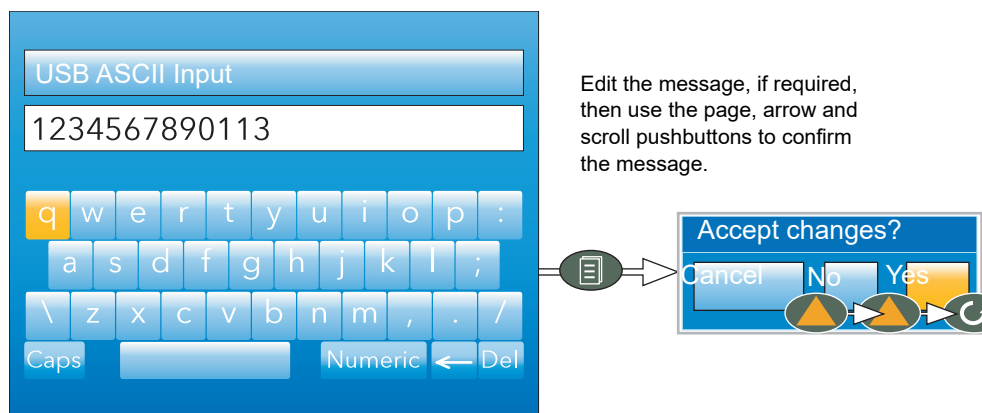

USB Keyboard

A QWERTY keyboard may be plugged into the rear USB port to act in parallel with the virtual keyboard ("Text Entry" on page 89). The editing keys listed below are supported in addition to the standard alpha-numeric characters.

Left arrow	Moves the cursor leftwards through the text string (stops at the start of the string).
Right arrow	Moves the cursor rightwards through the text string (stops at the end of the string).
Backspace	Deletes the character immediately to the left of the cursor.
Delete	Removes the character immediately to the right of the cursor.
End	Moves the cursor to the end of the string.
Home	Moves the cursor to the start of the string.
Insert	Highlights the entire string, for overwriting.
Esc	Exit without saving changes.

Appendix A: Technical Specification

Installation Category and Pollution Degree

This product has been designed to conform to BS EN61010 installation category II and pollution degree 2, defined as follows:

Installation Category II

The rated impulse voltage for equipment on nominal 230V mains is 2500V.

Pollution Degree 2

Normally, only non-conductive pollution occurs. Occasionally, however, a temporary conductivity caused by condensation shall be expected.

Recorder Specification

I/O types

Analogue i/p: Four (eight if dual input option fitted)
 Digital i/p: Digital (logic) o/p Two See Table A1 for options
 Relay o/p: See Table A1 for options
 DC output: See Table A1 for options

Features :

- CSV archive format
- EtherNet/IP (Option)
- File transfer protocol (FTP)
- Messages
- Modbus Master (Option)
- Modbus TCP slave
- Set point programmer (option)
- uhh (history file) archiving
- USB port at rear of instrument
- User linearisation tables (four)
- Two control loops (optional)
- Advanced Loop (optional)
- Zirconia probe support (optional)
- 15 Virtual channels (each configurable as maths, totaliser or counter).
- 30 Virtual channels if Modbus Master or EtherNet/IP options fitted (no alarms on virtual channels 16 to 30)

Table 7: Table A1 Output options

IO1	OP2	OP3	OP4	OP5	
L	R	R	R	R	← Default
L	R	D	R	R	← Options
L	L	R	R	R	
R	D	D	R	R	
D	D	D	R	R	
L	L	D	R	R	

L = Logic output; R = Relay; D = DC output
 OP4 and OP5 share Common terminals.

Environmental performance

Ambient temperature range	Operating: 0 to 55°C Storage: -20 to +70°C
Humidity range	Operating: 5% to 85% RH non condensing storage: 5% to 85% RH non condensing
Protection Front panel	(Standard): IP65 Front panel (Wash down): IP66, NEMA12 Behind panel: IP10 (International)
Shock/Vibration	To BS EN61131-2 (5 to 150 Hz. at 1g; 1 octave per min.)
Altitude	<2000 metres
Atmosphere	Not suitable for use in explosive or corrosive atmospheres.
Electrical safety	BS EN61010-1 (Installation category II; Pollution degree 2)
Electromagnetic compatibility	
Emissions (standard units):	BS EN61326 Class B - Light industrial.
Emissions (Low voltage option):	BS EN61326 Class A - Heavy industrial
Immunity	BS EN61326 Industrial

Other approvals and compliance details

General:	CE and cUL, EN61010
PV input	AMS2750E compliant
RoHS	EU; China
Packaging	BS EN61131-2 section 2.1.3.3.

Physical

Panel mounting:	1/4 DIN
Weight:	0.44kg (15.52 oz.)
Panel cutout dimension:	92mm x 92mm (both -0.0 +0.8) or 3.62 in x 3.62 in (both -0.00 +0.03 in) (Figure 2)
Depth behind panel:	90mm (3.54in) (Figure 2) excluding wiring.

Operator interface

Display:	3.5" TFT colour display (320 pixels wide x 240 pixels high)
Controls:	Four navigation pushbuttons below the display screen (Page, Scroll, Lower and Raise)

Power requirements

Supply voltage	Standard: 100 to 230Vac ± 15% at 48 to 62Hz. Low voltage option: 24Vac (+10% - 15%), at 48 to 62Hz, or 24Vdc (+20% -15%)
Power dissipation:	9W
Fuse type:	None
Interrupt protection	Standard: Holdup >20ms at 85V RMS supply voltage. Low voltage option: Holdup >20ms at 20.4V RMS supply voltage.

Battery backup

Stored data:	Time, date.
Support time (for real-time clock):	Minimum of 1 year with unit unpowered.
Replacement period:	Three years typical
Type:	poly-carbonmonofluoride / lithium (BR2330) (PA260195)

Ethernet communications

Type:	10/100baseT Ethernet (IEEE802.3)
Protocols:	Modbus TCP/IP slave, FTP, DHCP
Cable type:	Category 5
Maximum length:	100metres (110 yards)
Termination:	RJ45. Green LED illuminated = link connected; Amber LED flashing shows link activity.

USB port

Number of ports:	One at rear of instrument
Standard:	USB1.1
Transmission speeds:	1.5Mbits/sec (low speed device)
Maximum current:	<100mA
Peripherals supported:	Memory stick (8GB max), Bar code reader, QWERTY keyboard

Update/Archive rates

Sample rate (input/output) 8Hz (4Hz for digital inputs) (4Hz for dual input channels)
Trend update 8Hz max. Archive sample value Latest value at archive time Display
value Latest value at display update time.

Analogue Input Specification

General

Number of analogue inputs	Four
Input types	Standard: Optional: dc Volts, dc mV, dc mA (external shunt required), thermocouple, RTD (2-wire and 3-wire), digital (contact closure). dual mA, dual mV, dual thermocouple.
Input type mix	Freely configurable
Sample rate	8Hz (125ms)
Conversion method	16 bit delta sigma.
Input ranges	See below.
Mains rejection (48 to 62Hz)	
Series mode:	>95dB
Common mode:	>179dB
Common mode voltage	250Vac max.
Series mode voltage	280mV at lowest range; 5V peak-to-peak, at highest range.
Input impedance	See relevant Range specification, below.
Overvoltage protection	
Continuous:	± 30V RMS
Transient (<1ms):	±200V pk-pk between terminals.
Sensor break detection	Type ac sensor break on each input giving quick response with no associated dc errors.
Recognition time:	<3 secs.
Minimum break resistance:	40mV, 80mV ranges: 5kΩ; other ranges: 12.5kΩ
Shunt (mA inputs only) Values	1Ω to 1kΩ, mounted externally.
additional error due to shunt:	0.1% input
Isolation Channel to channel:	300V RMS or dc (single insulation)
Channel to common electronics:	300V RMS or dc (single insulation)
Channel to ground:	300V RMS or dc (single insulation)
Dielectric strength	Test: BS EN61010, 1 minute type test
Channel to channel:	2500Vac
Channel to ground:	1500Vac

DC input ranges

Ranges	40mv, 80mV, 2V; 10V (-4.0 to +10V)
40mV Range	Range: -40mV to + 40mV
Resolution	1.9µV (unfiltered)
Measurement noise:	1.0µV peak-to-peak with 1.6s input filter
Linearity error:	0.003% (best fit straight line)
Calibration error:	±4.6µV ±0.053% of measurement at 25°C ambient
Temperature coefficient:	±0.2µV/°C ±13ppm/°C of measurement from 25°C ambient
Input leakage current:	±14nA
Input resistance:	100MΩ
80mV Range	Range: -80mV to + 80mV
Resolution	3.2µV (unfiltered)
Measurement noise:	3.3µV peak-to-peak with 1.6s input filter
Linearity error:	0.003% (best fit straight line)
Calibration error:	±7.5µV ±0.052% of measurement at 25°C ambient
Temperature coefficient:	±0.2µV/°C ± 13ppm/°C of measurement from 25°C ambient
Input leakage current:	±14nA
Input resistance:	100MΩ
2V Range	Range: ±2V
Resolution	82µV
Measurement noise:	90µV peak-to-peak with 1.6s input filter
Linearity error:	0.003% (best fit straight line)
Calibration error:	±420µV ±0.044% of measurement at 25°C ambient
Temperature coefficient:	±125µV/°C ±13ppm/°C of measurement from 25°C ambient
Input leakage current:	±14nA
Input resistance:	100MΩ
10V Range	Range: -3V to +10V
Resolution	500µV
Measurement noise:	550µV peak-to-peak with 1.6s input filter
Linearity error:	0.007% (best fit straight line) for zero source resistance. Add 0.003% for each 10Ω source and lead resistance
Calibration error:	±1.5mV ±0.063% measurement at 25°C ambient
Temperature coefficient:	±66µV/°C ± 45ppm/°C of measurement from 25°C ambient
Input resistance:	62.5kΩ for input voltages > 5.6V. 667kΩ for input ranges < 5.6V.

Note: The 10V range is not available for dual input channels

Resistance input ranges

Temperature scale:	ITS90
RTD Types, ranges and accuracies:	See table
Maximum source current:	200µA
Resistance input figures	
Range:	0 to 400Ω (-200 to +850°C)
Resolution:	0.05°C
Measurement noise:	0.05°C peak-peak with 1.6s input filter
Linearity error:	0.0033% (best fit straight line)
Calibration error:	±0.31°C ±0.023% of measurement in °C at 25°C ambient
Temperature coefficient:	±0.01°C/°C ±25ppm/°C measurement in °C from 25°C ambient
Lead resistance	0 to 22Ω matched lead resistances
Bulb current:	200µA nominal

Table 8: RTD type details

RTD type	Overall range °C	Standard	Max. linearisation error
Cu10	-20 to + 400	General electric Co.	0.02°C
Cu53	-70 to + 200	RC21-4-1966	<0.01°C
JPT100	-220 to + 630	JIS C1604:1989	0.01°C
Ni100	-60 to + 250	DIN43760:1987	0.01°C
Ni120	-50 to + 170	DIN43760:1987	0.01°C
Pt100	-200 to + 850	IEC751	0.01°C
Pt100A	-200 to + 600	Eurotherm Recorders SA	0.09°C

Thermocouple data

Temperature scale: ITS90
 CJCTypes: Off, internal, external, remote.
 Remote CJC source: Any input channel
 Internal CJC error: <1°C max, with instrument at 25°C
 Internal CJC rejection ratio: 40:1 from 25°C
 Upscale/downscale drive: High, low or none independently configurable for each channel's sensor break detection.
 Types, ranges and accuracies: See Figure A.2

Table 9: Thermocouple types, ranges and accuracies

T/C type	Overall range (°C)	Standard	Max. linearisation error
B	0 to + 1820	IEC584.1	0 to 400°C = 1.7°C 400 to 1820°C = 0.03°C
C	0 to + 2300	Hoskins	0.12°C
D	0 to + 2495	Hoskins	0.08°C
E	-270 to + 1000	IEC584.1	0.03°C
G2	0 to + 2315	Hoskins	0.07°C
J	-210 to + 1200	IEC584.1	0.02°C
K	-270 to + 1372	IEC584.1	0.04°C
L	-200 to + 900	DIN43710:1985 (to IPTS68)	0.02°C
N	-270 to + 1300	IEC584.1	0.04°C
R	-50 to + 1768	IEC584.1	0.04°C
S	-50 to + 1768	IEC584.1	0.04°C
T	-270 to + 400	IEC584.1	0.02°C
U	-200 to + 600	DIN43710:1985	0.08°C
NiMo/Ni Co	-50 to + 1410	ASTM E1751-95	0.06°C
Platinel	0 to + 1370	Engelhard	0.02°C
Mi/NiMo	0 to + 1406	Ipsen	0.14°C
Pt20%Rh/ Pt40% Rh	0 to + 1888	ASTM E1751-95	0.07°C

Relay and Logic I/O Specification

OP1, OP2, OP3, OP4 and OP5 logic input, logic output and relay specification.

Active (current on) current sourcing logic output

Voltage output
across terminals: +11V min; +13V max.
Short circuit output current: 6mA min. (steady state); 44mA max. (switch current)

Inactive (current off) current sourcing logic output (OP1 or OP2 only)

Voltage output
across terminals: 0V (min.); 300mV (max.)
Output source leakage
current into short circuit: 0µA (min.); 100µA max.

Active (current on) contact closure sourcing logic input (OP1 and OP2 only)

Input current
Input at 12V: 0mA (min.); 44mA (max.)
input at 0V: 6mA min. (steady state); 44mA max. (switch current)
Open circuit input voltage: 11V (min.); 13V (max.)
Open circuit (inactive)
resistance: 500Ω (min.); ∞ (max.)
Closed
circuit (active) resistance: 0Ω (min.); 150Ω (max.)

Relay contacts (OP1, OP2 and OP3) - AgCdO

Contact
switching power (resistive): Max: 2A at 230V RMS ±15%; Min: 100mA @ 12V.
Maximum
current through terminals: 2A
Estimated mechanical life: >10,000,000 operations

Relay contacts (OP4 and OP5) - AgNi

Contact
switching power (resistive): Max: 1A at 230V RMS ±15%
Min: 5mA @ 5V.
Maximum
current through terminals: 1A
Estimated mechanical life: >10,000,000 operations

Digital Inputs

DigInA, DigInB, contact closure logic input

Contact closure

Short circuit	
sensing current (source):	5.5mA (min.); 6.5mA (max.)
Open circuit	
(inactive) resistance:	600 Ω (min.); ∞ (max.)
Closed circuit	
(active) resistance:	0 Ω (min.); 300 Ω (max.)
Maximum frequency:	8Hz
Minimum pulse width:	62.5ms

DC Outputs

OP1, OP2, OP3 DC analogue outputs

Current outputs (OP1, OP2 and OP3)

Output ranges: Configurable within 0 to 20mA
Load resistance: 500Ω Max.
Calibration accuracy: $<\pm 100\mu\text{A} \pm 1\%$ of reading

Voltage outputs (OP3 only)

Output range: Configurable within 0 to 10V
Output impedance: 500Ω Min.
Calibration accuracy: $<\pm 50\text{mV} \pm 1\%$ of reading

General

Isolation: 300Vac double insulated from instrument and other I/O
Resolution: >11 bits
Thermal drift: $<100\text{ppm}/^\circ\text{C}$

Blocks Supported

'Toolkit' Blocks

BCD input
Eight-input logic
Eight input multiplexer
Timers
Two-input logic
Two-input maths
User values

Application Blocks

Humidity
Steriliser
Zirconia

Appendix B: Control Loops

Note: See "Loop Option Configuration" on page 142 and "Advanced Loop Configuration" on page 152 for Loop configuration details.

Introduction

With this recorder, two control loops are available, each loop containing two outputs (Channel 1 and Channel 2) which can be individually configured for PID, On/Off or valve position. For temperature control, channel 1 is normally configured for heating and channel 2 for cooling.

Example (Heat Only)

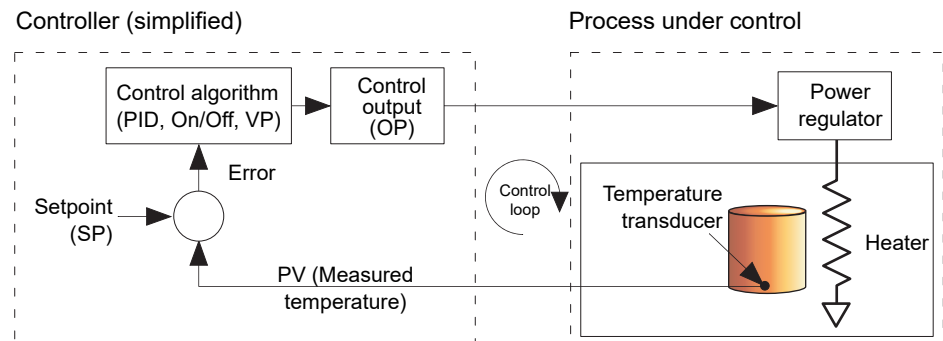

Figure 198 Control loop example

The measured temperature (process variable, or 'PV') is connected to the input of the controller, where it is compared with the 'Setpoint' (SP) (the target temperature). If there is a difference between the PV and the SP, the controller calculates and outputs a heating demand. This output is applied to the process heating device, which in turn causes a change in the PV in a direction intended to result in a zero error.

Control Loop Definitions

Auto/Manual

In manual mode, if 'On/Off' control is configured, the output power may be edited by the user but the only power values allowed are: +100% (heat on; cool off) for positive user entries, 0% (heat off; cool off) for zero entry or -100%. (heat off; cool on) for negative entries.

In manual mode, for 'PID' control the output may be edited between +100% and (if 'cool' is configured), -100%. The actual output value is subject to limiting and output rate limit.

In manual mode, for valve position control, the up and down arrow buttons directly control (nudge) the raise and lower relay outputs respectively. It is also possible to control the valve by sending nudge commands over a serial link, or by software wiring from a suitable parameter. A single nudge command moves the valve by 1 minimum on time; longer nudge demands produce longer valve movements. See "Valve nudge" on page 429 for more details.

If sensor break occurs while the controller is in automatic the controller outputs the sensor break output power. In such a case the user can switch to manual control and edit the output power. On returning to automatic control, the controller checks again for sensor break.

If autotune is enabled while in manual mode, the autotune remains in a reset state such that when the user puts the controller into automatic control the autotune starts.

Types of Control Loop

On/Off control

This form of control turns heating power on when the process value is below the setpoint, and turns it off when it is above the setpoint (see also [Figure 217](#)). If cooling is configured, it has its own relay which operates in a similar way. In Direct Acting mode, the behaviour is inverted. On/off is suitable for controlling switching devices such as relays.

Because of the thermal inertia of the load, a certain amount of oscillation will take place, and this can affect the quality of the product. For this reason, On/Off control is not recommended for critical applications.

Depending on the nature of the process being controlled, some hysteresis may have to be included to prevent continuous operation or chatter in the controlling device.

PID Control

Also known as 'three term control', this type of control continuously adjusts the output demand, according to a set of rules, in order to control the process as closely as possible to requirements. PID provides more stable control than On/Off control but is more complex to set up as the parameters must match the characteristics of the process under control.

The three major parameters are: Proportional band (PB), Integral time (Ti) and Derivative time (Td) and the output from the controller is the sum of these three terms. This output is a function of the size and duration of the error value and the rate-of-change of the process value.

It is possible to disable the integral and/or derivative terms and control on proportional only, on proportional plus integral (PI) or proportional plus derivative (PD).

PI control is often used when the PV is noisy and/or subject to rapid variations, where derivative action would cause the output power to fluctuate wildly.

Proportional Band

The proportional band (PB) delivers an output which is proportional to the size of the error signal. It is the range over which the output power is continuously adjustable in a linear fashion from 0% to 100% (for a heat only controller). Below the proportional band the output is full on (100%), above the proportional band the output is full off (0%) as shown in [Figure 199](#).

The width of the proportional band determines the magnitude of the response to the error. If PB is too narrow (high gain) the system oscillates; if it is too wide (low gain) control is sluggish. The ideal situation is when the proportional band is as narrow as possible without causing oscillation.

[Figure 199](#) also shows the effect of narrowing proportional band to the point of oscillation. A wide proportional band results in straight line control but with an appreciable initial error between setpoint and actual temperature. As the band is narrowed the temperature gets closer to setpoint until eventually, it becomes unstable.

The proportional band may be set in engineering units or as a percentage of the controller range.

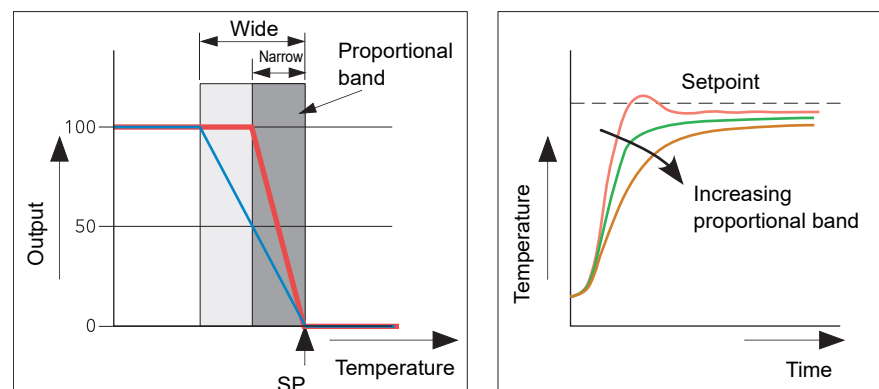

Figure 199 Proportional band action (reverse acting)

Integral Term

In a proportional only controller, as seen in the previous section, an error must exist between setpoint and PV in order for the controller to deliver power. Integral is used to achieve zero steady state control error.

The integral term slowly modifies the output level as a result of any error between setpoint and measured value. If the measured value is below setpoint the integral action gradually increases the output in an attempt to correct the error. If it is above setpoint integral action gradually decreases the output or increases the cooling power to correct the error.

Figure 200 shows proportional plus integral action.

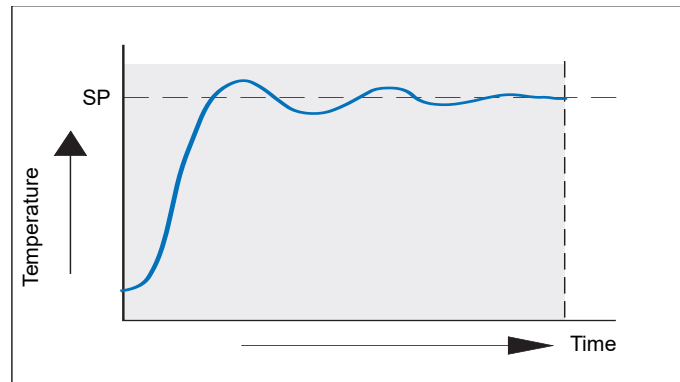

Figure 200 Proportional + Integral Control

The integral term is set in seconds. The longer the integral time constant, the more slowly the output is modified and the more sluggish the response. Too small an integral time causes the process to overshoot, and perhaps to start oscillating. The integral action may be disabled by setting its value to Off.

Derivative Term

Derivative (or rate) action provides a sudden change in output linked to the rate of change in error, whether this is caused by PV alone (derivative on PV) or by a change in the SP as well (derivative on error selection). If the measured value falls quickly, derivative provides a large change in output in an attempt to correct the perturbation before it goes too far. It is most beneficial in recovering from small perturbations.

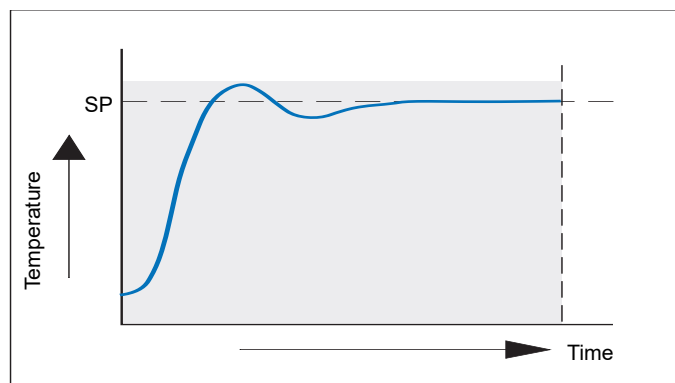

Figure 201 Proportional + Integral + Derivative Action

Derivative is used to improve the performance of the loop. There are, however, situations where derivative may be the cause of instability. For example, if the PV is noisy, then derivative can amplify that noise and cause excessive output changes, in these situations it is often better to disable the derivative and re-tune the loop.

Derivative should not be used to curb overshoot in situations when the output is saturated at Op High or Op Low for extended periods, such as process start up, since to do so degrades the steady state performance of the system. Overshoot inhibition is best left to the approach control parameters, High and Low Cutback.

If Derivative is set to Off, no derivative action will be applied.

Derivative can be calculated on change of PV or change of Error. If configured on error, then changes in the setpoint will be transmitted to the output. For applications such as furnace temperature control, it is common practice to select Derivative on PV to prevent thermal shock caused by a sudden change of output as a result of a change in setpoint.

Motorised valve control

Designed specifically for driving motorised valves this type of control can operate in 'Unbounded' mode (VPU) or 'Bounded' mode (VPB). Relay outputs are used to drive the valve motor.

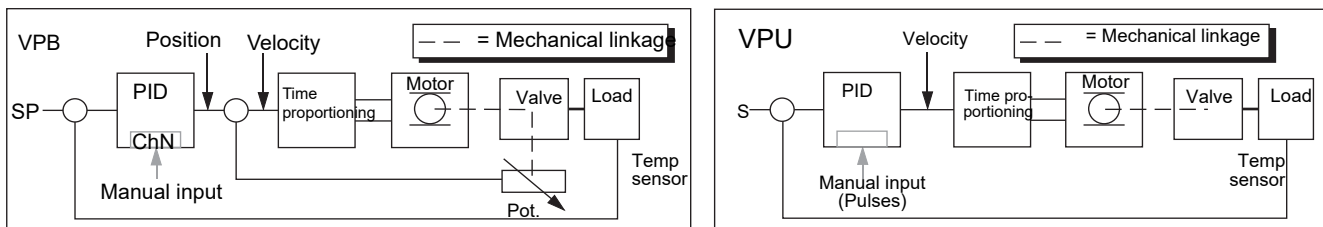

Figure 202 VPB and VPU comparison

Unbounded valve positioning (VPU) does not require a position feedback potentiometer in order to operate because it controls directly the direction and velocity of the movement of the valve in order to minimise the error between the setpoint (SP) and the process variable (PV). Control is performed by delivering a 'raise' or 'lower' pulse to control the velocity of the valve in response to the control demand signal.

Bounded VP (VPB) control uses PID (or any other combination of the three terms) to set a required valve position. A feedback potentiometer linked to the valve provides a signal giving actual valve position. This allows the control loop to calculate the difference between required and actual position dynamically, and adjust control output accordingly. Control is performed by delivering a 'raise' or 'lower' pulse to adjust the valve position.

Manual Mode

Bounded VP controls in manual mode because the inner positional loop is still running against the potentiometer feedback, so it is operating as a position loop.

In boundless mode the algorithm is a velocity mode positioner. When manual is selected then the up and down arrow produce +100% or –100% velocity respectively for the duration of the key press.

In boundless mode it is essential that the motor travel time is set accurately in order to allow the integral time to calculate correctly. Motor travel time is defined as (valve fully open – valve fully closed). This is not necessarily the time printed on the motor since, if mechanical stops have been set on the motor, the travel time of the valve may be different.

Every time the valve is driven to its end stops the algorithm is reset to 0% or 100% to compensate for any changes which may occur due to wear in linkages or other mechanical parts.

This technique makes boundless VP look like a positional loop in manual even though it is not. This enables combinations of heating and cooling e.g. PID heat, VPU cool with manual mode working as expected.

Motorised Valve Output Connections

The loop output which has been configured as valve position can be wired to the PV input of one of the pairs of relays 2A2B/3A3B or 4AC/5AC which has been configured as Type = 'Valve Raise'. Only one relay input needs to be wired as the other relay of the pair will be automatically set to 'Valve Lower'. For example, if Loop 1 Channel 1 output is wired to Relay 2A2B and the 'Type' is configured as 'Valve Raise' then the Type for Relay 3A3B will be 'Valve Lower'.

Loop Parameters

Relative cool gain (R2G)

This is the gain of channel 2 control output, relative to the channel 1 control output and is used to compensate for the different quantities of power available to heat and to cool a process. For example, water cooling applications might require a relative cool gain of 0.25 because cooling is four times greater than the heating process at the operating temperature.

By default, this parameter is set automatically when an Autotune is performed, but setting the Tune menu parameter (see "Tune menu parameters" on page 145) 'AT.R2G' to 'No' causes the R2G value(s) entered in the PID menu (see "PID menu parameters" on page 145) to be used instead.

High and Low cutback

Cutback high 'CBH' and Cutback low 'CBL' are values that modify the amount of overshoot, or undershoot, that occurs during large step changes in PV under start-up conditions, for example. They are independent of the PID terms which means that the PID terms can be set for optimal steady state response and the cutback parameters used to modify any overshoot which may be present.

Cutback involves moving the proportional band towards the cutback point nearest the measured value whenever the latter is outside the proportional band and the power is saturated (at 0 or 100% for a heat only controller). The proportional band moves downscale to the lower cutback point and waits for the measured value to enter it. It then escorts the measured value with full PID control to the setpoint. In some cases it can cause a 'dip' in the measured value as it approaches setpoint as shown in [Figure 203](#) but generally decreases the time needed to bring the process into operation.

The action described above is reversed for falling temperature.

If cutback is set to Auto the cutback values are automatically configured to $3 \times PB$.

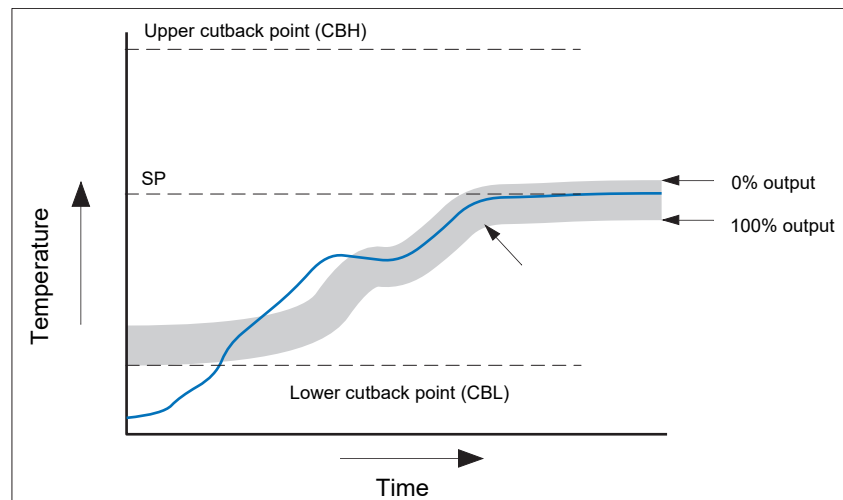

Figure 203 Cutback operation

Briefly, if $PV < CBL$ then the output is set to its maximum.

If $PV > CBH$, then the output is set to its minimum

If PV lies within the range $CBH-CBL$, then PID calculations take control.

Manual Reset

With PID control, the integral term automatically removes the steady state error from the setpoint. With PD control, the integral term is set to 'OFF', and the measured value will not settle precisely at the setpoint. The Manual Reset parameter (MR in the PID menu - see "PID menu parameters" on page 145) represents the value of the power output that will be delivered when the error is zero. This value must be set manually in order to remove the steady state error.

Integral Hold

If 'Integral Hold' (Main menu - "Main menu parameters" on page 143) is set to 'Yes', the integral component of the PID calculation is frozen, that is, it holds its current value but does not integrate any disturbances in the plant. This is equivalent to switching into PD control with a manual reset value preconfigured.

Integral Hold may be used, in a situation where the loop is expected to open. For example, it may be necessary to turn heaters off for a short period or to switch into manual at low power. In this case it may be advantageous to wire Integral Hold to a digital input which activates when the heaters are turned off. When the heaters are switched on again, because the integral is at its previous value, overshoot is minimised.

Integral De-bump

This feature is not accessible to the user. When changing from Manual to Auto control, the integral component is forced to: (out put value – proportional component – derivative component) (I = OP – P – D).

This ensures that no change occurs in output at the point of switch over, ('Bumpless Transfer'). The output power then gradually changes in accordance with the demand from the PID algorithm.

If manual mode = 'Track', bumpless transfer also occurs when changing from Auto to Manual control. At the point of changeover the output power remains the same as the demand in the auto state. The value can then be altered by the operator. For other modes, the output steps to the 'Forced output' or 'Last MOP' value as appropriate. See 'Manual Mode' in Output menu items ("Output menu items" on page 148) for further details.

Loop Break

Loop Break attempts to detect loss of restoring action in the control loop by checking the control output, the process value and its rate of change. Since response times vary from process to process, the Loop Break Time (LBT) parameter (PID menu - "PID menu parameters" on page 145) allows a time to be set before a Loop Break Alarm (Loop Break - Diagnostics menu) becomes active. LBT is set automatically in Autotune.

The Loop Break Alarm parameter has no direct effect on control. In order to define behaviour under Loop Break conditions, the parameter must be wired, for example, to a relay, which can then activate an external indicator.

It is assumed that, so long as the requested output power is within the output power limits of a control loop, the loop is operating in linear control and is therefore not in a loop break condition. If, however, the output becomes saturated then the loop is operating outside its linear control region. If the output remains saturated at the same output power for a significant duration, then this might be symptomatic of a fault in the control loop. The source of the loop break is not important, but the loss of control could be catastrophic.

Since the worst case time constant for a given load is usually known, a worst case time can be calculated over which the load should have responded with a minimum movement in temperature. By performing this calculation the corresponding rate of approach towards setpoint can be used to determine if the loop can no longer control at the chosen setpoint. If the PV was drifting away from the setpoint or approaching the setpoint at a rate less than that calculated, the loop break condition would be met.

If an autotune is performed the loop break time is automatically set to $T_i \cdot 2$ for a PI or PID loop, or to $12 \cdot T_d$ for a PD loop. For an On/Off controller loop break detection is based on loop range settings as $0.1 \cdot \text{Span}$ where $\text{Span} = \text{Range High} - \text{Range Low}$. Therefore, if the output is at limit and the PV has not moved by 0.1Span in the loop break time a loop break will occur.

If the loop break time is 0 (off) the loop break time can be set manually. Then, if the output is in saturation and the PV has not moved by $>0.5 \cdot \text{PB}$ in the loop break time, a loop break condition is considered to have occurred.

Gain Scheduling

In some processes the tuned PID set may be different at low temperatures from that at high temperatures particularly in control systems where the response to the cooling power is significantly different from that of the heating power, or when changes in the process have occurred. Gain scheduling allows a number of PID sets to be stored and provides automatic transfer of control between one set of PID values and another. For this instrument, the maximum number of sets is three which means that two boundaries are provided to select when the next PID set is used. When a boundary is exceeded the next PID set is selected bumplessly. Hysteresis is used to stop scheduling oscillation at the boundaries.

Gain scheduling is basically a look up table which can be selected using different strategies or types. Auto tune tunes to the active scheduled PID set.

The following Gain Scheduled types are offered using the PID menu parameter 'Sched Type' ("PID menu parameters" on page 145):

Set	Required set selected by the user. Alternatively soft wiring may be used to control the PID set selection.
Setpoint	Transfer between sets is dependent on the setpoint value.
PV	Transfer between sets is dependent on the process value.
Error	Transfer between sets is dependent on the error value.
Output	Transfer between sets is dependent on the output demand value.
Remote	A remote parameter may be wired into the scheduler. The PID set is then selected according to the value of this input.

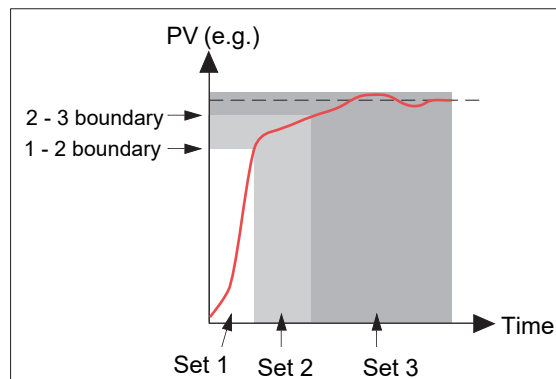

Figure 204 Gain scheduling

Tuning

Introduction

The balancing of the P, I and D terms varies from process to process. In a plastics extruder, for example, there are different responses to a die, casting roll, drive loop, thickness control loop or pressure loop. In order to achieve the best performance from an extrusion line all loop tuning parameters must be set to their optimum values.

Tuning involves setting the following PID menu parameters ("PID menu parameters" on page 145):

Proportional Band (PB), Integral Time (Ti), Derivative Time (Td), Cutback High (CBH), Cutback Low (CBL), and Relative Cool Gain (R2G - applicable to heat/cool systems only).

The recorder/controller is shipped with these parameters set to default values. In many cases the default values give adequate, stable, straight-line control, but the response of the loop may not be ideal. Because process characteristics vary it is often necessary to adjust the control parameters to achieve best control. To determine the optimum values for any particular loop or process it is necessary to carry out a procedure called loop tuning. If significant changes are later made to the process which affect the way in which it responds it may be necessary to retune the loop.

Users have the choice of tuning the loop automatically or manually. Both procedures require the loop to oscillate and both are described in the following sections.

Loop Response

Ignoring loop oscillation, there are three categories of loop performance viz Under damped, Critically damped and Over damped:

Under Damped

In this situation the parameters are set to prevent oscillation but lead to an overshoot of the Process Value (PV) followed by decaying oscillation until the PV finally settles at the Setpoint. This type of response can give a minimum time to Setpoint but overshoot may cause problems in certain situations and the loop may be sensitive to sudden changes in PV, resulting in further decaying oscillations before settling once again.

Critically Damped

This represents an ideal situation where noticeable overshoot to small step changes does not occur and the process responds to changes in a controlled, non oscillatory manner.

Over Damped

In this situation the loop responds in a controlled but sluggish manner which results in a non-ideal and unnecessarily slow loop performance.

Initial Settings

In addition to the tuning parameters listed above, there are a number of other parameters which can affect loop response. These parameters must be correctly configured before tuning is initiated. Parameters include, but are not limited to:-

Setpoint

Before tuning, the loop conditions should be set as closely as practicable to the actual conditions which will be met in normal operation. For example, in a furnace or oven application a representative load should be included, an extruder should be running, etc.

Output High, Output Low

These Output menu heat and cool limits define the overall maximum and minimum power which may be delivered to the process by the control loop. For a heat only controller the default values are 0 and 100%. For a heat/cool controller the defaults are -100 and 100%. Although most processes are designed to work between these limits there may be instances where it is desirable to limit the power delivered to the process.

Rem. Output Low, Rem. Output High

If these Remote Output Limits parameters (Output menu - "Output menu items" on page 148) are used, they are effective only if they lie within the Heat/Cool Limits above.

CH2 DeadBand

Heat/Cool Dead band. If a second (cool) channel is configured, a parameter 'Ch2 Deadband' is also available in the Output menu which sets the distance between the heat and cool proportional bands. The default value is 0% which means that heating will cease to be available at the same time as cooling becomes available. The dead band may be set to ensure that there is no possibility of the heat and cool channels operating together, particularly when cycling output stages are installed.

Minimum On Time

If either or both of the output channels is fitted with a relay or logic output, the parameter 'Min On Time' appears in the output menu. This is the cycling time for a time proportioning output and should be set correctly before tuning is started.

Filter

The 'Filter' parameter is found in the Channel 'Main' menu ("Channel Main" on page 123). It is used to remove noise from slowly changing signals so that the underlying trend can be seen more clearly.

Rate

Sets the maximum PID rate-of-change. The output rate limit is active during tuning and can affect the tuning results. Rate is useful in preventing rapid changes in output from damaging the process or heater elements. The parameter 'Rate' is found in the 'Setpoint' menu ("Setpoint menu parameters" on page 147).

CH1 Travel Time, CH2 Travel Time

Valve Travel Time. If the output is a motor valve positioner the 'Ch1 Travel Time' and 'Ch2 Travel Time' Output menu parameters must be set correctly. The valve travel time is the time taken for the valve to travel from 0% (closed) to 100% (open). This may be different from the motor travel time limits because the mechanical linkage between the motor and the valve, setting of limit switches etc. can modify behaviour. In a valve positioner application, the channel output is wired to the 'PV' input of relay 2A2B or 4AC. Configuring this relay as Type = Valve Raise causes the associated relay (3A3C or 5AC respectively) to be configured automatically as Type = Valve Lower, and the action of the relay pair is controlled by the single wire. In a heat/cool application, channel one is the heat valve and channel two is the cool valve.

Other tuning considerations

If a process includes adjacent interactive zones, each zone should be tuned independently with the adjacent zones at operating temperature.

It is recommended that a tuning process be initiated when the PV and setpoint are far apart. This allows start up conditions to be measured and cutback values to be calculated more accurately. Cutback is not set for 'Tune at setpoint'.

In a programmer/controller tuning should only be attempted during dwell periods and not during ramp stages. If a programmer/controller is tuned automatically the controller should be placed in 'Hold' during each dwell period whilst autotune is active.

Note: Tuning, carried out in dwell periods which are at different extremes of temperature may give different results owing to non linearity of heating (or cooling). This may provide a convenient way to establish values for Gain Scheduling.

If an auto tune is initiated there are two further parameters ('High Output' and 'Low Output') which need to be set. These are found in the 'Tune' menu ("Tune menu parameters" on page 145).

High Output	Sets a high output limit to be imposed during autotune. Must be \leq Output High, set in the Output menu.
Low Output	Sets a low output limit to be imposed during autotune. Must be \geq Output Low, set in the Output menu.

The above values must be set correctly, otherwise sufficient power to achieve SP might not be available during tuning, and the tune will eventually fail.

Autotune

Autotune automatically sets the following PID menu parameters ("PID menu parameters" on page 145):

PB	Proportional band.
Ti	Integral time. If previously set to 'Off' Ti will remain off after an autotune.
Td	Derivative time. If previously set to 'Off' Td will remain off after an autotune.
CBH, CBL	Cutback high and low values. If either is set to 'Auto', it will remain so after auto tuning. In order that Autotune set the cutback values for the user, a value other than 'Auto' must be selected before Autotune is initiated. Autotune never returns cutback values less than $1.6 \times PB$
R2G	Calculated only if the unit is configured as Heat/Cool. Following an Autotune, R2G lies between 0.1 and 10. If the calculated value lies outside this range, a 'Tune Fail' alarm is set.
LBT	Loop break time. Following an autotune, LBT is set to $2 \times Ti$ (if Ti was not previously set 'Off'), or to $12 \times Td$ (if Ti was previously set to 'Off').

Autotune can be performed at any time, but normally it is performed only once, during the initial commissioning of the process. However, if the process under control subsequently becomes unsatisfactory (because its characteristics have changed), it may be necessary to tune again for the new conditions.

The auto tune algorithm reacts in different ways depending on the initial conditions of the plant. The explanations given later in this section are for the following example conditions:-

1. Initial PV is below the setpoint and, therefore, approaches the setpoint from below for a heat/cool control loop
2. As above, but for a heat only control loop
3. Initial PV is at the same value as the setpoint (tune at setpoint). That is, within 0.3% of the range of the controller if 'PB Units' (Setup menu) is set to 'Percent', or +1 engineering unit (1 in 1000) if the 'PB Units' is set to 'Eng'. Range is defined as 'Range High' – 'Range Low' for process inputs or the thermocouple or RTD range defined in section A3 for temperature inputs. If the PV is just outside the range stated above the autotune will attempt a tune from above or below SP.

Autotune and Sensor Break

When the controller is autotuning and sensor break occurs, the autotune aborts and the controller outputs the sensor break output power 'Sbrk OP' set up in the Output menu ("Output menu items" on page 148). Autotune must be re-started when the sensor break condition is no longer present.

Autotune and Inhibit Or Manual

If the Loop Inhibit is asserted or the controller is put into Manual Mode, any tune in progress will be aborted and will need to be restart once the condition has been removed. Note that it is not possible to start an autotune sequence if the loop is inhibited or in Manual control.

Autotune and Gain Scheduling

When gain scheduling is enabled and an autotune is performed, the calculated PID values are written into the PID set that is active, on completion of the tune. Therefore, the user may tune within the boundaries of a set and the values will be written into the appropriate PID set. However, if the boundaries are close (because the range of the loop is not large), then, at the completion of the tune, it cannot be guaranteed that the PID values will be written to the correct set particularly if the schedule type is PV or OP. In this situation the scheduler ('Sched Type') should be switched to 'Set' and the 'active set' chosen manually.

Initial Conditions

Configure the parameters described in "Initial Settings" on page 409 and "Other tuning considerations" on page 410.

Notes:

1. The 'tighter' power limit applies. For example, if 'High Output' is set to 80% and 'Output High' is set to 70% then the output power will be limited to 70%.
2. The PV must oscillate to some degree to allow the tuner to calculate the relevant values. The limits must be set so as to allow oscillation about the setpoint.

Initiating the Autotune

In the Loop Tune menu ("Tune menu parameters" on page 145) for the relevant loop, set 'Tune Enable' to 'On'.

Example 1: Autotune From Below Sp (Heat/Cool)

The point at which Automatic tuning is performed (Tune Control Point) lies just below the setpoint at which the process is normally expected to operate (Target Setpoint). This ensures that the process is not significantly overheated or overcooled. The Tune Control Point is calculated as follows:

$$\text{Tune Control Point} = \text{Initial PV} + 0.75(\text{Target Setpoint} - \text{Initial PV}).$$

The Initial PV is the PV measured after a 1 minute settling period (point 'B' in the figure below).

Examples:

If Target Setpoint = 500°C and Initial PV = 20°C, then the Tune Control Point is 380°C.

If Target Setpoint = 500°C and Initial PV = 400°C, then the Tune Control Point is 475°C.

This is because the overshoot is likely to be less as the process temperature approaches the target setpoint.

[Figure 205](#) shows the auto tune sequence.

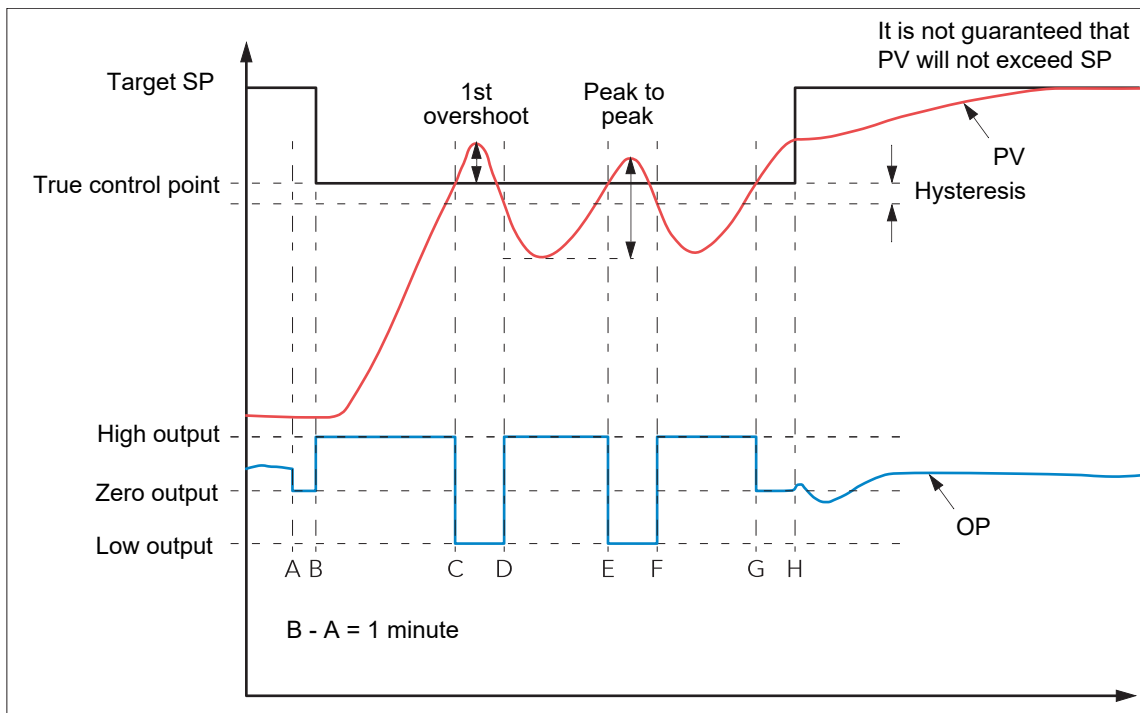

Figure 205 Autotune heat/cool process

Key

- | | |
|--------|--|
| A | Start of Autotune |
| A to B | Heating and Cooling off for one minute allows steady state conditions to be established. |
| B to D | First heat/cool cycle to establish first overshoot. Cutback low (CBL) value calculated from the overshoot magnitude (unless CBL set to 'Auto'). |
| B to F | Two cycles of oscillation allow peak-to-peak value and oscillation period to be determined. PID terms are calculated. |
| F | Heating is switched on. |
| G | Heating (and cooling) are switched off allowing the plant to respond naturally. Measurements over the period F to G are used to calculate the Relative Cool Gain (R2G). Cutback High is calculated from the equation ($CBH = CBL \times R2G$). |
| H | Autotune is turned off and the process is allowed to control at the target setpoint using the new control terms. |

Note: Recommended external fuse ratings are: 2A Type T 250V.

Example 2: Autotune From Below Sp (Heat Only)

The sequence of operation for a heat only loop is the same as that described above for a heat/cool loop, except that the sequence ends at 'F' since there is no need to calculate 'R2G' (R2G is set to 1.0 for heat only processes). At 'F' autotune is turned off and the process is allowed to control using the new control terms.

For a tune from below setpoint 'CBL' is calculated on the basis of the size of the overshoot (assuming it was not set to Auto in the initial conditions). CBH is then set to the same value as CBL.

Note: Autotune can also occur when the initial PV is above SP. The sequence is the same as tuning from below setpoint except that the sequence starts with natural cooling applied at 'B' after the first one minute settling time. In this case CBH is calculated and CBL is then set to the same value as CBH.

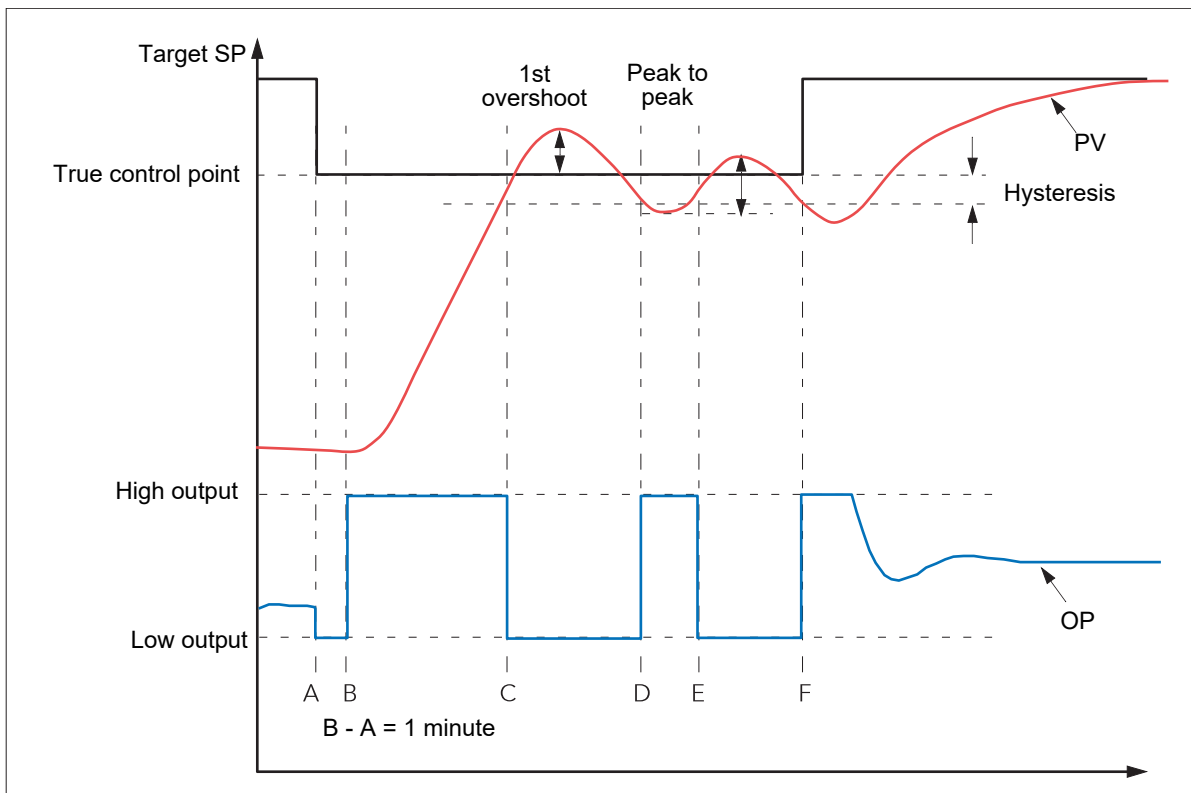

Figure 206 Autotune heat only process (from below SP)

A	Start of Autotune
A to B	Heating off for one minute to allow steady state conditions to be established.
B to D	First heat cycle to establish first overshoot. Cutback low (CBL) value calculated from the overshoot magnitude (unless CBL set to 'Auto').
D to F	Calculate PID terms.
F	Autotune is turned off and the process is allowed to control at the target setpoint using the new control terms.

Example 3: Autotune At Sp (Heat /Cool)

It is sometimes necessary to tune at the actual setpoint being used as shown below.

For a tune at setpoint, autotune does not calculate cutback since there was no initial start up response to the application of heating or cooling. Cutback values of less than 1.6 ' PB will not be returned.

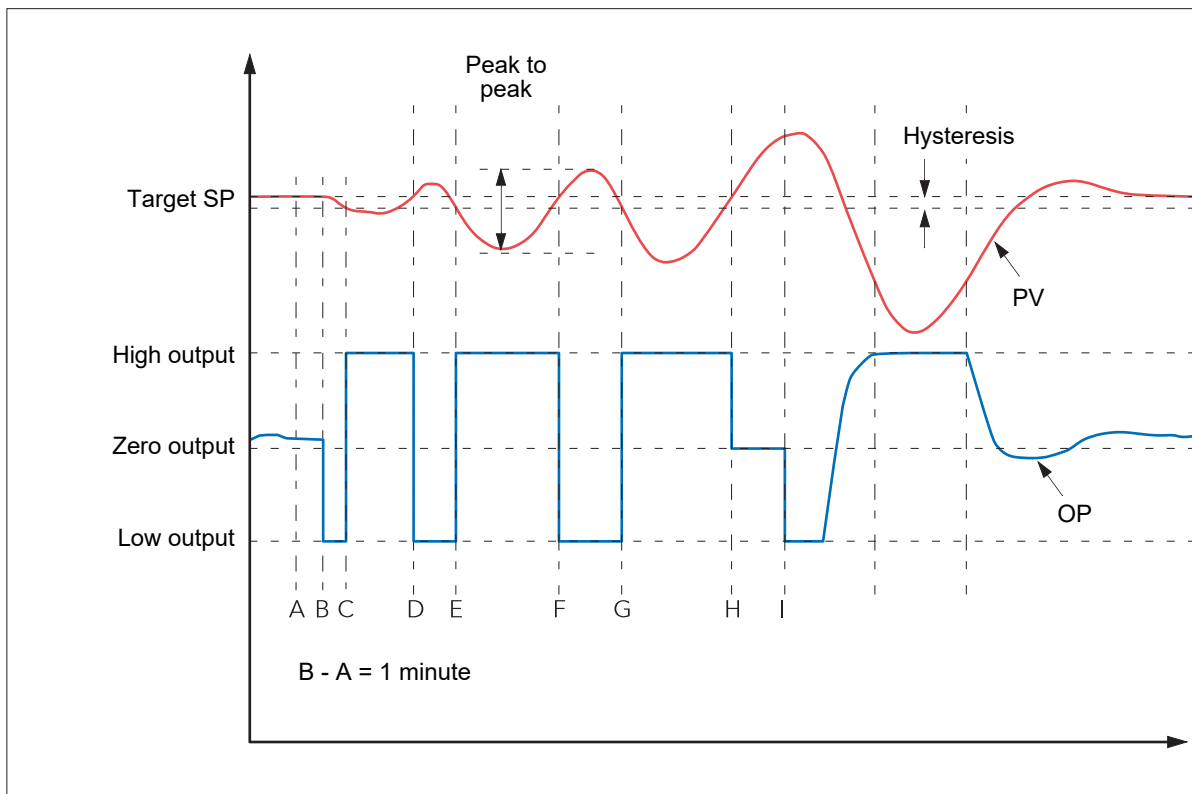

Figure 207 Autotune at setpoint

- A** Start of Autotune. A test is done at the start of autotune to establish conditions for a tune at setpoint. Conditions are that SP must remain within 0.3% of the range of the controller if 'PB Units' (Setup menu - "Setup menu parameters" on page 144) is set to 'Percent', or +1 engineering unit (1 in 1000) if the 'PB Units' is set to 'Eng'. Range is defined as 'Range High' – 'Range Low' for process inputs or the thermocouple or RTD range defined in A3 for temperature inputs.
- A to B** The output is frozen at the current value for one minute, and the conditions are continuously monitored during this period. If the conditions specified above are met, then an autotune at setpoint is initiated at 'B'. If PV drifts outside the condition limits at any time during this period, tuning at SP is abandoned, and tuning resumes as a 'tune from above' or 'tune from below', depending on the direction of drift. Since the loop is already at setpoint, a Tune Control setpoint is not calculated; the loop is forced to oscillate about the Target SP.
- C to G** The process is forced to oscillate by switching the output between the output limits. The oscillation period and the peak-to-peak response are determined, and the PID terms calculated.
- G to H** An extra heating stage is initiated, then all heating and cooling are switched off at H, allowing the plant to respond naturally. The relative cool gain (R2G) is calculated.
- I** Autotune is switched off and the process is allowed to con-

AT.R2G

Some load types and process conditions can cause autotune to set an incorrect value for R2G resulting in an instability in the system after an autotune has completed. In such circumstances, the value of R2G should be checked, and if it is low (approaching 0.1) a manual entry should be made as follows:

1. In the Tune menu, set the AT.R2G parameter to 'No'.
2. In the PID menu, enter the new R2G value (calculated as described below)
3. In the Tune menu, enter a value for Low Output, calculated from: Low Output = -High Output x R2G
4. In the Tune menu, set 'TuneEn' On.

R2G Calculation

1. In the Main menu, set the controller to Manual mode
2. Turn heating on (limited by the value of 'Output High' in the Output menu - "Output menu items" on page 148) and measure the heating rate ('H' °C/minute).
3. Allow the process to heat to, say, 10% above the setpoint value then turn the heating off and allow the temperature to settle.
4. Turn cooling power on (limited by the value of 'Output Low' in the Output menu) and measure the cooling rate ('C' °C/minute) whilst allowing the temperature to fall below the setpoint value.
5. Calculate the value of R2G from the equation $R2G = (H/C) \times (\text{Output Low/output High})$

Example:

For a measured heating rate (H) of 10°C per min and a measured cooling rate (C) of 25° per minute and with, Output High = 80% and Output Low = 40%, then $R2G = (10/25) \times (40/80) = 0.4 \times 0.5 = 0.2$.

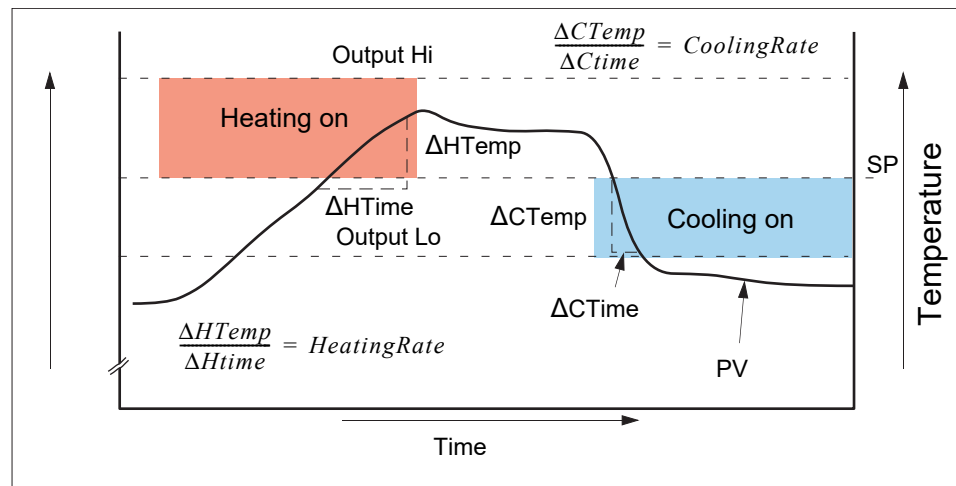

Figure 208 R2G calculation

Note: This is not a very accurate method as it does not take natural cooling into account. Its main advantage is that it is simple to achieve.

Failure Modes

The conditions for performing an autotune are monitored by the Tune menu ("Tune menu parameters" on page 145) parameter 'State'. If autotune is not successful error conditions are read by this parameter as follows:

Timeout	Set if any one stage is not completed within an hour. Possible causes are the loop being open circuit, or not responding to the controller demands. Some heavily lagged systems may produce a timeout if the cooling rate is very slow.
TI Limit	This is set if Autotune calculates a value for the integral term which is greater than the maximum allowable (99999 seconds). This indicates that the loop is not responding or that the tune is taking too long.
R2G Limit	Error occurs if the calculate value of R2G is outside the range 0.1 to 10.0. R2G limit can occur if the gain difference between heating and cooling is too large, or if the controller is configured for heat/cool, but the heating and/or cooling device is turned off or not working correctly.

Relative Cool Gain in Well Lagged Processes

In the majority of processes Relative Cool Gain R2G is calculated by the autotune algorithm as described in the previous sections.

There are occasions, however, where an alternative algorithm may be preferred. These are processes which are heavily lagged, where the heat loss to ambient is very small so that natural cooling is extremely slow, and certain high order plants, those that need derivative, Td. This algorithm is known as R2GPD and has been added to controllers from firmware version V4.10.

The type of algorithm is selected using the parameter 'Tune R2G' found in the Auto-Tune list, "Tune menu parameters" on page 145. The choices are:-

Standard	This is the default as described in example 2 in "Autotune" on page 411. and is suitable for use on most processes. The benefit of this algorithm is that it is relatively quick. However, in the type of process described in the previous paragraph, it can produce values which are not ideal. These values are generally identified by R2G equal to or very close to 0.1.
R2GPD	If the process is known to be heavily lagged or produces values such as those above then R2GPD should be selected. This algorithm extends the autotune period by putting the controller into proportional plus derivative mode (PD) and uses the output power demand value during this period to determine the Relative Cool Gain.
Off	The automatic calculation of Relative Cool Gain can be turned off and the value entered manually as described in "Relative cool gain (R2G)" on page 404.

Example 4: When Tune R2G = R2GPD, Autotune from below setpoint

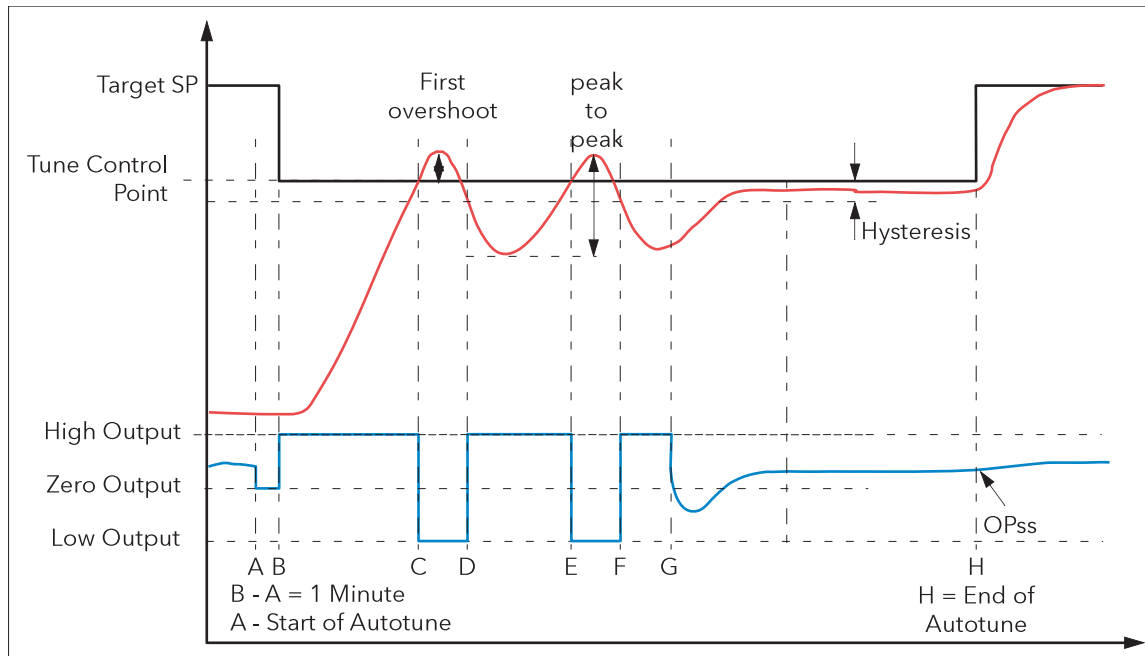

Figure 209 Autotune from below setpoint

Periods A-F are largely unchanged from the 'Standard' algorithm, Example 2 in "Autotune" on page 411 with the following exception:

- Changing the Target Setpoint during period A-B will not change the tuning setpoint.

Period F-H is replaced as follows:

F to G	Heat is applied for a period (F-G) of half the first heat cycle (D-E) to compensate for the last cool cycle.
G to H	This is a period in which the controller is put into PD control. The values of proportional term and derivative time for this period of PD control are determined by the algorithm.
H	OPss is the output demand value at the end of this period and is used in the determination of R2G.

Manual tuning

If, for any reason, automatic tuning gives unsatisfactory results the controller can be tuned manually. There are a number of standard methods for manual tuning, the Zeigler-Nichols method being described here:

1. Adjust the setpoint to its normal running conditions (assumed to be above the PV so that 'heat only' is applied).
2. Set the integral and derivative times (Ti and Td) to 'Off'
3. Set High and Low cutback (CBH and CBL) to 'Auto'.
4. If the PV is stable (not necessarily at the setpoint), reduce the proportional band (PB) such that the PV just starts to oscillate, leaving time between adjustments to allow the loop to stabilise. Make a note of the PB at this point (PB'), and also note the oscillation period ('T').
If the PV is already oscillating measure the oscillation period ('T') and then gradually increase PB to the point at which oscillation just ceases. Make a note of the PB (PB') at this point.
5. If the controller is fitted with a cooling channel, enable this now.
6. Observe the oscillation waveform and adjust 'R2G' until a symmetrical wave form is observed (Figure "Manual tuning" on page 419).
7. Set PB, Ti and Td according to the table shown in [Figure 210](#).

Control type	PB	Ti	Td
Proportional only	$2 \times PB'$	Off	Off
P + I	$2.2 \times PB'$	$0.8 \times T$	Off
P + I + D	$1.7 \times PB'$	$0.5 \times T$	$0.12 \times T$

Figure 210 Calculate parameter values

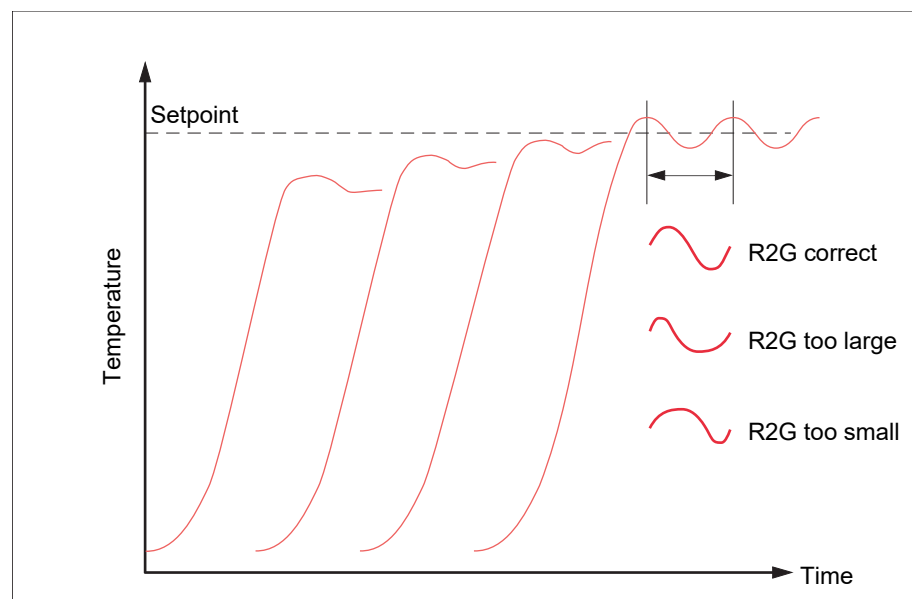

Figure 211 Relative Cool Gain

Cutback Values

The PID terms calculated from the table shown in [Figure 210](#), should be entered before the cutback values are set.

The above procedure sets up the parameters for optimum steady state control. If unacceptable levels of overshoot or undershoot occur during start-up, or for large step changes in PV, then the cutback parameters should be set manually, as follows:

1. Initially set the cutback values to one proportional bandwidth converted into display units. This can be calculated by taking the value in percent that has been installed into the parameter 'PB' and entering it into the following formula:

$$\text{PB}/100 \cdot \text{Span of controller} = \text{Cutback High and Cutback Low}$$
 For example, if PB = 10% and the span of the controller is 0 to 1200°C, then
 Cutback High = Cutback Low = $10/100 \cdot 1200 = 120$
2. If overshoot is observed following the correct settings of the PID terms increase the value of 'CBL' by the value of the overshoot in display units. If undershoot is observed increase the value of the parameter 'CBH' by the value of the undershoot in display units.

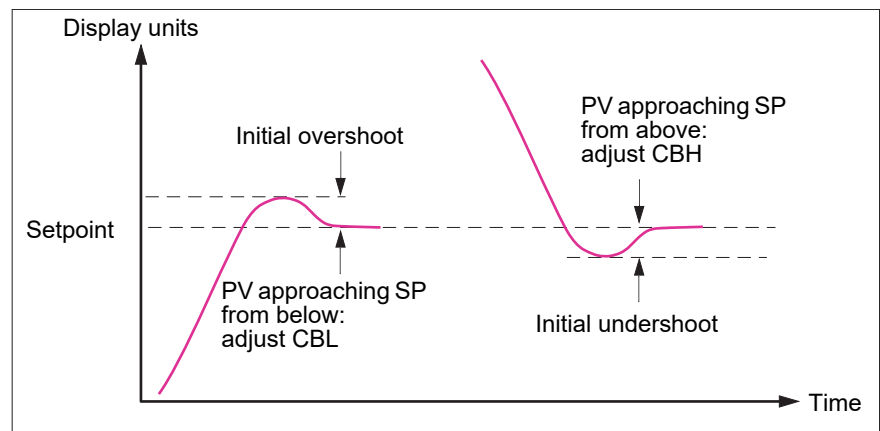

Figure 212 Manual Cutback setting

Setpoint

The controller setpoint is the Working Setpoint which can be derived from:

1. SP1 or SP2, both of which are manually set by the user and can be switched into use by an external signal or via the user interface.
2. From an external (remote) analogue source
3. The output of a programmer function block.

Setpoint function block

As well as providing a setpoint, the function block also provides:

1. The ability to limit the rate of change of the setpoint before it is applied to the control algorithm.
2. Upper and lower limits. These are defined as setpoint limits, 'SP High Limit' and 'SP Low Limit', for the local setpoints and instrument range high and low for other setpoint sources.

Note: All setpoints are limited by 'Range High' and 'Range Low' so that if 'SP High Limit', for example, is set higher than 'Range High', then 'SP High Limit' is ignored and the setpoint is limited at the 'Range High' value.

User configurable methods for tracking are available, such that the transfers between setpoints and between operating modes do not cause 'bumps' in the setpoint.

Figure 213 shows the function block schematic.

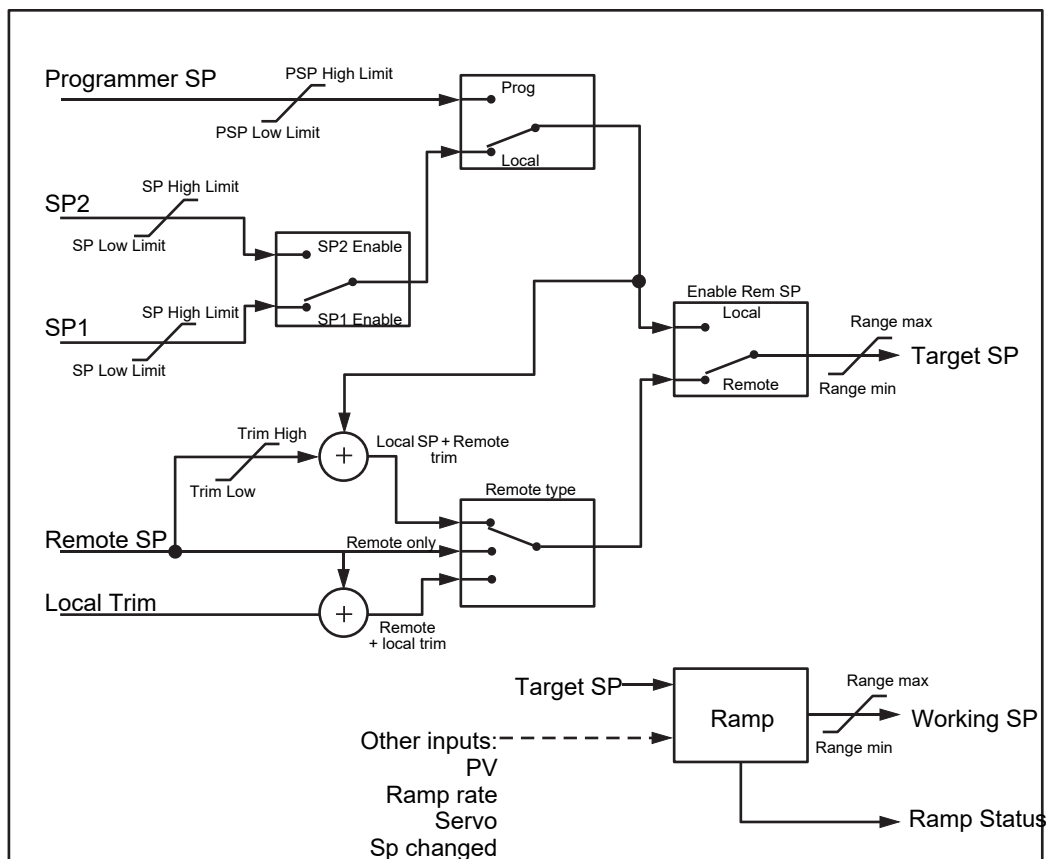

Figure 213 Setpoint Function block

Setpoint Limits

The setpoint generator provides limits for each of the setpoint sources as well as an overall set of limits for the loop. These are summarised in [Figure 214](#).

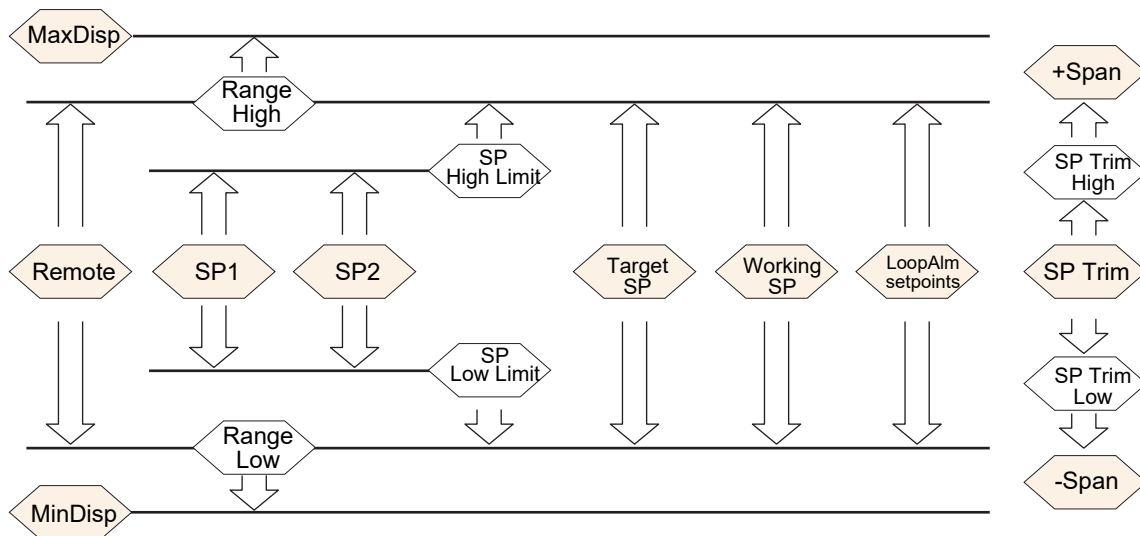

Figure 214 Setpoint Limits

'Range High' and 'Range Low' provide the range information for the control loop. They are used in control calculations to generate proportional bands. $\text{Span} = \text{Range High} - \text{Range Low}$.

Setpoint Rate Limit

This symmetrical rate limiter allows the rate of change of setpoint to be controlled, preventing step changes in the setpoint. The limit is applied to the working setpoint which includes setpoint trim.

Rate limiting is enabled using the 'Rate' parameter. If this is set to '0' then any change made to the setpoint will be effective immediately. If it is set to any other value, then a change in the setpoint will have rate limiting applied at the value set, in units per minute. Rate limit applies to SP1, SP2 and Remote SP.

When rate limit is active 'Rate Done' displays 'No'. When the setpoint has been reached the value changes to 'Yes'.

When 'Rate' is set to a value (other than 'Off') an additional parameter 'SP Rate Disable' is displayed which allows the setpoint rate limit to be turned off and on without the need to adjust the 'Rate' parameter between Off and a working value.

If the PV is in sensor break, the rate limit is suspended and the working setpoint takes the value of 0. On sensor break being released the working setpoint goes from 0 to the selected setpoint value at the rate limit.

Setpoint Tracking

The setpoint used by the controller may be derived from a number of sources. For example:-

1. Local setpoints SP1 and SP2. These may be selected through the front panel using the parameter 'SP Select', through digital communications or by configuring a digital input which selects either SP1 or SP2. This might be used, for example, to switch between normal running conditions and standby conditions. If Rate Limit is switched off the new setpoint value is adopted immediately when the switch is changed.
2. A programmer generating a setpoint which varies over time. When the programmer is running, the 'Track SP' and 'Track PV' parameters update continuously so that the programmer can perform its own servo. This is sometimes referred to as 'Program Tracking'.
3. From a Remote analogue source. The source could be an external analogue input into an analogue input module wired to the 'Alt SP' parameter or a User Value wired to the 'Alt SP' parameter. The remote setpoint is used when the parameter 'Alt SP Enable' is set to 'Yes'.

Setpoint tracking (sometimes referred to as Remote Tracking) ensures that the Local setpoint adopts the Remote setpoint value when switching from Local to Remote to maintain bumpless transfer from Remote to Local. Bumpless transfer does not take place when changing from Local to Remote.

Note: If Rate Limit is applied, the setpoint will change at the set rate, when changing from Local to Remote.

Manual Tracking

When the controller is operating in manual mode the currently selected SP (SP1 or SP2) tracks the PV. When the controller resumes automatic control there will be no step change in the resolved SP. Manual tracking does not apply to the remote setpoint or programmer setpoint.

Output

Introduction

The output function block selects the correct output sources to be used, determines whether to heat or cool and then applies limits. Power feed forward and non-linear cooling are also applied.

It is this block that manages the output in exception conditions such as start up and sensor break.

The outputs, 'Ch1 Output' and 'Ch2 Output', are normally wired to a digital I/O where they are converted into analogue or time proportioned signals for electrical heating, cooling or valve movement.

Output Limits

Figure 215 shows where output limits are applied.

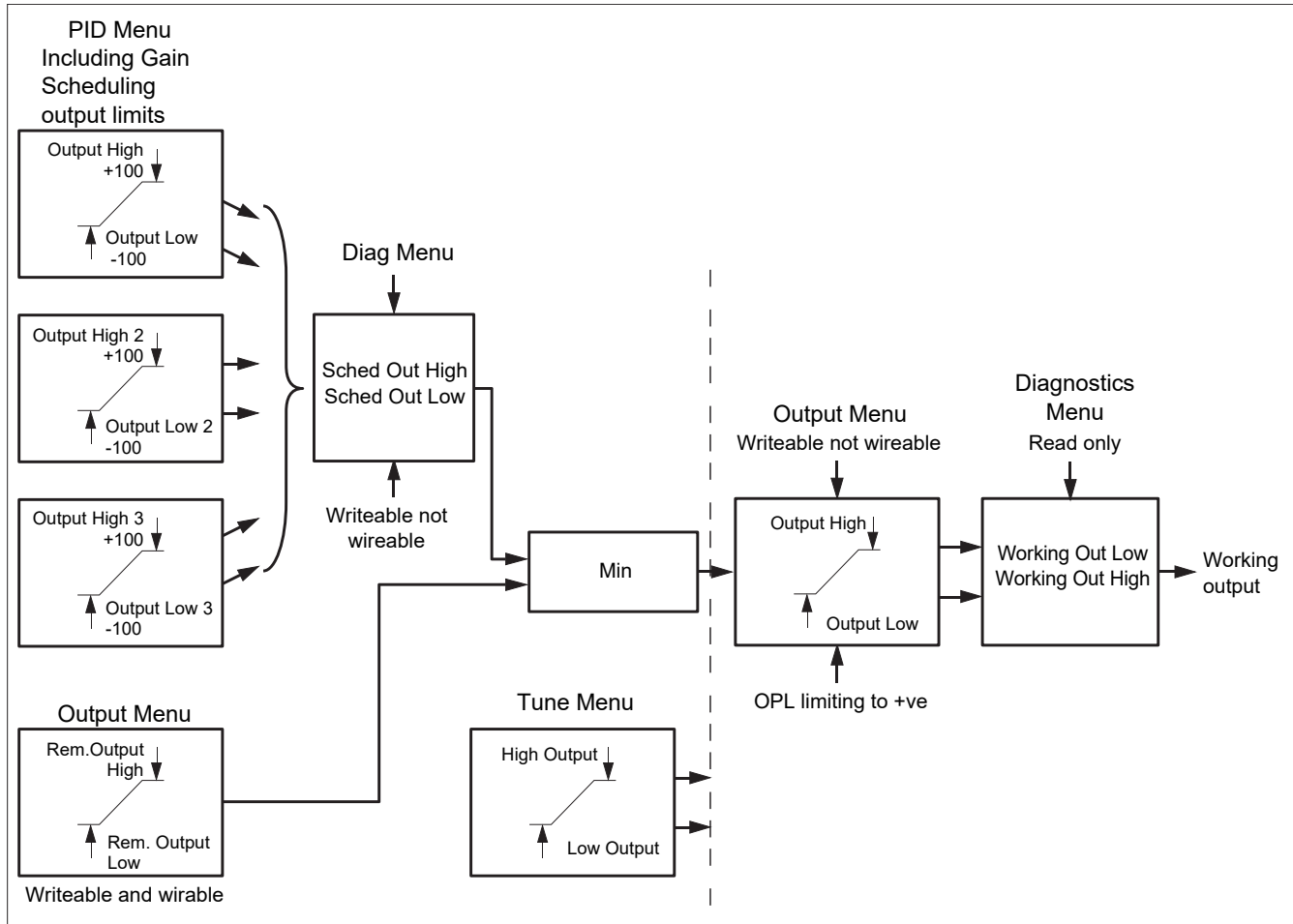

Figure 215 Output Limits

Notes:

1. Individual output limits may be set in the PID list for each set of PID parameters when gain scheduling is in use.
2. Limits may also be applied from an external source. These are 'Rem. Output High' and 'Rem. Output Low' found in the Output menu. These parameters are wireable; for example they may be wired to an analogue input module so that a limit may be applied through some external strategy. If these parameters are not wired +100% limit is applied every time the instrument is powered up.
3. The tightest limits (between Remote and PID) are connected to the output where an overall limit is applied using parameters 'Output High' and 'Output Low'.
4. 'Working Out High' and 'Working Out low' found in the Diagnostics list are read only parameters showing the overall working output limits.
5. The tune limits are a separate part of the algorithm and are applied to the output during the tuning process. The overall limits 'Output Hi' and 'Output Lo' always have priority.

Output Rate Limit

The output rate limiter is a rate-of-change limiter, set in (%/sec) which prevents step changes in output power being demanded. Rate limiting is performed by determining the direction in which the output is changing, and then incrementing or decrementing the Working Output (Main menu - "Main menu parameters" on page 143) until it equals the required output (Target OP).

The amount to increment or decrement is calculated using the sampling rate of the algorithm (125ms) and the selected rate limit. If the change in output is less than the rate limit increment the change takes effect immediately.

The rate limit direction and increment is calculated on every execution of the rate limit. Therefore, if the rate limit is changed during execution, the new rate of change takes immediate effect. If the output is changed whilst rate limiting is taking place, the new value takes immediate effect on the direction of the rate limit and in determining whether the rate limit has completed.

The rate limiter is self-correcting such that if the increment is small it is accumulated until it takes effect.

The output rate limit is active when the loop is in both auto and manual modes, and during autotune.

Sensor Break Mode

If a Sensor break is detected by the measurement system the loop reacts in one of two ways, according to the configuration of 'Sbrk Mode' ('Safe' or 'Hold'). On exit from sensor break the transfer is bumpless – the power output starts controlling again from the current operating setpoint and moves, under PID closed-loop control, from its pre-set value to the control value.

Safe

If set to 'Safe', the output adopts a pre-set level (Sbrk OP). If rate limit is not configured, the output steps to the Sbrk OP value, otherwise it ramps to this value at the rate limit.

Hold

If set to 'Hold' the output remains at its current value. If Output Rate Limit (Rate) has been configured a small step may be seen as the working output will limit to the value existing two iterations ago.

Forced Output

This feature enables the user to specify what the output of the loop should do when moving from automatic control to manual control. The default is that the output power is maintained but it is then adjustable by the user.

If Manual Mode is set to 'Step', the user can set a manual output power value and on transition to manual the output will be forced to that value.

If Manual Mode is set to 'Track' the output steps to the forced manual output and then subsequent edits to the output power are tracked back into the manual output value.

If Manual Mode is set to 'Last Man. Out' then when moving from automatic to manual mode, the output adopts the last manual output value.

Power Feed Forward

Power feed forward is used when driving an electrical heating element. It monitors the line voltage and compensates for fluctuations before they affect the process temperature. The use of this will give better steady state performance when the line voltage is not stable.

It is mainly used for digital type outputs which drive contactors or solid state relays. Because it only has value in this type of application it can be switched off using the parameter 'Pff En'. It should also be disabled for any non-electric heating process. It is not necessary when Eurotherm analogue thyristor control is used since compensation for power changes is included in the thyristor driver.

Consider a process running at 25% power, with zero error and then the line voltage falls by 20%. The heater power would drop by 36% because of the square law dependence of power on voltage. A drop in temperature would result. After a time, the thermocouple and controller would sense this fall and increase the ON-TIME of the contactor just enough to bring the temperature back to set point. Meanwhile the process would be running a bit cooler than optimum which may cause some imperfection in the product.

With power feed forward enabled the line voltage is monitored continuously and ON-TIME increased or decreased to compensate immediately. In this way the process need never suffer a temperature disturbance caused by a line voltage change.

'Power Feed forward' should not be confused with 'Feed forward' which is described in "Feed forward" on page 427.

Cool Type

Cooling methods vary from application to application. For example, an extruder barrel may be cooled by forced air (from a fan), or by circulating water or oil around a jacket. The cooling effect will be different depending on the method. 'Cool Type' (appears only if the 'setup' parameter 'Ch2 Control' is set to 'PID') is used to accommodate different types of cooling methods as follows:

Linear

The cooling algorithm may be set to linear where the controller output changes linearly with the PID demand signal.

Oil Cooling

'Cool Type' = 'Oil'. As oil is, to all intents and purposes, non-evaporative, oil cooling is pulsed in a linear manner.

Water Cooling

If the area being cooled is running well above 100°C, then the first few pulses of water flash into steam giving greatly increased cooling due to the latent heat of evaporation. When the area cools, less (or even no) evaporation takes place and the cooling is less effective.

Setting 'Cool Type' to 'Water' delivers much shortened pulses of water for the first few percent of the cooling range, when the water is likely to be flashing into steam. This compensates for the transition out of the initial strong evaporative cooling.

Fan Cooling

'Cool Type = 'Fan'. Fan cooling is much gentler than water cooling and not so immediate or decisive (because of the long heat transfer path through the process mechanics). With fan cooling, a cool gain setting of '3' upwards is typical. Delivery of pulses to the blower is non linear, this non-linearity being caused by a combination of forced air movement and fan efficiency as a function of air velocity (e. g. the efficiency of a fan when producing a low speed (laminar) air flow is different from its efficiency when producing a high-speed, turbulent flow.

Feed forward

Feed forward is a method of adding an extra scalable component to the PID output, before any limiting. It can be used, for example, in the implementation of cascade loops and constant head control or it can be used to pre-load the control signal with a value close to that which is required to achieve the setpoint, thus improving system response. Feed forward (FF) is applied such that the PID output is limited by trim limits and acts as a trim on a FF value. The FF value is derived either from the PV or setpoint by scaling the PV or SP by the 'FF Gain' and 'FF Offset'. Alternatively, a remote value may be used for the FF value, but this is not subject to any scaling. The resultant FF value is added to the limited PID OP and becomes the PID output as far as the output algorithm is concerned. The feedback value then generated must then have the FF contribution removed before being used again by the PID algorithm. The diagram below shows how feed forward is implemented.

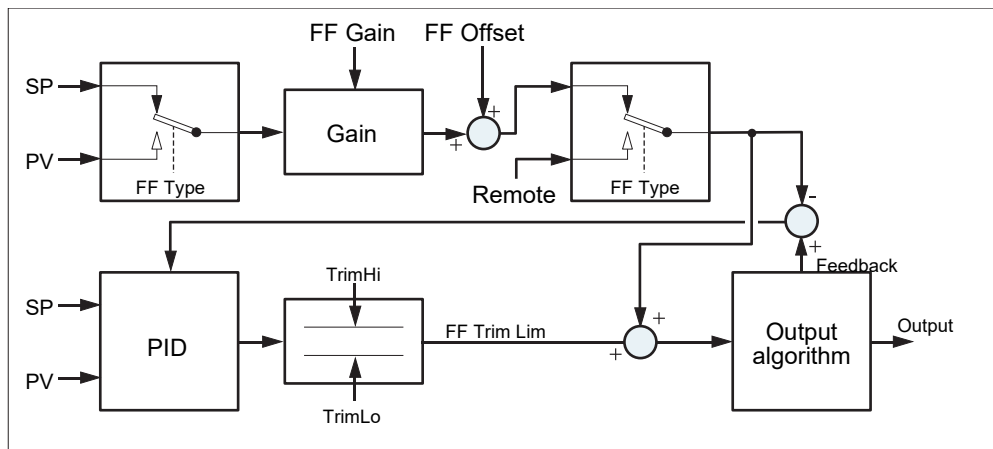

Figure 216 Implementation of Feed forward

Effect of Control Action, Hysteresis and Deadband

Control Action

For temperature control 'Control Act' should be set to 'Rev'. For a PID controller this means that the heater power decreases as the PV increases. For an on/off controller, output 1 (usually heat) will be on (100%) when PV is below the setpoint and output 2 (usually cool) will be on when PV is above the setpoint.

Hysteresis

Hysteresis applies to on/off control only and is set in the units of the PV. In heating applications the output will turn off when the PV is at setpoint. It will turn on again when the PV falls below SP by the hysteresis value. This shown in [Figure 217](#) and [Figure 218](#) for a heat and cool controller.

Hysteresis is intended to prevent the output from repeated switching on and off 'chattering' at the control setpoint. If the hysteresis is set to 0 then even the smallest change in the PV when at setpoint will cause the output to switch. Hysteresis should be set to a value which provides an acceptable life for the output contacts, but which does not cause unacceptable oscillations in the PV.

If this performance is unacceptable, it is recommended that PID control be used instead.

Deadband

Deadband 'Ch2 Deadband' can operate on both on/off control or PID control where it has the effect of extending the period when no heating or cooling is applied. In PID control the effect is modified by both the integral and derivative terms. Deadband might be used in PID control, for example, where actuators take time to complete their cycle thus ensuring that heating and cooling are not being applied at the same time. Deadband is likely to be used, therefore, in on/off control only. [Figure 218](#) adds a deadband of 20 to the first example in [Figure 217](#).

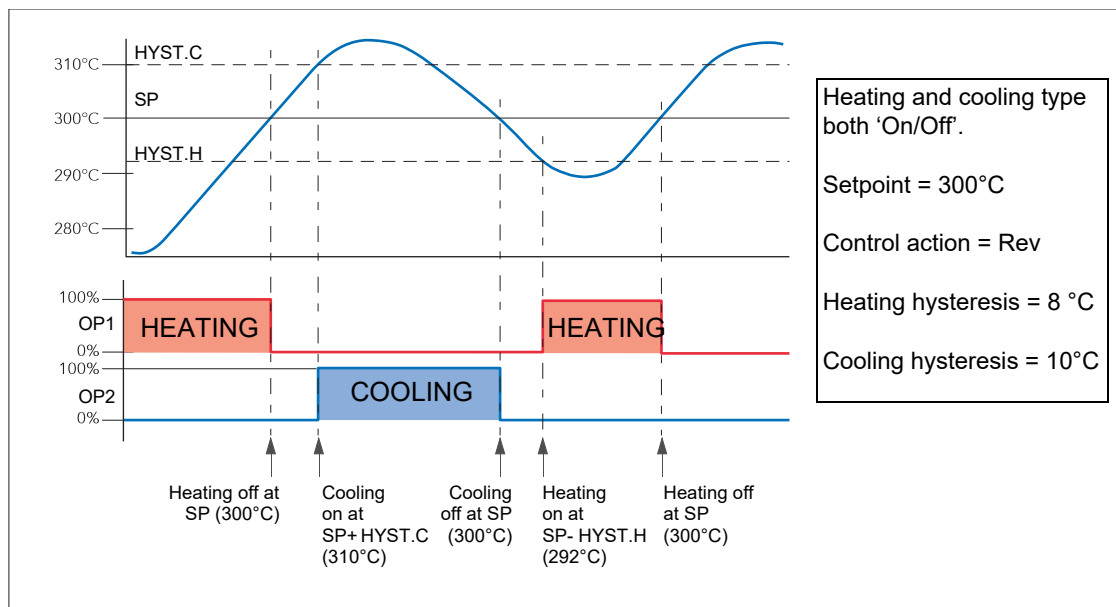

Figure 217 Deadband OFF

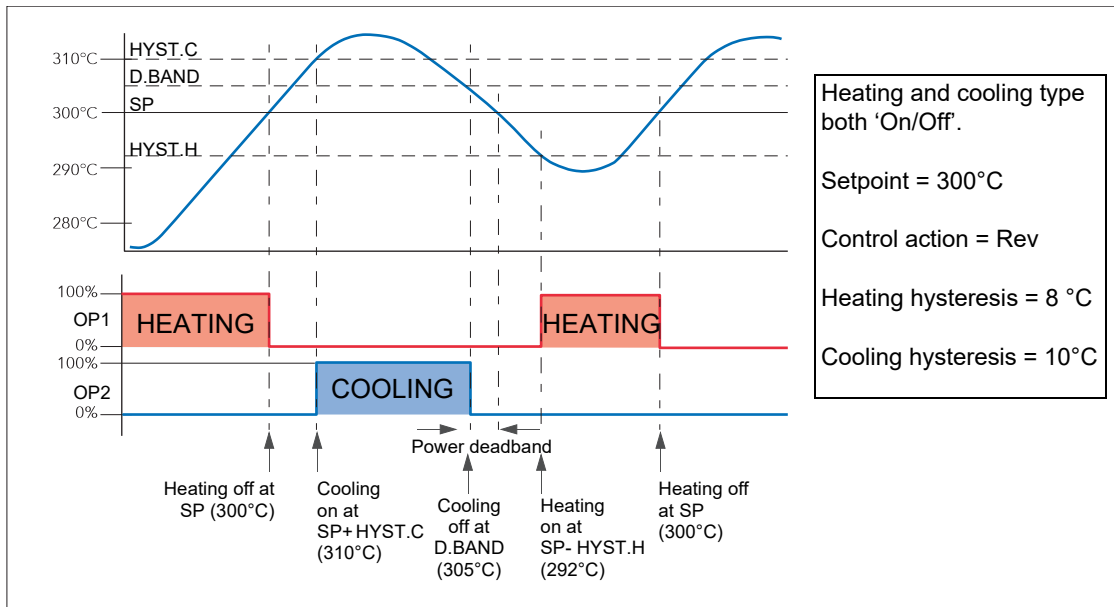

Figure 218 Deadband ON set at 50% of Cooling.

Valve nudge

For systems configured as Unbounded Valve Positioning (VPU) - set up in Loop Setup configuration (Ch1(2) control - "Setup menu parameters" on page 144), it is possible to move the valve in small increments towards the open position (Nudge Raise - "Output menu items" on page 148) or towards the closed position (Nudge Lower - "Output menu items" on page 148). The trigger for such nudging can be a digital input (e.g. contact closure) 'wired' to the nudge raise or lower parameter, the up or down arrow keys or a command received over the serial link.

The nudge command causes the valve drive output to drive the valve for either the minimum on time, or for as long as the command is 'true', whichever is the longer (note 2). The default minimum on time is 125ms, but this can be edited in the configuration for the relevant output relay ("Implicit inputs/outputs" on page 191).

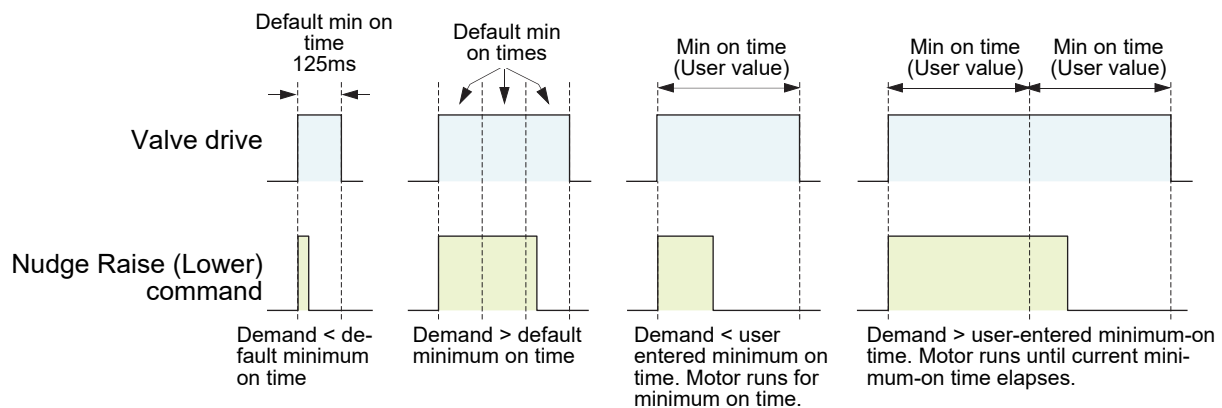

Figure 219 Valve nudge examples

Notes:

1. If Ch1 is set to VPU, Nudge operates the channel 1 valve, no matter what Ch2 is set to. If Ch1 is not set to VPU, and Ch2 is set to VPU then the nudge operates on channel 2 valve.

- The minimum on time is continuously re-triggered. This means that if a minimum on time of (say) 10 seconds has been configured, then the valve may continue to move for up to 10 seconds after the command has been removed. That is, it continues until the current minimum on time period has expired.

Time Proportioning

PID controllers sometimes use Time Proportioning to control the average power to the load. This is done by repeatedly switching the output on for a period (T_{on}) and then off for a period (T_{off}). The total period ($T_{on} + T_{off}$) is called the 'cycle time'. During each cycle, the average power delivered to the load is:

$$P_{Avg} = P_{Heater} \times \text{Duty cycle},$$

where ' P_{Heater} ' is the actual transferred heater (or cooler) power and Duty cycle = $T_{on}/(T_{on} + T_{off})$, normally represented as a percentage value.

The PID controller calculates the Duty Cycle (the PID output control signal from 0 to 100%) and provides a Minimum on time between 100ms to 150 seconds.

Figure B2.6.11 shows how T_{on} , T_{off} and cycle time vary with demand percentage.

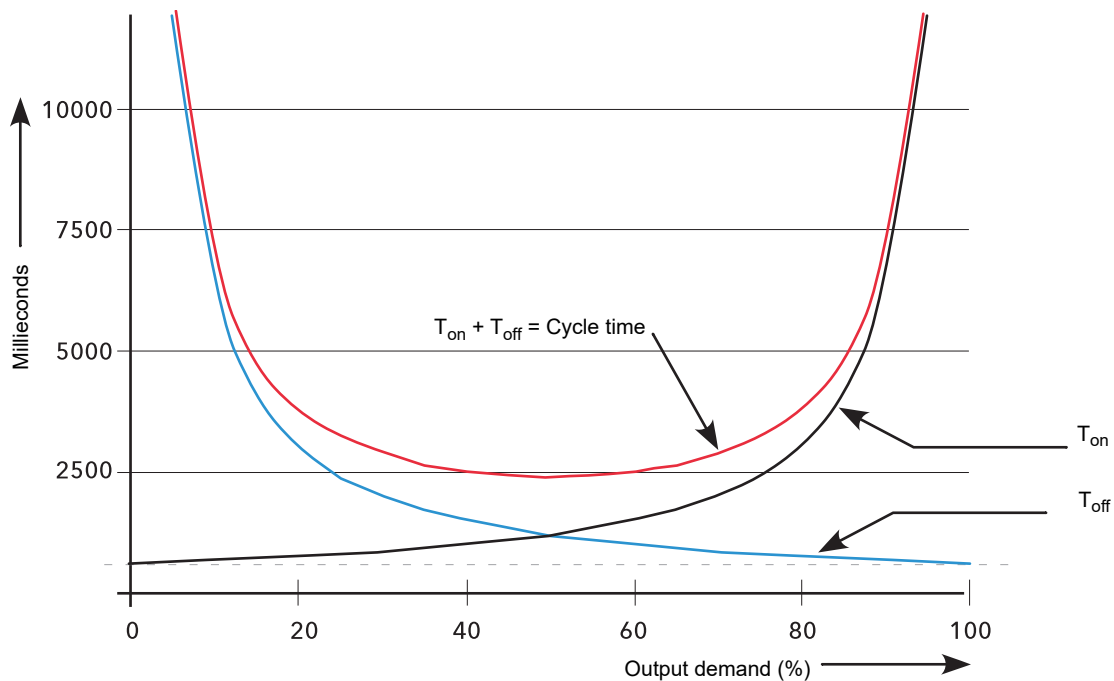

Figure 220 Time proportioning curves (Minimum on time = 625ms)

Note: For this instrument, only 'Min on time' is configurable

Diagnostics

See "Loop diagnostics" on page 150 for definitions of these parameters.

Appendix C: Reference

Battery

This instrument is fitted with a battery which has a minimum life of 1 year unpowered and when stored in an ambient temperature of around 25°C. The battery life may be reduced if it is consistently operated in an elevated ambient temperature environment. The battery is designed to retain configuration and other settings in the event of a failure of the instrument power supply.

The battery is not user serviceable and any instrument displaying the symptoms of a battery fail should be returned to your supplier for battery replacement at the earliest opportunity.

NOTICE

LOSS OF DATA

With the instrument working normally, a clone file* should be made and stored, to save the instruments configuration.

A clone file* is made and stored in a known safe location so that the settings can be uploaded to a spare instrument or restored to the instrument following replacement of the battery. (Alternatively maintain a record of the instrument configuration and other important settings).

* A clone file is made using iTools, a proprietary package which may be downloaded from: www.eurotherm.com.

Setting Up An FTP Server Using Filezilla

Downloading

'FileZilla' is a free download from the internet (search for 'FileZilla server download').

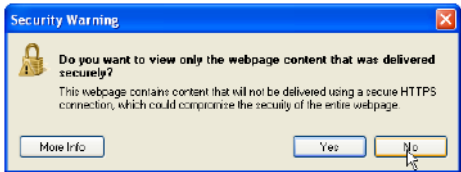
1. Download the latest version, following the instructions on the screen.
2. Answer 'No' to the question 'Do you want to view only the webpage content that was delivered securely?'. 
3. If necessary enable file download.
4. In the 'Do you want to run or save this file' Security Warning window, click on 'Run'.
5. In the 'The Publisher could not be verified...', Security Warning window, click on 'Run'.

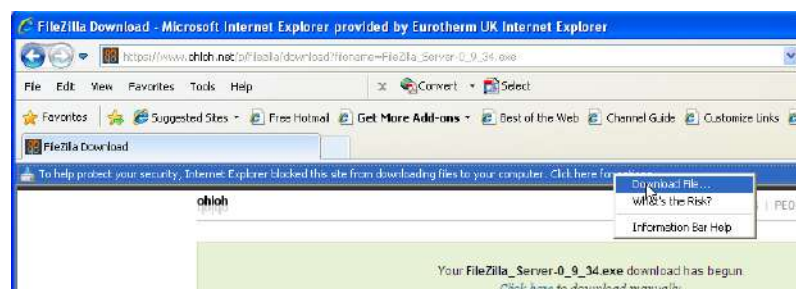

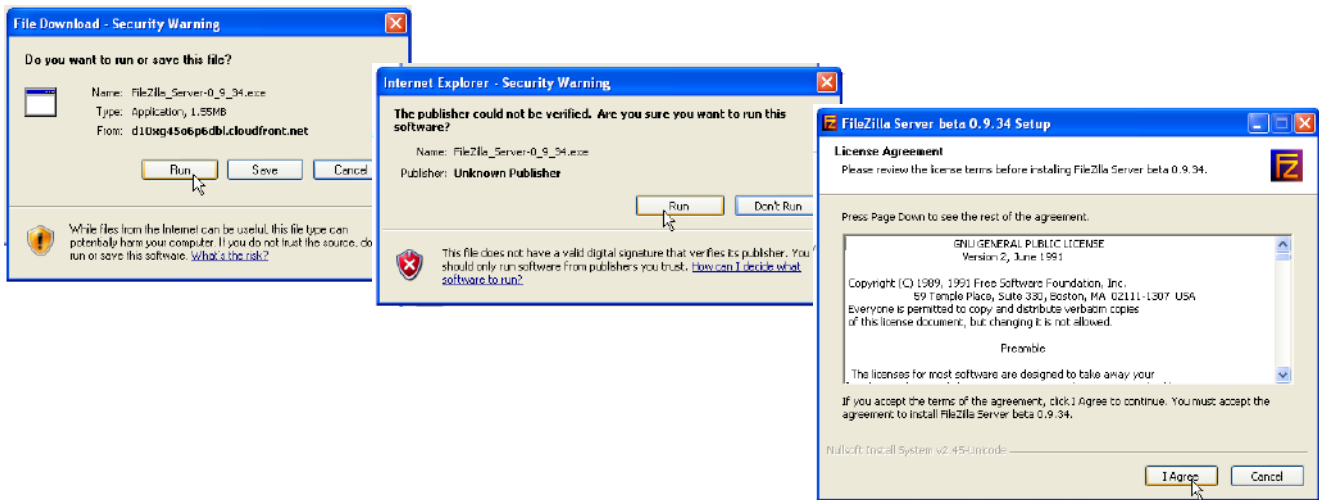

6. Agree or cancel the License agreement. If 'Agree', choose 'Standard' as the type of install.

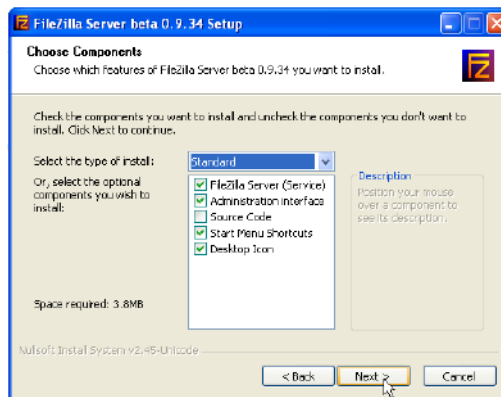

7. Choose the destination for the file.

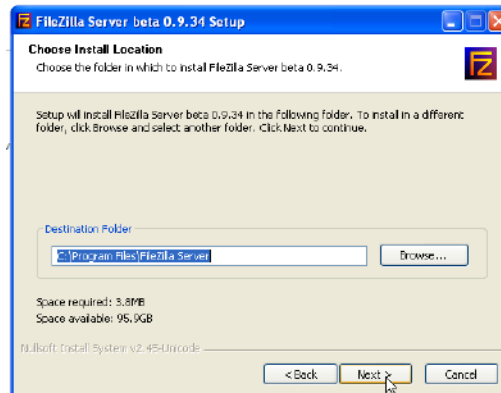

8. Select startup settings.

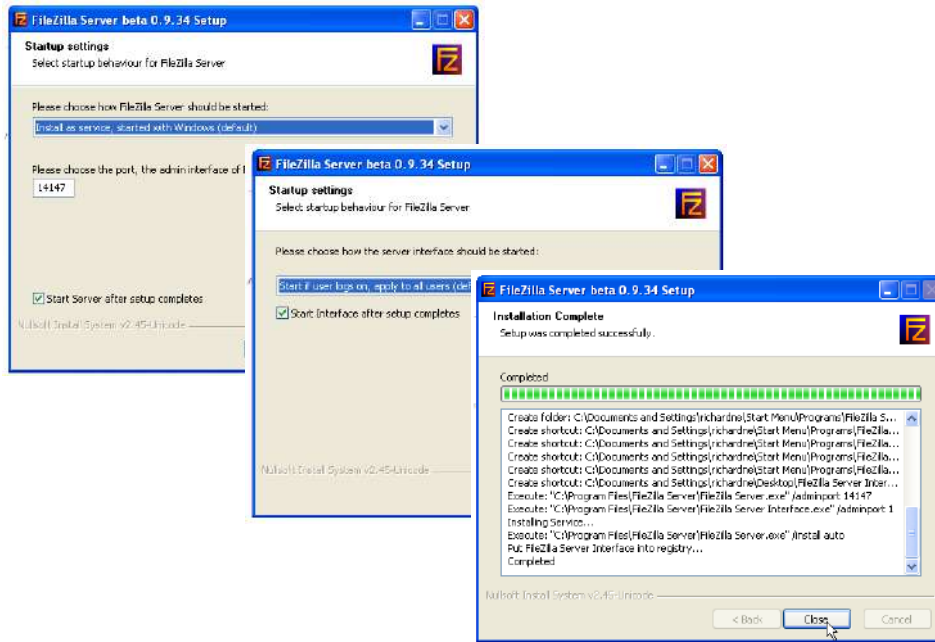

9. Click on Close when Installation is complete.

10. Click 'OK' in the 'Connect to Server' window.

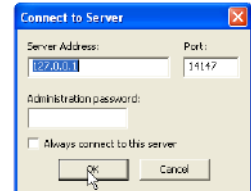

Server Setup

1. Create a new folder (directory) called, for this example, 'Archive' in a suitable location such as the C drive, or the desktop.
2. In the Filezilla server window, click on 'File' and select 'Connect to Server'.

The 'Logged on' message appears.

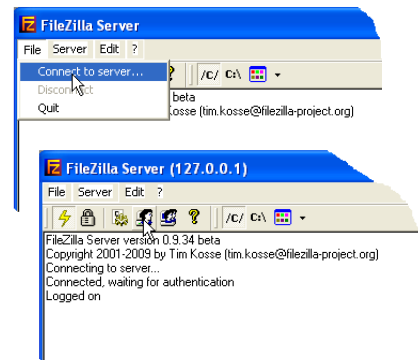

- In the Edit menu, select 'Users' and in the 'General' page, click on 'Add' and enter a name for the user, then click 'OK'. For this example, 'GeneralUser' has been used, but it may be more advantageous to use 'Anonymous' because this is the default name in the recorder/controller. Click on 'OK'.

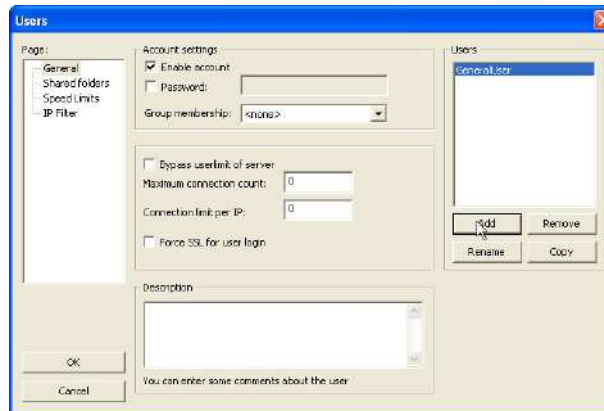

- In the Edit menu, select 'Users' and in the 'Shared Folders' page, click on 'Add'. A browse window opens allowing the user to select the new folder ('Archive') created in step 1, above. When OK has been clicked to confirm the selection, the new folder appears in the centre window (with an 'h' next to it to indicate that this is the home folder for this ftp user setup).

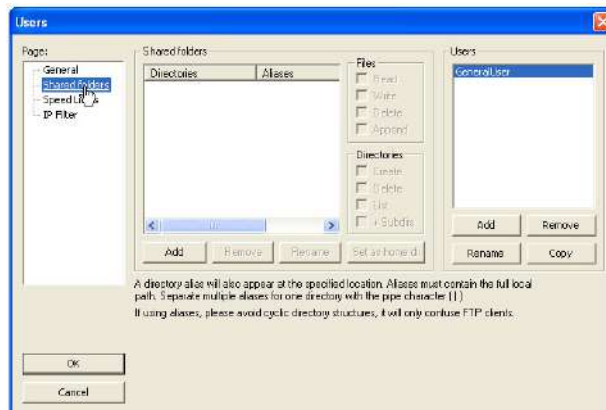

- Click on the relevant folder to enable the tick boxes. Click on all the 'File' and 'Directory' enable tick boxes, then click OK.

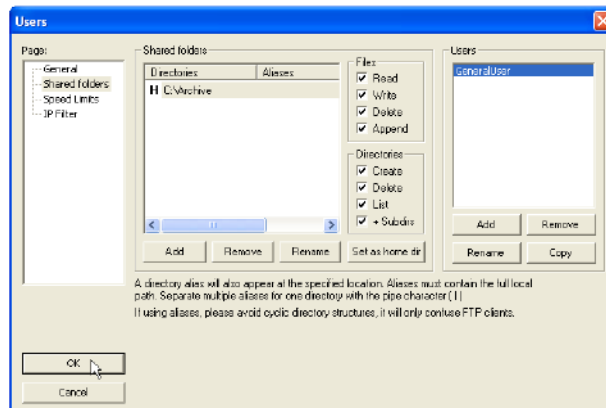

PC Setup

1. Operate the 'Start' button, and select 'Control Panel' from the window that appears. Double click on 'Windows Firewall'.

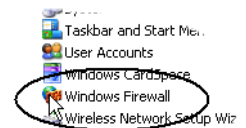

2. Click on the 'Exceptions' tab in the window that appears, and check that both 'FTPControl' and 'FTPData' are enabled (ticked). If not, the user's IT department should be contacted for advice.



3. Click on 'Add Program...' and browse to the Filezilla destination defined in step 7 of the download section ("Downloading" on page 431). Select 'FileZilla server.exe' and click on 'Open'.

'FileZilla server.exe' appears in the Exceptions list.



4. Click on 'OK'.



Recorder/Controller Setup

In Network Archiving ("Archiving" on page 111):

1. Enter the IP address of the pc in which the FTP server has been enabled in the 'Primary Server' field.
2. Enter the Primary User name, as entered in step three of the Server setup procedure ("Server Setup" on page 433) above (GeneralUser in this example).
3. Enter the IP address of another suitable pc which has been configured as an ftp server in the 'Sec. Server' field, and enter the relevant 'Sec. User' name.
4. Configure the other unattended archive parameters as required ("Archiving" on page 111).

Note: For the example above, 'Password' was not enabled in the User Accounts setup page ("Server Setup" on page 433), so for this example any Primary (Sec.) password entry is ignored. If a password had been entered in the User Accounts setup, then the Primary (Sec.) Password field would have to contain this password.

Archive Activity

Once a demand or unattended archive is initiated, the FileZilla Server page shows the activity status as the archive progresses. Figure 221 shows a typical page. The top of the page shows the transaction details between the server and any clients to which it is connected. The bottom portion shows details of the files currently being transferred. These files are archived to the 'Archive' folder.

The screenshot shows the FileZilla Server interface with a log of activity. The log includes the following entries:

```

(000014) 20/04/2010 10:01:12 - (not logged in) [149.121.132.60]: 220-written by Tim Kosse [Tim.Kosse@gmx.de]
(000014) 20/04/2010 10:01:12 - (not logged in) [149.121.132.60]: 220 Please visit http://sourceforge.net/projects/filezilla/
(000014) 20/04/2010 10:01:12 - (not logged in) [149.121.132.60]: USER GeneralUser
(000014) 20/04/2010 10:01:12 - (not logged in) [149.121.132.60]: 331 Password required for generaluser
(000014) 20/04/2010 10:01:12 - (not logged in) [149.121.132.60]: PASS ****
(000014) 20/04/2010 10:01:12 - generaluser [149.121.132.60]: 230 Logged on
(000014) 20/04/2010 10:01:12 - generaluser [149.121.132.60]: CWD
(000014) 20/04/2010 10:01:12 - generaluser [149.121.132.60]: 250 Broken client detected, missing argument to CWD: "/" is current directory.
(000014) 20/04/2010 10:01:12 - generaluser [149.121.132.60]: TYPE I
(000014) 20/04/2010 10:01:12 - generaluser [149.121.132.60]: 200 Type set to I
(000014) 20/04/2010 10:01:12 - generaluser [149.121.132.60]: PORT 149,121,132,60,192,104
(000014) 20/04/2010 10:01:12 - generaluser [149.121.132.60]: 200 Port command successful
(000014) 20/04/2010 10:01:12 - generaluser [149.121.132.60]: STOR Group-1~20100419_0190293000000062.uhh
(000014) 20/04/2010 10:01:12 - generaluser [149.121.132.60]: 150 Opening data channel for file transfer.
(000014) 20/04/2010 10:01:12 - generaluser [149.121.132.60]: 226 Transfer OK
(000014) 20/04/2010 10:01:12 - generaluser [149.121.132.60]: QUIT
(000014) 20/04/2010 10:01:12 - generaluser [149.121.132.60]: 221 Goodbye
(000014) 20/04/2010 10:01:12 - generaluser [149.121.132.60]: disconnected.
(000015) 20/04/2010 10:01:13 - (not logged in) [149.121.132.60]: Connected, sending welcome message...
(000015) 20/04/2010 10:01:13 - (not logged in) [149.121.132.60]: 220-FileZilla Server version 0.9.34 beta
(000015) 20/04/2010 10:01:13 - (not logged in) [149.121.132.60]: 220-written by Tim Kosse [Tim.Kosse@gmx.de]
(000015) 20/04/2010 10:01:13 - (not logged in) [149.121.132.60]: 220 Please visit http://sourceforge.net/projects/filezilla/
(000015) 20/04/2010 10:01:13 - (not logged in) [149.121.132.60]: USER GeneralUser
(000015) 20/04/2010 10:01:13 - (not logged in) [149.121.132.60]: 331 Password required for generaluser
(000015) 20/04/2010 10:01:13 - (not logged in) [149.121.132.60]: PASS ****
(000015) 20/04/2010 10:01:13 - generaluser [149.121.132.60]: 230 Logged on
(000015) 20/04/2010 10:01:13 - generaluser [149.121.132.60]: TYPE I
(000015) 20/04/2010 10:01:13 - generaluser [149.121.132.60]: 200 Type set to I
(000015) 20/04/2010 10:01:13 - generaluser [149.121.132.60]: PASV
(000015) 20/04/2010 10:01:13 - generaluser [149.121.132.60]: 227 Entering Passive Mode [149,121,134,223,5,199]
(000015) 20/04/2010 10:01:13 - generaluser [149.121.132.60]: STOR Group-1~$19-04-10-11-31-04~E------.csv
(000015) 20/04/2010 10:01:13 - generaluser [149.121.132.60]: 150 Connection accepted
(000015) 20/04/2010 10:01:13 - generaluser [149.121.132.60]: 226 Transfer OK
  
```

ID	Account	IP	Transfer	Progress	Speed
000018	generaluser	149.121.132.60	/Group-1~20100419_0190293000000058....	239,860 bytes	12.4 KB/s

Ready 393,439 bytes received 11,89 KB/s 5,593 bytes sent 0 B/s

Figure 221 FileZilla Server archive activity page

Function Block Details

Eight Input OR Block

An eight input logical OR block whose output is high (1, On) if any one or more inputs is high (1, On). If more than eight inputs are required, a second block is automatically introduced, as shown in [Figure 223](#). 1a. The blocks in the figure are given the names 'A' and 'B', where 'A' and 'B' can be any of the 12 available instances.

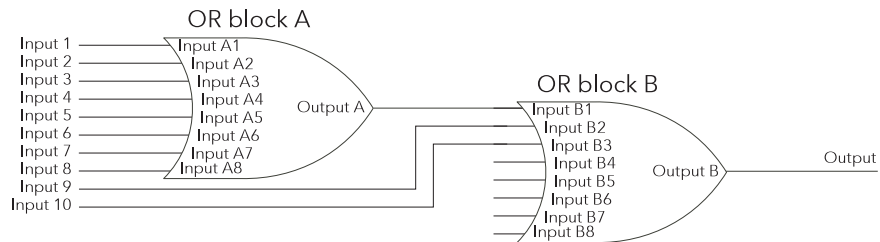

Figure 222 Eight input OR block

OR blocks are used automatically by the 'user wiring' when more than one source is wired to the same destination parameter. For example, it may be required that Relay (Digital I/O 2A2B) is to operate if channel 1 alarm 1 and/or channel 2 alarm 1 channels goes active. In such a case, the 'Active' parameter for the two channel alarms would be wired to the same relay's 'PV' parameter.

OR blocks are invisible to the user interface, but the iTools graphical wiring page for this configuration ([Figure 223](#).1b), shows that an OR block has been introduced to OR the two alarm outputs together.

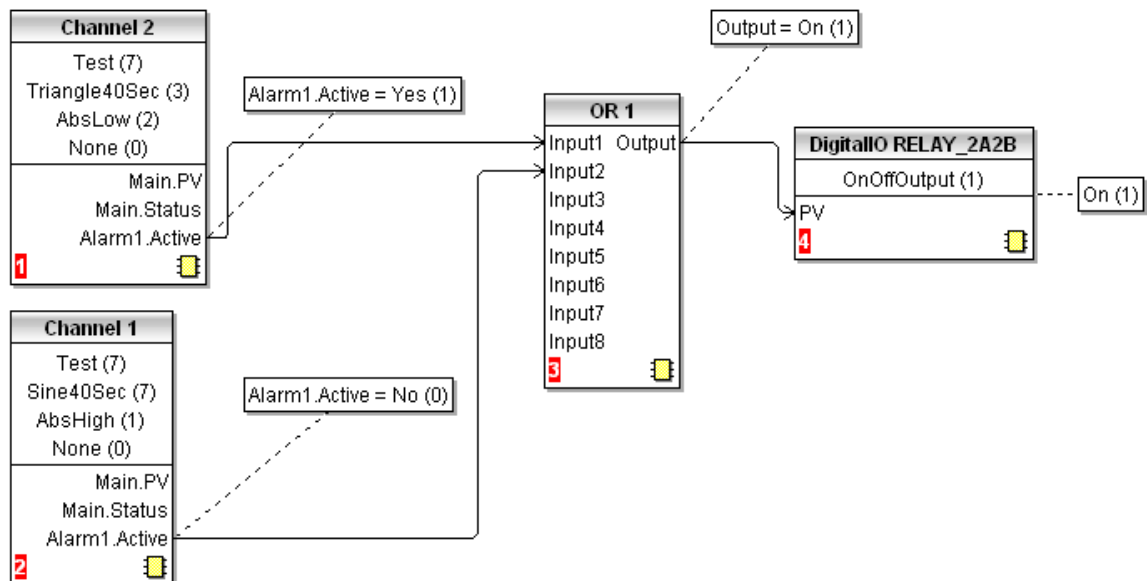

Figure 223 iTools representation of OR block usage

TCP Port Numbers

The following TCP ports are made use of by the instrument.

Port	Usage
20	File Transfer protocol (FTP) data
21	FTP control
502	Modbus TCP communications

Isolation Diagram

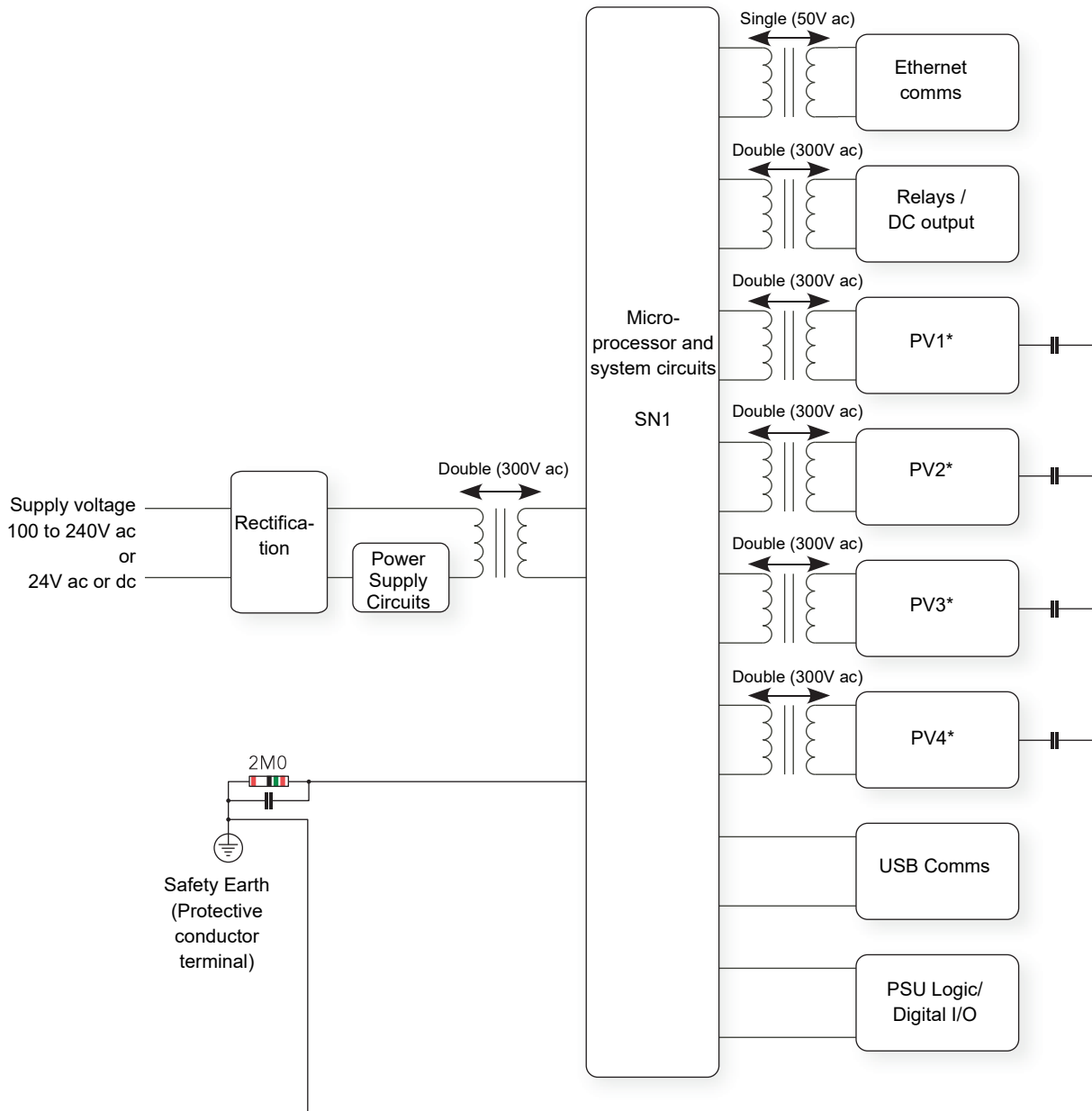

Figure 224 Isolation diagram

Note: Each 'PV' is double isolated (300VRMS) from all other 'PV's.

Appendix D: Web Server

The Web Browser has been added from firmware release V5.00.

Browsers

The following browsers are supported in the above firmware release:

- Google Chrome V22.0 or greater
- Google Mobile Chrome (Android Mobile technology running 'Ice cream sandwich' or greater)
- Internet Explorer V9.0 or greater
- Mobile Safari (Apple Mobile technology running IOS 5.0 or greater)

All files are uploaded from the nanodac device to the browser, where all JS and JQuery files are executed locally.

Browsers should be configured to allow cookies, and support for file caching should also be enabled.

If cookies are not enabled this will have the following detrimental effects:

- Any web page configuration changes 'saved' by the user in the client browser will not be retained when navigating between web pages
- For the most efficient browsing make sure that caching is enabled in the browser being used.
- Web server supports standard ASCII character set. Any non displayable characters will, therefore, be replaced by an asterisk '*'.

Connecting to the Internet

Open the desired web browser.

Enter the Ethernet address or other configured name of the instrument.

Note: The webserver requires up to 15 seconds before it becomes fully operational after it has been enabled.

Denied Page

This page will be displayed when there are no more available connections to the server. It does not use the same CSS theme as all other pages, so that this page does not rely on any other files being transferred up to the client browser, since to do this would require access to the server, which has just been denied.

Invensys Eurotherm - Web Server Login Failed

Maximum amount of sessions reached, please try again later

Copyright © 2012 - Invensys Eurotherm

Error Message

An error message can be displayed at any time if the following three conditions occur:

- A page fails to connect to the server. A retry will usually be sufficient to correct this condition.
- The server is in configuration mode. To correct this put the instrument into run mode.
- A page stops trying to connect. A refresh is usually sufficient to correct this condition.

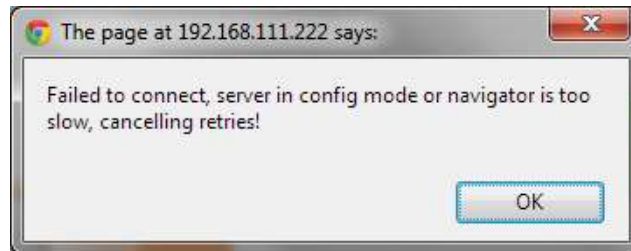

Home Page

The Home Page is the first page the user is directed to on completion of a successful log in.

If Security has been set to Yes in the instrument ([page 193](#)) it will be necessary to enter a User name and a Password.

The defaults are:

Username: admin

Password: None (password not required unless security has been set, see above)

These may be customised by the user up to 50 alpha/numeric characters.



About Page

This page contains the following target information:

- Instrument descriptor
- MAC address
- Application software version
- Bootrom software version
- Legal disclaimer

The screenshot shows the Invensys Eurotherm website's 'About Page'. The page features a navigation menu on the left with sections: GROUP, TRENDING, SUMMARY, and HISTORICAL. The main content area is titled 'Product Information' and contains a table with the following data:

Product Information	
Descriptor	nanodac
MAC Address	00:0A:8D:01:90:E1
Software Version	F4.22
Bootrom Version	V2.21

Below the table is a 'Legal Information' section with the following text:

The information contained within this Web Site, and those of all INVENSYS group companies linked hereto is provided purely for informational purposes regarding INVENSYS, its subsidiaries and partners and the services that they offer. It does not constitute an offer to sell any securities and must not be relied upon in connection with any investment decision.

INFORMATION ON THIS WEB SITE IS PROVIDED "AS IS" WITHOUT WARRANTY OR TERM OF ANY KIND, EITHER EXPRESS OR IMPLIED, INCLUDING, BUT NOT LIMITED TO, ANY IMPLIED WARRANTIES OR TERMS OF MERCHANTABILITY, FITNESS FOR A PARTICULAR PURPOSE, OR NON-INFRINGEMENT. ALL SUCH IMPLIED TERMS AND WARRANTIES ARE HEREBY EXCLUDED. BY ACCESSING THIS WEB SITE YOU AGREE THAT INVENSYS WILL NOT BE LIABLE FOR ANY DIRECT, INDIRECT OR CONSEQUENTIAL LOSS ARISING FROM THE USE OF THE INFORMATION AND MATERIAL CONTAINED IN THIS WEB SITE, OR ANY OTHER HYPERLINKED WEBSITE, INCLUDING, WITHOUT LIMITATION, ANY LOST PROFITS, BUSINESS INTERRUPTION, LOSS OF PROGRAMS OR OTHER, EVEN IF WE ARE EXPRESSLY ADVISED OF THE POSSIBILITY OF SUCH DAMAGES.

The above exclusions and limitations apply only to the extent permitted by law.

The copyright in the material contained in this web site belongs to INVENSYS, subsidiaries, divisions or its licensors.

Copyright © 2012 - Invensys Eurotherm

Contact Page

This page contains links to the following Eurotherm sites:

- Accredited Service
- Customer First & Technical Support
- Installation & Commissioning
- Repair & Support Services

The screenshot shows the Invensys Eurotherm website's 'Contact Page'. The page features a navigation menu on the left with sections: GROUP, TRENDING, SUMMARY, and HISTORICAL. The main content area contains the text: 'Invensys Eurotherm offer a full range of product and software services:' followed by four icons representing different services:

- Accredited Services
- Customer First & Technical Support
- Installation and Commissioning
- Repair and Support Services

Copyright © 2012 - Invensys Eurotherm

Bar Graph Page

The channels that have been configured to be trended on the nanodac instrument will automatically be displayed on this page. The current configuration data for those channels will be used to render the values on the graph.

The graph will always use the largest scale high and the lowest scale low of all the channels being rendered.

Click on a channel on the graph to display the current channel status. To remove this, click out of the graph again. The channel status will either be 'Ok' or 'Error' for all other error conditions.

All channels will be represented in their configured RGB colours. Colour matching will very much depend on the display the browser is running on.

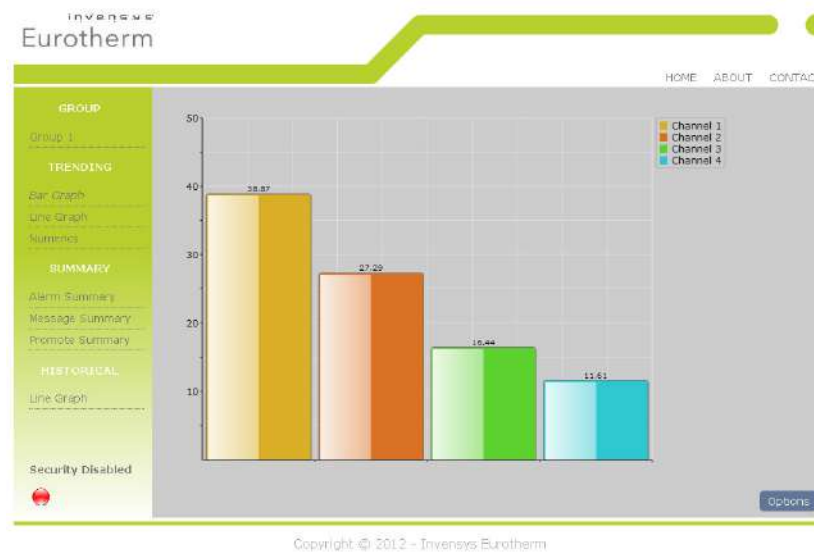

Options

The Options button allows the user some control over how the Bar Graph page is displayed.

All data is stored as cookies.

Graph Type	Gradient (as shown in the above display) Flat 3D
Legend	Show or Hide the Channel numbering legend in the top right hand corner
Background Type	Transparent or White
Gridlines	Show or Hide
Decimal Places	0 to 4
Value Alignment	Horizontal or Vertical
Plot Point	All (shows all available channels) Channel 1 only Channel 2 only Channel 3 only Channel 4 only

Graph Type	Gradient <input type="checkbox"/>
Legend	Show <input type="checkbox"/>
Background Type	Transparent <input type="checkbox"/>
Gridlines	Show <input type="checkbox"/>
Decimal Places	2 <input type="checkbox"/>
Value Alignment	Horizontal <input type="checkbox"/>
Plot Point(s)	All <input type="checkbox"/>

Line Graph Page

The channels that have been configured to be trended on the nanodac will automatically be displayed on this page. The current configuration data for those channels will be used to render the values on the graph.

The graph will always use the largest scale high and the lowest scale low of all the channels being rendered.

This graph is currently fixed at 100 samples. The first time that this page is opened it may take a little more time as the page will need to interrogate the web server for UHH history and render 100 samples of backfill.

As each new sample arrives the oldest historical sample is removed.

All channels will be represented in their configured RGB colours. Colour matching will very much depend on the display the browser is running on.

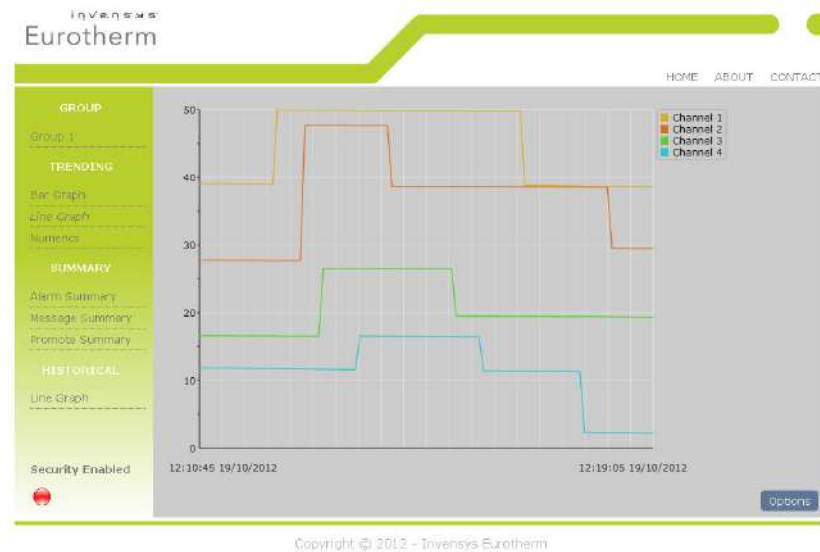

Options

The Options button allows the user some control over how Line Graph page is displayed.

All data is stored as cookies.

Plot Thickness	Narrow, Normal, Wide.
Legend	Show, Hide.
Background Type	Transparent, White.
Gridlines	Show, Hide.
Sample Period	1 second - 1 hour.
Plot Point	All, (shows all available channels) Channel 1 only Channel 2 only Channel 3 only Channel 4 only

Plot Thickness	Normal
Legend	Show
Background Type	Transparent
Gridlines	Show
Sample Period	5 Secs
Plot Point(s)	All

Numeric Page

This page displays the process value and channel descriptor.

The process value (PV) will not be displayed if the channel is not in a good status. Instead the text for the channel status is displayed as one of the following



Copyright © 2012 - Invenys Eurotherm

OFF	Channel is turned off
>RANGE	Over range
<RANGE	Under range
HW_ERROR	Hardware error
RANGING	Automatic range configuration (may appear briefly)
OVERFLOW	Value out of limits e.g. a maths channel may have returned a bad value
ERROR	Error, e.g. a maths channel divided by zero
NO_DATA	No data, e.g. nothing has been written to a Modbus input channel.

All channels will be represented in their configured RGB colours. Colour matching will very much depend on the display the browser is running on.

Options

The Options button allows the user some control over how Numerics page is displayed.

All data is stored as cookies.

Channel Font Size	Small, Normal, Large
PV Font Size	Small, Normal, Large

Alarm Summary Page

This page indicates if any process alarms are currently active

The screenshot shows the InvenSys Eurotherm web interface. The main content area is titled "Alarm Summary" and contains a table with the following data:

Channel Name	Alarm No	Threshold	PV	Type	Status
Channel 2	Alarm (2)	1.00 °C	-35.00 °C		Red alarm icon
Channel 2	Alarm (1)	1.00 °C	-35.00 °C		Red alarm icon
Channel 2	Alarm (2)	15.00 °C	5.99 °C		Red alarm icon
Channel 2	Alarm (1)	1.00 °C	5.99 °C		Red alarm icon

The left sidebar contains navigation options: GROUP (Group 1), TRENDING (Bar Graph, Line Graph, Numerics), SUMMARY (Alarm Summary, Message Summary, Promote Summary), HISTORICAL (Line Graph), and Security Enabled (green icon).

Copyright © 2012 - InvenSys Eurotherm

Status:

Red = Unacknowledged alarm.

Green = Acknowledged alarm.

Message Summary Page

This page provides the last 30 messages in chronological order

This page does not auto-refresh.

To refresh this page press  or go to another page and re-open the Message Summary page.

The screenshot shows the InvenSys Eurotherm web interface. The main content area is titled "Message Summary" and displays a list of messages:

- 22/10/12 12:02:53 Inactive: VCH1(A1) VCH1(A2)
- 22/10/12 12:03:07 Active: VCH1(A1) VCH1(A2)
- 22/10/12 07:58:07 Log In as: Supervisor
- 23/10/12 22:04:52 Inactive: VCH1(A1) VCH1(A2)
- 23/10/12 22:04:03 Active: VCH1(A1) VCH1(A2)
- 20/10/12 17:11:52 Inactive: VCH1(A1) VCH1(A2)
- 20/10/12 17:10:03 Active: VCH1(A1) VCH1(A2)
- 20/10/12 17:08:03 Inactive: VCH1(A1) VCH1(A2)
- 20/10/12 17:08:02 Active: VCH1(A1) VCH1(A2)
- 20/10/12 11:39:52 Inactive: VCH1(A1) VCH1(A2)
- 20/10/12 11:32:56 Active: VCH1(A1) VCH1(A2)
- 20/10/12 11:29:52 Inactive: VCH1(A1) VCH1(A2)
- 20/10/12 11:22:52 Active: VCH1(A1) VCH1(A2)
- 20/10/12 11:15:52 Inactive: VCH1(A1) VCH1(A2)

The left sidebar contains navigation options: GROUP (Group 1), TRENDING (Bar Graph, Line Graph, Numerics), SUMMARY (Alarm Summary, Message Summary, Promote Summary), HISTORICAL (Line Graph), and Security Enabled (green icon).

Copyright © 2012 - InvenSys Eurotherm

Promote Page

This page will show up to the 10 data items that have been configured by the user in the Promote page in the instrument display - see "Promote list" on page 77.

Parameter Name	Value
Descriptor	Channel 1
PV	27.5
Type	Abs. High
Threshold	1.0
Hysteresis	0.0
Acknowledge	No

Historical Line Page

The channels that have been configured to be trended in the nanodac instrument will automatically be displayed on this page. The current configuration data for those channels will be used to render the values on the graph.

The graph will always use the largest scale high and the lowest scale low of all the channels being rendered.

All channels will be represented in their configured RGB colours. Colour matching will very much depend on the display the browser is running on.

This graph is currently fixed at 100 samples, and the first time this page is accessed it may take a short time to load as the page will need to interrogate the web server for UHH history and render 100 samples of backfill.

Use the 'Previous Data' button to navigate back in time for up to a maximum of five time periods of history. If there is an end to the history event or a configuration change event, then the request to navigate back may result in only part of the trend being populated up to that event time.

Use the 'Next Data' button to navigate back to the point in time when the web page was entered.



Copyright © 2012 - InvenSys Eurotherm

Options

The Options button allows the user some control over how the Historical Line page is displayed.

All data is stored as cookies.

- Plot Thickness Narrow, Normal, Wide.
- Legend Show, Hide.
- Background Type Transparent, White.
- Gridlines Show, Hide.
- Sample Period 1 second - 1 hour.
- Plot Point All (shows all available channels)
 Channel 1 only
 Channel 2 only
 Channel 3 only
 Channel 4 only

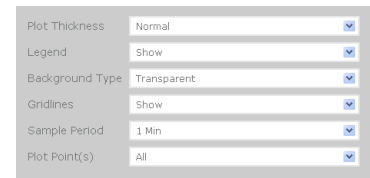

Status Icons

The Status icons are shown in the lower left of those pages that are automatically updated (i.e. not the Message Summary page).

They indicate the following:

Security Enabled or Disabled in the nanodac instrument.



Recording Status

Green shows recording enabled e.g. when the instrument is not in configuration mode.

Red shows recording disabled e.g. when the instrument is in configuration mode.



Any Channel Alarm Status. This flashes when any alarm is present, whether acknowledged or not.



Any new messages. Go to the Message Summary page to view any new messages. This icon is then removed from the other pages.



Any system alarm

Note: The update rate for the status icons is inherited from the current page.

DHCP Support

DHCP is managed in the web server in as much as the web server will not be allowed to come online until the nanodac has received a valid IP address. The server will continually monitor the IP address and, if at any point an invalid address is found, the server will shut down and re-start.

Network Protocols

The web server is in no way mutually exclusive with all other network protocols on the nanodac, however, to achieve the best results from the web server it is recommended that no other communication protocols are active at the same time.

Languages

The web server will only support English for all static text. Any channel descriptors or units that have been configured at the target in another language will be displayed in that language on all web pages where they are visible.

Appendix E: LabVIEW Driver

The purpose of this section is to describe how to download, install and configure examples of LabVIEW driver for nanodac instruments.

The driver is designed to integrate with LabVIEW, a graphical programming Environment developed by National Instruments. Labview allows users to create applications by wiring VI's from pre-existing libraries. VI stands for Virtual Instrument which are similar to function blocks found in Invensys Eurotherm products such as iTools or Lintools.

The user can also create their own Virtual Instruments (VIs), save them and reuse them on future projects.

For more information on LabVIEW go to <http://www.ni.com/labview/whatis/>.

Four working examples are available as free downloads by going to <http://www.eurotherm.com/labview/>. They are intended to show users how to use the nanodac driver to build applications.

Each example is a collection of VIs that perform specific tasks and use Ethernet TCP for communications.

It is not intended to describe how to configure a LabVIEW application as it is assumed that the reader is generally familiar with this process.

To find the examples select the Help menu and 'Find Examples' to open the 'Example Finder' page. In the search field, enter any of the following keywords nanodac, InvensysEurotherm, Eurotherm, Steriliser, Environmental, Chambers, Controller, Instrument or Driver and the corresponding examples will appear in the search results. Just select and double-click to open an example.

Application Example 1 - Heat/Cool Control

The "HeatCoolControl.vi" is an application example for Environmental chambers. The user can change the target setpoint, monitor temperature and instrument alarms.

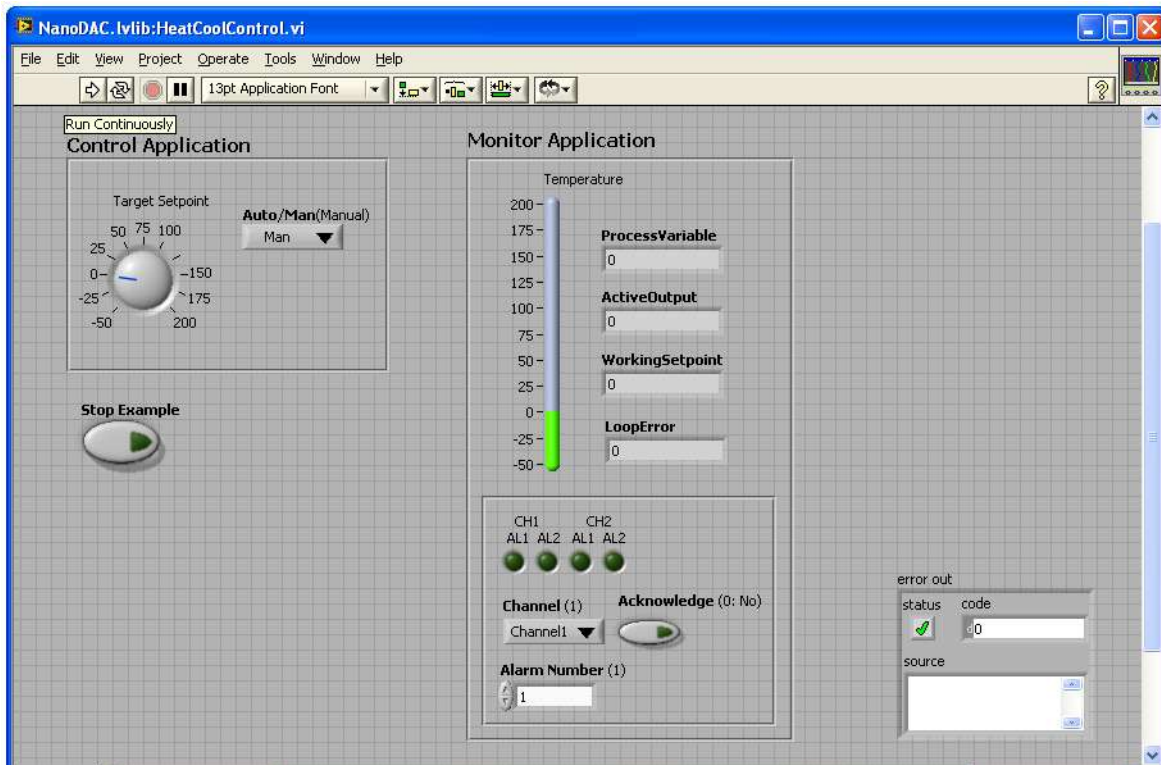

Figure 225 Heat/Cool Control Opening View

From the opening view, [Figure 225](#);

press Run 

Enter the IP address of the nanodac instrument.

Enter the Modbus address of the nanodac instrument. This depends on the setting of the Unit ident enable in the instrument;

If this is 'Strict' enter 255.

If this is 'Instrument' enter the Modbus address as set in the instrument from 1 to 99.

If this is 'Loose' then the ModbusTCP Unit Identity field does not have to match the instrument address. The instrument will respond to ANY value in the Unit Identity field.

Press 'Accept'.

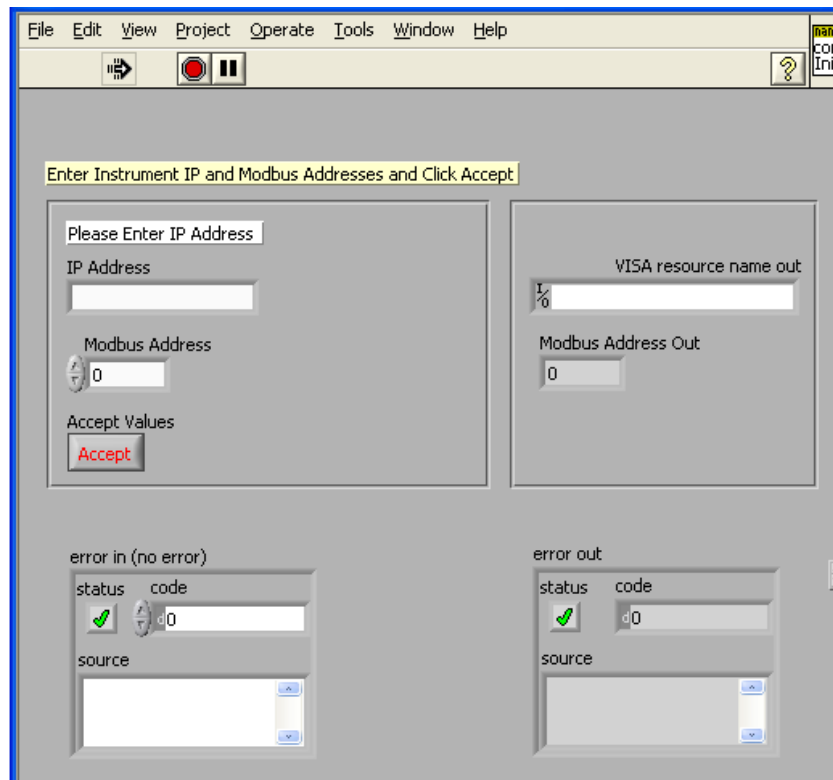

Figure 226 Enter Instrument Address

Note: Further information is available from the Help menu.

It is then necessary to select the firmware version which is supported for the instrument in use. Certain functions will not be available if the firmware version of the instrument is not in this list.

Press 'Current Folder'.

If a password has been entered in the instrument it will be necessary to enter this.

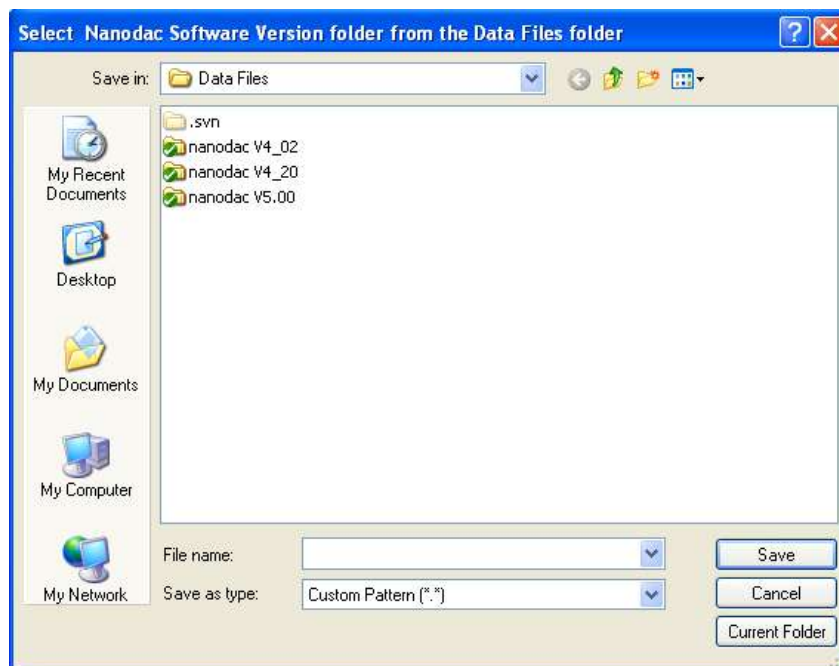

Figure 227 Data Files Folder

The application view then becomes live:

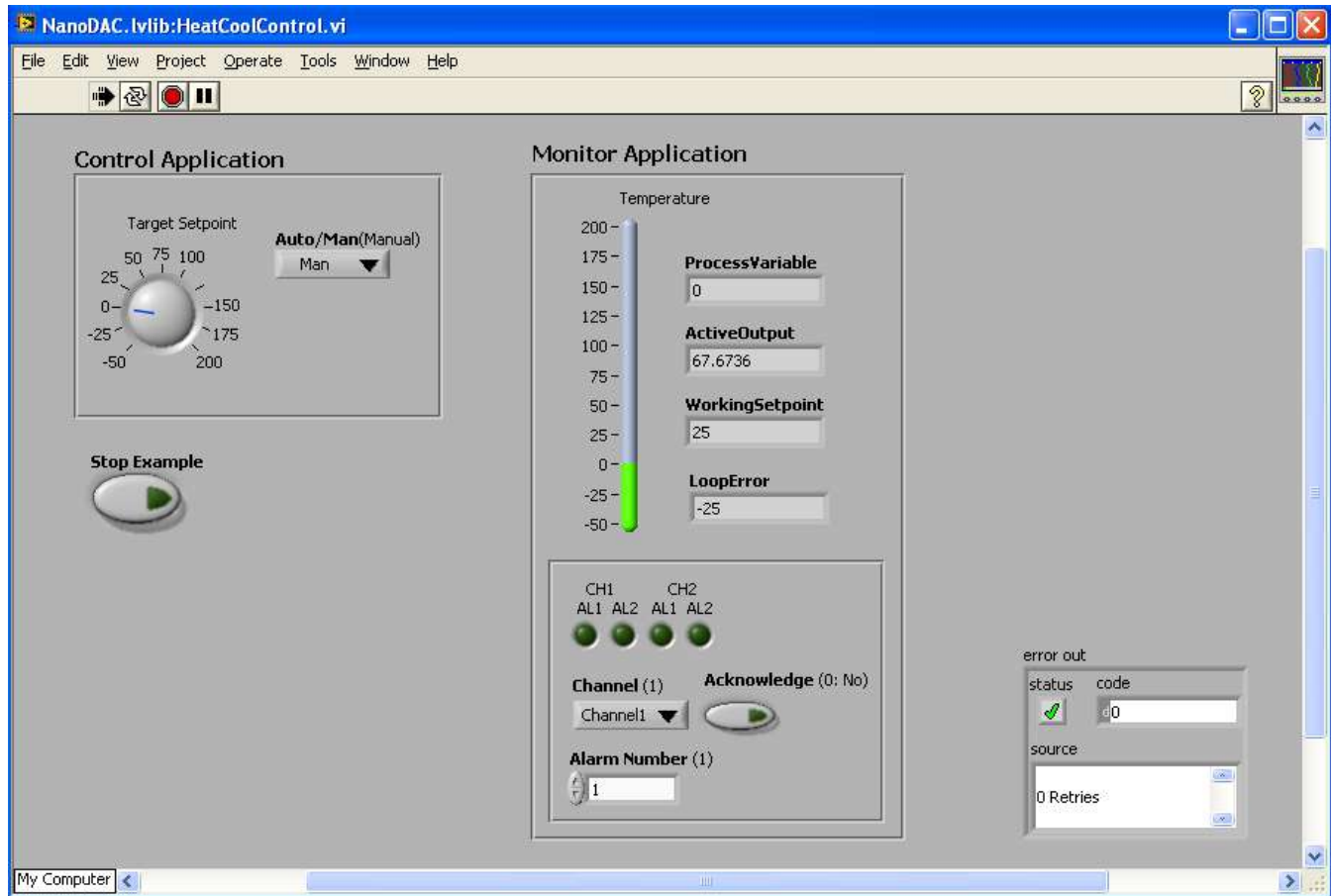

Figure 228 Heat Cool Live Application

The following parameters may be monitored/adjusted:

Target setpoint

- Select Auto/Manual and adjust the output power manually if in Manual.
- Monitor the current Process Variable, Active Output demand, Working Setpoint and Error.
- Monitor alarms. The alarm beacon turns red when an alarm occurs.
- Acknowledge alarms. Pressing the Acknowledge button acknowledges the selected alarm in the nanodac instrument. If the alarm is still active the alarm beacon remains red. If the alarm is no longer active the beacon reverts to its dark colour.

Application Example 2 - Program Load by Program Number

The "Program_LoadControl.vi" is an Application example which allows the user to load a program stored in the instrument using numbers, and to Run/Hold or Reset a preloaded Program.

This feature has been added in the nanodac instrument from firmware versions 5.00 and above.

To open and load this file, repeat the steps listed in Example 1.

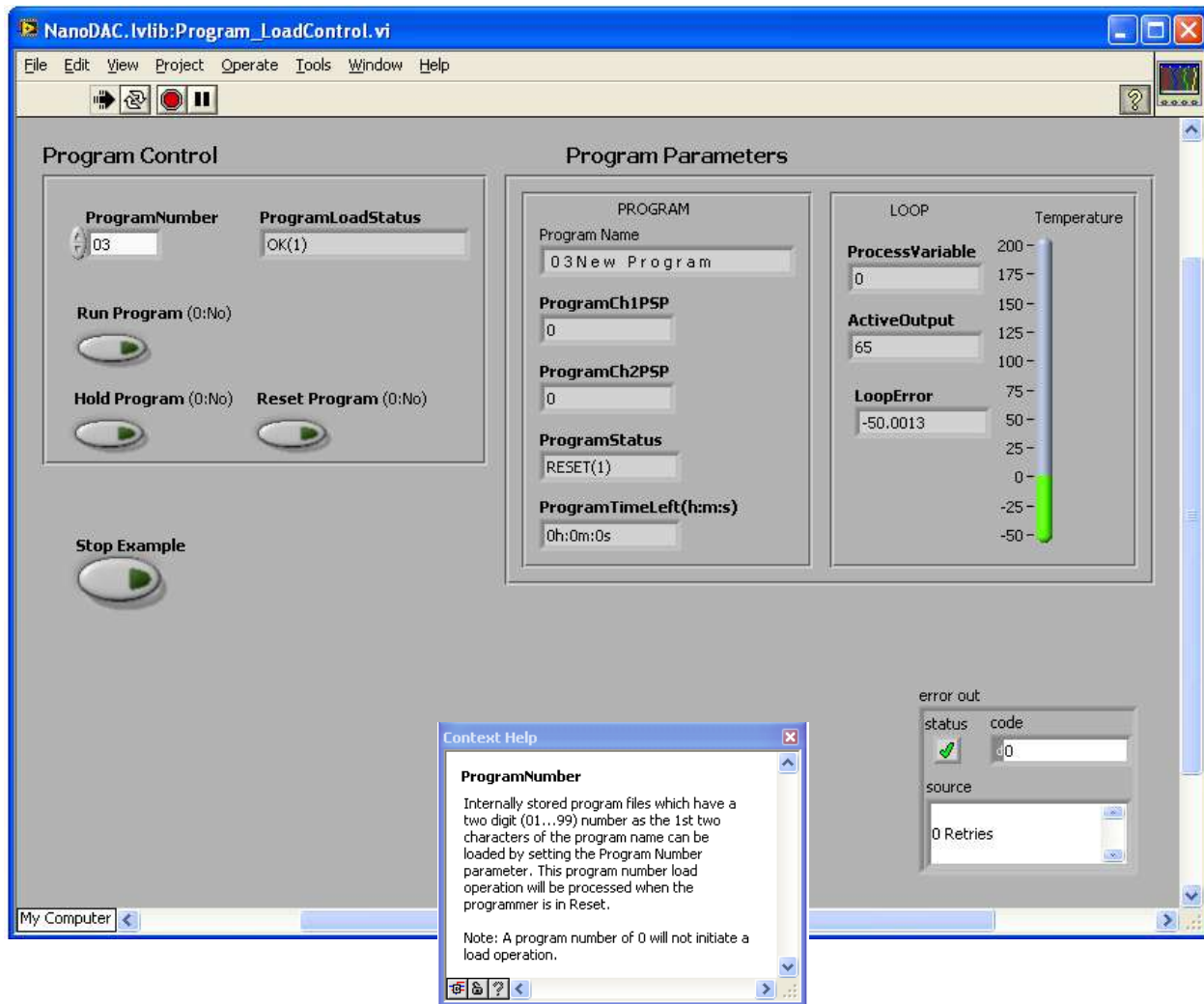

Figure 229 Program Load by Program Number (showing Context Help)

The following parameters may be monitored/adjusted:

- Select the Program Number. If the number entered is not available in the instrument it will not be recognised and an error message shown in the Program Load Status box
- Run/Hold/Reset the program
- Monitor the running program

Application Example 3 - Steriliser

The "Steriliser_Monitor.vi" is a Steriliser Application example allowing the user to control and monitor Sterilisation process parameters.

To open and load this file, repeat the steps listed in Example 1.

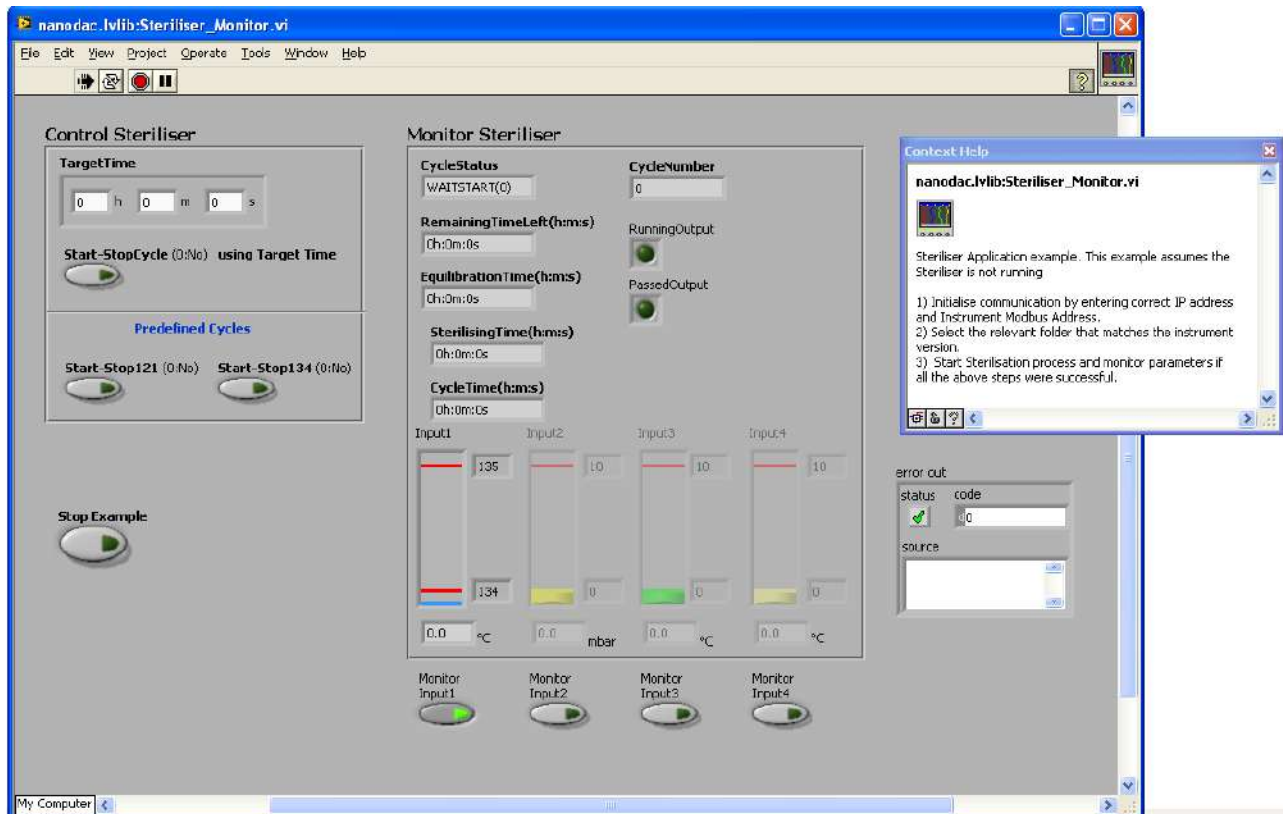

Figure 230 Steriliser Application (showing Context Help)

The following parameters may be monitored/adjusted:

- Start - Stop Predefined Cycles or Cycles using a target time
- Monitor the running steriliser cycle
- Monitor up to four input conditions. Any input can be selected by pressing the 'Monitor Input' button otherwise they are greyed out. Steriliser process limits are displayed for each input.

Application Example 4 - Configurable Steriliser

This application is the same as Example 3 but some configuration is allowable by the user such as input types and ranges.

Full driver capabilities list

As a general summary, with the nanodac Ethernet Labview Driver the user can:

- Configure SensorBreakType and Fault Response
- Configure Instrument Alarm Types
- Configure Alarm Parameters e.g. (Threshold, Hysteresis, Latching Mode, Blocking)
- Configure Channel Filter Time
- Configure Humidity parameters
- Configure Cool Type
- Configure FeedForward Parameters
- Configure Control Action
- Configure Control Loop Type
- Configure ServoToPV and Tracking
- Configure Range Low and High Limits
- Change Instrument Modes e.g. Operator, Configuration, Auto, Manual
- Configure Setpoints (Setpoint1, Setpoint2, Remote Setpoint, Target Setpoint)
- Configure Dead Band
- Configure hysteresis
- Configure Safe Output, Manual Output and ManStartUp
- Configure Control Output Limits.
- Configure Valve Operation
- Configure Proportional Band Integral Time and Derivate Time
- Configure Cutback Low and High Limits
- Configure Setpoint Low and High Limits
- Configure Setpoint Ramp Rate Value
- Configure Tuning parameters
- Configure PID Loop Break Time
- Configure Virtual Channel Timer Parameters
- Configure Virtual Channel Totaliser Parameters
- Configure Virtual Channel Counter Parameters
- Configure Steriliser parameters
- Read Working Setpoint and Working Output
- Read Alarm Output status
- Read Manual Output Value
- Read Process Variable and Measured Values
- Read Timer Status
- Read PID parameters

- Start an Autotune
- Global Acknowledge Alarms
- Set Active Setpoint (Setpoint1, Setpoint2)
- Set Controller Mode (Auto, Manual, OFF)
- Start Program (Reset, Run, Hold)
- Read Steriliser Parameters
- Read Program parameters