

**NORMA 6003/NORMA 6003+/
NORMA 6004/NORMA 6004+
Power Analyzers**

Users Manual



July 2019 Rev. 2, 3/20

© 2019-2020 Fluke Corporation. All rights reserved. Specifications are subject to change without notice.

All product names are trademarks of their respective companies.

LIMITED WARRANTY AND LIMITATION OF LIABILITY

Each Fluke product is warranted to be free from defects in material and workmanship under normal use and service. The warranty period is two years and begins on the date of shipment. Parts, product repairs, and services are warranted for 90 days. This warranty extends only to the original buyer or end-user customer of a Fluke authorized reseller, and does not apply to fuses, disposable batteries, or to any product which, in Fluke's opinion, has been misused, altered, neglected, contaminated, or damaged by accident or abnormal conditions of operation or handling. Fluke warrants that software will operate substantially in accordance with its functional specifications for 90 days and that it has been properly recorded on non-defective media. Fluke does not warrant that software will be error free or operate without interruption.

Fluke authorized resellers shall extend this warranty on new and unused products to end-user customers only but have no authority to extend a greater or different warranty on behalf of Fluke. Warranty support is available only if product is purchased through a Fluke authorized sales outlet or Buyer has paid the applicable international price. Fluke reserves the right to invoice Buyer for importation costs of repair/replacement parts when product purchased in one country is submitted for repair in another country.

Fluke's warranty obligation is limited, at Fluke's option, to refund of the purchase price, free of charge repair, or replacement of a defective product which is returned to a Fluke authorized service center within the warranty period.

To obtain warranty service, contact your nearest Fluke authorized service center to obtain return authorization information, then send the product to that service center, with a description of the difficulty, postage and insurance prepaid (FOB Destination). Fluke assumes no risk for damage in transit. Following warranty repair, the product will be returned to Buyer, transportation prepaid (FOB Destination). If Fluke determines that failure was caused by neglect, misuse, contamination, alteration, accident, or abnormal condition of operation or handling, including overvoltage failures caused by use outside the product's specified rating, or normal wear and tear of mechanical components, Fluke will provide an estimate of repair costs and obtain authorization before commencing the work. Following repair, the product will be returned to the Buyer transportation prepaid and the Buyer will be billed for the repair and return transportation charges (FOB Shipping Point).

THIS WARRANTY IS BUYER'S SOLE AND EXCLUSIVE REMEDY AND IS IN LIEU OF ALL OTHER WARRANTIES, EXPRESS OR IMPLIED, INCLUDING BUT NOT LIMITED TO ANY IMPLIED WARRANTY OF MERCHANTABILITY OR FITNESS FOR A PARTICULAR PURPOSE. FLUKE SHALL NOT BE LIABLE FOR ANY SPECIAL, INDIRECT, INCIDENTAL OR CONSEQUENTIAL DAMAGES OR LOSSES, INCLUDING LOSS OF DATA, ARISING FROM ANY CAUSE OR THEORY.

Since some countries or states do not allow limitation of the term of an implied warranty, or exclusion or limitation of incidental or consequential damages, the limitations and exclusions of this warranty may not apply to every buyer. If any provision of this Warranty is held invalid or unenforceable by a court or other decision-maker of competent jurisdiction, such holding will not affect the validity or enforceability of any other provision.

11/99

Table of Contents

Title	Page
Introduction	1
How to Contact Fluke.....	2
Safety Information.....	2
Preparation	3
Standard Equipment.....	3
Setup	5
Connect to the Power Supply	6
Charge the Battery.....	7
The Product	8
Control Panel.....	9
Display Screen.....	12
Status bar	13
Main Display Area	13
Soft Keys	13
Interface Panel.....	14
Operation	15
Global Configuration	15
Set Range.....	15
Motor Speed / Torque Channel Configuration.....	19
Set the Wiring Selection	20
Wiring Group	24
Set Sync Source and Update Rate.....	26
Zero	27
Define Calculation Formula	28
Meter.....	30
Preview	31
User Item View	32
Integration.....	34
Harmonic	35
Change View Mode	36
Select the Harmonics to Display.....	36
Harmonic Bar.....	37
FFT	38
Linear and Logarithmic Axis	39
Phasor	40
Select the Phasor Data to Display.....	42
Select Circuit Type	42
Zoom Phasor	42
Scope.....	43

Select the Waveform to Display	46
Trigger Setup	46
Measure with The Cursor	48
Zoom and Shift the Waveform	49
Trend	50
Select the Trend to Display	52
Set Measurement Period	53
Zoom and Shift the Trend	54
Data Management.....	55
Save Data	55
Logger	55
Auto Logger	56
Logger Interval	56
Dual-Unit Interconnection.....	59
Dual-Unit Interconnection Measurement	60
Connect the Computer	61
System Settings	62
General Settings	63
Language	63
Set Time and Date	63
Auto-Off.....	63
Memory	64
Set Communication Parameters	64
Remote.....	65
Instrument Maintenance.....	65
Calibration	66
Maintenance	66
Cleaning	66
Change the Battery	66
Change the Fuse.....	68
Firmware Upgrade	69
Specifications	70
General Specifications	70
Electrical Specifications	71
Voltage.....	71
Accuracy	71
Current.....	72
Accuracy	72
Motor (NORMA 6003+、NORMA 6004+).....	72
Frequency Domain Measurement.....	73
Appendix A	75
Measurement Calculation Method	75
How to Make More Accurate Measurements	80
Measurement Error Caused by the Channel Resistance.....	80
Effects of Leakage Capacitance	81
Broadband Measurement	82

Introduction

The Fluke NORMA 6003/NORMA 6003+/NORMA 6004/NORMA 6004+ Power Analyzers (the Product or Analyzer) are portable, precision wideband power analyzers. Use the product with the Fluke current clamp 80i-2010s and High Voltage Differential Probe U1500s for a broad range of electrical loads including those with electronic switching (inverter type).

The Product has these benefits:

- Up to 4 voltage and 4 current channels (NORMA 6003+, NORMA 6004+).
- Motor Speed and Torque measurements (NORMA 6003+, NORMA 6004+)
- 0.1 % accuracy, 500 kHz bandwidth, 200 kHz sample rate.
- The channels are isolated (basic insulation) with the measurement category of CAT III 1000V / CAT IV 600V.
- Flexible configurations according to the measuring requirements, synchronize 2 Analyzers to configure 6 to 8 channels.
- 9.6 cm thickness makes it easy to use in tight spaces.
- 5000 mAh Li-ion battery for 10 hours continuous operation with one single charge.
- CAT rating: CAT III 1000 V, CAT IV 600 V
- 100 ms to 1 s configurable update rate, 32 GB storage available for continuous logging.
- Main functions: Meter, Scope, Harmonic, Phasor and Trend.
- USB and RS485 interface with open communication protocol support user defined system integration and software.
- Simplified UI for better operation experience, suitable for in-field application.
- PC software (Fluke Power Analyzer Software) for online measuring, data downloading, and analysis.

Preparation

Standard Equipment

The Product is shipped in a container designed to prevent damage during shipment. Inspect the Product carefully for damage, and immediately report any damage to the shipper.

Figure 1 and Table 1 list the equipment and accessories included with this Product. For specific information on each part and more accessories, see the printed *Getting Started Manual* that ships with

Unpack the Product and check for all the standard equipment listed in Table 1 and check the shipping order for additional items ordered. Report any shortage to the place of purchase or to the nearest Technical Service Center.

If it is necessary to reship the Product, use the original container. If it is not available, you can order new packaging from Fluke by identifying the Product model and serial number.



Figure 1. Standard Equipment

Table 1. Standard Equipment

Item	Description	Quantity	
		NORMA 6004/6004+	NORMA 6003/6003+
①	Main unit, including battery BP291: 3894688	1	1
②	Power Supply Adapter (18V DC, CAT IV 600V Adapter)	1	1
③	Power line cord (for China): 4894155 Power line cord (for international): 4894137 Mains Adapter set (for international): 4894143	1	1
④	Test lead set 4-channel model: Test leads, 1.5 m, (4) red, (4) black, (4) blue Test leads, 0.18 m, (8) blue Alligator clips, (4) red, (4) black, (4) blue 3-channel model: Test leads, 1.5 m, (3) red, (3) black, (3) blue Test leads, 0.18 m, (6) blue Alligator clips, (3) red, (3) black, (3) blue	1	1
⑤	USB (mini B) cable	1	1
⑥	RS-485/synchrony adapter (3.81 mm, black, 3 pin)	1	1
⑦	Speed / torque adapter (3.81 mm, black, 6 pin)	None/1	None/1
⑧	USB Flash Drive for PC SW, (contains User Manual)	1	1
Not Shown	Getting Started Manual	1	1
	Product Warranty and Certification (China only)	1	1
	Calibration Report	1	1
	QC certificate (for China only)	1	1

Setup

The Analyzer is portable and equipped with a tilt stand that allows the Analyzer to be placed on a flat surface for users to view the screen from a certain angle, as shown in Figure 2.

Note

Do not use the tilt stand to carry the Product.

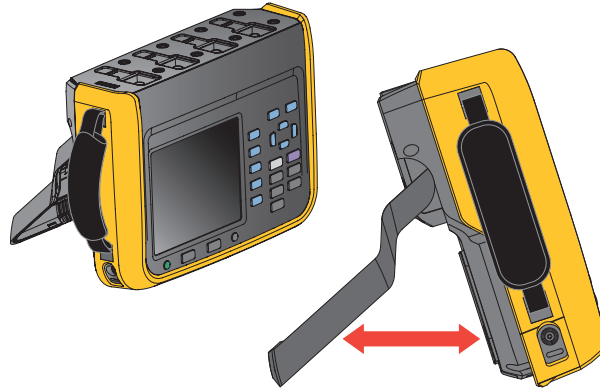

Figure 2. Use the tilt stand

Install the supplied hand strap on the left side of the Product. Adjust the handstrap, as shown in Figure 3.

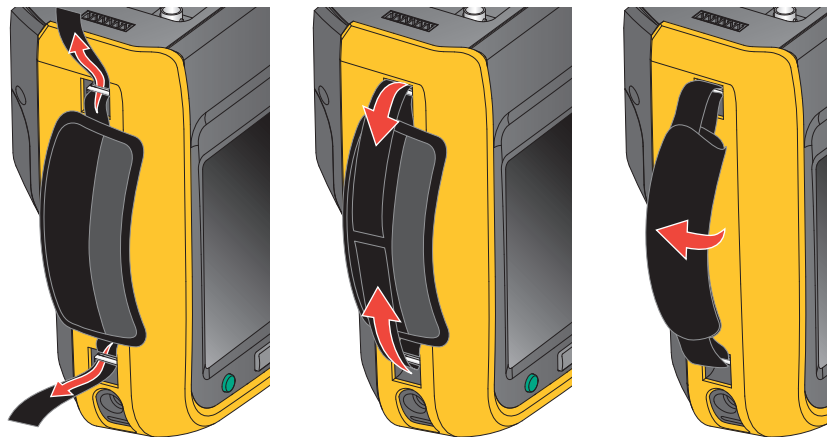

Figure 3. Install the hand strap

You can hold the Product in one hand when working and use the hand strap to carry the Product when the Product is not in use.

Connect to the Power Supply

Connect the Analyzer to a standard AC power supply according to [Figure 4](#) and turn on the Analyzer:

1. Connect the connector end of the power cord to the power adapter/charger and insert the plug into a standard wall outlet.
2. Open the protective cover and insert the power adapter/charger plug into the power jack on the Analyzer.
3. Push **ⓘ** on the front panel to turn on the Analyzer.

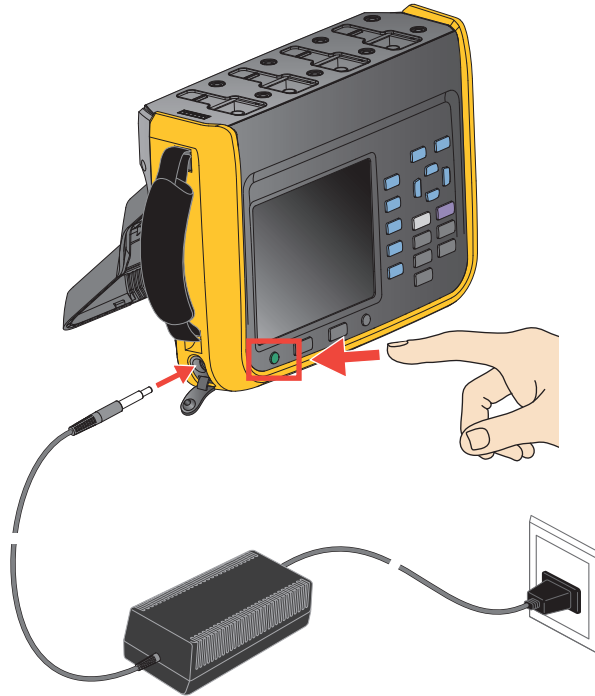



Figure 4. Connect to the Power Supply

⚠️⚠️ Warning

To prevent electric shock, connect the Product to a standard outlet using a factory-supplied power cord.

Charge the Battery

Before you use the Product for the first time, charge the battery.

When powered by a battery, the battery symbol at the top of the screen indicates the condition of the battery.  indicates low battery power, charge the battery immediately.

To charge the battery and power the instrument, connect the power adapter as shown in [Figure 5](#). To increase the battery charging speed turn off the Analyzer.



Figure 5. Battery Charging

 Caution

To prevent overheating of the battery during charging, do not charge in extremely hot or cold environments. If the battery is charged under extreme temperatures, the battery capacity may be reduced. Refer to charging temperature specifications.

Note

Charge the Product for a two-hour minimum at three-month intervals for maximum battery life. When not in use, the full charged battery will self-discharge in approximately six months. Batteries stored for long periods will need two to ten charging cycles for full capacity.

The Product

This section describes the operation panel of the Product and the location and function of the display. Please read this section carefully before operating the Product. This manual is applicable to many models. Because models have different features and accessories, not all of the information in the manual may apply to your Product.

Table 2 is a list of functional comparison of different models.

Table 2. Product Features Table

Feature	NORMA 6003	NORMA 6003+	NORMA 6004	NORMA 6004+
Number of channels for voltage / current	3/3	3/3	4/4	4/4
Motor speed / torque measurement	-	<input checked="" type="checkbox"/>	-	<input checked="" type="checkbox"/>
Basic accuracy	0.1%			
Bandwidth	500kHz (High voltage/current range)			
Sample rate	200 kHz			
Channel-to-channel isolation	<input checked="" type="checkbox"/>			
Meter (V / I / P / η etc.)	<input checked="" type="checkbox"/>			
Waveform	<input checked="" type="checkbox"/>			
Trend	<input checked="" type="checkbox"/>			
Harmonic	<input checked="" type="checkbox"/>			
Phasor	<input checked="" type="checkbox"/>			
CAT rating	CAT III 1000V, CAT IV 600V			
Ingress protection	IP50			
Color screen	5.7" backlight, 4:3			
Lithium battery	10.8 V/5000 mAh, 54 Wh			
Charging indication when power off	Charging: power indicator is orange Fully charged: power indicator is green			
Charger	Charging/powering			
PC software	<input checked="" type="checkbox"/>			
USB (device) – Mini B	<input checked="" type="checkbox"/>			
485 / sync interface	<input checked="" type="checkbox"/> (up to 921,600 bps)			
Low battery indicator	<input checked="" type="checkbox"/>			

Control Panel

Figure 6 and Table 3 list the features and function of each component on the control panel.

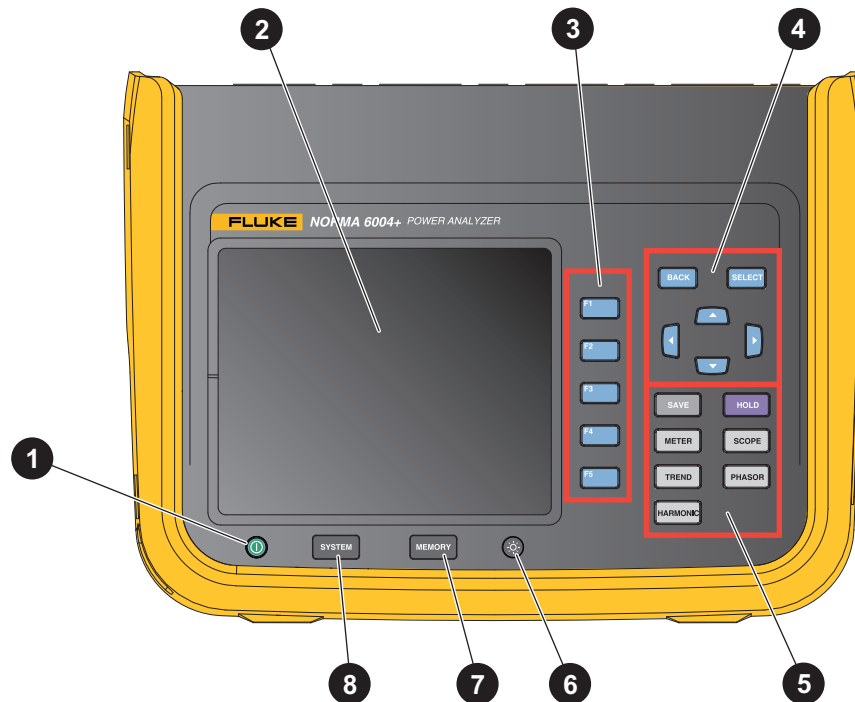

Figure 6. Control Panel

Table 3. Components on the Control Panel

Item		Description
1		<p>Power button</p> <p>The power button also indicates the AC power connection. If the indicator light is lit, when the Product is off, the AC power is connected. The button is orange when the battery is being charged and green when the battery is fully charged.</p> <ul style="list-style-type: none"> • Push to turn on/off the Analyzer. • Push and hold for 15 seconds to force the Analyzer to shut down.
2		<p>Screen</p> <p>See Display Screen.</p>

Table 3. Components on the Control Panel (cont.)









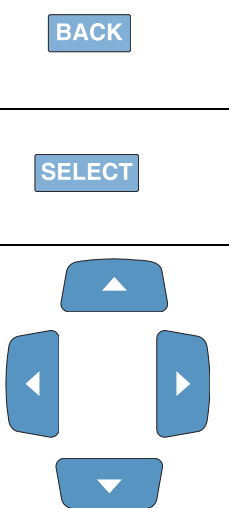

	Item	Description
3		<p>Function keys</p> <p>The F1 to F5 function keys correspond to the soft keys from top to bottom on the right next to the screen, the corresponding function keys are equivalent to the soft keys. The label of the soft key varies depending on the function and interface.</p>
4		<p>Back key</p> <p>Push BACK to exit the current screen and return to the previous screen or the previous menu</p> <p>Select key</p> <p>When a function on the screen is selected (highlighted in yellow), push SELECT to select or enter the function.</p> <p>Arrow keys (up, down, left, and right)</p> <p>Push the keys to go through all selectable functions on the screen and select one of them, the currently selected function is highlighted in yellow.</p>

Table 3. Components on the Control Panel (cont.)

Item	Description	
Interface buttons		
5		<p>Hold/Run</p> <p>Push HOLD, the Product freezes the reading on the screen and the screen will not refresh until you push HOLD again.</p> <p>Although the screen is frozen, the Product continues to measure.</p>
		<p>Save/Logger</p> <ul style="list-style-type: none"> • Short push: Save the current data or settings of the Analyzer. • Push and hold for 2 seconds: Enter the logger mode to continuously log the measurements of the current screen (for Meter mode only). <p>See Data Management for details.</p>
		<p>Meter</p> <p>Enter Meter Mode. See Meter for details.</p>
		<p>Scope</p> <p>Enter Scope Mode. See Scope for details.</p>
		<p>Trend</p> <p>Enter Trends Mode. See Trend for details.</p>
		<p>Phasor</p> <p>Enter Phasor Mode. See Phasor for details.</p>
	<p>Harmonic</p> <p>Enter Harmonics Measurement Mode. See Harmonic for details.</p>	
6		<p>Backlight / Prt Scr (Print Screen)</p> <ul style="list-style-type: none"> • Short push: adjust the brightness of the backlight, which can be adjusted in multiple levels. • Push and hold for 2 seconds: capture the current screen and save it as a PNG format.
7		<p>Memory operation</p> <p>Manage data stored in internal memory. See Memory for details.</p>
8		<p>System setting buttons</p> <p>Instrument information, instrument settings, communication settings. See System Settings for details.</p>

Display Screen

The display is shown in Figure 7.

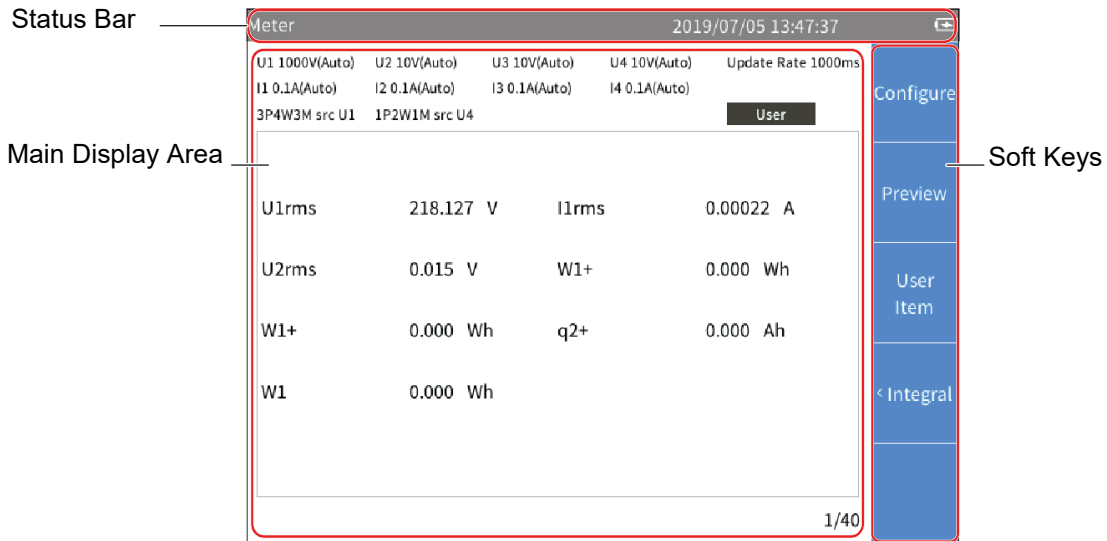







Figure 7. Display Screen

Status bar

Table 4. Status Bar



Item	Description
1	Menu navigation Displays the menu path of the current screen, for example: Configure > Wiring.
2	Clock Shows the current date and time of the Analyzer.
3	 or  Integration timer When integrating, the status bar shows the integral indicator. See Integration for details.
4	 or RS485 Indicates that the communication is connected.
5	Battery status Displays battery status. <ul style="list-style-type: none">  the charging indicator, this shows that the Product is connected to the main power.  the main power is not connected, and the vertical bar in the icon indicates the battery level.

Main Display Area

The main display area is the main display area of the screen for displaying various setting options, current measurements, charts and lists.

The main display area displays different content depending on the current interface mode and location, as detailed in the relevant sections below.

Soft Keys

The soft keys, at the right side of the display, have labels that will vary depending on the functions and interfaces. The soft keys correspond to the function keys (F1 to F5) on the right side of the screen.

If a soft key has no label, the key has no function.

Except for the main screen, the first menu item for the main measurement screens, **F1** is **Configure**, which is used for global configuration. Therefore, the function of the **F1** (**Configure**) key is not described again in the menus.

Interface Panel

Table 5 shows the connections on the interface panel.

Table 5. Connector Panel

The diagram shows a connector panel with four channels, each labeled 1 through 4. Each channel has a 'CURRENT' and 'VOLTAGE' section. Channel 1 has a protective cover (2) for the current input. Channel 2 has a '10A FUSED' current input. Channel 3 has an 'EXT SE NSOR' current input. Channel 4 has an 'EXT SE NSOR' current input. Each channel also has a 'VOLTAGE' input with 'HI' and 'LO' terminals. A separate section (6) is labeled 'TORQUE' and 'SPEED' with pins 1 through 6. Pin 1 is for torque analog, pin 2 is common for torque, pin 3 is for speed analog or pulse A, pin 4 is for speed pulse B, pin 5 is for speed pulse Z, and pin 6 is common for speed.

Item	Description	
1	Voltage/current input channel number	
2	Current port protection cover The protective cover can slide back and forth. When the protective cover slides forward, the external current sensor input port is exposed. When the protective cover slides back, the current input port is exposed.	
3	Voltage input port	
4	Current input port	
5	Input port for external current sensor	
6	Input port for motor speed / torque signal	
	Pin	Signal
	1	Input for torque analog quantity, 10 V range
	2	Common port for torque input
	3	Input for speed analog quantity, 10 V range or input for speed pulse, A pulse
	4	Input for speed pulse, pulse B
	5	Input for speed pulse, pulse Z
6	Common port for speed input	

Operation

Global Configuration

Under all view modes (Meter, Scope, Trend, Phasor and Harmonic), the soft key **F1** is **Configure**. The Configure soft key is global configuration and is applied to all other modes.

Use the Configure menu to set the range for each channel, timing synchronization, wiring, formula, zero and formula editing.

Enter the Configure Menu:

- From the Main screen of any view mode select **F1** (**Configure**).

The functions in the Configure menu are as shown in [Table 6](#).

Table 6. Global Configuration

Item	Description
F1 Range	Sets the voltage/current range for each channel, ratio, filter, and selects whether to use an external sensor. NORMA 6003+ and NORMA 6004+ can also set the mode and ratio of the motor torque/speed measurement. See Set Range for details.
F2 Wiring	Sets the wiring selection and the synchronization source of each wiring group. For detailed information, see Set the Wiring Selection .
F3 Timing Sync	Sets the sync source of each wiring group. For detailed information, see Set Sync Source and Update Rate .
F4 Zero	Eliminates the input offset by zeroing. See Zero .
F5 Formula	Defines the efficiency formula and the formula for some numerical calculation. See Define Calculation Formula for details.

Set Range

From the Main screen of any view mode:

1. Select **F1** (**Configure**) > **F1** (**Range**) > **F1** (**CH1**).

The Configuration interface of channel 1 is as shown in [Table 7](#).

Vol. Range is selected by default.

2. Push **SELECT** and use the up and down arrow (⏴ ⏵) keys to select the corresponding option. Then push **SELECT** again to confirm the option.
3. Use the up and down arrow (⏴ ⏵) keys to move the cursor to **Scale. Volt.**. Then push **SELECT**.
An input keyboard appears.
4. Use the arrow (⏴ ⏵ ⏴ ⏵) keys to move the cursor over the corresponding character on the keyboard, then push **SELECT** to enter the value into the input box at the top. Repeat until all characters are entered.





Note

For the characters on the keyboard:

$$k = \times 10^3 : m = \times 10^{-3} : \mu = \times 10^{-6} : M = \times 10^6$$



is the backspace key, which deletes the character before the cursor.

5. Use the up and down arrow ( ) keys to highlight **Ok** on the keyboard, then push **SELECT** to confirm the input value. To abandon your changes, select **Exit** on the keyboard and push **SELECT** or **BACK**.
6. Use the up and down arrow ( ) keys and **SELECT** to complete the configuration of the remaining items.
7. Push **BACK** to go to the Configure menu.
8. Push **F2** to set the range and ratio of CH1 to CH4.
9. Push **BACK** repeatedly to go back to the main screen.

  **Warning**

Set the parameters strictly according to the scale of external voltage divider, current shunt and current clamp. Otherwise, the measurement will not reflect the actual signal and there is danger of electric shock.

Note

The nameplate of the shunt or probe is usually marked with its parameter settings. Refer to the relevant information of the external sensor if necessary.

Note

The 10 kHz anti-aliasing filter is in the measurement channel. The anti-aliasing filter is necessary to analyze Fast Fourier Transform (FFT) data correctly and can be used to ensure that the measurement bandwidth is much less than 1/2 sample rate to avoid signal aliasing.

650 Hz low-pass filtering is implemented by a digital filter that helps distinguish the synthesis frequency and carrier signals of the variable frequency system. Turn on this filter to easily observe the synthesis frequency of the frequency conversion system.

If measuring a 3-phase system, Fluke recommends that the line filter settings for each channel in the 3-phase system should be consistent.

The filter is off by default.

Table 7. Range Configuration

Item	Description
Vol. Range	Voltage range options: <ul style="list-style-type: none"> • Auto: Autorange. The Analyzer automatically selects the voltage measurement range with the best resolution. • 10 V • 100 V • 1000 V
Vol. Ratio (V/V)	Scale of an external voltage sensor (PT). After setting the scale of the external voltage sensor correctly, the Analyzer automatically calculates the actual voltage value of the measured signal based on the voltage scale and the measured value. The Vol. Ratio represents the voltage ratio of the external sensor. For example, when connecting the U1500s high-voltage probe with a voltage ratio of 4mV/V, which represents a voltage ratio of 4:1000, the Vol. Ratio (V/V) on the Analyzer should be set to 0.004. <div style="text-align: center;">  Warning </div> <p>If the voltage input terminal is not connected to an external voltage divider in series, set the scale to 1, otherwise the measured voltage will not be consistent with the actual voltage, and there is a danger of electric shock.</p> <p>If the voltage input terminal is connected with an external voltage divider in series, the actual voltage will be calculated according to the set scale.</p>
Vol. Line Filter	Voltage signal filter options: <ul style="list-style-type: none"> • OFF: No filter is used. • 650 Hz: Automatically turn on the line filter, and the cutoff frequency is 650 Hz. Use to observe the synthesis frequency signal of the frequency conversion system. • 10 kHz: Automatically turn on the line filter, and the cutoff frequency is 10 kHz. Use for anti-aliasing. <p>Inserting a voltage measurement circuit has a direct impact on the measurement of voltage and power. When the line filter is turned on, the measurements do not contain high frequency components. Noise from the frequency inverter or distorted waveform can be removed.</p>

Table 7. Range Configuration (cont.)

Item	Description
Cur. Range	<p>Current range options:</p> <ul style="list-style-type: none"> • Shunt: Auto, 0.1A, 1A, 10A (when "Ext. Sensor" is not selected) • Ext. Sensor: Auto, 0.1V, 1V, 10V (when "Ext. Sensor" is selected)
Ext. Sensor	<p>Choose whether to use an external sensor.</p> <p>When the external sensor is selected/deselected, you must reset the current range.</p> <p>If an external sensor is not selected, the current signal is directly connected to the current channel of 10A, and the current is measured via the internal shunt.</p> <p>If an external sensor is selected, the current is measured by connecting the current signal of external sensor output to the BNC interface.</p>
Cur. Ratio (A/A, V/A)	<p>Scale of an external current sensor (CT). After setting the scale of the external current sensor correctly, the Analyzer automatically calculates the actual current value of the measured signal based on the current scale and the measured value.</p> <p>The ratio settings are, A/A or V/A.</p> <p>If the internal shunt is selected, the current scale represents the ratio of the actual current (A) to the input current (A) on the shunt (that is A/A).</p> <p>If an external sensor (BNC) is selected, the current ratio represents input voltage (V) on the BNC port to the ratio of the actual current (A) of the connected sensor (expressed as mV/A).</p> <p>For example, when connecting a current sensor probe with an output sensitivity of 1 mV/A, which represents a 1:1000 ratio, the Cur. Ratio (V/A) on the Analyzer should be set to 0.001.</p>
Cur. Line Filter	<p>Current signal filter options:</p> <ul style="list-style-type: none"> • Off: No current filter is used. • 650 Hz: Automatically turn on the line filter, and the cutoff frequency is 650 Hz. Use to observe the synthesis frequency signal of the frequency conversion system. • 10 kHz: Automatically turn on the line filter, and the cutoff frequency is 10 kHz. Use for anti-aliasing. <p>Inserting a current measurement circuit has a direct impact on current and power measurements. When the line filter is turned on, the measurements do not contain high frequency components. Noise from the frequency inverter or distorted waveform can be removed.</p>

Motor Speed / Torque Channel Configuration

From the Main screen of any view mode:

1. Select **F1** (Configure) > **F1** (Range) > **F5** (Motor).
The Configuration interface of Motor Speed / Torque is as shown in [Table 8](#).
The **Mode** is selected by default (the drop-down menu is highlighted in yellow).
2. Push **SELECT** and use the up and down arrow (⏴ ⏵) keys to select the corresponding option. Then push **SELECT** again to confirm the option.
3. Use the up and down arrow (⏴ ⏵) keys to move the cursor to **Ratio**. Then push **SELECT**.
4. Enter the correct values on the keyboard by using the up and down arrow (⏴ ⏵) keys and push **SELECT**.
5. Use the up and down arrow (⏴ ⏵) keys to highlight the **Ok** button on the keyboard, then push **SELECT** to confirm the input value.
6. For the **Ratio** option of the torque, repeat step 3 to 5 to configure the torque ratio in V/Nm.
7. Use the arrow (⏴ ⏵ ⏴ ⏵) keys to move the cursor to the **Apply** button and push **SELECT**. The settings are not saved to the device if you do not select Apply.
8. Push **BACK** repeatedly to go back to the main screen.

Table 8. Motor Speed / Torque Channel Configuration

Item	Description
Speed	
Mode	<p>Speed signal mode options:</p> <ul style="list-style-type: none"> • 10V (default): Use for speed sensor for analog voltage output. If the sensor uses current, frequency or other analog output, it must be converted to voltage before input. • A: For encoders with single pulse, only the speed value is measured and recorded, the direction of rotation is not measured and recorded. • AB: For encoders with AB double-pulse, both speed value and direction are measured and recorded. • ABZ: For ABZ incremental encoder, both speed value and direction are measured and recorded.
Ratio	<p>Speed sensor ratio.</p> <p>When Mode is set to 10V, the ratio is in V/rpm, which indicates that how much voltage (V) it is related to the motor speed (rpm). The formula for the Analyzer to calculate the actual speed is as follows:</p> $\text{Speed} = \text{Voltage} / \text{Ratio}$ <p>When Mode is set to another option, the unit of the ratio is the number of pulses per revolution (PPR). The formula for the Analyzer to calculate the actual speed is as follows:</p> $\text{Speed (rpm)} = \text{Pulses per Minute} / \text{Ratio}$

Table 8. Motor Speed / Torque Channel Configuration (cont.)

Item	Description
Torque	
Mode: The torque input is -10 V to 10 V the supported input signals must be conditioned to operate within these limits. If the sensor has a current output this must be converted using a shunt resistor before applying to the input.	
Ratio	Torque sensor ratio. The formula for the Analyzer to calculate the actual torque is: Torque = Voltage / Ratio

Set the Wiring Selection

To measure the power of various single-phase or three-phase power, different wiring selections are required, and multiple channel combinations are used. For more information on the connections, see the *Getting Started Manual*, shipped with the product or available online.

The Analyzer provides these basic wiring selections:

- 1P2W1M, 1-phase 2-wire 1-meter
- 3P3W2M, 3-phase 3-wire 2-meter
- 3P4W3M, 3-phase 4-wire 3-meter
- 3P3W3M, 3-phase 3-wire 3-meter

Note

In the abbreviation of the wiring selection, letter "P" indicates "Phase", letter "W" indicates "Wire", letter "M" indicates "Meter", that is power meter (includes one set of voltmeter and ammeter).

1P2W1M

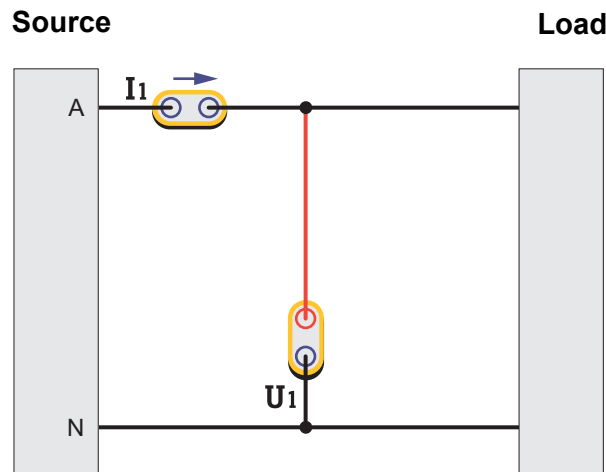

Figure 8. 1P2W1M Wiring

For 1P2W1M wiring, connect a voltage measurement channel between the phase line and the zero line. Connect a current measurement channel in series with the phase line or the zero line (note the direction) or clamped on the phase line or the zero line with a current sensor.

3P4W3M

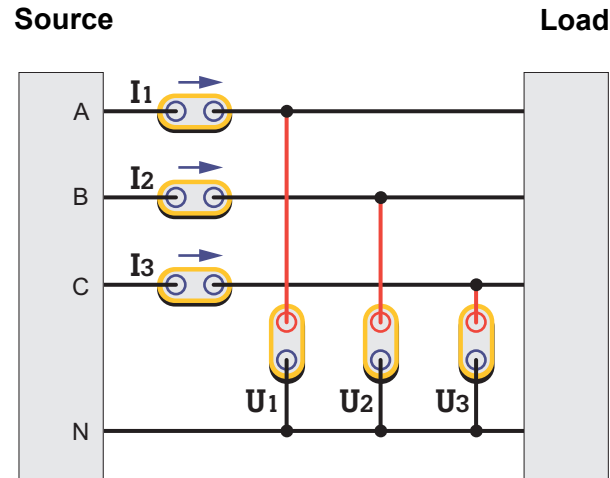

Figure 9. 3P4W3M Wiring

For 3P4W3M wiring, 3 voltage measurement channels are respectively connected between each phase line and the neutral line. 3 current measurement channels are respectively connected in series with each phase line or clamped on each phase line with a current sensor.

For systems without neutral lines, connect 3 voltage measurement channels between the 3 phase lines and the common ground line. For a 3P5W system, you can use a wiring group of 3P4W3M to measure the phase and neutral line. You can select one channel and configure it as 1P2W1M to measure the parameters between the neutral and ground line (NORMA 6004/6004+ only). If the ground and neutral lines do not exist, connect the common ends of the 3 channels together and suspend, and the total power measured is still valid.

For this wiring system:

1. The wiring system has the same impedance characteristics for 3 phases, a balanced measurement system can be established.
2. The wiring system has a terminal for neutral or ground, the common mode component input to the instrument is small, which reduces the effect of common mode components on the measurement results.
3. The phase voltage is directly measured, and the line voltage is calculated by Δ . It is more suitable for measuring systems of star connections.

3P3W3M

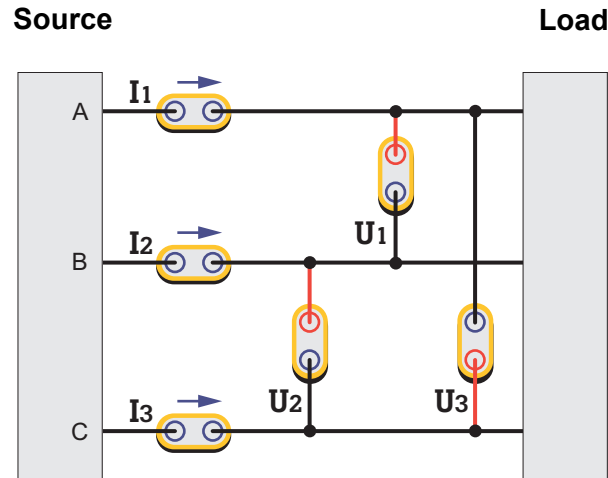

Figure 10. 3P3W3M Wiring

For 3P3W3M wiring, 3 voltage measurement channels are respectively bridged between 2 phase lines. 3 current measurement channels are respectively connected in series with each phase line or clamped on each phase line with a current sensor.

For this wiring system:

1. This wiring system has the same impedance characteristics for 3 phases, a balanced measurement system can be established.
2. When measuring the frequency conversion system with the power frequency input, this wiring system can appropriately eliminate the power frequency component in the frequency conversion signal, which is conducive to more accurately capturing the conversion frequency.
3. The line voltage is directly measured, and the phase voltage is calculated by Δ . It is more suitable for measuring systems of Δ connections.
4. The neutral line current can be measured by summing 3 current channel, but the neutral line voltage cannot be measured. When the neutral line voltage/neutral line current is present, the total power measured is also inaccurate.

3P3W2M

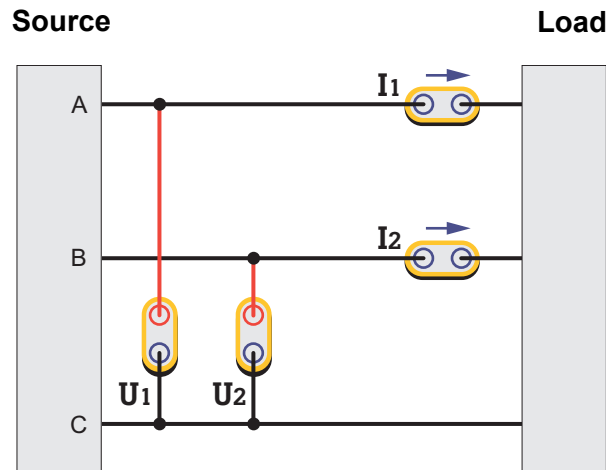

Figure 11. 3P3W2M Wiring

For 3P3W2M wiring, 1 phase line (C) is used as a common line, 2 voltage measurement channels are respectively bridged between the other 2 phase lines and this phase line. 2 current measurement channels are respectively connected in series to the other 2 phase lines, or a current sensor is clamped on the other 2 phase lines (Also known as two-wattmeter method or Aron method).

For this wiring system:

1. The wiring system can measure 3-phase system with only 2 channels, and 1-2 channels can be reserved for measuring DC, single-phase AC or 3-phase AC (simultaneous measurement of 2-channel 3-phase AC is only available for NORMA 6004/6004+).
2. When measuring the frequency conversion system with the power frequency input, this wiring system can appropriately eliminate the power frequency component in the frequency conversion signal, which is conducive to more accurately capturing the conversion frequency.
3. The system impedance for the 3 phases is different. The phase voltage and part of the line voltage are calculated by Δ . In addition, this wiring system cannot measure the voltage and current of the neutral line. When the neutral line voltage/neutral line current is present, the total power measured is also inaccurate.

Table 9. Wiring System Comparison

	3P4W3M	3P3W3M	3P3W2M
Number of channels occupied	3	3	2
Balanced test impedance	Yes	Yes	No
The power frequency components of frequency conversion systems can be eliminated	No	Yes	Yes
Phase voltage	Direct measurement	Indirect calculation	Indirect calculation
Line voltage	Indirect calculation	Direct measurement	Partial direct measurement
Common mode interference voltage inputted	Low	Moderate	High
Neutral line current measurement	Yes	Yes	No

Note

Where the current is measured may have some effect on the measurement results. To mitigate this effect, consider where the voltage and current are measured. For a signal with high voltage and low current, the voltage channel should be connected to the side that is closest to the source, the current channel should be connected in series (or the sensor should be placed) to the side that is closest to the load (as shown in the wiring diagrams). For a signal with low voltage and high current, connect the voltage channel to the side that is closest to the load, and connect the current channel in series (or the sensor should be placed) to the side that is closest to the source. Please refer to the appendix [Measurement Error Caused by the Channel Resistance](#).

Wiring Group

When you select a specific wiring selection, use a combination of 2 or more channels, which is called a wiring group.

For example, when the wiring selection of channel 1 is set to 3P3W2M, channel 1 and channel 2 form a wiring group.

Enter the Wiring Selection Configuration:

1. From the Main screen of any view mode select **F1** (Configure) > **F2** (Wiring).
2. The Configuration interface of wiring selection is as shown in Figure 12.

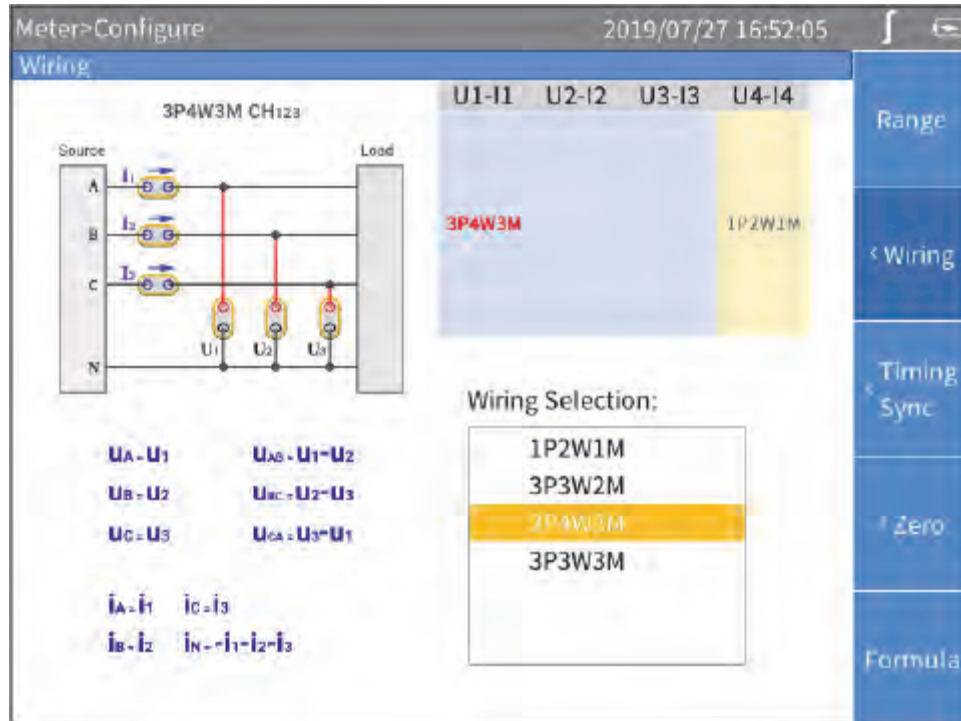

Figure 12. Wiring

Note

The optional wiring selection is related to the number of channels equipped with the Analyzer, and the interface of wiring selection will be different. Proper selection of wiring is conducive to ensuring more accurate measurements.

The wiring Configuration interface is generally divided into these parts:

- **Channel selection:** The upper right part shows the wiring group configuration of all 3/4 channels. Different wiring groups can be selected by using the left and right arrow (← →) keys. The name of the selected wiring group is highlighted in red.
- **Wiring selection:** The lower right part shows the wiring options supported by the currently selected channel. Use the up and down arrow (↑ ↓) keys to select the wiring mode of the corresponding channel.
- **Wiring diagram:** The upper left part shows the wiring diagram of the currently selected wiring mode in the "Wiring Selection".
- **Formula:** The lower left part shows the parameter calculation method of the currently selected "Wiring Selection".

Make a Wiring Selection:

1. In the **Wiring** screen (Figure 12), use the left and right arrow (◀ ▶) keys to select a channel or wiring group in **Channel Configuration**. The wiring selection of the selected channel/wiring group is highlighted.
2. Use the up and down arrow (⏴ ⏵) keys to select the appropriate wiring mode in **Wiring Selection**.
3. Push **SELECT**.
4. Use the arrow keys (◀ ▶ ⏴ ⏵) and **SELECT** to complete the configuration of the remaining items.
5. Push **BACK** to go back to the previous menu. Push the button continuously to go back to the main screen.

Set Sync Source and Update Rate

The sync source is a reference input signal, and the time interval of the measurement is determined according to the frequency of the selected sync source signal, and the sample values in this interval are used to generate measurements such as voltage, current and power, thereby ensuring calculation with the signal of the entire cycle to avoid measurement errors due to signal truncation.

1. From the Main screen of any view mode select **F1** (Configure) > **F3** (Timing Sync).

The setup interface of Timing/Sync is as shown in Table 10.

Table 10. Timing and Sync

Item	Description
Update rate	<p>The time interval at which the DSP calculates the data values.</p> <ul style="list-style-type: none"> • 100 ms • 200 ms • 500 ms • 1 s
Source	<p>The sync source of each wiring group.</p> <p>All channels in each wiring group can only share the same sync source. The available sync sources include voltage and current signals for all channels in the wiring group.</p>

Note

The wiring groups that can be configured in the interface depends on the wiring selection. See [Set the Wiring Selection](#) for details.

2. Use the up and down arrow (⏴ ⏵) keys to move the cursor to **Update Rate**.
3. Push **SELECT** and use the up and down arrow (⏴ ⏵) keys to select the corresponding option. Then push **SELECT** again to confirm the option.
4. Use the up and down arrow (⏴ ⏵) keys to move the cursor to the first wiring group in **Source**.
5. Push **SELECT** and use the up and down arrow (⏴ ⏵) keys to select the corresponding option. Then push **SELECT** again to confirm the option.

6. Use the left and right arrow (← →) keys and **SELECT** to select each of the remaining wiring groups one by one.
7. Push **BACK** to go back to the previous menu. Push **BACK** continuously to go back to the main screen.

Set Sync Source

When the Analyzer measures AC signals, most of the measurements are calculated using the full-cycle sampling method to reduce the truncation error. In this case, a channel needs to be selected as the sync source to determine the length of the entire cycle.

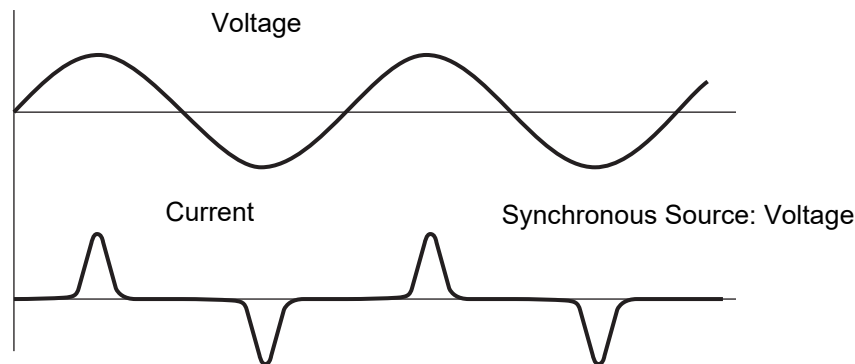

Figure 13. Set Sync Source

For each wiring group, you can select a sync source, and the voltage or current of any channel in the wiring group can be selected as the sync source. In general, the voltage of the power frequency system is more stable than the current. Fluke recommends using the voltage as the sync source. The voltage of the frequency conversion system has a large high-frequency component, while the high-frequency component of the current is relatively small. Therefore, when the current is relatively stable, the current can be selected as the sync source. However, if the current value is small or it is not stable, then the voltage should be selected as the sync source.

Zero

The function of zeroing is to reset the current value of the specified channel to calibrate the zero position of the Analyzer itself and the external sensor. The Analyzer supports zeroing each channel.

1. From the Main screen of any view mode select **F1** (**Configure**) > **F4** (**Zero**).
2. For each channel you want to zero:
 - a. Use the arrow (← →) keys to move the cursor to the option you want to zero,
 - b. Push **SELECT**, the selection box of the current item turns yellow and a black “x” symbol shows, indicating that it has been selected. If you push **SELECT** again, the selection box will be restored to blank, indicating that it is not selected.
3. Use the arrow (← →) keys to move the cursor to the **Zero** button and push **SELECT**.

Define Calculation Formula

The Analyzer allows the user to define efficiency and some numerical calculation formulas.

Define Efficiency Calculation Formula

The Analyzer allows the user to edit the efficiency calculation formula as needed.

1. From the Main screen of any view mode select **F1** (Configure) > **F5** (Formula) > **F1** (η).







The interface of calculation formula definition is as shown in [Table 11](#).

2. Use the up and down arrow (**↑** **↓**) keys to move the cursor to the numerator of the efficiency (η) formula. When the numerator portion turns yellow, push **SELECT**.

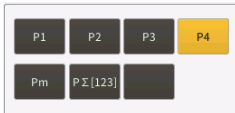
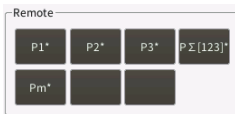
A keyboard shows on the screen.

The keyboard is divided into 3 parts: the top area shows all the measured parameters of the main unit, the middle “Remote” area shows the measured parameters of the remote slave unit in the dual-unit interconnection mode (in single unit mode, this area is gray and not selectable). The bottom area contains operators and buttons.

Table 11. Define Calculation Formula

Item	Description
	<p>Measured parameters from main unit</p> <p>This part of the keyboard lists all measurable power symbols for the Analyzer's current wiring selection. For the specific meaning of each parameter, refer to section Measurement Calculation Method in the appendix.</p>
	<p>Measured parameters from the slave</p> <ul style="list-style-type: none"> • The measured parameters of the remote slave unit in the dual-unit interconnection mode. • In single unit mode, this part is gray and cannot be selected. • For the specific meaning of each parameter, refer to section Measurement Calculation Method in the appendix.
Operators and buttons	
	Operators of addition and subtraction
	<p>Delete key</p> <p>Delete a symbol before the cursor.</p>
	<p>Clear key</p> <p>Clear all characters in the input box.</p>
	<p>OK key</p> <p>Accept the current input and go back.</p>
	<p>Exit key</p> <p>Go back and ignore this modification.</p>

- Use the arrow (⏪ ⏩ ⏴ ⏵) keys to move the cursor over the corresponding character on the keyboard, then push **SELECT** to enter the value into the input box at the top.
- Continue to use the arrow (⏪ ⏩ ⏴ ⏵) keys and **SELECT** to enter an expression that conforms to the efficiency calculation rule in the input box.

Note

During input process, if the input does not conform to the rules, the Analyzer will indicate the input is incorrect. Please double check that the input conforms to the efficiency calculation expression rules.

- Use the arrow (⏪ ⏩ ⏴ ⏵) keys to move the cursor to **OK** and push **SELECT**.
- For the denominator of the efficiency (η) formula, continue to use the arrow (⏪ ⏩ ⏴ ⏵) keys and **SELECT** to enter a formula.
- Push **BACK** to go back to the main screen.

Define hvf/hcf Calculation

hvf/hcf is a numerical measurement item used for measuring rotating motors according to IEC60034. It is necessary to configure the type of motor and rated voltage/current according to the actual test requirements.

- From the Main screen of any view mode select **F1 (Configure) > F5 (Formula) > F2 (hvf hcf)**.

The interface of calculation formula definition is as shown in [Figure 14](#).

In the hvf/hcf calculation page, the upper part is used to calculate hvf, and the lower part is used to calculate hcf.

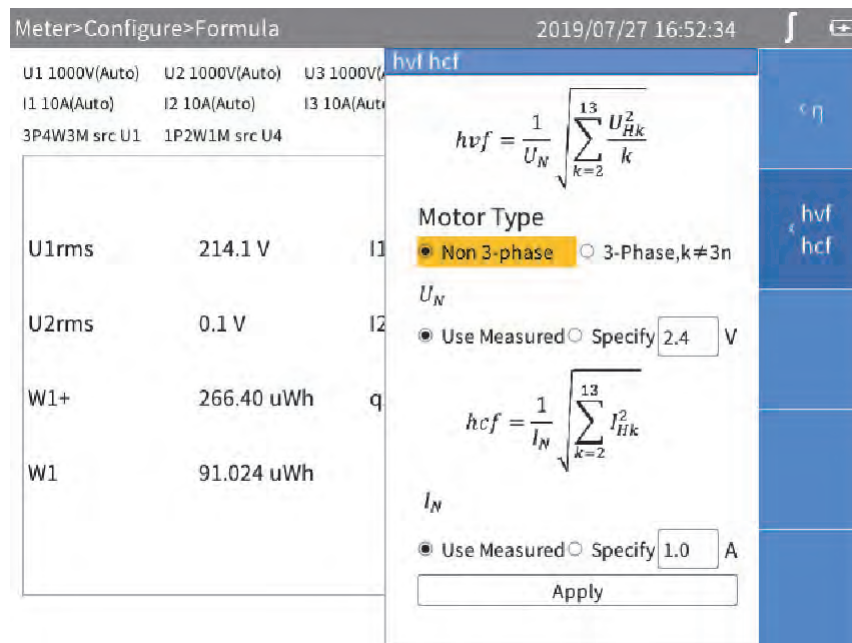

Figure 14. hvf/hcf Calculation Formula

- Use the arrow (⏪ ⏩ ⏴ ⏵) keys to move the cursor to Motor Type, select **Non 3-phase** or **3-phase, k≠3n** and then push **SELECT**.

3. Use the arrow (⏪ ⏩ ⏴ ⏵) keys to move the cursor to “U_N” (rated voltage) select **Use Measured** or **Specify** and then push **SELECT**.
 - o If **Use Measured** is selected, the measured voltage fundamental amplitude is used as the rated voltage.
 - o If **Specify** is selected, you can specify the rated voltage. Move the cursor to the corresponding input box, then push **SELECT**, and input the corresponding value using the on-screen keyboard, then move the cursor to **OK** key on the keyboard, and push **SELECT**.
4. Use the arrow (⏪ ⏩ ⏴ ⏵) keys and **SELECT** to enter the hcf settings.

For I_N,

 - o If **Use Measured** is selected, the measured current fundamental amplitude is used as the rated current.
 - o If **Specify** is selected, the rated current can be specified.
5. Use the arrow (⏪ ⏩ ⏴ ⏵) keys to move the cursor to the **Apply** button and push **SELECT**. The settings are not saved to the device if you do not select Apply.
6. Push **BACK** to go back to the previous menu.

Meter

When the Analyzer is turned on, it defaults to the **Meter** mode, and the current measurements are displayed in a list on the main screen.

You can also push **METER** to enter the **Meter** mode.

Table 12 lists the items displayed on the screen.

Table 12. Meter Screen

Item	Description
Range configuration information	Current range information for each module <ul style="list-style-type: none"> • The representation with (Auto) indicates auto range, which automatically switches the range according to the signal. • The representation without (Auto) indicates that the current range is fixed, the range of the value displayed and the range will not change with the signal.
Wiring configuration information	Current wiring selection for each wiring group.
Update rate	The current update rate of the Analyzer. See Set Sync Source and Update Rate .
Current state	<ul style="list-style-type: none"> • Preview: Currently in Preview mode. • User Item: Currently in User Item mode. • HOLD: Currently in data hold state. The value displayed in the value list area does not change with the actual signal.
Value List	The measurement items are displayed in a list according to the user's settings. See Preview and User Item View for details.

Table 12. Meter Screen (cont.)

Item	Description
Soft keys	<p>F1 (Configure): Global configuration, see Global Configuration.</p> <p>F2 (Preview): Enter Preview mode, see Preview.</p> <p>F3 (User Item): Enter User-defined Mode, see User Item View.</p> <p>F4 (Integral): Integration Operation, see Integration</p>
Bottom Bar	Displays the current page number.

Preview





In Preview mode, all currently available measurements are shown in a certain order on the screen.

Enter Preview Mode:

- From the Main screen of Meter select **F2** (Preview).



The Preview screen is as shown in [Table 13](#) and the state label shows **Preview**.

Table 13. Meter Screen - Preview

Item	Description
F1 Sort by Function	Push F1 (Sort by Func.) to sort the measurements by functions. The label of Sort by Func. is highlighted in dark blue.
F2 Sort by Channel	Push F2 (Sort by CHANNEL) to sort the measurements by channels.
F3 Display	<p>Displays the number of items</p> <p>The number of measurements shown on each screen up to 20 measurements:</p> <ul style="list-style-type: none"> 4 8 12 16 20
F4 	<p>Page up key</p> <p>When the number of measurements available exceeds the number of items displayed on each screen, the  and  keys can be used to scroll forward or backward to display more measurements.</p> <p>The page number of the current screen is displayed in the prompt bar at the bottom. "1/40" means there are 40 pages in total, and the current screen is page 1.</p>
F5 	<p>Page down key</p> <p>Page down key for scrolling backward to display next page.</p>

User Item View







The number of measurements can be very large depending on different wiring selection and the number of channels. Even if the maximum number of measurements is displayed on each screen, there could be dozens of screen pages.

The Analyzer features a User Item View function, which allows users to select up to 20 most interesting measurements and display them on a single screen, thus avoiding frequent use of the  and  keys. Enter User Item View:

- From the main screen of Meter select  (**User Item**).

The User Item view is as shown in [Table 14](#) and the data source label shows **User Item**”

Table 14. Meter Screen - User Item View



Item		Description
	Edit	Edit the current item Change the item selected at the current location.
	Add	Add measurements Add measurements at the end of the list. Up to 20 measurements can be added.
	Del	Delete the current item Delete the item at the current location.
		Move forward the currently selected item Moves the currently selected measurement forward by one position in the list. If the currently selected measurement is already at the top of the list, no action is taken when the button is pushed.
		Move backward the currently selected item Moves the currently selected measurement forward by one position in the list. If the currently selected measurement is already at the end of the list, no action is taken when the button is pushed.

Note

When you enter the User Item view for the first time, the default items are U1rms... U4rms, I1rms... I4rms dependent on models. You can add up to 20 measurements to the list.

The Analyzer can remember the User Item views. Even if the Analyzer is turned off, the list defined last time will be automatically displayed when you enter the User Item view next time.

Add Measurement Items

1. From the main screen of Meter, select  (**User Item**) >  (**Add**).

All available measurement items are listed by categories in a tree structure. See [Measurement Calculation Method](#) for details of measurement items.

2. For each measurement to add (up to 20 measurements):
 - a. Use **F1** through **F4** to select a category.
 - b. Use the arrow (**↖** **↗** **↘** **↙**) keys to move the cursor over the corresponding item.

In most cases, there are 2 dialog boxes displayed in the measurement tree menu, the one on the left lists measurement items, and the one on the right lists the supported channels or wiring groups. The yellow block represents the cursor position, and the yellow box indicates the corresponding branch in the current tree structure.

Note

Under Dual-Unit Interconnection mode, "Remote" option appears in this menu. See [Dual-Unit Interconnection](#) for details.

- c. Push **SELECT** to add the current option to the end of the list.

If the left and right dialogs are displayed, first select the name of the measurement item in the left dialog box, then select the channel or wiring group to be added in the right dialog box, and finally push **SELECT** to confirm.
3. Push **BACK** repeatedly to go back to the main screen of Meter.

Delete Measurement Items

1. From the main screen of Meter, select **F3** (**User Item**).
2. For each item to delete:
 - a. Use the arrow (**↖** **↗** **↘** **↙**) keys to move the cursor to the measurement item you want to delete.
 - b. Push **F3** (**Del**).
3. Push **BACK** to go back to the main screen of Meter.

Edit the Current Measurement Item

1. From the mains screen of Meter, select **F3** (**User Item**) > **F1** (**Edit**).
2. Use the arrow (**↖** **↗** **↘** **↙**) keys to move the cursor to the measurement item you want to edit.
3. Select the measurement item by following the operation similar to section [Add Measurement Items](#).

Unlike the section [Add Measurement Items](#), the measurement items added will directly replace the measurement items at the cursor position, instead of adding the newly added measurement to the end of the list.

Change the Position of the Measurement Item

You can sort the measurement items displayed in the User Defined view:

1. From the main screen of Meter select **F3** (**User Item**).
2. To move each item:
 - a. Use the arrow (**↖** **↗** **↘** **↙**) keys to move the cursor to the measurement you want to move.
 - b. Push **F4** (**↑**) or **F5** (**↓**).

Each time you push **F4** (▲) or **F5** (▼), the item at the cursor position moves forward or backward by one position.

3. Push **BACK** to go back to the main screen of Meter.

Integration

The Analyzer supports integral function to measure power energy, electric quantity and mechanical energy. The integral methods are:

- Manually start and stop:
 - o Push **F1** (**Start**) to start an integral,
 - o Push **F2** (**Stop**) key to stop the running integral
 - o Push **F3** (**Reset**) to clear the integral values.
- Auto start and manually stop:
 - o Set the auto start date and time and push **F4** (**Confirm**)
An integral starts automatically when the date and time is reached,
 - o Push **F2** (**Stop**) to stop the integral.
- Auto start and auto stop:
 - o Set the auto start date, time, and Duration and push **F4** (**Confirm**) (See Figure 15.)
An integral starts automatically when the date and time is reached, and stopped automatically after the Duration is complete.

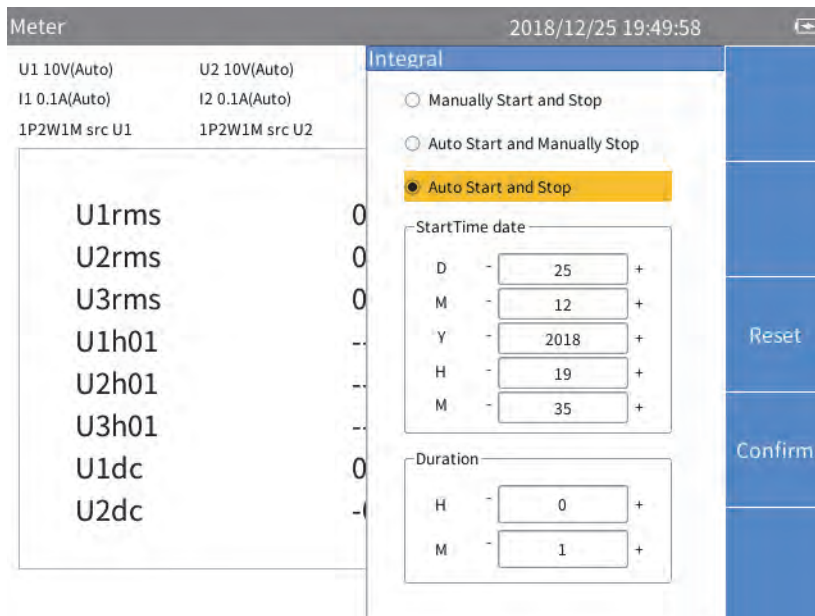

Figure 15. Auto Start and Auto Stop

Note

A settling time is required during the automatic range switching, and the sampled value during this time is not accurate, which will cause integral error. Therefore, in order to obtain accurate integration results, Fluke recommends setting the channel used for integration to manual range, and the range should cover the instantaneous voltage and current.

Harmonic

In HARMONIC mode, the user can analyze the signals in the form of a table/bar/FFT.

Enter Harmonic Mode

- From the main screen of current measurement screen select **HARMONIC**.

Table 15 lists the items displayed on the screen.

Table 15. Harmonic Screen

Item	Description
Items	The name of the currently selected items depends on the options in Item. See Select the Harmonics to Display for details.
Basic Frequency	The fundamental frequency (Hz) of the reference signal (sync source).
Total Harmonic Distortion	Total harmonic distortion of the voltage or current of the currently item, U_{thd} or I_{thd} . The unit is %.
Fundamental Content	Fundamental content of the voltage or current of the currently selected Item, U_{fc} or I_{fc} . The unit is %.
Harmonic Content	Harmonic content of the voltage or current of the currently selected Item, U_{hc} or I_{hc} . The unit is%.
Harmonic Voltage/Current Factors	Harmonic voltage or current factor of the currently Item, hvf or hcf.
Table, Bar and FFT	Displays table, bar or FFT depending on the selected display mode.
Soft Keys	<p>F1 (Configure): Global configuration, see Global Configuration.</p> <p>F2 (Item): Select the harmonic items displayed on the screen see Select the Harmonics to Display.</p> <p>F3 (Mode): Harmonic display mode. You can push this button to cycle through harmonic table, bar and FFT.</p> <p>F4 (▲ /Axis): Page Up key or Axis Setup key. It is the Page Up key under the table display mode, and it is the Axis Setup key under the bar and the FFT mode. See Linear and Logarithmic Axis.</p> <p>F5 (▼): Page Down, is used to scroll down the page to display more content.</p>
Bottom Bar	Displays the current page.

Change View Mode

- From the main screen of HARMONIC select **F3** (**Mode**). Cycle through the table, bar and FFT.

Select the Harmonics to Display

From the main screen of HARMONIC:

1. Select **F2** (**Item**).

The “Item” menu lists all currently available parameters, including voltage and current.

2. Use the arrow (**▼** **▶** **⏪** **⏩**) keys to move the cursor over the corresponding item.

3. Push **SELECT**.

Table 16. Harmonic Table

Item	Description
Harmonic Order	Harmonic Order
Magnitude	Harmonic magnitude, absolute value, in V or A.
Percentage	Harmonic percentage, relative to fundamental wave.
Phase	Harmonic phase angle, relative to fundamental wave.
Soft Keys	<p>F1 (Configure): Global configuration, see Global Configuration.</p> <p>F2 (Item): Select the harmonics displayed on the screen, see Select the Harmonics to Display.</p> <p>F3 (Mode): Harmonic display mode. You can push this button to cycle through harmonic table, bar and FFT.</p> <p>F4 (▲): Page up key. Each page can display 10 harmonics. When you need to view more harmonic data, use F4 and F5 to page up or down.</p> <p>F5 (▼): Page Down key, it is used to scroll down the page to display more content.</p>

Harmonic Bar

The harmonic bar is as shown in Figure 16 where the horizontal axis represents the harmonic order and the vertical axis represents the harmonic amplitude in V or A.

The harmonic bar of each screen shows 50 harmonics. The pages can be turned forward or backward through **F5** (Next Page) button to display more harmonic bar.

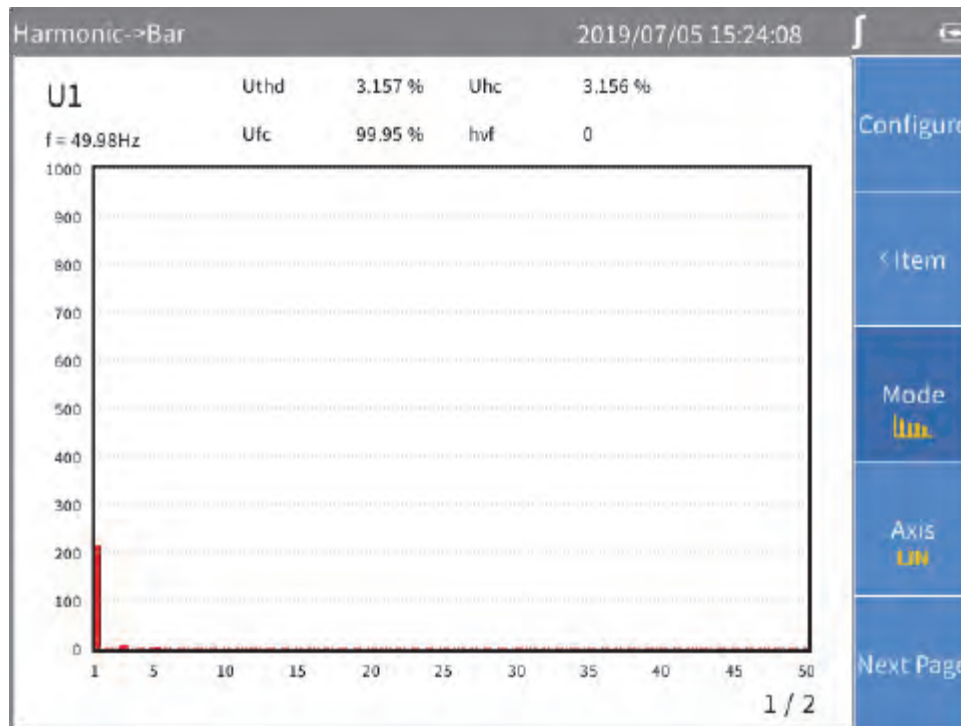

Figure 16. Harmonic Bar

FFT

The harmonic FFT is as shown in Figure 17, where the horizontal axis represents frequency and the vertical axis represents magnitude.

Use the left and right arrow (◀ ▶) keys to scroll the horizontal axis to see FFT curves in different frequency ranges.

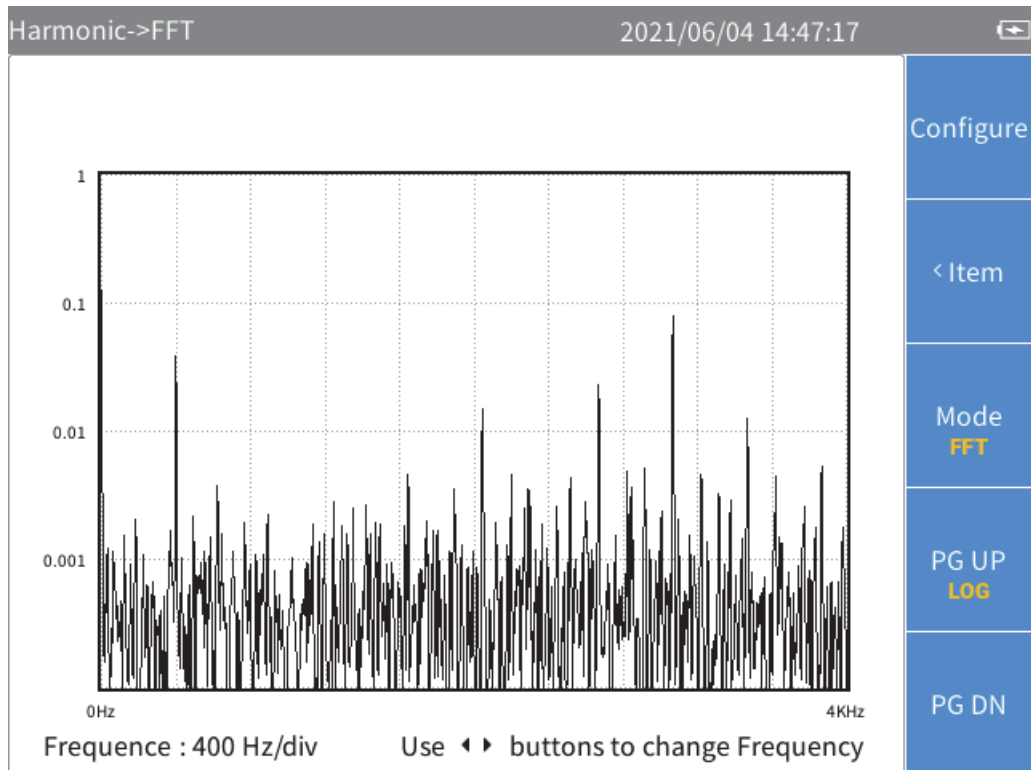

Figure 17. Harmonic FFT

Linear and Logarithmic Axis

In the harmonic bar and FFT view, use **F4** (**AXIS**) button to switch the vertical axis to linear (**LIN**) or logarithmic axis (**LOG**).

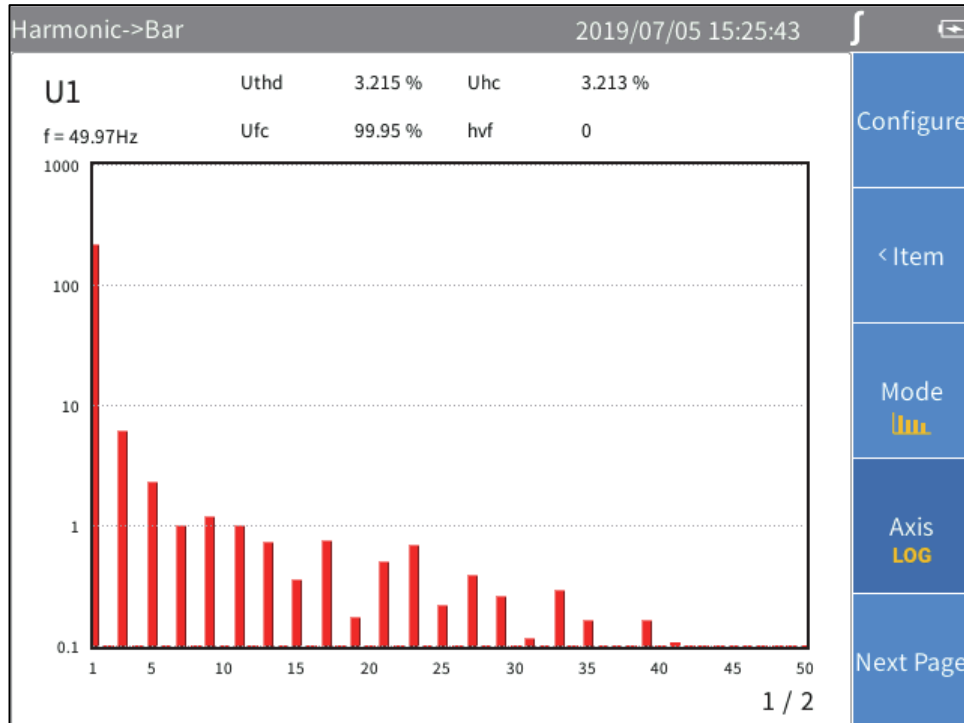

Figure 18. Harmonic - Logarithmic Axis

Phasor

The Phasor mode displays the magnitude and phase relationship of the voltage and current of each phase in the selected wiring group in tabular and graphical form.

Enter Phasor Mode:

- From the Current measurement screen push **PHASOR**.

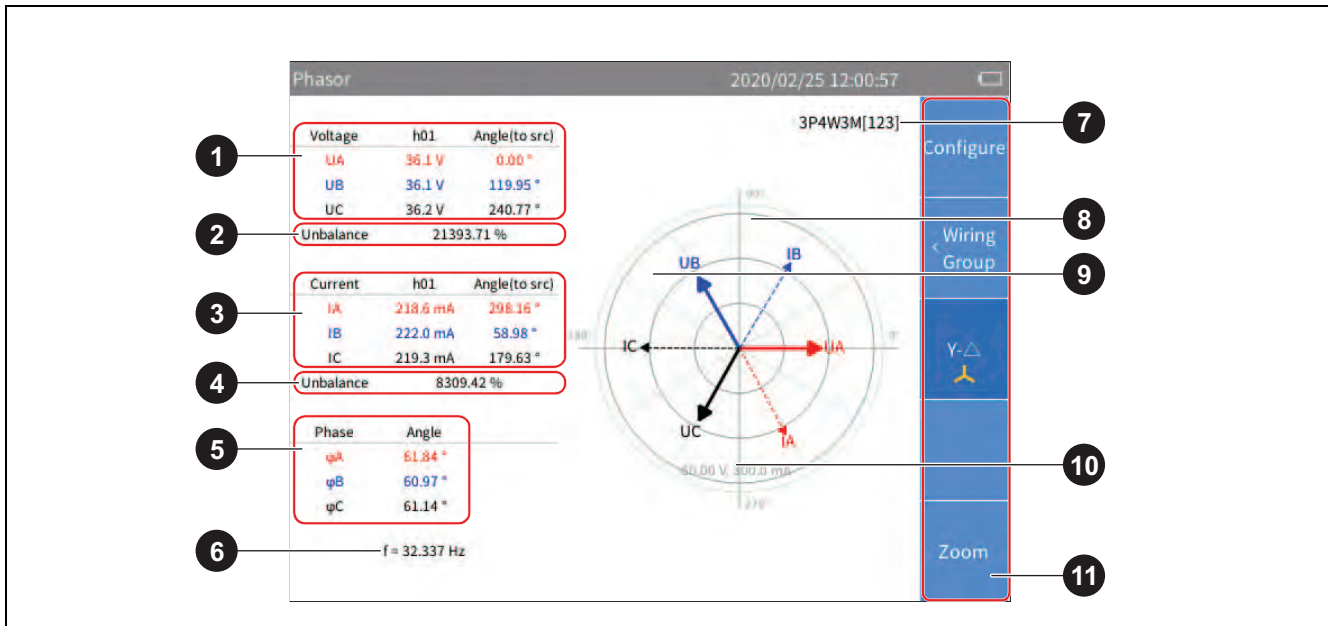

The phasor screen shown in [Table 17](#) is divided into left and right parts, the left part is a phasor table, and the right part is a phasor graph. The content displayed in the table on the left will be displayed synchronously in the graph on the right.

Table 17. Phasor Screen



Item	Description
Table	
1	<p>Voltage phasor information</p> <p>The voltage phasor information of each phase or line in the selected wiring group, including fundamental amplitude and phase angle relative to sync source.</p> <p>See Set the Wiring Selection for information on wiring group.</p>
2	<p>Voltage unbalance</p> <p>The 3-phase voltage unbalance of the currently selected wiring group.</p>
3	<p>Current phasor information</p> <p>The current phasor information of each phase in the selected wiring group, including fundamental amplitude and phase angle relative to sync source. See Select the Phasor Data to Display for details. See Set the Wiring Selection for information on wiring group.</p>

Table 18. Phasor Screen (cont.)

Phasor diagram	
4	<p>Current unbalance</p> <p>The 3-phase current unbalance of the currently selected wiring group.</p>
5	<p>Phase information</p> <p>The relative phase angle between the voltage and current of each phasor in the currently selected wiring group, the unit is degrees (°).</p>
6	<p>Frequency</p> <p>The frequency of the sync source signal in the currently selected wiring group. See Set Sync Source and Update Rate for details.</p>
7	<p>Wiring Selection</p> <p>The wiring selection of the selected wiring group. The current interface data shows the corresponding wiring group, and to switch the wiring group use F2 (Wiring Group).</p>
8	<p>Voltage phasor</p> <p>The voltage phasor of the selected wiring group. The right side of the horizontal axis is the reference and the phase angle of the reference signal is 0°.</p>
9	<p>Current phasor</p> <p>The current phasor of the selected wiring group. The right side of the horizontal axis is the reference and the phase angle of the reference signal is 0°.</p>
10	<p>Voltage and current scale</p> <p>For ease of reading, only the outermost circle scale is marked in the phasor graph.</p>
11	<p>F1 (Configure): Global configuration, see Global Configuration.</p> <p>F2 (Wiring Group): Select a wiring group for measurement, see Set the Wiring Selection.</p> <p>F3 (Y-Δ): Switch the circuit connection (Y/Δ).  represents a star connection.  represents a triangle connection. See Select Circuit Type.</p> <p>F5 (ZOOM): Zoom in/ out phasor, see Zoom Phasor.</p>

Select the Phasor Data to Display

Only phasor data of one wiring group can show on the phasor screen at the same time. The user can select a group from the currently active wiring groups to display its phasor data on the phasor screen.

Enter Wiring Group Menu:

- From the main screen of Phasor, select **F2** (**Wiring Group**).

Select the Phasor Data to Display:

1. In **Wiring Group**, use the left and right arrow (**←** **→**) keys to select a channel or wiring group in **Channel Configuration**. The wiring selection of the selected channel/wiring group is highlighted.

As you move the cursor, you can observe that the data displayed in the **Phasor** screen is updated instantly according to the current options.

2. Push **BACK** to go back to the main screen of Phasor.

Note

The wiring group currently available for display depends on the wiring selection. See [Set the Wiring Selection](#) for details.

Select Circuit Type

From the main screen of Phasor:

1. Select **F3** (**Y-Δ**).
2. Push **F3** (**Y-Δ**) to switch between the star (Y) and the delta (Δ) connection. The current connection type is displayed on the tab page.

Note

The Y-Δ option is only valid when a 3-phase wiring group is selected. When Y is selected, the phasor table displays the voltage of each phase, and the phasor diagram is plotted in the form of Y. When Δ is selected, the phasor table displays the voltage of each line, and the phasor diagram is plotted in the form of Δ.

Zoom Phasor

In the Phasor screen, the Analyzer automatically determines the magnitude of each phasor in the phasor diagram based on the current measurements. However, the user can also manually zoom the phasor diagram of the voltage and current for ease of viewing.

Enter the Zoom Menu:

1. From the main screen of Phasor select **F5** (**Zoom**).

The options are as shown in [Table 18](#).







2. Push **F1** (**ZOOM**) to display  or  below its label as needed.
3. Push **F3** () or **F4** () to zoom in or out the currently selected phasor.
4. To restore to default Auto Zoom, push **F5** (**Auto**).
5. Push **BACK** to go back to the main screen of Phasor.

Table 18. Zoom In/Out Vector

Item		Description
<p>F1</p>	<p>ZOOM U/I</p>	<p>Select the Phasor to Zoom</p> <p>Push F1 (ZOOM) to cycle through the currently selected phasor, namely U or I.</p> <p>The currently selected phasor shows under the “ZOOM” softkey, such as , which means the currently selected phasor is voltage.</p>
<p>F3 F4</p>		<p>Zoom in/out phasor</p> <p>Each time you push F3 (zoom in) or F4 (zoom out), the currently selected phasor is zoomed in or out by a certain step.</p> <p>The steps to zoom in/out the coefficient are: 1, 2, 5, 10.</p>
<p>F5</p>	<p>Auto</p>	<p>Auto zoom</p> <p>Push F5 to enter AUTO mode, and the system automatically determines the most appropriate display scale. All manual zooming settings are ignored.</p> <p>Auto zoom features:</p> <ul style="list-style-type: none"> • The largest phasor does not exceed the outermost circle in polar coordinates • Clearly display each phasor direction point in polar coordinates • Clearly display the name of each phasor

Scope

Use Scope mode to view the waveform of the signal under measurement. The supported signals include voltage and current for example. Up to 4 signals can be selected simultaneously for waveform display.

In addition, the Product provides cursor measurement function that can be used for various measurements or calculations of waveforms. See [Measure with The Cursor](#) for details.

Enter Scope Mode:

- From the Current measurement screen, push **SCOPE**.

The Scope screen is shown in [Table 19](#).

Table 19. Scope Screen

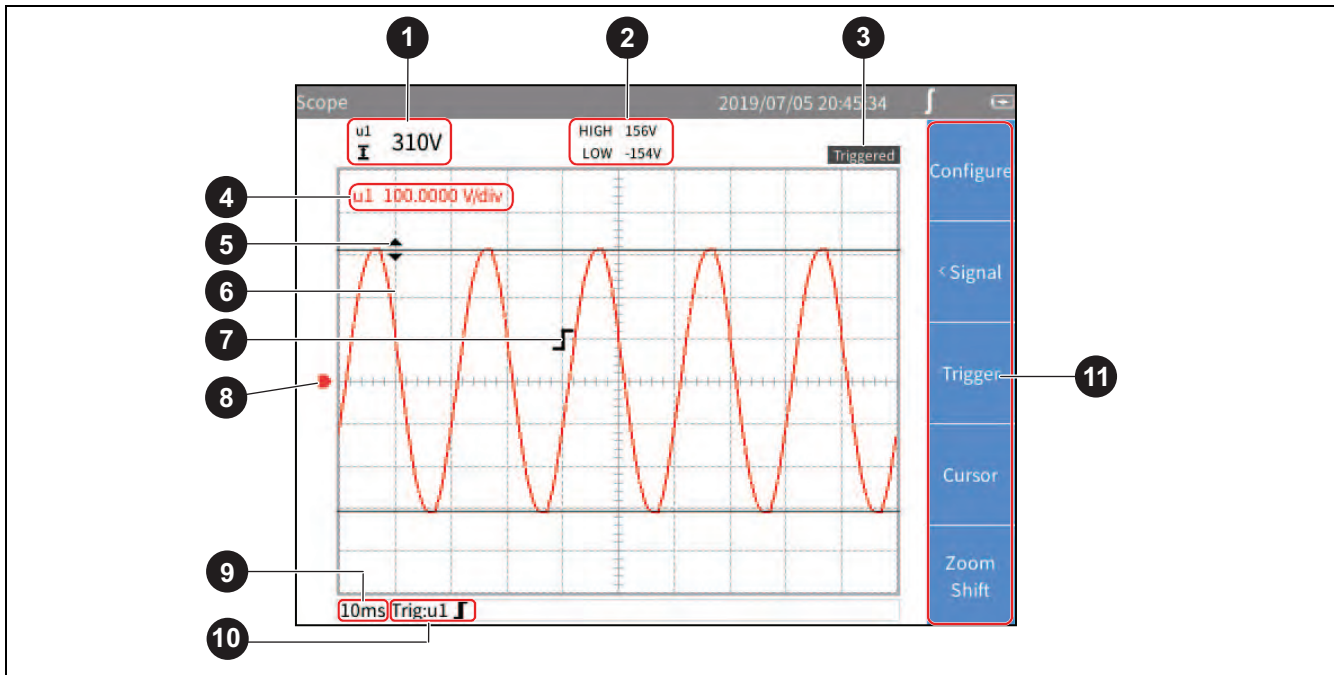

Item		Description
1	Difference between cursors / average at cursor	<ul style="list-style-type: none"> The difference between the 2 cursors is displayed when the double horizontal cursors are activated. The average value of the cursor position is displayed when the single vertical line cursor is activated. The difference between the 2 cross points of the 2 cursors and waveform is displayed when the double vertical cursors are activated. If the cursor is off, no values are displayed in this area. <p>See Measure with The Cursor for details.</p>
2	Value at cursor /time difference	<ul style="list-style-type: none"> The values of the 2 cursors show separately when the double horizontal cursors are activated. HIGH: Value of the upper cursor. LOW: Value of the lower cursor. The maximum and minimum values of the cursors show when the single vertical cursor is activated. MAX: Maximum value. MIN: Minimum value. The time difference (t) between 2 cursors and the frequency value (1/t) calculated accordingly are shown when the double vertical cursors are activated. If the cursor is off, no values are shown in this area.

Table 20 Scope Screen (cont.)

Item		Description
3	Trigger Status	Displays the current trigger status. See Trigger Setup for details.
4	Vertical Axis Scale	Displays the vertical axis scale of each waveform on the current screen, which is the value represented by each grid. The left side is the parameter symbol, and the right side is the vertical axis scale of the parameter. The specific unit depends on the corresponding waveform. The color of the scale depends on the color of the corresponding waveform.
5	Cursor	Cursor mode includes single vertical line, double vertical lines and double horizontal lines. See Measure with The Cursor for details.
6	Waveform	Up to 4 user-selectable waveforms can be shown simultaneously on the screen. See Select the Waveform to Display for details.
7	Trigger Identifier	Indicates the trigger position and level. The shape of the trigger identifier depends on the current trigger mode. See Trigger Setup for details.
8	Ground Level	Represents the ground potential.
9	Horizontal Axis Scale	Horizontal axis (the time axis) scale, the length of time represented by each grid. Horizontal axis supports manual zoom. See Zoom and Shift the Waveform for details.
10	Trigger Source and Trigger Mode	Current trigger setting, showing the current trigger source and trigger mode. See Trigger Setup for details.
11	Soft Keys	F1 (Configure): Global configuration, see Global Configuration . F2 (Signal): Select the waveform displayed on the screen, see Select the Waveform to Display . F3 (Trigger): Trigger settings, see Trigger Setup . F4 (Cursor): Turn cursor on/off and set cursor mode, see Measure with The Cursor . F5 (Zoom/Shift): Zoom and shift waveform, see Zoom and Shift the Waveform .

Select the Waveform to Display

Up to 4 waveforms can be displayed simultaneously on the screen, and the user can select 1 to 4 items from all available items for display.

Enter the Signal Menu:

- From the main screen of Scope select **F2** (**Signal**).

The **Signal** menu lists all currently available parameters, including voltage and current for example. The specific parameters depend on the current system configuration. See [Set the Wiring Selection](#).

Select the Waveform to Display:

- In the **Signal** menu, select up to 4 parameters:
 - Use the arrow (**←** **→** **↓** **↑**) keys to move the cursor over the corresponding item.
 - Push **SELECT**, the selection box of the current item turns yellow and a black “x” symbol is appears, indicating the selection. To remove a selection, push **SELECT** again, the selection box will be cleared.

When a parameter is selected or cleared, the state is reflected in the waveform screen.

- Push **BACK** to go back to the main screen of Scope.

Note

*If 4 signals are selected, all other signals are grayed out. When you push the arrow (**←** **→** **↓** **↑**) keys, the cursor can only move among the selected 4 signals. To select a different signal, you must clear 1 of the 4 signals and then add a new one.*

Trigger Setup

Use Trigger to determine when the Analyzer should start displaying waveforms on the screen so that the waveforms displayed by each refresh can be aligned. Once the set trigger condition is met, the screen is triggered, the waveform displayed on the screen is aligned at that point.

The Analyzer offers a variety of trigger methods to support multiple trigger sources and trigger modes.

Enter the Trigger Setup Menu:







- From the main screen of Scope select, **F3** (**Trigger**).

The options are as shown in [Table 20](#).

Table 20. Trigger Setup

Item		Description
F1	Source	<p>Push F1 (Source) to cycle through the current trigger sources.</p> <p>The currently selected trigger source is shown under the “Source” label with a color block of the same color as the waveform.</p> <p>The selectable trigger sources are the selected signal in the “Signal” menu, which is the signal displayed on the “Vertical Axis Scale” of the screen, see Select the Waveform to Display.</p>











Table 20. Trigger Setup (cont.)

Item		Description
F2	Trigger Option	<p>Configure trigger mode and trigger edge.</p> <ul style="list-style-type: none"> Method: options are Auto, Normal and Single Shot. The default is Auto mode. Slope: options are  Positive,  Negative and  Dual. The default is  Positive.
F4 F5	 	<p>Trigger Level</p> <p>The up and down arrow keys increase or decrease the trigger level. Each time the key is pushed, the trigger mark on the screen moves in the up/down direction.</p>

Note

If the trigger level is not set properly, under the “Auto” mode, the starting point of the waveform displayed (signal level at the left side of the screen) may be unstable, it will jitter left and right. The waveform may not be displayed at all under “Normal” mode.

Trigger Setup:

1. From the main screen of Scope select **F3** (**Trigger**).
2. Push **F1** (**Source**) until the block with the same color as the waveform of the trigger signal is shown.
3. Push **F2** (**Method**).
4. Use the up and down arrow ( ) keys to move the cursor to **Type** and push **SELECT**.
5. Use the up and down arrow ( ) keys to select the appropriate option and push **SELECT**.
6. Use the up and down arrow ( ) keys to move the cursor to **Slope** and push **SELECT**.
7. Use the up and down arrow ( ) keys to select the appropriate option and push **SELECT**.
8. Push **BACK**.
9. Use **F4** (Level ) and **F5** (Level ) to adjust the trigger level as needed.

Measure with The Cursor







Use the cursor to measure the waveform digitally.

Enter the Cursor Setup Menu:

- From the main screen of Scope select **F4** (**Cursor**).

The options are as shown in [Table 21](#).



Table 21. Cursor Setup

Item		Description
F1	Select	<p>Select the measured signal</p> <p>Push F1 (Select) to cycle through the current measured signal.</p> <p>The currently selected signal is shown under the Select label with a color block of the same color as the signal waveform.</p> <p>The selectable signals are the selected signal in the Select menu, which is the signal shown on the Vertical Axis Scale of the screen, see Select the Waveform to Display.</p>
F2	Type	<p>Measurement type</p> <p>Push F2 to cycle through and select the cursor measurement types. Cursor Measurement types include single vertical line, double vertical lines and double horizontal lines.</p> <ul style="list-style-type: none">  (single vertical line)  (double vertical lines)  (double horizontal lines)
F3	Move	<p>Move the cursor</p> <p>Each time you push F3, the currently selected cursor will be cycled through. The selected cursor is indicated in yellow and is displayed below the Move label.</p> <p>After selecting a cursor, use the arrow (   ) keys to move the cursor to the corresponding position on the waveform.</p>
F4	Cursor	<p>Turn the cursor on/off</p> <p>Push F4 to turn the cursor function on or off.</p>

Use the Cursor

The following content uses the double vertical lines as an example to introduce the use of the cursor, which is similar to the use of the cursor of a single vertical lines and double horizontal lines.

- From the main screen of Scope select **F4** (**Cursor**).
- Push **F4** (**Cursor**) until "ON" is shows on the label.
- Push **F2** (**Type**) until  shows on the label.

4. Push **F1** (**Select**) to select the signal to be measured.
The difference between the crossing points of the two cursors and the signal under measurement is shown in the upper left corner of the screen, such as “204.7 V”. The time difference (426 ms) between the two cursors and the frequency (2.347 Hz) calculated are displayed in the upper part of the screen.
5. Push **F3** (**Move**) until  shows on the label, indicating that the left cursor is selected and a diamond mark is displayed on the left cursor.
6. Use the left and right arrow (**←** **→**) keys to move the left cursor to the appropriate position.
7. Push **F3** (**Move**) until  shows on the label, indicating that the right cursor is selected and a diamond mark is displayed on the right cursor.
8. Use the left and right arrow (**←** **→**) keys to move the right cursor to the appropriate position.
9. Read the difference, time difference and frequency value at the top of the screen.

Zoom and Shift the Waveform

The Scope supports horizontal and vertical zooming and shifting. You can select a single waveform independently for vertical zooming and shifting and the waveforms are not affected by each other.

Enter the Zoom Menu:

- From the main screen of Scope select **F5** (**Zoom/Shift**).

The options are as shown in [Table 22](#).

Table 22. Zoom In/Out the Waveform







Item		Description
F1	Select	<p>Push F1 (Select) to cycle through the current selected signal.</p> <p>The currently selected signal is displayed under the “Select” label with a color block of the same color as the signal waveform.</p> <p>The selectable signals are the selected signal in the “Select” menu, which is the signal displayed on the “Vertical Axis Scale” of the screen, see Select the Waveform to Display.</p>
F2	DIR	<p>Zoom direction</p> <p>Push F2 to cycle through and select the zoom direction. Horizontal and vertical zooming of waveforms are supported. The currently selected zoom direction is displayed below the “DIR” softkey label, indicated by a horizontal or vertical two-way arrow.</p> <ul style="list-style-type: none"> •  (horizontal): Zooms the time axis of all signal waveforms in step of 1, 2, 5 and 10. •  (Vertical): Zooms the currently selected signal vertically.

Table 22. Zoom In/Out the Waveform (cont.)

Item		Description
F3 F4		Zoom in/out waveform Each time you push F3 (zoom in) or F4 (zoom out), the waveform is zoomed in or out in a certain step in the horizontal or vertical direction. (Vertical zooming will be applied to the selected waveform. Horizontal zooming will be applied to all waveforms currently displayed.)
F5	Auto	Auto zoom Push F5 to enter the Auto Zoom mode, the system automatically zooms all displayed waveforms to the appropriate scale. All manual zooming settings are ignored.
		Shift waveform In the menu, use the up and down arrow ( ) keys to move the currently selected waveform up and down on the screen.

Trend

The Trend mode displays and records the trend of numerical measurements. Any numerical measurement item can be displayed as a trend, up to 4 trend curves can be displayed simultaneously on the screen.

When the trend function is activated, the Analyzer continuously records the digital reading of the measurements and displays it as a graph. Like a paper chart recorder, the trend graph can be scrolled from right to left.

The bottom of the screen shows the recording time since it starts.

Enter Trend Mode:

- From the Current measurement screen, push **TREND**.

The Trend screen is as shown in [Table 23](#).

Table 23. Trend Screen

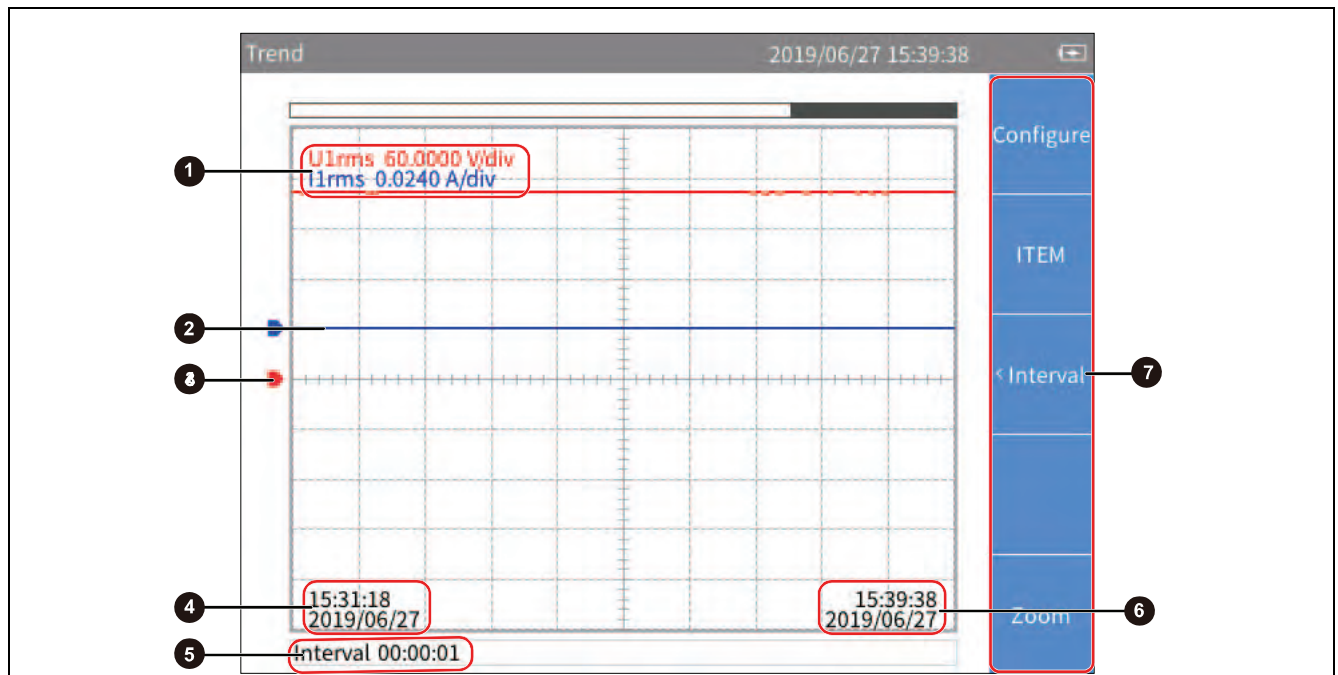

Item	Description
1	<p>Vertical Axis Scale</p> <p>Displays the vertical axis scale of each trend waveform on the current screen, which is the value represented by each grid.</p> <p>The left side is the item symbol, and the right side is the vertical axis scale of its trend curve. The specific unit depends on the corresponding item.</p> <p>The color of the scale depends on the color of the corresponding trend curve.</p>
2	<p>Trend Curve</p> <p>Up to 4 user-selectable trend curves can be displayed simultaneously on the screen. See Select the Trend to Display for details.</p>
3	<p>Zero Position</p> <p>Indicates the zero position of the trend curve.</p>
4	<p>Time on the Left of the Screen</p> <p>Start time of the trend graph on current screen.</p>
5	<p>Interval</p> <p>Sampling interval used to draw the current trends.</p>
6	<p>Current Time</p> <p>End time of the trend graph on current screen.</p>
7	<p>Soft Keys</p> <p>F1 (Configure): Global configuration, see Global Configuration.</p> <p>F2 (Item): Select trend items displayed on the screen, see Select the Trend to Display.</p> <p>F3 (Interval): Set the acquisition interval of the trend curve. See Set Measurement Period.</p> <p>F5 (Zoom/Shift): Zoom / shift trends, see Zoom and Shift the Trend.</p>

Select the Trend to Display

You can select 1 to 4 items from all available items to show on the screen.

Enter the Item menu:

- From the main screen of Trend select **F2** (Item).

The Item menu is as shown in Table 24.

Table 24. Select the Trend to Display

Item		Description
F1	Display	Set the trend curve currently displayed. You can choose from up to 4 trend curves. All 4 trend curves are displayed by default.
F2	Add	Add items to plot trend curves and up to 4 collection items can be added.
F3	Del	Delete the trend item that is currently added.

Display/hide Trend Curve:

- From the main screen of Trend select **F2** (Item) > **F1** (Display).
- In **Display** dialog, use the up and down arrow (⏴ ⏵) buttons to move the cursor over the trend curve you want to display/hide.
- Push **SELECT** to select or deselect the current item depending on its previous state.

When a trend curve is selected or deselected, it will immediately be reflected in the trend screen to display or hide the trend curve.

- Push **BACK** to go back to the main screen of Trend.

Note

The Display menu is equivalent to a buffer that can hold up to 4 items. Use **F2** (Add) and **F3** (Del) to add the 4 most commonly used items to the buffer. Then select the trend data to show/hide the trend curve through the Display menu. This avoids frequently using the cumbersome **F2** (Add) and **F3** (Del) keys to switch the displayed trend curve.

Add Trend Item:

- From the main screen of Trend select **F2** (ITEM) > **F2** (Add).

The Add menu is shown. All available items are listed by categories in a tree structure. The available trend items contain the most measurement items under Meter function.

- Use **F1** to **F4** button to enter the category.
- For each item to add (up to 4):
 - Use the navigation arrow (⏴ ⏵) keys to move the cursor over the corresponding item.

In most cases, there are 2 dialog boxes displayed in the measurement tree menu, the one on the left lists the names of items, and the one on the right lists the supported channels or wiring groups. The yellow block represents the cursor position, and the yellow box indicates the corresponding branch in the current tree structure.

- Push **SELECT** to enter its sub-menu (if any).
- Use the arrow (⏴ ⏵) keys to move the cursor over the corresponding item.

d. Push **SELECT** to add the current item. The item will be highlighted in yellow.

After the item is added successful, you will be straight back to the top-level parameter menu.

4. Push **BACK** repeatedly to go back to the main screen of Trend.

Note

If there are already 4 trend items in the “Display” menu, you cannot add a 5th item regardless of whether they are all displayed on the trend screen. You must delete one or more trend items and then add other items.

Delete Trend Item:

1. From the main screen of Trend select **F2** (ITEM) > **F3** (Del).
2. In “Del” dialog, use the up and down arrow (⏪ ⏩) buttons to move the cursor over the item to be delete.
3. Push **SELECT** to delete the current item from the Display menu.
4. Go back directly to ITEM screen.

Note

When deleting trend data, remove an item from the Display menu by using the Del menu even if its trend curve is not displayed on the screen.

Set Measurement Period

The measurement period is the time interval used to plot the trends and provides two modes of **Update Rate** and **Interval**. In the **Update Rate** mode, the interval of the trends is the update rate of the Analyzer, which can achieve accurate evenly spaced acquisition, which is suitable for analyzing the process of rapid change. In the **Interval** mode, the interval of the trends is determined by the trend function itself, which is not as accurate as the Update Rate mode, but it can record the trends for a long time.

Enter the Measurement Period Setup Menu:

- From the main screen of Trend select **F3** (Interval).

The measurement period setup dialog is shown in [Table 25](#).

Table 25. Measurement Period Setup

Item	Description
Update rate	By update rate The measurement period is the same as the update rate of the Analyzer by default. The update rate is a kind of global configuration of the Analyzer. See Set Sync Source and Update Rate for information on update rate.

Table 25. Measurement Period Setup (cont.)

Item	Description
Interval	Customize sampling interval You can customize sampling interval as measurement period. The minimum interval is 1 second and the maximum is 24 hours <ul style="list-style-type: none"> • H: Customize the Hour value of the interval. • M: Customize the Minute value of the interval. • S: Customize the Second value of the interval.

Customize the Interval

1. From the main screen of Trend select **F3** (**Interval**).
2. If **Update Rate** is selected, use the up and down arrow (⬆️ ⬇️) keys to move the cursor to **Interval**. Push **SELECT**. The **Interval** option is selected.
3. Use the up and down arrow (⬆️ ⬇️) keys to move the cursor to **H** (Hour) input box.
4. Use the left and right arrow (⬅️ ➡️) keys to adjust the Hour value.
5. Push **SELECT**.
6. Use the left and right arrow (⬅️ ➡️) keys and **SELECT** to set Minutes and Seconds.
7. Push **BACK** to go back to the main screen of Trend.

Zoom and Shift the Trend

The Trend supports vertical and horizontal shifting as well as vertical zooming. Each trend graph can be shifted and zoomed vertically independently, and they are not affected by each other.

Enter the Zoom Menu:

- From the main screen of Trend select **F5** (**Zoom/Shift**).
The options are as shown in [Table 26](#).

Table 26. Zoom the Trend



Item		Description
F1	Select	Select the trend Push F1 (Select) to cycle through the currently selected trend. The currently selected trend is displayed under Select with a color block of the same color as the trend curve. The available trend is the selected items in the ITEM menu, which is the items displayed on the Vertical Axis Scale of the screen, see Select the Trend to Display .
F3 F4		Zoom in/out waveform Each time you push F3 (zoom in) or F4 (zoom out) button, the selected waveform will be zoomed in or out vertically by a certain step.

Table 26. Zoom the Trend (cont.)

Item		Description
F5	Restore	Restore auto zoom When this button is pushed, it will restore to the display scale automatically determined by the system.
		Shift waveform In the interface of this menu, use the navigation arrow () keys to shift the currently selected trend up and down on the screen, and the left and right movement will be applied to all displayed trends.

Data Management

The Analyzer can save the measurement data and the current configuration of the Analyzer in the internal memory, or log the data displayed on the current screen in Meter mode for a long time. The data can be downloaded to a PC by using the Fluke Power Analyzer software. For more information, please refer to the instructions for using the PC software.

Use **MEMORY** to manage the data stored in the internal memory.

Save Data

On any measurement screen, push **SAVE** and the Save dialog box will show on the screen.

- Push **F1** (**Data**) to save all valid measurements at the current time to the internal memory. When it is saved successfully, a prompt message containing the name of the file will show on the screen.
- Push **F2** (**Settings**) to save the current system settings and the configuration of all measurement functions. When the save is successful, a message containing the name of the file shows on the screen.

Note

*The Analyzer automatically creates the file name based on the category of the saved data and system time. To modify the file name, after it is saved, push **MEMORY** and follow the prompt. (See [Memory](#))*

Logger

Enter the Logger Menu:

- In Meter mode, push and hold **SAVE** for more than 2 seconds, to show the Logger menu on the screen.

The functions in the Logger menu are as shown in [Table 27](#).

Table 27. Logger

Item		Description
F1	Manual Logger	<p>Push F1 (Manual Logger) to manually start the logger. The Analyzer will log all measurements currently shown on the screen.</p> <p>Push F1 (Stop Logger) to stop logging, and the screen will prompt you that a log file was created successfully, including the name of the log file.</p> <p>The symbol LOG appears on the title bar to indicate that Logger is in progress.</p>
F2	Auto Logger	<p>Push F2 (Auto Logger) to enter Auto Logger menu, in this mode, the logger can be stopped either manually or automatically.</p> <ul style="list-style-type: none"> Manual stop: Only the start time is specified. After Logger starts, it needs to be stopped manually. Automatic stop: The start time and duration of the Logger are specified. When the duration time finished, the Logger will automatically stop. <p>If the specified start time is a future time, Logger will enter Logger waiting status after pushing F1 (Confirm). The symbol LOG appears on the title bar to indicate that Logger is waiting to start.</p> <p>For detailed information, see Auto Logger</p>
F3	Logger Interval	<p>Push F3 (Logger Interval) to enter Logger Interval menu and set the Logging period. For detailed information, see Logger Interval</p>

Auto Logger

The Analyzer provides automatic logger mode.

1. Use the up and down arrows (▲ ▼) to select the appropriate option and push **SELECT**.
2. Use the left and right arrow (← →) keys to adjust the time and duration as needed.
3. Push **F1** (**Confirm**) to start logger.
4. Push **F2** (**Cancel**) to go back to the main screen of Logger menu.

Logger Interval

The logger interval can be set to **Update Rate** or specified **Interval**.

- When set to **Update Rate**, the logger interval is the update rate of the Analyzer, which can achieve accurate equidistant acquisition, which is suitable for analyzing the process of rapid change.
- When set to specified **Interval**, the logger interval can be customized for long-time logging, however not as accurate as the Update Rate.

The logger interval interface is shown in [Table 28](#).

Update Rate is selected by default.

1. Use the up and down arrow (▲ ▼) keys to move the cursor to **Interval**. Push **SELECT**, the Interval option is selected.
2. Use the up and down arrow (▲ ▼) keys to move the cursor to **H** (Hour) input box.
3. Use the left and right arrow (◀ ▶) keys to adjust the Hour value.
4. Continue using the arrow keys to adjust the Minute and Second value.
5. Push **F1** (**Confirm**) to take the adjustment into effect and back to main screen of Logger menu.
6. Push **F2** (**Cancel**) to go back to the main screen of Logger menu without any change.

Table 28. Logger Interval

Item	Description
Update rate	<p>By update rate (default)</p> <p>The logger interval is the update rate of the Analyzer.</p> <p>The update rate is a kind of global configuration of the Analyzer. See Set SyncSet Sync Source and Update Rate for information on update rate.</p>
Interval	<p>Customize acquisition interval</p> <p>Acquisition interval can be customized, the minimum interval is 1 second and the maximum is 24 hours</p> <ul style="list-style-type: none"> - H: Customize the Hour value of the interval. - M: Customize the Minute value of the interval. - S: Customize the Second value of the interval.

Note

During logging, the user cannot switch screens and perform other measurement functions. If the user tries to perform other operations, the Analyzer will prompt you to stop the logger.

*The logger function is available in the Meter mode only. In other modes, when you push and hold **SAVE**, the Analyzer will show a message that indicates the Logger is only available in Meter mode.*

*Even in Meter mode, the logger function is not supported if the user freezes the display with **HOLD**. You must exit the Hold mode first before you can use the Logger function.*

Memory

1. Push **MEMORY** to enter the **Memory** interface.
The available file types are shown in [Table 29](#).

2. Select the type of file.







Table 29. Memory Data Management

Item		Description
F1	Data	View and manage saved data files.
F2	Logger Sessions	View and manage Logger items.
F3	Screen Captures	View and manage saved screenshot files.
F4	Settings	View and manage saved settings files.

The available file actions are shown in [Table 30](#)

3. Select the action. To delete one file, rename, or playback, select the file and then select the action.

Table 30. Memory File Operation

Item		Description
F1	Del	Delete a file
F2	Del All	Delete all files of the current type.
F3	Rename	The Analyzer uses an automatic naming method when saving files. With this function key, the user can rename each file to a name that is easy to remember.
F4		Page up key When the number of files available exceeds the number of items displayed on each screen, the  and  keys can be used to scroll forward or backward to display more files.
F5		Page down key Page down key for scrolling backward to display next page.
		Playback Use the navigation arrow () keys to playback the selected file.

Note

When you select “Delete”, the Analyzer deletes the selected files or deletes all files of the current category without any prompts. The files deleted by these operations cannot be restored locally. Please operate with caution.

Dual-Unit Interconnection

The Analyzer supports Dual-Unit Interconnection, that is, 2 Analyzers work synchronously in host/slave mode to realize 6-channel or 8-channel configuration.

2 Analyzers are connected in a point-to-point manner by using the RS-485/sync adapter provided with the Analyzer to connect the RS-485 communication ports on the right side of the 2 Analyzers, which are 3-pin connector sockets, as shown in the [Figure 19](#).

For the 2 Analyzers, one works as a host and the other works as a slave.

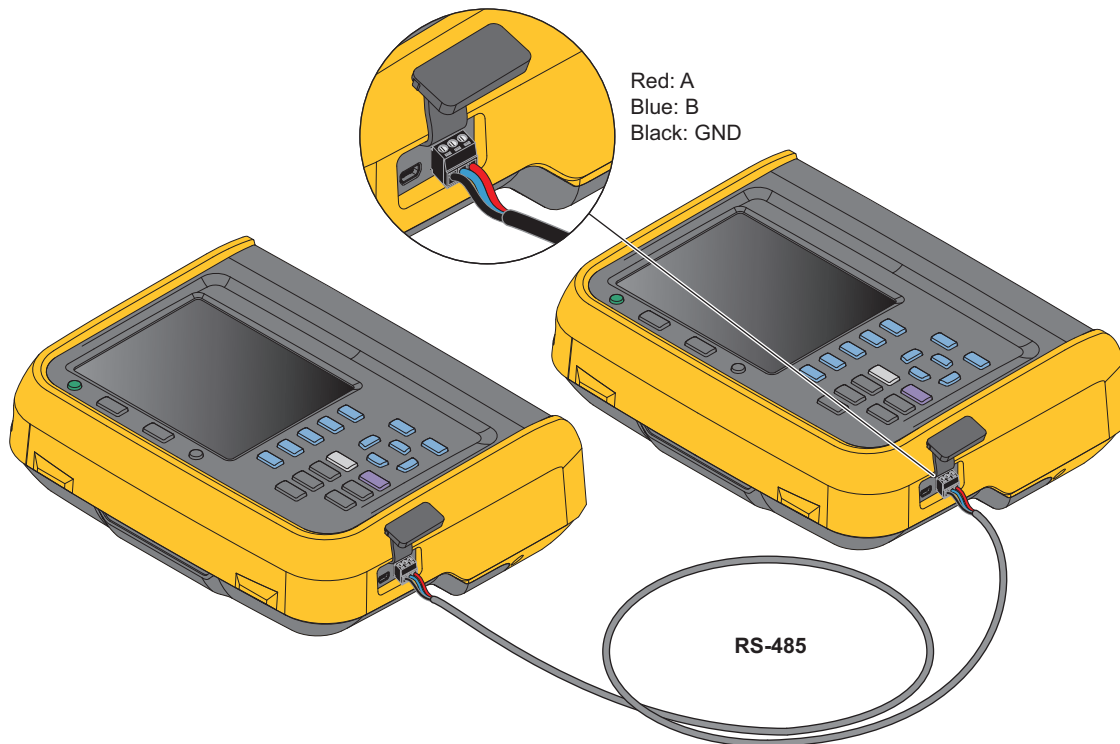

Figure 19. Dual-Unit Interconnection

Note

The host can only add user defined measurement items that have been added in the slave. See [User Item View](#) for more information on user defined measurement items.

Dual-Unit Interconnection Measurement

Dual-Unit Interconnection Measurement require specific RS-485 communications parameters. These are:

- Baud Rate = 921600,
- Parity = None,
- EOL = CRLF,
- Data Bit = 8,
- Stop bits = 1.

After the 2 Analyzers are connected through the RS-485 port, follow these steps to make measurements:

1. Set RS-485 communication parameters of the slave.
 - a. From the main screen in any operating mode of the slave, select **SYSTEM** > **F2** (**Comm.**), and then select the RS-485 connection method. Follow the instructions in [Set Communication Parameters](#).
 - b. Push **BACK** repeatedly to go back to the main screen of the Meter.
2. Set RS-485 communication parameters of the host. On the host:
 - a. Push **SYSTEM** > **F2** (**Comm.**) and then select the RS-485 connection method. Follow the instructions in [Set Communication Parameters](#).
 - b. Push **SYSTEM** > **F3** (**Remote**) to enter the **Remote** menu.

The host's screen prompts that the remote device is being searched, and the host will automatically scan the connected device.

After the Analyzer as a slave is searched by the host the connected device shows in the **Available devices list**, such as **Address 2**.

- c. Push **F1** (**Connect**) to enter the **Remote** menu. If the connection succeeds, the label for **F2** changes to **Disconnected**.
 - d. Push **BACK** repeatedly to go back to the main screen of the System.
 - e. Follow the instructions in section [User Item View](#) to enter the interface of Add Measurement Items. Notice that **F5** (**Remote**) is added to the category of Add measurement items.
 - f. Push **F5** (**Remote**).

All user defined measurement items selected on the slave will be listed on the host's screen.
 - g. Use the arrow (**←** **→** **↑** **↓**) keys to move the cursor to the corresponding measurement item and push **SELECT**.

The corresponding measurement items show in the list of user defined measurement items on the host (the measurement item name has the suffix "***").
3. To exit Dual-Unit interconnection mode:

On the host, push **SYSTEM** > **F3** (**Remote**) > **F2** (**Disconnect**).

Or

On the slave, push **F1** (**Local**).

Note

If the measurement item is not listed in the Remote interface on the host, exit the Dual-Unit interconnection mode and add the measurement items on the slave. See [User Item View](#) for details.

Note

*Under the Dual-Unit interconnection mode, the slave will be locked for remote operation and the buttons on the control panel will be locked (except for **(F1)** (**Local**)) and no other operations can be performed.*

Connect the Computer

The Fluke Power Analyzer software is a software that communicates between the Analyzer and PCs through RS-485 or mini-USB interfaces. With this software, data can be controlled and summarized simply and quickly on the PC.

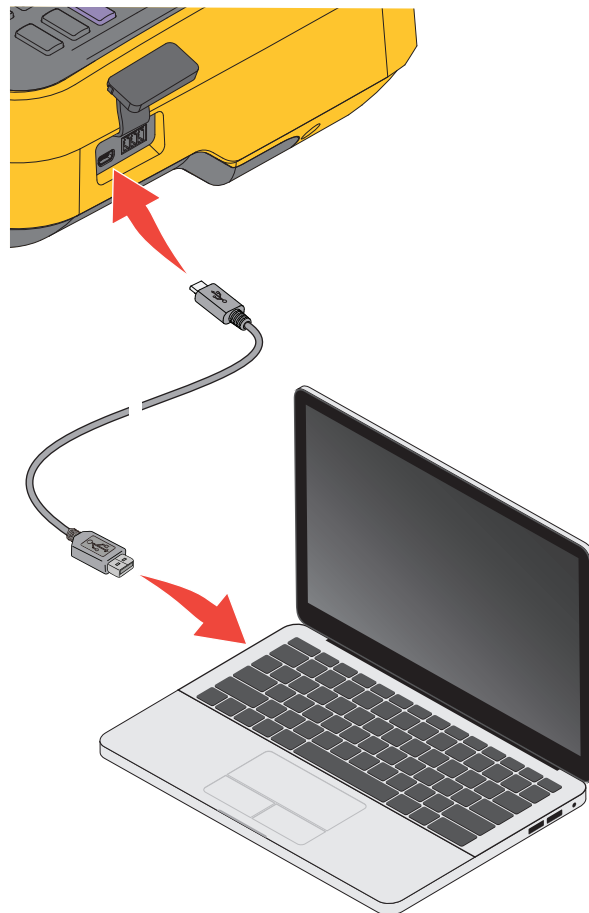

Figure 20. Connect the Computer

With the Fluke Power Analyze software:

- The PC screen shows the measurements, waveforms, phasors, harmonics and trends from the Analyzer Select from all measurements such as voltage, current, power and harmonics.
- Instrument settings: settings of the connected Analyzer can be changed in the PC software.

- Files in the Analyzer memory can be downloaded to a PC and analyzed.
- Operating system required: Windows 10 / Windows 8 / Windows 7 (32bit/64bit).

For more information about using the Analyzer with the PC software, refer to the instructions for using the PC software.

System Settings

The System Settings function provides the system level setup options, including general settings, communication parameter settings, local/remote control, as well as the test of the Analyzer itself.

Enter the System Settings Function:

- From the main screen in any operating mode push **SYSTEM**.

All information listed in the work area of the System screen is reference information and cannot be changed. This information is useful for troubleshooting and maintenance.

Note

Table 31. System Information

Item	Description
Description	Product name, such as Power Analyzer.
Model Name	Product model, for example Norma 6004+
Serial No.	The unique serial number of the product, which may be requested when
Calibration Date	Last calibration date of the Product. See Calibration for information on calibration.
Firmware Version	The version number of the internal firmware of the Product.
DSP Version	The version numbers of the Digital Signal Processing (DSP) device in the Product.
FPGA Version	The version number of the FPGA in the Product.
Soft Keys	<p>F1 (Settings): Sets general options for the Analyzer, see <i>General Settings</i>.</p> <p>F2 (Comm.): Sets the serial communication parameters of the Analyzer, see Set Communication Parameters.</p> <p>F3 (Remote): Connects remote analyzer, see Remote.</p> <p>F4 (Maint.): Diagnoses and tests the LCD and buttons/keys of the Analyzer, see Instrument Maintenance.</p>

General Settings

The Settings screen contains some general instrument settings such as interface language, time and date, date format, log storage settings, as well as firmware upgrades and factory resets.

Enter the Settings screen:

- From the Main screen in any operating mode select **SYSTEM** > **F1** (**Settings**).

The options listed on the Settings screen include:

- Language
- Time date
- Date format
- Auto-off
- Firmware upgrade
- Factory default
- Memory

See Firmware Upgrade for the operation of firmware upgrade.

Language

Users can select the language supported by this unit.

Change UI Language:

1. In the **Settings** screen, use the up and down arrow (**▼ ▲**) keys to move the cursor to the **Language** option (the drop-down menu is highlighted in yellow).
2. Push **SELECT** and use the up and down arrow (**▼ ▲**) keys to select the corresponding option. Then push **SELECT** again to confirm the option.
3. Push **BACK** repeatedly to go back to the main screen of the **Settings**.

Set Time and Date

In the Settings screen:

1. Use the up and down arrow (**▼ ▲**) keys to move the cursor to the **Date Time** option (the drop-down menu is highlighted in yellow).
2. In the **Time Date** dialog box, use the left and right arrow (**← →**) keys to select the year, month, day, hour and minute, and use the up and down arrow (**▼ ▲**) keys to adjust the value.
3. Push **BACK** repeatedly to go back to the main screen of the **Settings**.

Auto-Off

If set to ON, the power turns off automatically after 30 minutes without operation, communication, integral, or logging.

Default is OFF.

Memory

The user can select the operation mode of the Analyzer when the memory is full, which can be set to stop the logging by the system, to manually clear log files saved in the Product by the user, or to automatically overwrite the old files by the system.

1. In the **Settings** screen, use the up and down arrow (⏮ ⏭) keys to move the cursor to the **Logger Memory** option (the drop-down menu is highlighted in yellow).
2. Push **SELECT** and use the up and down arrow (⏮ ⏭) keys to select the corresponding option. Then push **SELECT** again to confirm the option.
3. Push **BACK** repeatedly to go back to the main screen of the **Settings**.

Set Communication Parameters

The Analyzer supports communication via USB virtual serial port and RS-485. Host/slave communication is realized by RS-485 communication in the dual-unit interconnection mode. For details, see [Dual-Unit Interconnection](#).

In order to ensure normal communication, the communication port of the Product needs to be set up correctly.

Enter the Comm. Setup Interface:

- From the Main screen in any operating mode select **SYSTEM** > **F2** (**Comm.**).

The "Comm." settings screen is shown, the items that can be set for USB virtual serial port and RS-485 port are as shown in [Table 30](#).

Table 32. Communication Parameters

Item	Option
Connect	USB (virtual serial) port RS-485
Parity	O : Odd parity E : Even parity N : No parity
Baud Rate	9600 19200 38400 57600 112500 230400 460800 576000 921600

Table 32. Communication Parameters (cont.)

Item	Option
EOL	CR LF CRLF
Data Bits	7 Bits 8 Bits
Stop Bits	1 Bits 1.5 Bits 2 Bits
Device address	1 to 9

Note

To ensure proper communication between the host/slave Analyzer, you must configure both Analyzers correctly. Please refer to [Dual-Unit Interconnection](#).

Remote

The Analyzer supports Dual-Unit interconnection. This menu allows 2 Analyzers to be configured in host/slave mode for 6 or 8 channels configurations. See [Dual-Unit Interconnection](#) for details.

Instrument Maintenance

The Analyzer provides a self-diagnosis function that allows the user to test the button/key and display screen of the Product.

Enter Diagnosis:

- From the Main screen in any operating mode select **SYSTEM** > **F4** (Maint.)

Table 33. Diagnostics

Item	Description
F1 LCD Test	Push ▼ , the screen will show alternately full-screen of solid colors of blue, black, white, red and green. Push BACK to go back to the test menu.
F2 Keys Test	Test if each key is valid. All the keys on the control panel are shown on the screen. The original function of all the keys on the control panel will be disabled. Each time a physical key on the control panel is pushed, the corresponding key on the screen changes from white to yellow. Pushing BACK will not take you back to the main menu. The screen will automatically go back to the Maint. menu only after all physical buttons/keys on the control panel have been tested.

Calibration

Maintenance

The only required maintenance is to replace the battery regularly and to replace the fuse, if necessary.

Cleaning

Clean the case with a damp cloth and a weak soap solution. Do not use abrasives, isopropyl alcohol, or solvents to clean the case.

Warning

Before cleaning the Analyzer, please be sure to unplug the power adapter/charger from the power jack and disconnect all test leads.

Change the Battery

The battery is charged in the Analyzer, the battery can be changed if a freshly charged battery is required for extended battery power operation or the battery is no longer keeping charge. Charge the Analyzer every three months if the Analyzer is not in use.

Warning

**To prevent electric shock, remove all probes, test leads and accessories before the battery compartment cover is opened.
Do not use any battery which is not designed or recommended by Fluke for use with the Product.**

Caution

Do not incinerate the product and/or the battery.

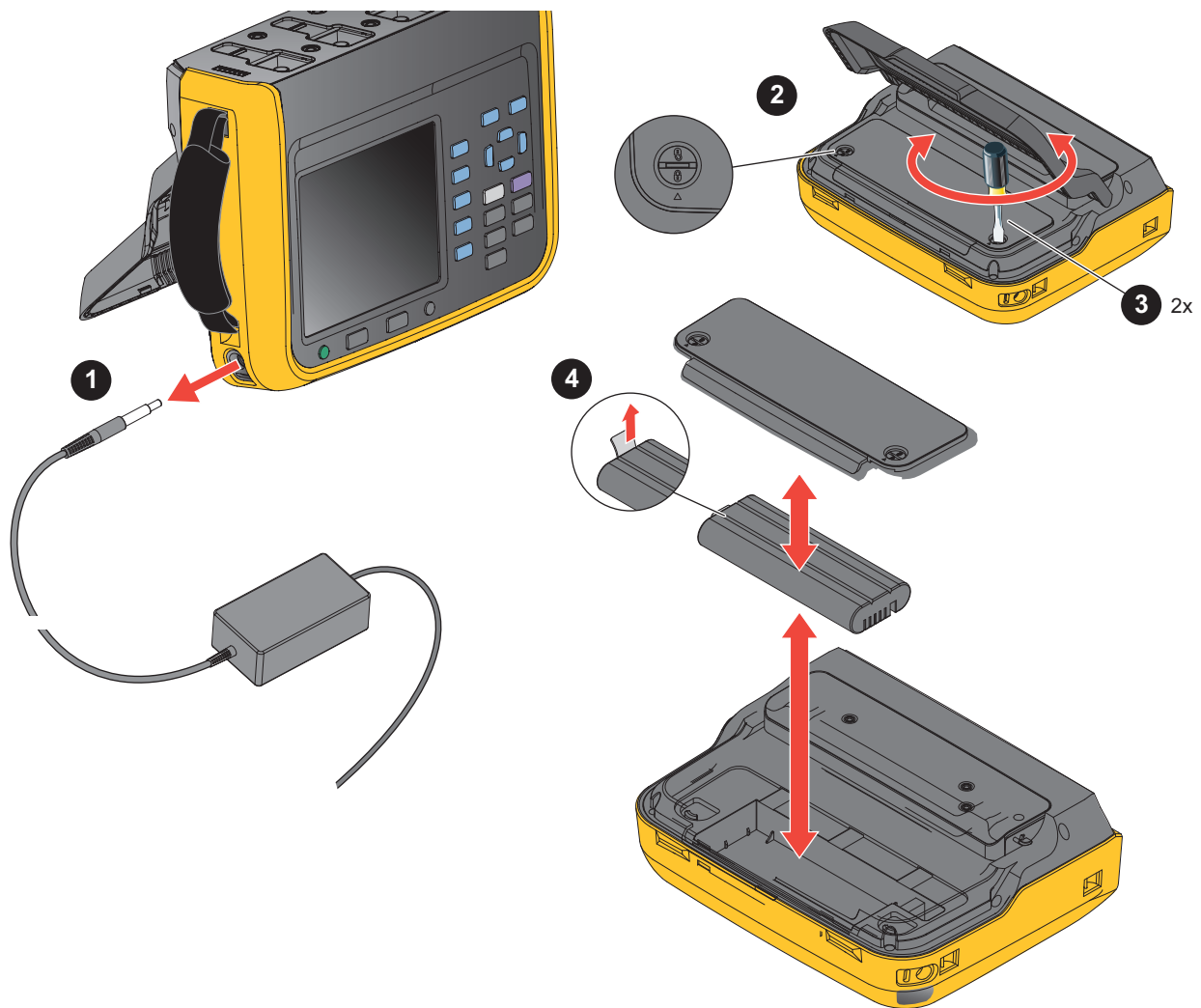

Figure 21. Change the Battery

To Change the Battery:

1. Turn off the Product, unplug the power adapter/charger from the power jack, and disconnect all test leads.
2. Place the Product's operating panel face down on a flat table and lift the stand or remove it from the Product.
3. Use a slotted screwdriver to rotate the 2 snap bolts on the battery compartment cover by 180° so that the arrow on the cover points toward the unlock mark and then remove the battery compartment cover.
4. Use the drawstring on one end of the battery to lift one side of the battery and then remove the battery completely.
5. Install new batteries and reinstall and fix the battery compartment cover and stand in the reverse order of the above.

Change the Fuse

See Figure 22.

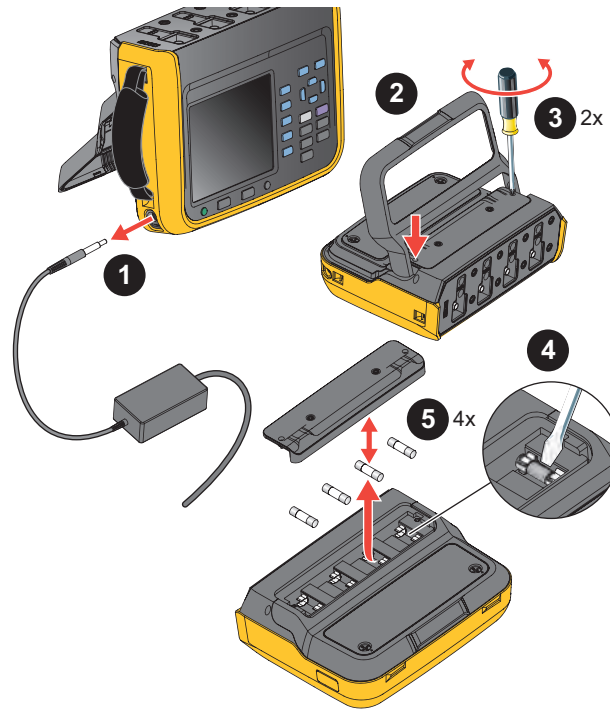

Figure 22. Fuse Replacement

⚠ Caution

To change the fuse:

1. Turn off the Product, unplug the power adapter/charger from the power jack, and disconnect all test leads.
2. Place the operating panel face down on a flat surface and fold the tilt stand or remove it from the Product.
3. Use a Phillips screwdriver to remove the 2 screws from the fuse compartment cover and remove the cover.
4. Insert a flat screwdriver into the gap to the right of the fuse holder and gently pry it until it is possible to hold the fuse by one hand and take it out.
5. Install new fuses and reinstall and fix the fuse cover and stand in the reverse order of the above.
6. Check the circuit before reconnecting to ensure the current does not blow the fuse again.

Firmware Upgrade

The firmware upgrade of the Product is convenient and can be completed by using the USB memory containing the new firmware.

Please refer to [Figure 23](#).

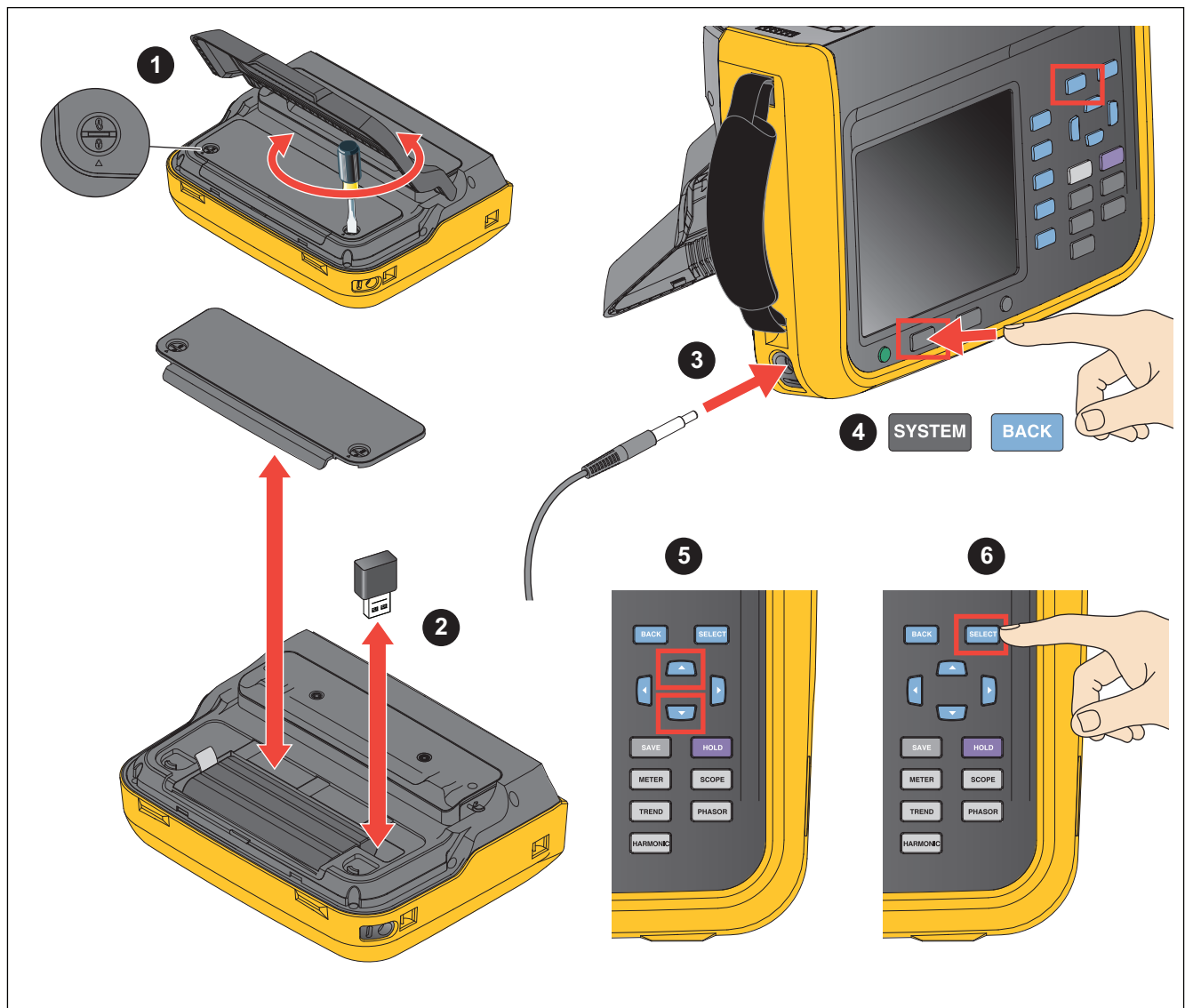

Figure 23. Firmware Upgrade

1. Open the cover of the battery compartment as specified in the section [Change the Battery](#).
2. Plug the USB memory containing the new firmware into the USB port on the upper-right side of the battery compartment.

3. During the upgrade, make sure that the battery is in good contact and can power the unit normally, and the USB connection is reliable.
4. After the instrument is powered on, select **SYSTEM** > **F1** (**Settings**).
5. Use the up and down arrow (⏮ ⏭) keys to move the cursor to **Firmware Upgrade** (the drop-down menu is highlighted in yellow).
6. Push **SELECT**.

Note

If the USB memory is not inserted, the Product will prompt to insert the USB. Follow the steps above to insert the USB memory. Or check if the USB memory is connected securely.

The upgrade will take a few minutes. Wait for the upgrade to complete. The Analyzer automatically restarts after the upgrade.

Note

To ensure the success of the upgrade, the battery must be installed during the firmware upgrade and the battery level must be at least 50 %. The power adapter must be connected.

Specifications

General Specifications

Size (HxWxL).....	298 mm x 215 mm x 96 mm
Weight.....	3.5 kg
Display	5.7" TFT LCD, 640x480 pixels
Maximum voltage between any Terminal and Earth Ground... ..	1000 V
Temperature	
Operating Temperature	0 °C to 40 °C (with power adapter) -10 °C to + 50 °C (battery only)
Storage Temperature.....	-30 °C to 60 °C (Without battery) -20 °C to 60 °C (With battery)
Operating Humidity.....	Non-condensing (<10 °C) ≤90 % RH (10 °C to 30 °C) ≤75 % RH (30 °C to 40 °C) ≤45 % RH (40 °C to 50 °C)
Altitude	
Operating.....	2000 m
Storage	12 000 m
Ingress Protection.....	IEC 60529: IP50 (terminals mated)
Battery	
Type.....	Li-ion, BP 291, 10.8V/5000 mAh, 54 Wh IEC 62133, UN 38.3
Battery life.....	10 hours (Typical)
Safety	
General.....	IEC 61010-1: Pollution Degree 2

Measurement IEC 61010-2-030: CAT IV 600/CAT III 1000 V

Electromagnetic Compatibility (EMC)

International..... IEC 61326-1: Industrial Electromagnetic Environment;
IEC 61326-2-2, CISPR 11: Group 1, Class A

Group 1: Equipment has intentionally generated and/or uses conductively-coupled radio frequency energy that is necessary for the internal function of the equipment itself.

Class A: Equipment is suitable for use in all establishments other than domestic and those directly connected to a low-voltage power supply network that supplies buildings used for domestic purposes. There may be potential difficulties in ensuring electromagnetic compatibility in other environments due to conducted and radiated disturbances.

Caution: This equipment is not intended for use in residential environments and may not provide adequate protection to radio reception in such environments.

Emissions that exceed the levels required by CISPR 11 can occur when the equipment is connected to a test object.

Korea (KCC)..... Class A Equipment
(Industrial Broadcasting & Communication Equipment)

Class A: Equipment meets requirements for industrial electromagnetic wave equipment and the seller or user should take notice of it. This equipment is intended for use in business environments and not to be used in homes.

USA (FCC) 47 CFR 15 subpart B.

This product is considered an exempt device per clause 15.103.

Electrical Specifications

Modules

NORMA 6003 3 Voltage + 3 Current

NORMA6003+ 3 Voltage + 3 Current + 1 Motor

NORMA 6004 4 Voltage + 4 Current

NORMA 6004+ 4 Voltage + 4 Current + 1 Motor

Sample Rate 200 kHz

Data Update Rate 100 ms, 200 ms, 500 ms, 1 s

Voltage

Range 10 V, 100 V, 1000 V

Crest Factor CF ≤2

Overload Capacity..... 10 % overload

Input Impedance 2 MΩ / 10 pF (Typical)

Temperature Coefficient 0.05 x (Spec)/K @ <18°C or >28°C

Bandwidth 1000 V range: 500 kHz
100 V range: 200 kHz
10 V range: 100 kHz

Accuracy

Accuracy (% reading + % range)

Range	DC	AC	
		10 Hz to 1 kHz	10 kHz
1000 V	0.1 + 0.1	0.1 + 0.1	5 + 0.5
100 V	0.1 + 0.1	0.1 + 0.1	5 + 0.5
10 V	0.1+0.2	0.1 + 0.2	5 + 0.5

Frequency Domain Measurement

Frequency Accuracy..... 0.05 % range + 0.05 % reading
(3 ranges: 1 Hz to 10 Hz, 10 Hz to 400 Hz, 400 Hz to 100 kHz)

Harmonics 100 order, up to 6 kHz

Appendix A

Measurement Calculation Method

Measurement Function	Calculation Formula	
RMS	$U_{rms} = \sqrt{u^2}$ $U_{\Sigma} = \frac{U_A + U_B + U_C}{3}$	$I_{rms} = \sqrt{i^2}$ $I_{\Sigma} = \frac{I_A + I_B + I_C}{3}$
DC component	$U_{DC} = \bar{u}$	$U_{DC} = \bar{u}$
AC component	$U_{AC} = \sqrt{U_{rms}^2 - U_{DC}^2}$	$I_{AC} = \sqrt{I_{rms}^2 - I_{DC}^2}$
Rectified Mean	$U_{rm} = \overline{ u }$	$I_{rm} = \overline{ i }$
Corrected Rectified Mean	$U_{rmc} = \frac{\pi}{2\sqrt{2}} U_{rm}$	$I_{rmc} = \frac{\pi}{2\sqrt{2}} I_{rm}$
Peak+	$U_{p+} = MAX(u)$	$I_{p+} = MAX(i)$
Peak-	$U_{p-} = MIN(u)$	$I_{p-} = MIN(i)$
Peak to Peak	$U_{pp} = U_{p+} - U_{p-}$	$I_{pp} = I_{p+} - I_{p-}$

Measurement Function	Calculation Formula	
Crest Factor	$U_{cf} = \frac{MAX(U_{p+} , U_{p-})}{U_{rms}}$	$I_{cf} = \frac{MAX(I_{p+} , I_{p-})}{I_{rms}}$
Ripple Factor	$U_{rip} = \frac{U_{pp}}{2U_{dc}}$	$I_{rip} = \frac{I_{pp}}{2I_{dc}}$
Form Factor	$U_{ff} = \frac{U_{rm}}{U_{rms}}$	$I_{ff} = \frac{I_{rm}}{I_{rms}}$
Fundamental Amplitude	$U_{H01} = U(I) $ $U_{\Sigma H01} = \frac{(U_{AH01} + U_{BH01} + U_{CH01})}{3}$	$I_{H01} = I(I) $ $I_{\Sigma H01} = \frac{(I_{AH01} + I_{BH01} + I_{CH01})}{3}$
Fundamental Phase	$\varphi_{U_{H01}} = arg[U(I)]$ Relative to the sync source	$\varphi_{I_{H01}} = arg[I(I)]$ Relative to the sync source
THD	$U_{THD} = \frac{\sqrt{U_{rms}^2 - U_{H01}^2}}{U_{H01}}$	$I_{THD} = \frac{\sqrt{I_{rms}^2 - I_{H01}^2}}{I_{H01}}$
Fundamental Content	$U_{fc} = \frac{U_{H01}}{U_{rms}}$	$I_{fc} = \frac{I_{H01}}{I_{rms}}$
Harmonic Content	$U_{hc} = \frac{\sqrt{U_{rms}^2 - U_{H01}^2}}{U_{rms}}$	$I_{hc} = \frac{\sqrt{I_{rms}^2 - I_{H01}^2}}{I_{rms}}$
hvf	$hvf = \frac{1}{U_N} \sqrt{\sum_{k=2}^{13} \frac{U_{Hk}^2}{k}}, (k \neq 3n \text{ for 3-phase motor})$	

Measurement Function	Calculation Formula
hcf	$hcf = \frac{1}{I_N} \sqrt{\sum_{k=2}^{13} I_{Hk}^2}$
Active Power	$P = \overline{u \cdot i}$ $P_{\Sigma} = \overline{u_A \cdot i_A + u_B \cdot i_B + u_C \cdot i_C}$ <p>Assume $I_N = 0$ for 3P3W3M</p>
Fundamental Active Power	$P_{H01} = U_r(I)I_r(I) + U_j(I)I_j(I)$ $P_{\Sigma H01} = P_{AH01} + P_{BH01} + P_{CH01}$
Reactive Power	$Q = s\sqrt{S^2 - P^2}$ <p>s = +1 when inductive ; s = -1 when capacitive</p> $Q_{\Sigma} = \sqrt{S_{\Sigma}^2 - P_{\Sigma}^2}$
Fundamental Reactive Power	$Q_{H01} = U_j(I)I_r(I) + U_r(I)I_j(I)$
Apparent Power	$S = U_{rms} \cdot I_{rms}$ $S_{\Sigma} = U_A \cdot I_A + U_B \cdot I_B + U_C \cdot I_C$
Fundamental Apparent Power	$S_{H01} = \sqrt{P_{H01}^2 + Q_{H01}^2}$
Power Factor	$\lambda = \frac{P}{S}$ $\lambda_{\Sigma} = \frac{P_{\Sigma}}{S_{\Sigma}}$

Measurement Function	Calculation Formula	
Fundamental Power Factor	$\lambda_{H01} = \frac{P_{H01}}{S_{H01}}$	
Phase Shift	$\varphi = \text{atan2}(Q, P)$ $\varphi_{\Sigma} = \cos^{-1}(\lambda_{\Sigma})$	
Fundamental Phase Shift	$\varphi_{H01} = \text{atan2}(Q_{H01}, P_{H01})$	
Power Fundamental Content	$P_{fc} = \frac{P_{H01}}{P}$	
Efficiency	$\eta = \frac{\sum P_{out}}{\sum P_{in}}$	
Impedance	$Z = \frac{U_{rms}^2}{S}$	
Fundamental Impedance	$Z_{H01} = \frac{U_{H01}^2}{S_{H01}}$	
Impedance Series Equivalence	$R_s = \frac{P}{I_{rms}^2}$	$X_s = \frac{Q}{I_{rms}^2}$
Fundamental Impedance Series Equivalence	$R_{sH01} = \frac{P_{H01}}{I_{H01}^2}$	$X_{sH01} = \frac{Q_{H01}}{I_{H01}^2}$
Impedance Parallel Equivalence	$R_p = \frac{U_{rms}^2}{P}$	$X_p = \frac{U_{rms}^2}{Q}$

Measurement Function	Calculation Formula	
Fundamental Impedance Parallel Equivalence	$R_{pH01} = \frac{U_{H01}^2}{P_{H01}}$	$X_{pH01} = \frac{U_{H01}^2}{Q_{H01}}$
Electrical Energy (Wh)	$W = \frac{1}{3600} \int_0^{t_j} p dt$ $W_{\Sigma} = \frac{1}{3600} \int_0^{t_j} p_{\Sigma} dt$	
Electric Energy +/-	$W_{update} = \frac{1}{3600} \int p dt \text{ in each update cycle}$ <p>if $W_{update} > 0$, $W_+ = W_+ + W_{update}$</p> <p>if $W_{update} < 0$, $W_- = W_- + W_{update}$</p>	
Electric Quantity	$q = \frac{1}{3600} \int_0^{t_j} i dt$	
Electric Quantity +/-	$q_{update} = \frac{1}{3600} \int i dt \text{ in each update cycle}$ <p>if $q_{update} > 0$, $q_+ = q_+ + q_{update}$</p> <p>if $q_{update} < 0$, $q_- = q_- + q_{update}$</p>	
Torque	$T = \overline{torque}$	
Rotation Speed	$n = \overline{speed}$	
Mechanical Power	$P_M = \frac{2\pi}{60} \overline{torque \cdot speed}$	
Mechanical Energy	$E_M = \frac{1}{3600} \int_0^{t_{sr}} P_M dt$	

How to Make More Accurate Measurements

Measurement Error Caused by the Channel Resistance

By wiring a circuit to match the load, you can minimize the effects of power loss on measurement accuracy. The wiring of the source and load is discussed in this section.

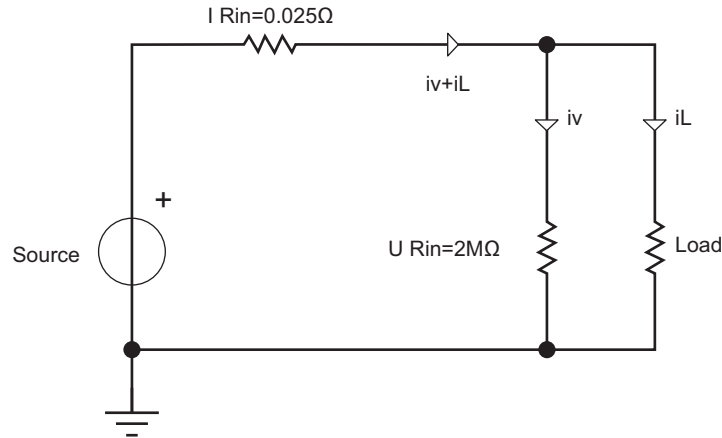

Figure A1. Connect the Voltage Measurement near the load

Connect the voltage measurement circuit near the load (as shown in Figure A1). The current measurement circuit measures the sum of i_L and i_V . i_L (desired current) is the current flowing through the load of the circuit under measurement, and i_V (error current) is the current flowing through the voltage measurement circuit. Because the current flowing through the circuit under measurement is i_L , only i_V reduces measurement accuracy. The input resistance of the voltage measurement circuit of the Analyzer is approximately 2 MΩ. If the input voltage is 1000 V, i_V is approximately 0.5 mA (1000 V/2 MΩ). Only when the load current i_L is 0.5 A or more, the effect of i_V on the measurement accuracy is 0.1% or less.

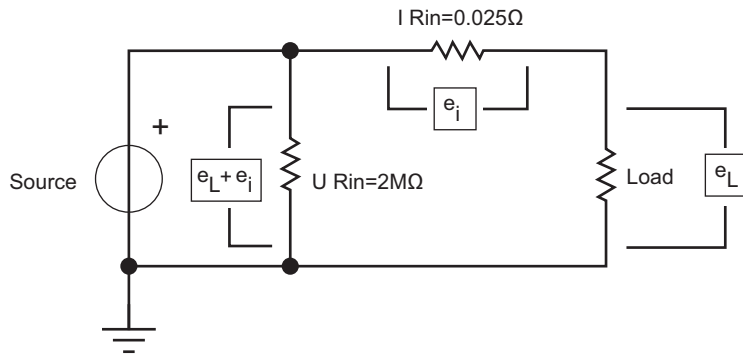

Figure A2. Connect the Voltage Measurement near the source

Connect the voltage measurement circuit near the source (as shown in Figure A2). The voltage measurement circuit measures the sum of e_L and e_i . e_L (desired voltage) is the load voltage, and e_i (error voltage) is the voltage drop across the current measurement circuit. The input resistance of the current measurement circuit of the Analyzer, $I\ Rin$ is approximately 0.025 Ω. If the input current is 10 A, the effect of e_i on the measurement accuracy is approximately 0.25 V (10 A×0.025 Ω). Only when the

load voltage e_L is 250 V or more, the effect on the measurement accuracy is less than 0.1 %. In summary, when measuring low voltage and large current, it is recommended to use the wiring method of the figure above; when measuring high voltage and small current, it is recommended to use the wiring method of the figure below.

Effects of Leakage Capacitance

Each measurement channel of the Analyzer is isolated from each other. However, these isolated channels still have a leakage capacitance C_s relative to the earth, which consists of the distributed capacitance of the instrument itself, the isolation capacitance of the power adapter, and the anti-interference capacitance inside the instrument. In general, the test object of the Analyzer has a higher voltage relative to the earth, and we call this voltage common mode voltage V_{com} . The common mode voltage can generate a current i_{cs} through the leakage capacitance C_s . This current i_{cs} will have a certain impact on the measurement results of the Analyzer.

As shown in Figure A3, during voltage measurement, the current i_{cs} is coupled to the measurement circuit through R_{s+} , R_{s-} and R_{in} . R_{s+} and R_{s-} are internal resistances of the power supply under measurement and R_{in} is the test internal resistance of the power analyzer. The effect on the measurement voltage is: $\Delta U = i_{cs} [R_{s-} // (R_{s+} + R_{in})]$. Because R_{in} is larger, internal resistance of the power supply under measurement R_{s-} has the main impact. R_{s-} is connected to the common terminal (black terminal) of the measurement circuit.

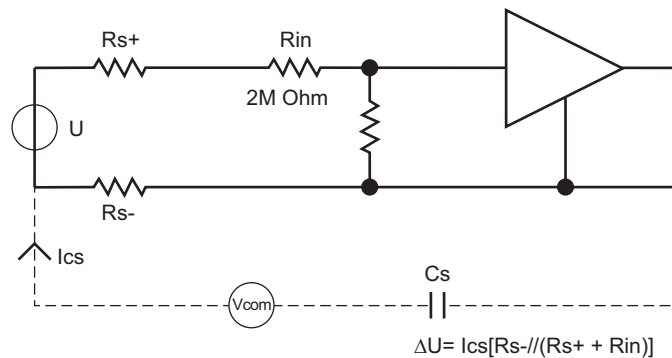

Figure A3. Effects of Leakage Current on Voltage Measurement

During current measurement, the current i_{cs} flows through the test resistance R_{shunt} , and the internal resistance of the test resistance and the common terminal of the measurement circuit R_{s-} and forms a voltage, that is coupled into the measurement circuit. The effect on the measurement current: $\Delta I = i_{cs} [(R_{shunt} + R_{s-}) / R_{shunt}]$, the voltage drop of i_{cs} in R_{shunt} and internal resistance R_{s-} can cause measurement errors.

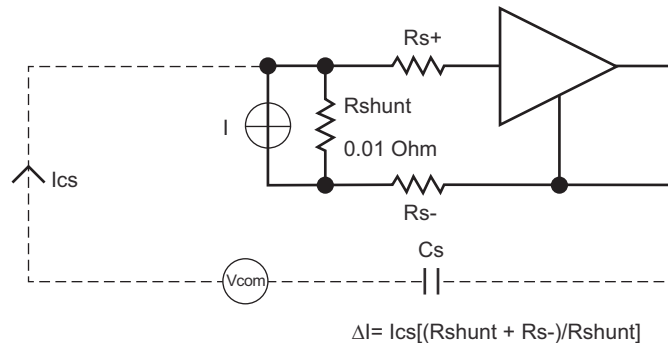

Figure A4. Effects of Leakage Current on Current Measurement

Methods to Reduce the Effect of Leakage Capacitance

1. High frequency components more easily generate current on the leakage capacitance than low frequency components. When measuring the small current with the built-in current channel, if you do not pay attention to the high-frequency components of the current, it is recommended to turn on the 650Hz line filter to effectively reduce the effect of leakage capacitance.
2. Connecting the built-in current channel to terminal N or ground can effectively reduce the effect of leakage capacitance.
3. Disconnecting the power adapter and using battery only can reduce the effect of leakage capacitance.
4. When measuring voltage, if the 2 terminals of the voltage source under measurement do not have the same impedance to the ground, it is recommended to connect the black terminal to the terminal with lower impedance (to avoid leakage current flowing through the internal resistance of the voltage source under measurement).

Broadband Measurement

The Analyzer has a bandwidth of up to 500 kHz and a sample rate of 200 kHz. When the measurement bandwidth is greater than half of the sample rate, aliasing may be caused, the observed waveform is not the real waveform, and the measured frequency is not the real frequency.

To measure a time-based digital quantity, such as RMS, AC and DC components, the results of the measurement after aliasing are still accurate. However, note that if the signal frequency is close to or equal to the sample frequency and its multiples, the measurement results are probably invalid.

If the signal under measurement has a frequency component higher than 100 kHz, and it is not desired to be measured under aliasing, the line filter of the corresponding channel can be turned on according to the required bandwidth.