



PV CHECKS

User manual



Table of contents:

1. PRECAUTIONS AND SAFETY MEASURES	3
1.1. Preliminary instructions	3
1.2. During use	4
1.3. After use	4
1.4. Definition of measurement (overvoltage) category	4
2. GENERAL DESCRIPTION	5
2.1. Introduction	5
2.2. Instrument functions	5
3. PREPARATION FOR USE	6
3.1. Initial checks	6
3.2. Instrument power supply	6
3.3. Storage	6
4. NOMENCLATURE	7
4.1. Instrument description	7
4.2. Keyboard description	8
4.3. Display description	8
4.4. Initial screen	8
5. GENERAL MENU	9
5.1. SET – instrument settings	9
5.1.1. General	9
5.1.2. Measuring unit	10
5.1.3. Date and time	10
5.1.4. Remote unit/Pyranometer	11
5.1.5. Irradiance	12
5.1.6. DC Clamp	12
5.2. EFF – Efficiency test settings for PV installations	13
5.2.1. Instrument settings	13
5.2.2. System parameters	14
5.2.3. Selection of the compensation relationship of temperature effects	15
5.3. LOW Ω – Settings for continuity test with 200mA	16
5.3.1. Instrument settings	16
5.4. M Ω – Settings for insulation measurement	17
5.4.1. Instrument settings	17
5.5. IVCK – Settings for IVCK quick test	18
5.5.1. Instrument settings	18
5.6. DB – Database module management	20
5.6.1. How to define a new PV module	21
5.6.2. How to modify an existing PV module	22
5.6.3. How to delete an existing PV module	22
6. OPERATING INSTRUCTIONS	23
6.1. Measuring efficiency PV plants by using remote unit SOLAR-02	23
6.2. Measuring parameters on PV plant without using SOLAR-02	27
6.3. Quick check on PV modules and strings (IVCK)	29
6.3.1. Foreword	29
6.3.2. Carrying out an IVCK quick test without measuring irradiance	30
6.3.3. Carrying out an IVCK quick test and measuring irradiance	33
6.3.4. Reset Averages	37
6.3.4.1. Anomalous situations when performing IVCK tests	38
6.4. Measurement of insulation on PV modules/strings/fields (M Ω)	39
6.4.1. Foreword	39
6.4.2. Measuring insulation – FIELD mode	39
6.4.3. Measuring insulation – TIMER mode	41
6.4.4. Measuring insulation – STRING mode	43
6.4.4.1. Anomalous situations	45
6.5. Measurement of continuity on PV modules/strings/fields (LOW Ω)	46
6.5.1. Foreword	46
6.5.2. Calibration of measuring cables	46

6.5.3.	Measuring continuity	47
6.5.3.1.	Anomalous situations	49
6.6.	List of display messages	50
7.	STORING DATA	51
7.1.	Saving efficiency measures	51
7.2.	Saving IVCK, $M\Omega$ and $LOW\Omega$ measured results	51
7.3.	Operations with results	53
7.3.1.	Recalling on the display the PV efficiency results	53
7.3.2.	Recalling on the display the results of IVCK, $M\Omega$ and $LOW\Omega$ measurements	54
7.3.2.1.	Accessing the data saved in the memory – Numeric display	55
7.3.3.	Deleting data from the memory	56
8.	CONNECTING THE INSTRUMENT TO THE PC	57
9.	MAINTENANCE	58
9.1.	General information	58
9.2.	Battery replacement	58
9.3.	Cleaning the instrument	58
9.4.	End of life	58
10.	TECHNICAL SPECIFICATIONS	59
10.1.	Technical specifications for PV installation efficiency	59
10.2.	Technical specifications of the IVCK function	60
10.3.	Technical specifications for electrical safety	60
10.4.	Reference standards	61
10.4.1.	General	61
10.5.	General characteristics	61
10.6.	Environmental conditions for use	61
10.7.	Accessories	61
11.	APPENDIX – THEORETICAL OUTLINE	62
11.1.	Efficiency test on PV installations	62
12.	SERVICE	63
12.1.	Warranty conditions	63
12.2.	Service	63

1. PRECAUTIONS AND SAFETY MEASURES

The instrument has been designed in compliance with directive IEC/EN61010-1 relevant to electronic measuring instruments. Before and while carrying out measurements, observe the following indications and read all notes preceded by the symbol  with the utmost attention.

- Do not carry out any voltage or current measurement in humid environments
- Do not carry out any measurements in case gas, explosive materials or flammables are present, or in dusty environments
- Avoid contact with the circuit being measured if no measurements are being carried out
- Avoid contact with exposed metal parts, with unused measuring probes, etc.
- Do not carry out any measurement in case you find anomalies in the instrument such as deformation, breaks, absence of display on the screen, etc.
- Pay special attention when measuring voltages higher than 25V in special environments and 50V in normal environments, since a risk of electrical shock exists.

In this manual, and on the instrument, the following symbols are used:



CAUTION: observe the instructions given in this manual; an improper use could damage the instrument or its components



High voltage danger: electrical shock hazard



Double insulation



DC voltage or current



Connection to earth

1.1. PRELIMINARY INSTRUCTIONS



- This instrument has been designed for use in the environmental conditions specified in § 10.6. Do not use in different environmental conditions.
- The instrument may be used for measuring **VOLTAGE** and **CURRENT** in CAT III 300V with a maximum voltage of 1000VDC between inputs. Do not use on systems exceeding the limit values specified in § 10.1, § 10.2 and § 10.3
- We recommend following the normal safety rules devised to protect the user against dangerous currents and the instrument against incorrect use.
- Only the accessories provided together with the instrument will guarantee safety standards. They must be in good conditions and replaced with identical models, when necessary.
- Check that the batteries are correctly inserted.
- Before connecting the measuring cables to the circuit being measured, check that the desired function has been selected.

1.2. DURING USE

Please carefully read the following recommendations and instructions:



CAUTION

- Failure to comply with the caution notes and/or instructions may damage the instrument and/or its components or be a source of danger for the operator.
- The symbol “” indicates a full charge level of the internal batteries. When battery charge decreases to a minimum level, the symbol “” appears on the display. In this case, stop testing and replace the batteries according to the indications given in § 9.2
- **The instrument is capable of keeping data stored even without batteries.**

1.3. AFTER USE

When measurements are completed, turn off the instrument by pressing and holding the ON/OFF key for some seconds. If the instrument is not to be used for a long time, remove the batteries and follow the instructions given in § 3.3

1.4. DEFINITION OF MEASUREMENT (OVERVOLTAGE) CATEGORY

Standard “IEC/EN61010-1: Safety requirements for electrical equipment for measurement, control and laboratory use, Part 1: General requirements” defines what measurement category, commonly called overvoltage category, is. § 6.7.4: Measured circuits, reads:

Circuits are divided into the following measurement categories:

- **Measurement category IV** is for measurements performed at the source of the low-voltage installation
Examples are electricity meters and measurements on primary overcurrent protection devices and ripple control units.
- **Measurement category III** is for measurements performed on installations inside buildings
Examples are measurements on distribution boards, circuit breakers, wiring, including cables, bus-bars, junction boxes, switches, socket-outlets in the fixed installation, and equipment for industrial use and some other equipment, for example, stationary motors with permanent connection to fixed installation.
- **Measurement category II** is for measurements performed on circuits directly connected to the low-voltage installation
Examples are measurements on household appliances, portable tools and similar equipment.
- **Measurement category I** is for measurements performed on circuits not directly connected to MAINS
Examples are measurements on circuits not derived from MAINS, and specially protected (internal) MAINS-derived circuits. In the latter case, transient stresses are variable; for that reason, the standard requires that the transient withstand capability of the equipment is made known to the user.

2. GENERAL DESCRIPTION

2.1. INTRODUCTION

This instrument has been designed to carry quick checks (IVCK) on photovoltaic modules/strings in order to verify the parameters declared by the manufacturer. In addition, this instrument measures insulation/continuity on PV modules/strings/fields and evaluates the efficiency of a PV field.

IVCK and insulation/continuity measurements may be performed in sequential order IVCK → Insulation → Continuity, or be carried out separately in manual mode.

2.2. INSTRUMENT FUNCTIONS

The instrument has the following features:

Continuity test of protective conductors (LOW Ω)

- Test with test current > 200mA in compliance with standard IEC/EN62446
- Manual calibration of measuring cables.

Measurement of insulation resistance on PV modules/strings (M Ω)

- Test voltages of 250V, 500V, 1000VDC in compliance with standard IEC/EN62446
- 3 measuring modes: Field, Timer, String
- Insulation test of unearthed metal masses

Efficiency evaluation of a PV installation in the short/medium term (EFF)

- Measurement of DC voltage, DC current and DC power at PV modules/strings' outputs
- Measurement of irradiation [W/m²] by means of a reference cell connected to the optional remote unit SOLAR-02
- Measurement of module and environmental temperature by means of probe connected to the optional remote unit SOLAR-02
- Application of compensation relationships to DC efficiency.
- Immediate evaluation of DC efficiency according to the limits set by the user
- Parameter recording of a PV system with 5s to 60min programmable IP

Quick checks (IVCK) in compliance with standard IEC/EN62446

- Measurement of open circuit voltage Voc on PV modules/strings up to 1000VDC
- Measurement of short-circuit current Isc on PV modules/strings up to 15A
- Measurement of irradiation by means of an optional reference cell
- Immediate evaluation (OK/NO) of test results
- Possible connection with the optional remote unit SOLAR-02
- Internal customizable database for managing up to 30 PV modules
- Display of results in OPC and STC conditions

The instrument is provided with backlit display, internal contrast adjustment and a **HELP** key able to give a valid help to the operator while connecting the instrument to the installation. An Auto Power OFF function, which can also be deactivated, is available after approx. 5 minutes' idleness.

3. PREPARATION FOR USE



3.1. INITIAL CHECKS

Before shipping, the instrument has been checked from an electric as well as mechanical point of view. All possible precautions have been taken so that the instrument is delivered undamaged. However, we recommend checking it to detect any damage possibly suffered during transport. In case anomalies are found, immediately contact the Dealer.

We also recommend checking that the packaging contains all components indicated in § 10.7. In case of discrepancy, please contact the Dealer. In case the instrument should be returned, please follow the instructions given in § 12.

3.2. INSTRUMENT POWER SUPPLY

The instrument is battery supplied. For battery type and life, see § 10.5.

The symbol “” indicates a full charge level of the internal batteries. When battery charge decreases to a minimum level, the symbol “” appears on the display. In this case, stop testing and replace the batteries according to the indications given in § 9.2.

The instrument is capable of keeping data stored even without batteries.

The instrument is provided with advanced algorithms to maximize the batteries' life.

During instrument operation, a short pressing of the  key turns on the display's backlighting. In order to save battery efficiency, backlighting automatically turns off after approx. 30 seconds.

A frequent use of backlighting reduces the batteries' life.

3.3. STORAGE

In order to guarantee precise measurement, after a long storage time under extreme environmental conditions, wait for the instrument to come back to normal condition (see § 10.6).

4. NOMENCLATURE

4.1. INSTRUMENT DESCRIPTION

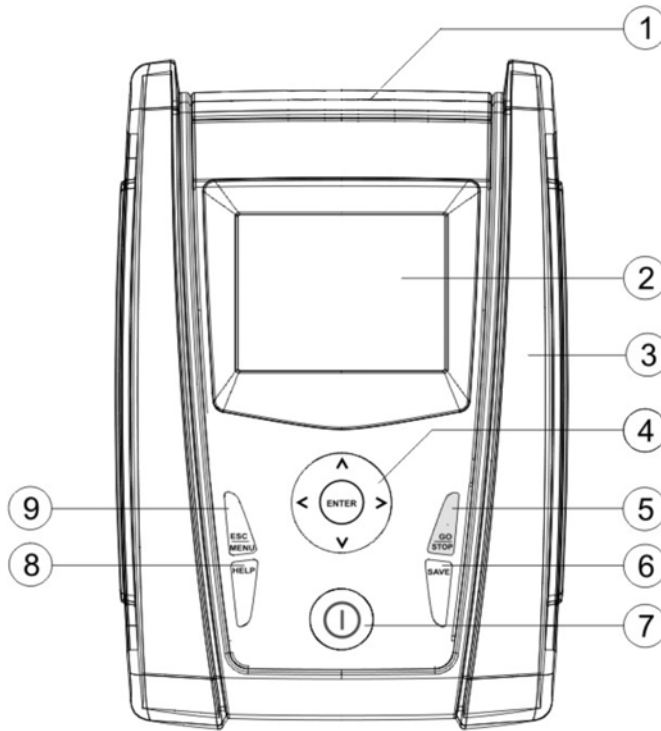

CAPTION:

1. Inputs
2. Display
3. Connector for optical output/USB port
4. Arrow keys/**ENTER** key
5. **GO/STOP** key
6. **SAVE** key
7. **ON/OFF** key
8. **HELP** / key
9. **ESC/MENU** key

Fig. 1: Description of the front part of the instrument

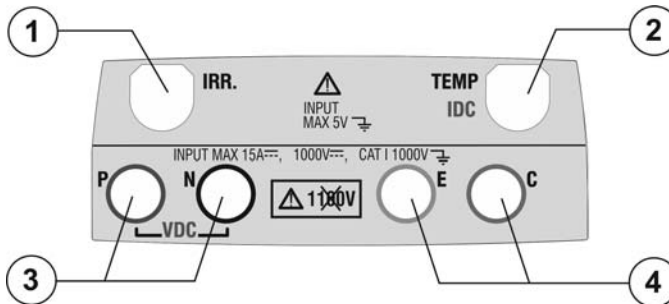

CAPTION:

1. Input for irradiation measuring probe
2. Input for auxiliary temperature measuring probe / DC current clamp (IVCK, EFF)
3. P, N inputs for DC voltage (IVCK, EFF) / Insulation ($M\Omega$) measurement
4. E, C inputs for continuity tests ($LOW\Omega$)

Fig. 2: Description of the upper part of the instrument

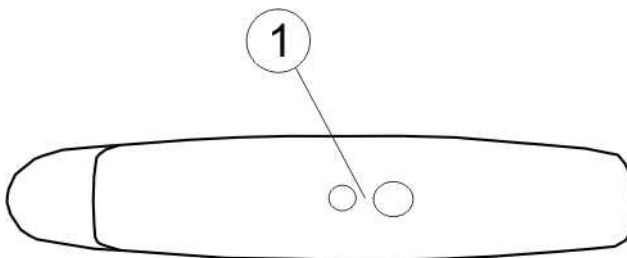

CAPTION:

1. Connector for opto-insulated/USB output cable connection

Fig. 3: Description of the instrument's side

4.2. KEYBOARD DESCRIPTION

The keyboard includes the following keys:



ON/OFF key to switch on/off the instrument



ESC/MENU key to exit the selected menu without confirming and to go back to the main menu



◀ ▶ ▲ ▼ keys to move the cursor inside the various screens in order to select programming parameters

ENTER key to confirm modifications, selected programming parameters and to select the function to be accessed from the menu.



GO/STOP key to start measurements



SAVE key to save the measured values



HELP key (long pressing) to access the on-line help, to view the possible connections between the instrument and the installation.

☀ key (simple pressing) to activate the display's backlighting

4.3. DISPLAY DESCRIPTION

The display is a graphic module with a resolution of 128 x 128 dots. The display's first line indicates the system's date/time and contains the battery charge indicator.

At the bottom of the display, the function of the **ENTER** key and the active mode are displayed.

The symbol  indicates the presence of an active radio connection with the remote unit SOLAR-02.

The flashing symbol  indicates that the instrument is currently searching for a radio connection with the remote unit SOLAR-02.

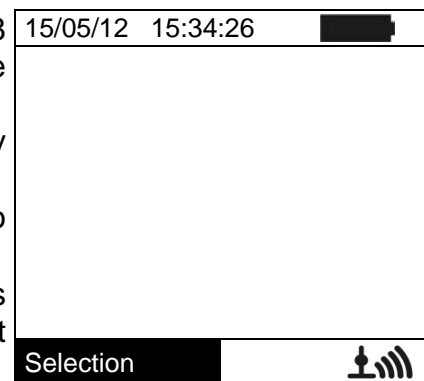

4.4. INITIAL SCREEN

When switching on the instrument, the initial screen appears for a few seconds. It shows:

- The instrument model (PVCHECKs)
- The manufacturer's name
- The presence of the enabled internal module for RF connection
- The serial number (SN:) of the instrument
- The firmware version (FW:) in the instrument's memory
- The date of the last instrument calibration (Calibration date:)

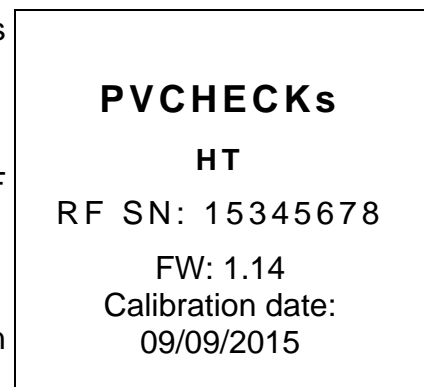

After a few seconds, the instrument switches to the last function selected.

5. GENERAL MENU

Pressing the **ESC/MENU** key in any condition of the instrument displays the general menu screen, in which the instrument may be set, the saved measures can be displayed and the desired measuring function may be selected.

Use the cursor to select one of the options and confirm with **ENTER** to access the desired function.

15/05/12 15:34:26	
IVCK Test mod./strings	
LOWΩ	PE Continuity test
MΩ	Insulation test
EFF	Efficiency test
SET	Settings
DB	Archive modules
MEM	Recall Memory
PC	Trasf. data to PC
Press ENTER to sel.	
	MENU

5.1. SET – INSTRUMENT SETTINGS

Position the cursor onto **SET** by using the arrow keys (**▲**, **▼**) and confirm with **ENTER**. The display shows the screen which lists the different settings of the instrument.

Settings will be maintained also after switching off the instrument.

15/05/12 15:34:26	
General	
Measuring unit	
Date and Time	
Remote Unit - Pyranometer	
Irradiance	
DC Clamp	
Press ENTER to sel.	
	SET

5.1.1. General

- Position the cursor onto **General** by using the arrow keys (**▲**, **▼**) and confirm with **ENTER**.
- The display shows the screen which allows:
 - Setting the instrument language
 - Enabling/disabling the auto power off function
 - Adjusting display contrast
 - Enabling the acoustic signal when pressing a key.
- Use the arrow keys (**▲**, **▼**) for option setting, and select the desired option by means of the arrow keys (**◀**, **▶**).
- Press the **SAVE** key to save the settings made; the message "Data saved" will be displayed for a few seconds. Press the **ESC/MENU** key to exit without saving and go back to the previous screen.

15/05/12 15:34:26	
Language : ◀ English ▶	
Auto Power Off	: NO
Contrast:	: 40
Key Beep	: NO
SAVE to store	
	SET

5.1.2. Measuring unit

This section allows setting the measuring units of some parameters included in the database (DB) for the management of PV modules (see § 5.6) when measuring IVCK.

1. Position the cursor onto “**Measuring Unit**” by using the arrow keys (▲, ▼) and confirm with **ENTER**.
2. The display shows the screen which allows setting the measuring units of the following parameters:
 - Alpha → possible selection: “%/°C” and “mA/°C”
 - Beta → possible selection: “%/°C” and “mV/°C”
 - Gamma → expressed in “%/°C”
 - Voc and Isc tolerance → expressed in “%”
3. Set the desired measuring units by means of the arrow keys (◀, ▶).
4. Press the **SAVE** key to save the settings made; the message “Data saved” will be displayed for a few seconds.
5. Press the **ESC/MENU** key to exit without saving and go back to the previous screen.

15/05/12 15:34:26	
Alpha	: ◀ mA/°C ▶
Beta	: %/°C
Gamma	: %/°C
Tolerance	: %
SAVE to store	
SET	

5.1.3. Date and time

1. Position the cursor onto “**Date and Time**” by using the arrow keys (▲, ▼) and confirm with **ENTER**.
2. The display shows the screen which allows setting the system’s date/time both in the **European (EU)** or in the **USA (US)** format.
3. Set the desired measuring units by means of the arrow keys (◀, ▶).
4. Press the **SAVE** key to save the settings made; the message “Data saved” will be displayed for a few seconds. Press the **ESC/MENU** key to exit without saving and go back to the previous screen.

15/05/12 15:34:26	
Year	: ◀ 2012 ▶
Month	: 05
Day	: 15
Hours	: 09
Minutes	: 53
Format	: EU
SAVE to store	
SET	

5.1.4. Remote unit/Pyranometer

This section allows selecting the type of remote unit to be used (if available) and setting the values of typical parameters (Sensitivity and Alpha) of the reference irradiance cell supplied with the instrument. **The values of these parameters, which are printed on the back label of the cell, depend on the type of PV module being tested.**

1. Position the cursor onto **Remote Unit-Pyranometer** by using the arrow keys (**▲**, **▼**) and confirm with **ENTER**.
2. The display shows the screen which allows selecting the use of the remote unit for EFF or IVCK tests. Possible options are:
 - YES (use of SOLAR-02)
 - NO (no use of SOLAR-02) In case the remote unit SOLAR-02 is not used for **IVCK tests**, it is necessary to set the values of Sensitivity (Sens.) and Alpha parameter of the supplied irradiance cell on the instrument.
3. Set the desired values by means of the keys (**◀**, **▶**)
4. Press the **SAVE** key to save the settings made; the message "Data saved" will be displayed for a few seconds. Press the **ESC/MENU** key to exit without saving and go back to the previous screen

15/05/12 15:34:26	
Remote Unit EFF: ◀ YES ▶	
Remote Unit IVCK: NO	
Sens.	: ◀ 31.0 ▶ mV/kW/m ²
Alpha	: 0.060 %/°C
SAVE to store	
SET	

5.1.5. Irradiance

This section allows setting the minimum irradiance threshold both for IVCK measurement and for efficiency test on a PV installation.

1. Position the cursor onto “**Irradiance**” by using the arrow keys (▲, ▼) and confirm with **ENTER**.
2. The display shows the screen containing “**Min Irr IVCK**”, which allows setting the minimum irradiance threshold expressed in W/m^2 , used by the instrument as a reference during IVCK measurement, and “**Min Irr EFF**”, which allows setting the minimum irradiance threshold expressed in W/m^2 , used by the instrument as a reference while measuring the efficiency of a PV installation. Use the arrow keys (▲, ▼) to switch between the two items.
3. To set the minimum irradiance threshold, use the arrow keys (◀, ▶). To obtain results with the accuracy guaranteed in this manual, we recommend following the instructions given in § 10. The value can be set within the following range: **0 ÷ 800 W/m^2**
4. Press the **SAVE** key to save the settings made; the message “Data saved” will be displayed for a few seconds. Press the **ESC/MENU** key to exit without saving and go back to the previous screen.

15/05/12 15:34:26	
Min IrrIVCK	: ◀ 000 ▶ W/m^2
Min Irr EFF	: ◀ 600 ▶ W/m^2
SAVE to store	
SET	



CAUTION

The “0 W/m^2 ” setting for parameter “Irr min IVCK” allows carrying out IVCK measurements without the following conditions being checked:

- Connection of reference cell to IRR input of the instrument
- Unsteady irradiation values
- Number of modules consistent with the measured open circuit voltage

5.1.6. DC Clamp

This option allows setting a **possible** correction factor K for the DC clamp, in order to improve current measurement. If present, the correction factor is indicated on the rear label of the clamp itself, indicated as:

$$K = X.xxx$$

In case no label is present, set $k = 1.000$

1. Position the cursor onto “**DC Clamp**” by using the arrow keys (▲, ▼) and confirm with **ENTER**.
2. The display shows the item “DC clamp K”, which allows setting the corrective factor in the following range **0.950** to **1.050**. Set the desired values by means of the arrow keys (◀, ▶).
3. Press the **SAVE** key to save the settings made; the message “Data saved” will be displayed for a few seconds. Press the **ESC/MENU** key to exit without saving and go back to the previous screen.

15/05/12 15:34:26	
DC clamp K	: ◀ 1.000 ▶
SAVE to store	
SET	

5.2. EFF – EFFICIENCY TEST SETTINGS FOR PV INSTALLATIONS

The purpose of this measurement is to evaluate the DC efficiency of a photovoltaic installation, with the possibility of obtaining a positive or negative result of the check/recording depending on a limit on the **nDC** parameter, freely set by the user. **For this test, the use of the optional remote unit SOLAR-02 is necessary** (see § 6.1)

5.2.1. Instrument settings

1. Position the cursor onto **EFF** by using the arrow keys (**▲**, **▼**) and confirm with **ENTER**. The display shows the values of the output electrical parameters of the photovoltaic generator.

15/05/12 15:34:26		
Irr	- - -	W/m ²
P _{nom}	3.500	kW
T _c	- - -	°C
T _e	- - -	°C
P _{dc}	0.0	kW
V _{dc}	0.000	V
I _{dc}	0.0	A
n _{dc}	- - -	
GO to Start		
Selection		EFF

2. Press the **ENTER** key. The instrument shows the following options: **System parameters** and **Instrument settings**.
3. Use the arrow keys (**▲**, **▼**) to select “**Instrument settings**” and confirm with **ENTER**. The instrument shows the following screen:

15/05/12 15:34:26		
Irr	- - -	W/m ²
P _{nom}	3.500	kW
T _c	- - -	°C
T _e	- - -	°C
P _{dc}	0.0	kW
V _{dc}	0.000	V
I _{dc}	0.0	A
n _{dc}	- - -	
System parameters		
Instrument settings		
Selection		EFF

4. By using the arrow keys (**◀**, **▶**) it is possible to set:
 - the integration period (IP) which can be used by the instrument when testing the parameters of a PV system. The following values can be selected: **5s, 10s, 30s, 60s, 120s, 300s, 600s, 900s, 1800s, 3600s**.
 - The FS of the DC clamp used for measuring DC current with value selectable between **1A ÷ 3000A**

15/05/12 15:34:26		
IP : ◀ 5 ▶ s		
FS DC clamp : 1000 A		
SAVE to store		
Selection		EFF

5. Press the **SAVE** key to save the settings made; the message “Data saved” will be displayed for a few seconds. Press the **ESC/MENU** key to exit without saving and go back to the previous screen.

5.2.2. System parameters

1. Position the cursor onto **EFF** by using the arrow keys (**▲**, **▼**) and confirm with **ENTER**. The display shows the values of the output electrical parameters of the photovoltaic generator.

15/05/12 15:34:26		
Irr	- - -	W/m ²
P _{nom}	3.500	kW
T _c	- - -	°C
T _e	- - -	°C
P _{dc}	0.0	kW
V _{dc}	0.000	V
I _{dc}	0.0	A
n _{dc}	- - -	
GO to Start		
Selection		EFF

2. Press the **ENTER** key. The instrument shows the following options: **System parameters** and **Instrument settings**

3. Use the arrow keys (**▲**, **▼**) to select “**System Parameters**” and confirm with **ENTER**. The instrument shows the following screen:

15/05/12 15:34:26		
Irr	- - -	W/m ²
P _{nom}	3.500	kW
T _c	- - -	°C
T _e	- - -	°C
P _{dc}	0.0	kW
V _{dc}	0.000	V
I _{dc}	0.0	A
n _{dc}	- - -	
System parameters		
Instrument settings		
Selection		EFF

4. By using the arrow keys (**◀**, **▶**) it is possible to set:

- **P_{max}** → maximum total rated power of PV installation expressed in kW
- **Range** → coefficient of power variation with temperature, characteristic parameter of PV modules (range: **-1.00 ÷ -0.01%/C**)
- **NOCT** → rated operating temperature of the cell, characteristic parameter of PV modules (typically in the following range: 42 ÷ 48°C)
- **T_e, T_c** → setting of default values of environmental and (T_e) and PV module (T_c) temperatures. These values are taken into consideration by the instrument only when no auxiliary probe is connected to the remote unit SOLAR-02 (range: **T_e = 0°C ÷ 80°C; T_c = 0°C ÷ 100°C**)
- **n_{DC} Lim** → minimum limit of DC efficiency (default value: 0.85 , range: **0.01 ÷ 1.15**)
- **Corr. Type** → Setting of the compensation relationship on the calculation of P_{dc} power and the maximization of DC efficiency (see § 5.2.3).

15/05/12 15:34:26		
P _{max} : : ◀ 3.500 ▶ kW		
Gamma	:	-0.45 %/°C
NOCT	:	45 °C
T _e	:	40 °C
T _c	:	45 °C
n _{DC} Lim:	:	0.85
Corr.Type.	:	T. Env.
SAVE to Store		
		EFF

5.2.3. Selection of the compensation relationship of temperature effects

This option allows selecting the relationship to be used to correct the measurements performed according to the modules' temperature as regards the calculation of nDC efficiency. The following modes are available:

- T.Mod.: Correction factor Rfv2 related to PV module Temp. (Italian guideline CEI-82-25)
- T.Env.: Correction factor Rfv2 related to environmental Temp. (Italian guideline CEI-82-25)
- nDC: nDC correction according to module temperature



CAUTION

If it's performed a test according to Italian guideline it is recommended to select "T.Env." correction

Corr. Type	Temperature used (Tcel)	Calculation of nDC	Ref.
T.Mod.	$T_{cel} = T_{moduli_M\grave{s}}$	$R_{fv2} = \begin{cases} 1 & (\text{se } T_{cel} \leq 40^{\circ}\text{C}) \\ 1 - (T_{cel} - 40) \times \frac{ \gamma }{100} & (\text{se } T_{cel} > 40^{\circ}\text{C}) \end{cases}$ <p style="text-align: center;">hence</p> $nDC = \frac{P_{dc}}{\left[R_{fv2} \times \frac{G_p}{G_{STC}} \times P_n \right]}$	CEI 82- 25
T.Env.	$T_{cel} = \left(T_{amb} + (NOCT - 20) \times \frac{Irr}{800} \right)$		
nDC	$T_{cel} = T_{moduli_M\grave{s}}$	$nDC = \frac{G_{STC}}{G_p} \times \left[1 + \frac{ \gamma }{100} \times (T_{cel} - 25) \right] \times \frac{P_{dc}}{P_n}$	---

where:

Symbol	Description	Measuring unit
G_p	Irradiance measured on PV module surface	[W/m ²]
G_{STC}	Standard Irradiance = 1000	[W/m ²]
P_n	Rated Power = sum of all Pmax values of the section of the PV plant being measured	[kW]
P_{dc}	DC power measured at the PV generator's output	[kW]
R_{fv2}	Correction factor depending on the Temperature of PV Cells (Tcel) measured or calculated according to the type of selected correction relationship	
$ \gamma $	Absolute value of the thermal coefficient of Pmax of the PV modules included in the plant section being measured.	[%/°C]
NOCT	(Normal Operating Cell Temperature) = Temperature the cells under reference conditions are brought to (800W/m ² , 20°C, AM=1.5, air speed =1m/s).	[%/°C]

For further details see § 11.1

5.3. LOW Ω – SETTINGS FOR CONTINUITY TEST WITH 200MA

The purpose of this measurement is to test the continuity of protective conductors and equipotential ones (e.g. from rod to earth and connected foreign earth) and earth rods of SPDs on PV installations. The test must be carried out using a test current > 200mA according to the prescriptions of IEC/EN62446 guideline

5.3.1. Instrument settings

1. Position the cursor onto **LOW Ω** by using the arrow keys (**▲**, **▼**) and confirm with **ENTER**. The display shows the following screen:

15/05/12 15:34:26		
RPE max	:	1 Ω
Rcal	:	- - - Ω
Rpe	=	- - - Ω
Itest	=	- - - mA
Selection		LOWΩ

2. Press the **ENTER** key. The instrument shows the following options: **Settings** and **Leads calibration**
3. Use the arrow keys (**▲**, **▼**) to select “**Settings**” and confirm with **ENTER**. The instrument shows the following screen:

15/05/12 15:34:26		
RPE max	:	1 Ω
Rcal	:	- - - Ω
Rpe	=	- - - Ω
Itest	=	- - - mA
Leads calibration		
Settings		
Selection		LOWΩ

4. Using the arrow keys (**◀**, **▶**) it is possible to set the maximum limit value of Rpe resistance which the instrument uses as a reference while measuring.
5. Press the **SAVE** key to save the settings made; the message “Data saved” will be displayed for a few seconds. Press the **ESC/MENU** key to exit without saving and go back to the previous screen.

15/05/12 15:34:26		
RPE max : ◀ 01 ▶ Ω		
SAVE to store		
Selection		LOWΩ



CAUTION

The settings saved for max RPE also affect the settings for the Continuity test contained in the IVCK measurement (MENU → IVCK)

5.4. MΩ – SETTINGS FOR INSULATION MEASUREMENT

5.4.1. Instrument settings

- Position the cursor onto **MΩ** by using the arrow keys (**▲**, **▼**) and confirm with **ENTER**. The display shows the following screen:

15/05/12 15:34:26		
Ins. Test	: 1000	V
Ri min	: 1.0	MΩ
Mode	: Field	
Vtest	- - - V - - - V	
Ri(+)	- - -	MΩ
Ri(-)	- - -	MΩ
Rp	- - -	MΩ
Selection		MΩ ▼

- Press the **ENTER** key. The instrument shows the option: **Settings:**

- Confirm with **ENTER**. The instrument shows the following screen:

15/05/12 15:34:26		
Ins. Test	: 1000	V
Ri min	: 1.0	MΩ
Mode	: Field	
Vtest	- - - V - - - V	
Ri(+)	- - -	MΩ
Ri(-)	- - -	MΩ
Rp	- - -	MΩ
Settings		
Selection		MΩ ▼

- Use the arrow keys (**▲**, **▼**) for option setting, and select the desired option by means of the arrow keys (**◀**, **▶**). The following parameters can be set:

- **Ins. Test** → test voltage: 250, 500, 1000VDC
- **Mode** → operating modes: Field, Timer, String
- **Ri min** → minimum limit value for insulation resistance
- **Test time** → maximum value of test time (only for TIMER mode) with a maximum value of 300s in steps of 1s.

15/05/12 15:34:26		
Ins. Test : ◀ 1000 ▶ V		
Ri min	: 1.00	MΩ
Mode	: TIMER	
Test time	: 10s	
SAVE to store		
		MΩ

- Press the **SAVE** key to save the settings made; the message "Data saved" will be displayed for a few seconds. Press the **ESC/MENU** key to exit without saving and go back to the previous screen.



CAUTION

The settings saved for test voltage also affect the settings for the insulation measurement contained in the IVCK measurement (MENU → IVCK)

5.5. IVCK – SETTINGS FOR IVCK QUICK TEST

The purpose of this measurement is to verify the functionality of the connections and of the strings in a photovoltaic field, according to the provisions of standard IEC/EN62446 by measuring the open circuit voltage and the short-circuit current at operating conditions and referred to STC (via the optional measurement of irradiation) and providing immediate results regarding the measurement just carried out, both in absolute terms and by comparison with the strings previously tested. The test also allows carrying out (if selected) the continuity test and an insulation measurement in a sequence.

5.5.1. Instrument settings

- Position the cursor onto **IVCK** by using the arrow keys (**▲**, **▼**) and confirm with **ENTER**. The display shows the following screen:

15/05/12 15:34:26		
Module	: SUNPWR318	
Vdc	: 0.0	V
Irr	: 0	W/m ²
Tc	: Auto	°C
Voc, Isc:		
Ri(1000V)	=	- - - MΩ
Rpe (Cal)	=	- - - Ω
Selection		IVCK

- Press the **ENTER** key. The instrument shows the following options: **Settings**, **Reset Averages** (see § 6.3.4) and **Leads calibration** (see § 6.5.2).
- Use the arrow keys (**▲**, **▼**) to select “**Settings**” and confirm with **ENTER**. The instrument shows the following screen:

15/05/12 15:34:26		
Module	: SUNPWR318	
Vdc	: 0.0	V
Irr	: 0	W/m ²
Tc	: Auto	°C
Voc, Isc:		
Ri(1000V)	=	- - - MΩ
Rpe (Cal)	=	- - - Ω
Leads calibration		
Reset Averages		
Settings		
Selection		IVCK

- Use the arrow keys (**▲**, **▼**) for option setting, and select the desired option by means of the arrow keys (**◀**, **▶**). The following parameters can be set:
 - **Module** → type of module being tested
 - **Mod. N x Str.** → number of modules in the string. Allowable values **1 ÷ 50**
 - **Temp** → temperature measuring method. Possible options:
 - “**Auto**” → automatic measurement (**recommended**) carried out according to the measured value of the

15/05/12 15:34:26		
Module: ◀ SUNPWR210 ▶		
Mod.Nx Str	: 01	
Temp	: Manual	
	25	°C
Tol. Voc	: 05% (+4%)	
Tol. Isc	: 05% (+4%)	
Ins. Test	: 1000	V
Ri min	: 1.0	MΩ
RPE Test	: 2	Ω
SAVE to store		
Selection		IVCK

modules' Voc.

“Manual” → setting, made by the operator, of the known temperature value of the module in the line below.

Aux → temperature measurement with auxiliary probe PT1000.

- **Tol. Voc (%)** → percentage value of the desired limit tolerance (set by the operator according to his/her own requirements) for the measurement of Voc carried out by the instrument. Allowable values: **0% ÷ 25%**. The value between brackets (4%) indicates the reading error of the instrument in Voc measurement.
 - **Tol. Isc (%)** → percentage value of the desired limit tolerance (set by the operator according to his/her own requirements) for the measurement of Isc carried out by the instrument. Allowable values: **0% ÷ 25%**. The value between brackets (4%) indicates the reading error of the instrument in Isc measurement.
 - **Ins Test** → enabling/disabling of insulation measurement and setting of test voltage. Possible options: **OFF, 250V, 500V, 1000V**. With enabled function, the line “Ri min” appears, which allows setting the minimum limit threshold in the range **0.1 ÷ 100MΩ**
 - **RPE Test** → enabling/disabling of continuity test and setting of the limit threshold value for measurement. Possible options **OFF, 1Ω ÷ 5Ω** in steps of 1Ω
5. Press the **SAVE** key to save the settings made; the message “Data saved” will be displayed for a few seconds. Press the **ESC/MENU** key to exit without saving and go back to the previous screen.



CAUTION

The settings saved for test voltage for the insulation measurement carried out within the IVCK function also affect the settings for the single measurement (MENU → MΩ).

5.6. DB – DATABASE MODULE MANAGEMENT

The meter allows managing **up to a maximum of 30 different types of PV modules**, further to a DEFAULT module (not editable and not erasable) which can be used as reference case when no piece of information about the type of module being tested is available.

The parameters, **referred to 1 module**, which can be set are described below in Table 1 together with their measuring range, resolution and validity condition.

Symbol	Description	Range	Resol.	Conditions
Nms	Number of modules per string	1 ÷ 50	1	
Pmax	Maximum rated power of module	50 ÷ 4800W	1W	$\left \frac{P_{\max} - V_{mpp} \cdot I_{mpp}}{P_{\max}} \right \leq 0.01$
Voc	Open-circuit voltage	15.00 ÷ 99.99V 100.0 ÷ 320.0V	0.01V 0.1V	Voc ≥ Vmpp
Vmpp	Voltage on maximum power point	15.00 ÷ 99.99V 100.0 ÷ 320.0V	0.01V 0.1V	Voc ≥ Vmpp
Isc	Short-circuit current	0.5 ÷ 15.00A	0.01A	Isc ≥ Impp
Impp	Current on maximum power point	0.5 ÷ 15.00A	0.01A	Isc ≥ Impp
Toll -	Negative tolerance for Pmax provided by the module manufacturer	0% ÷ 25.0% 0 ÷ 99W	0.1% 1	100*Tol/Pnom < 25
Toll +	Positive tolerance for Pmax provided by the module manufacturer	0 ÷ 25% 0 ÷ 99W	0.1% 1	100*Tol*/Pnom < 25
Alpha	Isc temperature coefficient	-0.100 ÷ 0.100%/°C -15.00 ÷ 15.00mA/°C	0.001%/°C 0.01mA/°C	100*Alfa / Isc ≤ 0.1
Beta	Voc temperature coefficient	-0.99 ÷ -0.01%/°C -0.999 ÷ -0.001V/°C	0.01%/°C 0.001V/°C	100*Beta/Voc ≤ 0.999
Gamma	Pmax temperature coefficient	-0.99 ÷ -0.01%/°C	0.01%/°C	
NOCT	Rated working temperature of cell	0 ÷ 100°C	1°C	
Tech.	Effects due to module technology	STD (standard) CAP(capacitive eff.)		
Rs	Internal serial resistance	0.00 ÷ 10.00Ω	0.01Ω	

Table 1: Typical parameters of PV modules

CAUTION



- The “**Tech**” item is referred to the choose of the technology of the module on test. Select the “STD” option for test on “STANDARD” PV modules, “CAP” option for test on higher capacitive effects PV modules
- A wrong choice of the type of technology can lead to a negative outcome of the final test.

5.6.1. How to define a new PV module

- Position the cursor onto **DB** by using the arrow keys (**▲**, **▼**) and confirm with **ENTER**. The display shows the screen which contains:
 - The type of PV module
 - The values of the parameters associated to the module (see Table 1)
- Use the arrow keys (**◀**, **▶**) to select the “DEFAULT” module type and confirm with **ENTER**.

15/05/12 15:34:26	
Model : ◀ DEFAULT ▶	
▲	
P max	= 185 W
V oc	= 44.5 V
V mpp	= 37.5 V
I sc	= 5.40 A
I mpp	= 4.95 A
Toll-	= 0 %
▼	
Selection	DB

- Press the **ENTER** key, select the “New” command (which allows defining a new module) and confirm again with **ENTER**. Use the arrow keys (**▲**, **▼**) to scroll the list of parameters.

15/05/12 15:34:26	
Model : ◀ DEFAULT ▶	
▲	
P max	= 185 W
V oc	= 44.5 V
V mpp	= 37.5 V
I sc	= 5.40 A
I mpp	= 4.95 A
Toll-	= 0 %
▼	
New	
Selection	DB

- By using the internal virtual keyboard it is possible to define the name of the module (e.g. SUNPOWER 210) by means of the arrow keys (**▲**, **▼**, **◀**, **▶**). Press **ENTER** to digit any character of the desired name.
- Press the **SAVE** key to save the name of the new module thus defined or the **ESC/MENU** key to exit without saving.

15/05/12 15:34:26	
Model :	
▲	
P max	= 185 W
V oc	= 44.5 V
KEYBOARD	
SUNPOWER 210	
A B C D E F G H I J K L M N O P	
Q R S T U V W X Y Z - + 0 1 2 3	
4 5 6 7 8 9 SPACE DEL	
SAVE / ESC	

- Insert the value of each parameter (see Table 1) according to the possible datasheet of the Manufacturer.). Position the cursor onto the parameter to be defined by using the arrow keys (**▲**, **▼**) and set the value using the arrow keys (**◀**, **▶**). Keep the arrow keys (**◀**, **▶**) pressed to carry out a quick setting of the values.
- Press the **SAVE** key to save the settings or the **ESC/MENU** key to exit without saving.

15/05/12 15:34:26	
Model : SUNPWR 210	
▲	
P max	= ◀ 0 ▶ W
V oc	= 0.0 V
V mpp	= 0.0 V
I sc	= 0.00 A
I mpp	= 0.00 A
Toll-	= 0 %
▼	
DB	

CAUTION



- If the value of any parameter is unknown, press and hold the **HELP** key for a few seconds to set the default values.
- Upon pressing the **SAVE** key, the instrument checks the conditions indicated in Table 1
- and, if one or more of these conditions are not fulfilled, one of the error messages listed in § 6.6 is shown on the display. The instrument does not save the configuration set before any error is solved.

5.6.2. How to modify an existing PV module

1. Select the PV module to be modified from the internal database by means of the arrow keys (◀, ▶).
2. Press the **ENTER** key and select the “**Modify**” command using the arrow key (▼).
3. Confirm selection with **ENTER**.

15/05/12 15:34:26		
Model ◀ SUNPWR210 ▶		
▲		
Pmax	= 210	W
Voc	= 47.70	V
Vmpp	= 40.00	V
Isc	= 5.75	A
New		
Modify		
Delete		
Delete all		
Selection		DB

4. By using the internal virtual keyboard it is possible to define again the name of the module or leave it unchanged by means of the arrow keys (▲, ▼, ◀, ▶). Press **ENTER** to digit any character of the desired name.
5. Press the **SAVE** key to save the name of the new module thus defined or to access the new parameter setting.

15/05/12 15:34:26															
Model: ◀ SUNPWR210 ▶															
▲															
Pmax	= 185	W													
Voc	= 44.5	V													
KEYBOARD															
SUNPOWER 210															
A	B	C	D	E	F	G	H	I	J	K	L	M	N	O	P
Q	R	S	T	U	V	W	X	Y	Z	-	+	0	1	2	3
4	5	6	7	8	9	SPACE									DEL
SAVE / ESC															

6. Change the value of the desired parameters by using the arrow keys (▲, ▼) and set the value using the arrow keys (◀, ▶). Keep the arrow keys (◀, ▶) pressed to carry out a quick setting of the values. If the value of any parameter is unknown, press and hold the **HELP** key for a few seconds to set the default values.
7. Press the **SAVE** key to save the settings made or the **ESC/MENU** key to exit without saving. In this case, the instrument shows the message “Data not saved”.

15/05/12 15:34:26		
Model : SUNPWR 210		
▲		
Pmax	= ◀ 210 ▶	W
Voc	= 47.70	V
Vmpp	= 40.00	V
Isc	= 5.75	A
Imp	= 5.25	A
Toll-	= 5	%
▼		
		DB

5.6.3. How to delete an existing PV module

1. Select the PV module from the internal database by means of the arrow keys (◀, ▶).
2. Press the **ENTER** key and select the “**Delete**” command by means of the arrow key (▼) to delete the selected module.
3. Press the **ENTER** key and select the “**Delete all**” command by means of the arrow key (▼) to delete all modules in the database.
4. Confirm the selection with **ENTER** or press **ESC/MENU** to exit.

15/05/12 15:34:26		
Model : ◀ SUNPWR210 ▶		
▲		
Pmax	= 210	W
Voc	= 47.70	V
Vmpp	= 40.00	V
Isc	= 5.75	A
New		
Modify		
Delete		
Delete all		
Selection		DB



CAUTION

It is not possible to modify nor delete the “DEFAULT” PV module which is a factory setting.

6. OPERATING INSTRUCTIONS

6.1. MEASURING EFFICIENCY PV PLANTS BY USING REMOTE UNIT SOLAR-02

For the sake of simplicity, further in this section, the word “string” will be used, although often the term “photovoltaic field” would be more correct. From the point of view of the instrument, the management of a single string or of more parallel strings (PV field) is identical. The instrument PVCHECKs (Master) allows measuring the efficiency of PV installations in combination with the optional remote unit SOLAR-02, which the irradiance and temperature probes are connected to. This remote unit is capable of communicating with the Master unit (to manage data synchronization and download) via a radiofrequency (RF) connection, which is active up to a maximum distance of **1m** between the units.

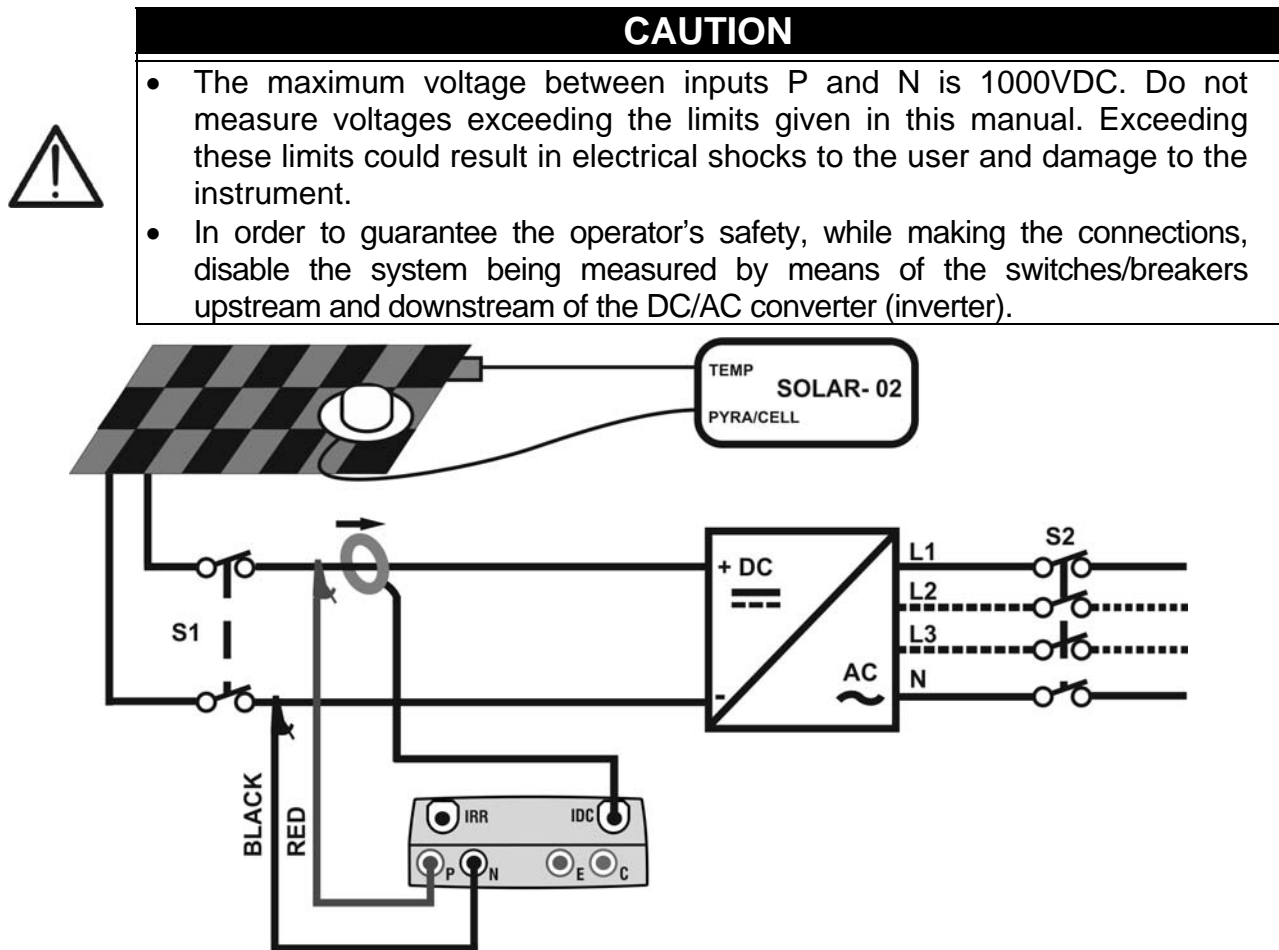

Fig. 4: Connection of instrument for efficiency measurement on a PV installation

1. Check and, if necessary, set the sensitivity of the reference cell on SOLAR-02 consistently with the type of PV modules which will be measured (please refer to the user manual of SOLAR-02).
2. We recommend making a preliminary evaluation of the value of irradiation on the surface of the PV modules being tested by means of unit SOLAR-02 (operating independently) and the reference cell.
3. Switch on PVCHECKs, check and, if necessary, change the instrument settings relevant to the type of remote unit, to the minimum irradiation threshold, to the full scale of the DC clamp, to the integration period and to the parameters of the system being measured (see § 5.1.4, § 5.1.5, § 0, § 5.2.1 and § 5.2.2).

4. In order to guarantee the operator's safety, disable the system being measured by means of the switches/breakers upstream and downstream of the DC/AC converter (inverter).
5. Bring PVCHECKs and SOLAR-02 nearer (maximum distance of 1m between them). **All instruments must be switched on** (see the User Manual of SOLAR-2 for further details).
6. On PVCHECKs, press the **MENU** key, select the function **EFF** and press **ENTER**; wait for the two units to start communicating with each other. This condition is highlighted by the contemporary presence of the following indicators:
 - Symbol steady (not flashing) on the display of PVCHECKs
 - Symbol steady (not flashing) on the display of SOLAR-02
7. Connect the inputs **P** and **N** respectively to the positive and negative output of the string, respecting the colours indicated in Fig. 4
8. Connect the output connector of the DC clamp to the **IDC** input.



CAUTION

BEFORE CONNECTING THE DC CLAMP TO THE CONDUCTORS

Switch on the clamp, check the LED indicating the status of the clamp's internal batteries (if present), select the correct range, press the **ZERO** key on the DC clamp and check on the display of PVCHECKs the actual zeroing of the corresponding **Idc** value (values up to **0.02A** are acceptable).

9. Connect the DC current clamp to the positive output conductor of the string, **respecting the direction of the arrow** found on the clamp itself as indicated in Fig. 4
10. Position the clamp so that the jaw is not near the negative conductor.

11. The display shows the first screen which contains the values of the output electrical parameters of the module/string.

15/05/12 15:34:26 █		
Irr	- - -	W/m ²
Pnom	3.500	kW
Tc	45	°C
Ta	30	°C
Pdc	3.125	kW
Vdc	389	V
Idc	8.01	A
ndc	- - -	
Go to Start		
Selection	EFF	

12. Before starting measuring, check for the presence of symbol "" steady on the display, which indicated a correct RF connection with the remote unit SOLAR-02.

13. Keeping the remote unit SOLAR-02 always close to the main unit, press the **GO/STOP** key on PVCHECKs to start testing. The message "**Waiting start recording...**" appears on the display of the main unit and "**HOLD**" is shown on the display of SOLAR-02, together with an indication of the time remaining, expressed in seconds, until "00" is reached.

15/05/12 15:34:26 █		
Irr	- - -	W/m ²
Pnom	3.500	kW
Tc	45	°C
Ta	30	°C
Pdc	3.125	kW
Vdc	389	V
Idc	8.01	A
ndc	- - -	
Waiting start recording...		
Selection	EFF	

14. Upon reaching “00” after pressing the **GO/STOP** key, the test is started and the two units are synchronized with each other. In these conditions the message “**Recording running...**” is displayed on the main unit and “**Recording...**” is displayed by SOLAR-02.

15/05/12 15:35:00		
Irr	- - -	W/m ²
Pnom	3.500	kW
Tc	45	°C
Te	30	°C
Pdc	3.125	kW
Vdc	389	V
Idc	8.01	A
ndc	- - -	
Recording running...		
Selection		EFF

15. At any time it will be possible to analyze the current recording status by pressing the **MENU** key. The following information will be shown:
- Starting date and time of recording
 - The value set for the integration period (IP)
 - The number of periods elapsed from the beginning of the recording
 - The remaining memory capacity for recording



15/05/12 15:35:00	
Start	15/05/12 15:30:00
Period:	5s
IP Number	61
Rec. Time	0d 1h
Recording running...	

Press the **ESC** key to exit the screen

16. Now it is possible to bring the unit SOLAR-02 near the PV strings to measure irradiation and temperature by means of the relevant probes. When the distance between the unit SOLAR-02 and PVCHECKs does not allow a RF connection, on the display of SOLAR-02, the symbol “” flashes for approx. 30s and then disappears, while PVCHECKs continues searching for the connection for approx. 1 minute.
17. Position the reference cell onto the surface of the PV modules. Please refer to the relevant User Manual for a correct assembly.
18. Put the temperature sensor in contact with the rear side of the module and fasten it with some tape; avoid touching it with your fingers in order not to alter the measurement result.
19. Wait for a few seconds to allow the probes to reach a steady measure and then connect the irradiation probe to input **PYRA/CELL** and the temperature probe to input **TEMP** of unit SOLAR-02.
20. Wait for the message “**READY**” to appear on the display of SOLAR-02 to indicate that the unit has detected the data with solar irradiation > minimum threshold set (see § 5.1.5).
21. **With the message “READY” shown on the display, wait for approximately 1 minute in order to take a certain number of samples.**
22. Disconnect the irradiation and temperature probes from unit SOLAR-02 and bring the unit near PVCHECKs (max distance 1m).
23. The main unit PVCHECKs must be in **EFF** mode. If there is no flashing symbol “”, press key to activate the RF connection search again.
24. Press key on SOLAR-02 to activate the RF connection again. Consequently, the main unit will show the message “active radio connection”.
25. To stop testing, press the **GO/STOP** key on the instrument and confirm with **ENTER** that you want to stop recording.
26. The display of the unit SOLAR-02 will display the message “**SEND**” to indicate that the data will be transferred to the main unit.

27. After the automatic data transfer phase, the instrument will display:

- Do not show any results if do not exist on the PV installation a “**stable irradiance**” condition more than the minimum irradiance threshold
- Display the best performance values if during the recording, the Irradiance values reached the “**stable**” condition and its values were higher than the minimum irradiance threshold
- **Unable to carry out the analysis** if irradiance has never reached a steady value higher than the minimum threshold set, or if no value exists which is valid during the whole recording (nDC > 1.15).

15/05/12 15:35:00		
Irr	712	W/m ²
P _{nom}	3.500	kW
T _c	45	°C
T _e	30	°C
P _{dc}	3.125	kW
V _{dc}	389	V
I _{dc}	8.01	A
n _{dc}	0.88	
Analys Results		
Selection	<input checked="" type="checkbox"/>	EFF 

28. Press **SAVE** to save the results obtained (see § 7.1) or **ESC** to exit the screen and go back to the initial screen.

6.2. MEASURING PARAMETERS ON PV PLANT WITHOUT USING SOLAR-02

The “PV installation efficiency” test carried out without using the optional remote unit SOLAR-02 only allows evaluating output electrical parameters of a string or a photovoltaic field (quantities, V_{dc} , I_{dc} and P_{dc}), which can be periodically recorded with a programmable integration period (see § 5.2.1). In this mode, the values of Irradiation, T_e , T_c , the **nDC** efficiency value are not evaluated and no result is provided by the instrument.

CAUTION



- The maximum voltage between inputs P and N is 1000VDC. Do not measure voltages exceeding the limits given in this manual. Exceeding these limits could result in electrical shocks to the user and damage to the instrument.
- In order to guarantee the operator’s safety, while making the connections, disable the system being measured by means of the switches/breakers upstream and downstream of the DC/AC converter (inverter).

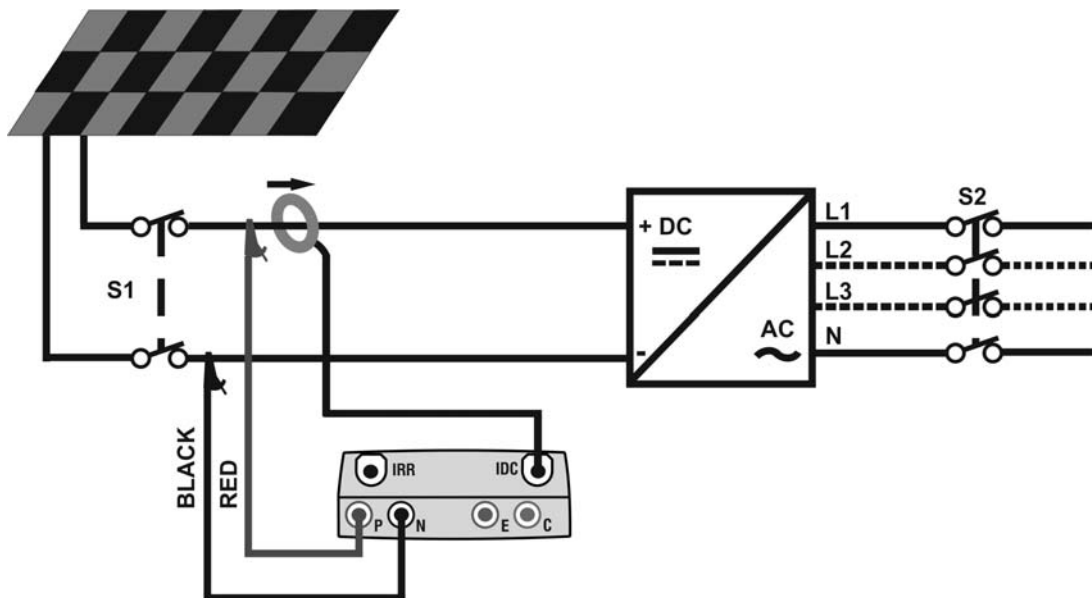

Fig. 5: Instrument connection for measuring PV installation parameters without SOLAR-02

1. Select the option “NO” as regards the type of remote unit to be used during EFF test (see § 5.1.4), set the full scale of the DC clamp (see § 5.2.1), a possible correction factor of the DC clamp (see § 0), the integration period and the rated power of the system (see § 5.2.1 and § 5.2.2).
2. In order to guarantee the operator’s safety, disable the system being measured by means of the switches/breakers upstream and downstream of the DC/AC converter (inverter)
3. Connect the inputs **P** and **N** respectively to the positive and negative output of the string, respecting the colours indicated in Fig. 5
4. Connect the output connector of the DC clamp to the **IDC** input.

CAUTION



BEFORE CONNECTING THE DC CLAMP TO THE CONDUCTORS
Switch on the clamp, check the LED indicating the status of the clamp’s internal batteries (if present), select the correct range, press the ZERO key on the DC clamp and check on the display of PVCHECKs the actual zeroing of the corresponding I_{dc} value (values up to 0.02A are acceptable).

5. Connect the DC current clamp to the positive output conductor of the string, **respecting the direction of the arrow** found on the clamp itself as indicated in Fig. 5. Position the clamp so that the jaw is not near the negative conductor.

6. The display shows the first screen which contains the values of the output electrical parameters of the module/string.

15/05/12 15:34:26		
Irr	- - -	W/m ²
Pnom	3.500	kW
Tc	- - -	°C
Te	- - -	°C
Pdc	3.125	kW
Vdc	389	V
Idc	8.01	A
ndc	- - -	
Go to Start		
Selection	EFF	

7. Press **GO/STOP** key on PVCHECKs to start the test. The message **“Waiting start recording...”** appears on the display of the instrument until “00” is reached.

15/05/12 15:34:26		
Irr	- - -	W/m ²
Pnom	3.500	kW
Tc	45	°C
Te	30	°C
Pdc	3.125	kW
Vdc	389	V
Idc	8.01	A
ndc	- - -	
Waiting start recording...		
Selection	EFF	

8. Upon reaching “00” after pressing the **GO/STOP** key, the test is started. Under these conditions, the message **“Recording running...”** appears on the instrument’s display.

15/05/12 15:35:00		
Irr	- - -	W/m ²
Pnom	3.500	kW
Tc	45	°C
Te	30	°C
Pdc	3.125	kW
Vdc	389	V
Idc	8.01	A
ndc	- - -	
Recording running...		
Selection	EFF	

9. At any time it will be possible to analyze the current recording status by pressing the **MENU** key. The following information will be shown:

- Starting date and time of recording
- The value set for the integration period
- The number of periods elapsed from the beginning of the recording
- The remaining memory capacity for recording

15/05/12 15:35:00	
Start :	14/02/00 17:18:00
Period:	5s
IP Number	61
Rec. Time	0d 1h
Recording running...	

Press the **ESC** key to exit the screen

10. To stop testing, press the **GO/STOP** key on the instrument and confirm with **ENTER** that you want to stop recording.
11. Press **SAVE** to save the results obtained (see § 7.1) or **ESC** to exit the screen and go back to the initial screen.

6.3. QUICK CHECK ON PV MODULES AND STRINGS (IVCK)

6.3.1. Foreword

This function carries out a series of quick tests on a PV module/string, measuring in a sequence:

- The Voc voltage and the short-circuit current Isc according to the prescriptions of standard IEC/EN62446 with the possibility of measuring (by using the relevant probes) also the irradiance and module temperature values.
- Insulation resistance measurement (if enabled – see § 5.5.1), only carried out in **STRING** mode (see § 6.4.4) i.e. by automatically producing an internal short circuit between the input terminals **P** and **N** and measuring between this short-circuit point and the input terminal **E**.
- Continuity test of protective conductors (if enabled – see § 5.5.1) with 200mA between the input terminals **E** and **C** of the instrument.

Irradiance measurement can be carried out in one of the following modes:

- Reference cell directly connected to PVCHECKS
- Reference cell connected to SOLAR-02 in RF connection with PVCHECKS

Irradiance measurements are always carried out in real time; it is therefore impossible to start a “remote” recording of irradiance values through SOLAR-02.

If the minimum irradiance threshold (see § 5.1.5) is:

- = 0 → the instrument does not control the presence of the reference cell, irradiance changes, number of modules and does not display error messages in case it is impossible to calculate Voc and Isc values transposed under STC. This mode is suitable to carry out a test session on a considerable number of strings as quickly as possible.
- > 0 (recommended >700W/m²) → the instrument carries out all tests provided for I-V test, manages all conditions and error messages for I-V test (wrong num. of mod., temp. out of range, cell presence, min. irr., etc.) and calculated the values of Voc and Isc under STC. This mode is recommended whenever accurate tests are to be carried out on modules/strings being examined.

In general, the result page will include:

- Description of the module used
- Irradiance and temperature values (if available)
- Average values of Voc and Isc calculated as average of the corresponding values under OPC on the last 10 tests saved in the memory. If the number of tests is < 10, the average is calculated on the number of available tests. The first test will display dashes in the field “average values” as there are no previous tests on which to calculate an average.
- The values of Voc and Isc measured under OPC as well as any partial result (only available if STC values are not available) obtained by comparison with average values.
- The values of Voc and Isc calculated under STC (if available) and any partial result obtained by comparing the values calculated under STC with the nominal ones (inserted in DB modules).
- The overall test outcome (OK(NO)). The overall result will be calculated based on the partial results obtained:
 - Based on partial results under STC (if these are available)
 - Based on partial results under OPC (if STC values are not available)

The instrument will not display any overall result if no partial result is available.

6.3.2. Carrying out an IVCK quick test without measuring irradiance



CAUTION

- The maximum voltage between inputs P, N, E and C is 1000VDC. Do not measure voltages exceeding the limits given in this manual
- Do not perform test on PV modules or strings connected to the DC/AC converter
- **The maximum current which can be measured by the instrument is 15A. Before carrying out the measures of IVCK and Insulation in "STRING" mode, always ensure that the instrument is connected to ONE STRING and not more strings in parallel to avoid possible damage of it**

1. Switch on the instrument by pressing the **ON/OFF** key.
2. Check that the remote unit SOLAR-02 is not selected (see § 5.1.4 – setting NO)
3. Check that the value of minimum irradiance set in section “Irradiance” (see § 5.1.5) is equal to **0**.

2. Position the cursor onto **IVCK** by using the arrow keys (**▲**, **▼**) and confirm with **ENTER**. The display shows the screen to the side: The meaning of the parameters is the following:

15/05/12 15:34:26	
Module	: SUNPWR318
Vdc	: 0.0 V
Irr	: - - - W/m ²
Tc	: - - -
Voc, Isc:	
Ri(1000V)	- - - MΩ
Rpe (Cal)	- - - Ω
Selection	IVCK

- **Module** → type of module being tested
- **Vdc** → value of output voltage from module/string measured in real time
- **Irr** → value of irradiation measured in real time
- **Tc** → value of module temperature (see § 5.5.1)
- **Voc, Isc** → section with display of result OK/NO of Voc and Isc measurement
- **Ri()** → the value in brackets may be NO/selected test voltage (see § 5.5.1). The value of Ri indicates the insulation resistance
- **Rpe()** → the value in brackets may be NO, Cal or NoCal (see § 5.5.1). The value of Rpe indicates the result of the continuity test.

3. Press the **ENTER** key, select “**Settings**” and confirm again with **ENTER**. Set the instrument as indicated in § 5.5.1
4. If necessary, press the **ENTER** key, select “**Reset Averages**” and confirm again with **ENTER**. If necessary, carry out this operation as indicated in § 6.3.4
5. If necessary, press the **ENTER** key, select “**Leads calibration**” and confirm again with **ENTER**. If necessary, carry out this operation as indicated in § 6.5.2
6. Connect the instrument to the module/string being tested and, if necessary, to the main earth node of the system and to the earthed metal masses as shown in Fig. 6. In particular, connect the negative output pole of the module/string to terminal N and the positive output pole of the module/string to terminal P.

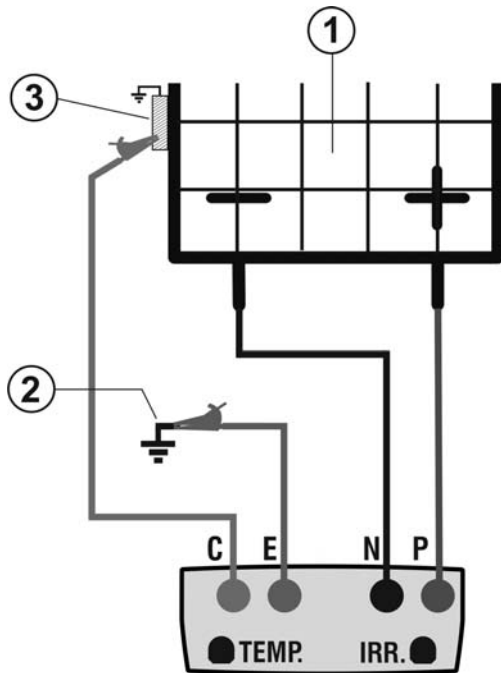
CAPTION:

E: Green cable
 C: Blue cable
 P: Red cable
 N: Black cable

1. PV module/string
 2. Main system earthing
 3. Earthed metal structure in the system

Fig. 6: Connection for IVCK test without irradiance measurement

CAUTION

Upon pressing the **GO/STOP** key, different error messages can be displayed by the instrument (see § 6.6) and, therefore, the test cannot be started. Check and eliminate, if possible, the problem causing the error message before going on with the test.

9. Press **GO/STOP** to start the test. In case no error conditions occur, the instrument displays the message "**Measuring...**" and the measure of open-circuit voltage between the terminals P and N and of short-circuit current (for Isc values $\leq 15A$).

15/05/12 15:34:26	
Module	: SUNPWR318
Vdc	: 548.0 V
Irr	: 0 W/m ²
Tc	: Auto °C
Voc,Isc:	
Ri(1000V)	- - - MΩ
Rpe (Cal)	- - - Ω
Measuring...	
Selection	IVCK

10. When Voc and Isc measurements are complete, the message "OK" is shown in case the result of the test is positive (measured values within the tolerances set on the instrument)

15/05/12 15:34:26	
Module	: SUNPWR318
Vdc	: 548.0 V
Irr	: 0 W/m ²
Tc	: Auto °C
Voc,Isc: OK	
Ri(1000V)	116 MΩ OK
Rpe (Cal)	- - - Ω
Measuring...	
Selection	IVCK

11. With insulation measurement selected, the instrument goes on with the test keeping terminals P and N short-circuited, and carrying out the test between this point and terminal E for the time necessary to obtain a steady value.

12. The value of insulation resistance is shown in field "Ri" and the message "OK" appears in case the result of the test is positive (measured value higher than the minimum limit value set on the instrument).

13. With continuity measurement selected, the instrument goes on by opening the short-circuit and carrying out the test between terminals E and C.
14. The value of resistance in the continuity test is shown in field "Rpe" and the message "OK" appears in case the result of the test is positive (measured value lower than the maximum limit value set on the instrument).
15. The message "**Outcome:OK**" is finally shown by the instrument in case the result of all performed tests is positive.

15/05/12 15:34:26	█
Module	: SUNPWR318
Vdc	: 548.0 V
Irr	: 0 W/m2
Tc	: Auto °C
Voc, Isc:	OK
Ri(1000V)	116 MΩ OK
Rpe (Cal)	2.00 Ω OK
Outcome: OK	
▼	IVCK

16. Press the arrow key ▼ to show the following page in which the values of parameters Voc and Isc are shown. It shows:
- The module being used
 - The average values of Voc and Isc under OPC conditions
 - The values of Voc and Isc measured under OPC and the relevant partial results obtained by comparison with the average values.

15/05/12 15:34:26	█
Module:	SUNPWR210
Irr	---W/m2
Tc (AUTO)	---°C
VocAvg@OPC	647V
IscAvg@OPC	5.43A
Voc@OPC	647V OK
Isc@OPC	5.35A OK
Voc@STC	---V
Isc@STC	---A
Outcome: OK	
▲	IVCK

In general:

$$Esito Voc_{@OPC} = OK \quad se \quad 100 \times \left| \frac{VocAvg_{@OPC} - Voc_{@OPC}}{VocAvg_{@OPC}} \right| \leq (Tol Voc + 4\%)$$

$$Esito Isc_{@OPC} = OK \quad se \quad 100 \times \left| \frac{IscAvg_{@OPC} - Isc_{@OPC}}{IscAvg_{@OPC}} \right| \leq (Tol Isc + 4\%)$$

- The overall value of the results:
 - OK: if all results under OPC are OK,
 - NO if one of the results under OPC is NO

17. Press the ▲ key to go back to the previous screen.
18. Press the **SAVE** key to store the test result in the instrument's memory (see § 7.2) or the **ESC/MENU** key to exit the screen without saving and go back to the main measuring screen.



CAUTION

The average values of Voc and Isc are displayed in the results' page. These values include the average values of Voc and Isc under OPC conditions calculated as mean of the last 10 tests previously saved. If the user has carried out and saved a number of tests <10 or reset the average values (see § 6.3.4) the average value displayed during test N+1 will be calculated on the available N values.

6.3.3. Carrying out an IVCK quick test and measuring irradiance



CAUTION

- The maximum voltage between inputs P, N, E and C is 1000VDC. Do not measure voltages exceeding the limits given in this manual.
- Do not perform test on PV modules or strings connected to the DC/AC converter
- **The maximum current which can be measured by the instrument is 15A. Before carrying out the measures of IVCK and Insulation in "STRING" mode, always ensure that the instrument is connected to ONE STRING and not more strings in parallel to avoid possible damage of it**

1. Switch on the instrument by pressing the **ON/OFF** key.
2. Irradiance measurement is carried out in one of the following modes:
 - Measurement by reference cell directly connected to PVCHECKS
 - Measurement by reference cell connected to a connected SOLAR-02 unit RF with PVCHECKS
3. Check that the settings of remote unit SOLAR-02 are consistent with the type of measurement to be carried out (see § 5.1.4).
4. Check the minimum irradiance value set (see § 5.1.5).
5. Position the cursor onto **IVCK** by using the arrow keys (**▲**, **▼**) and confirm with **ENTER**. The display shows the screen to the side: The meaning of the parameters is the following:

15/05/12 15:34:26	
Module	: SUNPWR318
Vdc	: 0.0 V
Irr	: 0 W/m ²
Tc	: Auto °C
Voc, Isc:	
Ri(1000V)	- - - MΩ
Rpe (Cal)	- - - Ω
Selection	IVCK

 - **Module** → type of module being tested
 - **Vdc** → value of output voltage from module/string measured in real time
 - **Irr** → value of irradiation measured in real time
 - **Tc** → value of module temperature (see § 5.5.1)
 - **Voc, Isc** → section with display of result OK/NO of Voc and Isc measurement
 - **Ri()** → the value in brackets may be NO/selected test voltage (see § 5.5.1). The value of Ri indicates the insulation resistance
 - **Rpe()** → the value in brackets may be NO, Cal or NoCal (see § 5.5.1). The value of Rpe indicates the result of the continuity test.
6. Press the **ENTER** key, select "**Settings**" and confirm again with **ENTER**. Set the instrument as indicated in § 5.5.1
7. If necessary, press the **ENTER** key, select "**Average Reset**" and confirm again with **ENTER**. Carry out this operation as indicated in § 6.3.4
8. If necessary, press the **ENTER** key, select "**Cable calibration**" and confirm again with **ENTER**. Carry out this operation as indicated in § 6.5.2
9. Mount the rod onto the disc of the optional accessory M304 and keep it in touch with the module's surface. **Make sure that the shadow cast by the rod onto the disc falls within the "limit internal circle" on the disc itself (see Fig. 7).** If this is not the case, the incidence angle between the sun rays and the module surface is too high and, therefore, the measurements carried out by the instrument CANNOT be considered reliable. Repeat the same operations at another daytime.
10. Fasten the bracket to the module by using the supplied set of screws and mount the reference cell on it, if possible with **output terminals facing downwards**. Rotate the

cell until it rests on the tang found on the bracket so that the cell is perfectly parallel to the surface of the module, then fix it with the relevant screws provided.

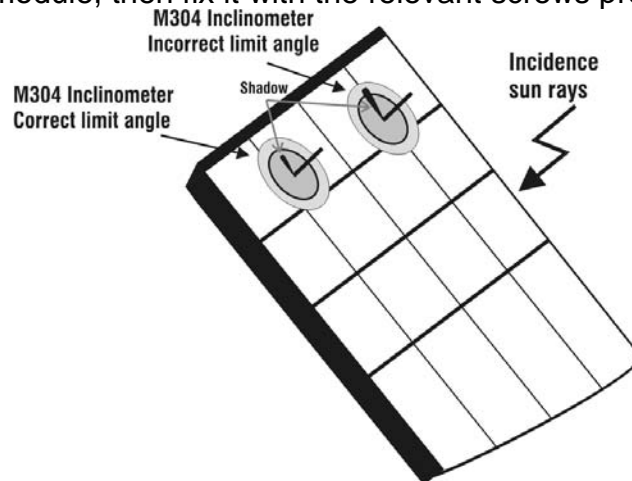

Fig. 7: Positioning the inclinometer M304

11. Connect the output of the cell corresponding to the type of module being tested to the **IRR.** input of the instrument using the cable supplied with the cell, or to the **PYRA/CELL** input of the remote unit SOLAR-02, if used (see Fig. 8 and Fig. 9)
12. If used, connect the temperature sensor to the **TEMP** input of the instrument and fasten it to the backside of the module under a cell using some adhesive tape. As an alternative, connect the sensor to the **TEMP** input of the remote unit SOLAR-02, if used (see Fig. 8 and Fig. 9)
13. Connect the instrument to the module/string being tested and, if necessary, to the main earth node of the system and to the earthed metal masses as shown in Fig. 8 and Fig. 9. In particular, connect the negative output pole of the module/string to terminal N and the positive output pole of the module/string to terminal P.



CAUTION

In case the remote unit SOLAR-02 is used for measuring irradiance, make sure that the RF communication with the master unit PVCHECKS is always active (symbol “” on and steady on the display).

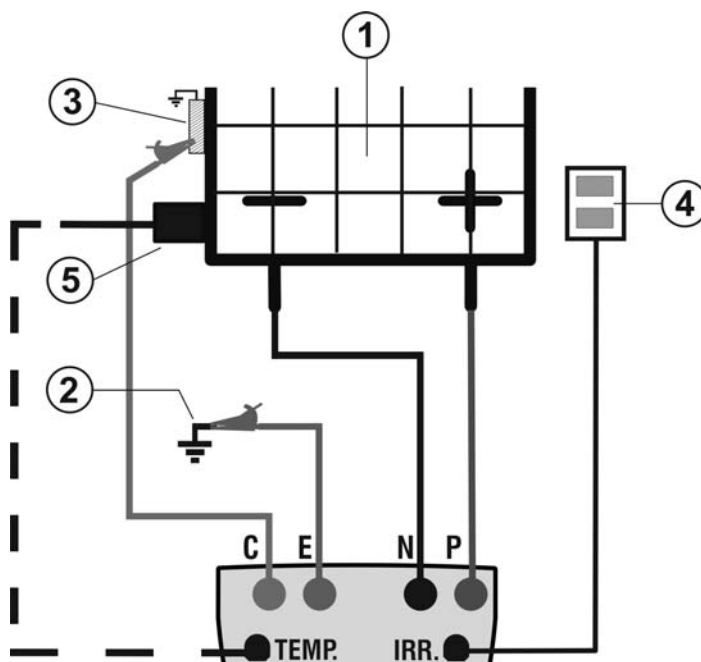

CAPTION:

E: Green cable
 C: Blue cable
 P: Red cable
 N: Black cable

1. PV module/string
2. Main system earthing
3. Earthed metal structure in the system
4. Reference cell for irradiance measurement
5. Temperature sensor (if required)

Fig. 8: Connection for IVCK test with direct irradiance measurement

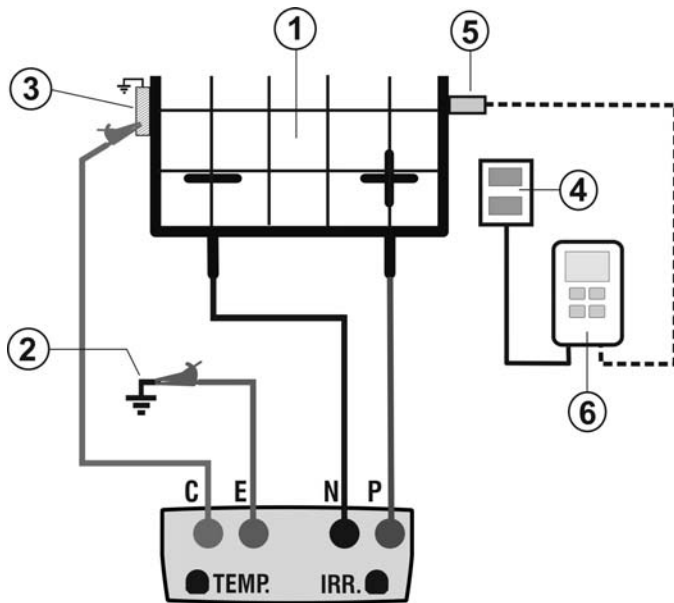

CAPTION:

- E: Green cable
 - C: Blue cable
 - P: Red cable
 - N: Black cable
1. PV module/string
 2. Main system earthing
 3. Earthed metal structure in the system
 4. Reference cell for irradiance measurement
 5. Temperature sensor (if required)
 6. Unità remota SOLAR-02Remote unit SOLAR-02

Fig. 9: Connection for IVCK test with irradiance measurement through SOLAR-02

14. In the initial screen of **IVCK** mode, the following values are displayed in real time:

- **Module** → type of module being tested
- **Vdc** → value of output voltage from module/string
- **Irr** → irradiance (from a direct measurement or SOLAR-02 connected via RF)
- **Tc** → module temperature (in MAN or AUX mode) and the relevant measuring mode, or “- - -” in AUTO mode
- In case, the symbol “” of RF connection with SOLAR-02

15/05/12 15:34:26		
Module	: SUNPWR318	
Vdc	: 548.0 V	
Irr	: 856 W/m ²	
Tc	: Auto °C	
Voc, Isc:		
Ri(1000V)	- - -	MΩ
Rpe (Cal)	- - -	Ω
Selezione		IVCK



CAUTION

Upon pressing the **GO/STOP** key, different error messages can be displayed by the instrument (see § 6.6) and, therefore, the test cannot be started. Check and eliminate, if possible, the problem causing the error message before going on with the test.

15. Press **GO/STOP** to start the test. In case no error conditions occur, the instrument displays the message “**Measuring...**” and the measure of open-circuit voltage between the terminals P and N and of short-circuit current (for Isc values ≤15A).

15/05/12 15:34:26		
Module	: SUNPWR318	
Vdc	: 548.0 V	
Irr	: 856 W/m ²	
Tc	: Auto °C	
Voc, Isc:		
Ri(1000V)	- - -	MΩ
Rpe (Cal)	- - -	Ω
Measuring...		
Selection		IVCK

16. When Voc and Isc measurements are complete, the message “OK” is shown in case the result of the test is positive (measured values within the tolerances set on the instrument)

15/05/12 15:34:26	
Module	: SUNPWR318
Vdc	: 548.0 V
Irr	: 856 W/m2
Tc	: Auto °C

17. With insulation measurement selected, the instrument goes on with the test keeping terminals P and N short-circuited, and carrying out the test between this point and terminal E for the time necessary to obtain a steady value.

Voc, Isc:	OK	
Ri(1000V)	116	MΩ OK
Rpe (Cal)	- - -	Ω

18. The value of insulation resistance is shown in field “Ri” and the message “OK” appears in case the result of the test is positive (measured value higher than the minimum limit value set on the instrument).

Measuring...	
Selection	IVCK

19. With continuity measurement selected, the instrument goes on by opening the short-circuit and carrying out the test between terminals E and C.

15/05/12 15:34:26	
Module	: SUNPWR318
Vdc	: 548.0 V
Irr	: 856 W/m2
Tc	: Auto °C

20. The value of resistance in the continuity test is shown in field “Rpe” and the message “OK” appears in case the result of the test is positive (measured value lower than the maximum limit value set on the instrument).

Voc, Isc:	OK	
Ri(1000V)	116	MΩ OK
Rpe (Cal)	2.00	Ω OK

21. The message “**Outcome:OK**” is finally shown by the instrument in case the result of all performed tests is positive.

Outcome: OK	
▼	IVCK

22. Press the arrow key ▼ to show the following page in which the values of parameters Voc and Isc are shown. It shows:

15/05/12 15:34:26	
Module:	SUNPWR210
Irr	--- W/m2
Tc (AUTO)	57 °C
VocAvg@OPC	647V
IscAvg@OPC	5.43A
Voc@OPC	647V
Isc@OPC	5.35A
Voc@STC	787V OK
Isc@STC	5.72A OK

- The module being used
- The value of irradiance
- The value of temperature of the module
- The average values of Voc and Isc under OPC
- The values of Voc and Isc measured under OPC
- The values of Voc and Isc calculated under STC and the relevant partial results obtained by comparison with the nominal values.

Outcome: OK	
▲	IVCK

In general:

$$Esito Voc_{@STC} = OK \quad se \quad 100 \times \left| \frac{VocNom_{@STC} - Voc_{@STC}}{VocNom_{@STC}} \right| \leq (Tol Voc + 4\%)$$

$$Esito Isc_{@STC} = OK \quad se \quad 100 \times \left| \frac{IscNom_{@STC} - Isc_{@STC}}{IscNom_{@STC}} \right| \leq (Tol Isc + 4\%)$$

The rated values of Voc and Isc are the values found in the instrument’s internal modules’ DB (see § 5.6).

- The overall value of the results:

- OK: if all results under STC are OK,
- NO if one of the results under STC is NO

23. Press the **▲** key to go back to the previous screen.

24. Press the **SAVE** key to store the test result in the instrument's memory (see § 7.2) or the **ESC/MENU** key to exit the screen without saving and go back to the main measuring screen.



CAUTION

The average values of Voc and Isc are displayed in the results' page. These values include the average values of Voc and Isc under OPC conditions calculated as mean of the last 10 tests previously saved. If the user has carried out and saved a number of tests <10 or reset the average values (see § 6.3.4) the average value displayed during test N+1 will be calculated on the available N values.

6.3.4. Reset Averages

If irradiance values are measured, the instrument provides a result by comparing the values measured with the average values calculated according to the previously saved measured.

In this case, the average values calculated by the instrument are therefore particularly important. In case a new measurement campaign is started with significant variations in irradiance or temperature, it is advisable to set the average reference values to zero in order to make new calculations based on new measurements.

To reset the average values, please keep to the following steps:

1. In IVCK mode, press the **ENTER** key, select "**Reset Averages**" and confirm by pressing **ENTER** again to zero the average values calculated until that moment.

15/05/12 15:34:26	
Module	: SUNPWR318
Vdc	: 0.0 V
Irr	: 0 W/m ²
Tc	: Auto °C
Voc, Isc:	
Ri(1000V)	- - - MΩ
Rpe (Cal)	- - - Ω
Leads calibration	
Reset Averages	
Settings	
Selection	IVCK

The average values are automatically reset also **modifying and then saving** one of the following parameters:

- Type of PV module
- Number of modules per string

The average values are not reset if the operator changes operating mode and then goes back to this mode.

6.3.4.1. Anomalous situations when performing IVCK tests

1. In case the instrument detects a voltage higher than 1000V at terminals P-N, P-E and N-E, it does not carry out the test, gives out a long sound and displays the message "Vin > 1000".

15/05/12 15:34:26	
Module	: SUNPWR318
Vdc	: 0.0 V
Irr	: 0 W/m ²
Tc	: Auto °C
Voc, Isc:	
Ri(1000V)	- - - MΩ
Rpe (Cal)	- - - Ω
Vin > 1000	
Selection	IVCK

2. In case the instrument detects a voltage lower than 15V at terminals P and N, it does not carry out the test, gives out a long sound and displays the message "Low voltage".

15/05/12 15:34:26	
Module	: SUNPWR318
Vdc	: 0.0 V
Irr	: 0 W/m ²
Tc	: Auto °C
Voc, Isc:	
Ri(1000V)	- - - MΩ
Rpe (Cal)	- - - Ω
Low voltage	
Selection	IVCK

3. In case the instrument detects a voltage higher than > 5V at terminals E and C, it does not carry out the test, gives out a long sound and displays the message "Voltage > Lim".

15/05/12 15:34:26	
Module	: SUNPWR318
Vdc	: 0.0 V
Irr	: 0 W/m ²
Tc	: Auto °C
Voc, Isc:	
Ri(1000V)	- - - MΩ
Rpe (Cal)	- - - Ω
Voltage > Limit	
Selection	IVCK

4. In case the instrument detects an Isc current higher than 15A, it does not carry out the test, gives out a long sound and displays the message "Isc current too high".

15/05/12 15:34:26	
Module	: SUNPWR318
Vdc	: 0.0 V
Irr	: 0 W/m ²
Tc	: Auto °C
Voc, Isc:	
Ri(1000V)	- - - MΩ
Rpe (Cal)	- - - Ω
Isc current too high	
Selection	IVCK

6.4. MEASUREMENT OF INSULATION ON PV MODULES/STRINGS/FIELDS (MΩ)

6.4.1. Foreword

The purpose of this function is to measure the insulation resistance of the active conductors of a module, string, of a whole PV field and of possible unearthed metal masses according to the prescriptions IEC/EN62446 guideline. In general, the instrument measures insulation in the following modes:

- **FIELD** mode → used for measuring insulation resistance of a **PV field** (photovoltaic generator) consisting in one or more strings connected in parallel. The instrument performs the measurement on the Positive and Negative poles of the PV field.
- **TIMER** mode → the instrument measures continuously (with a max duration of 300s) on terminal “P” only, displaying the minimum resistance value obtained at the end of the selected time. It may be used for measuring the insulation resistance of more unearthed metal masses.
- **STRING** mode → used for measuring insulation only on single PV modules or strings, automatically creating an internal short-circuit between the Positive and Negative poles, with no need to use an external switch to short-circuit the positive and negative terminals and measuring between this short-circuit point and the installation earthing.

6.4.2. Measuring insulation – FIELD mode

1. Position the cursor onto **MΩ** by using the arrow keys (▲, ▼) and confirm with **ENTER**. The display shows the screen to the side:

15/05/12 15:34:26		█
Ins. Test	: 1000	V
Ri min	: 1.0	MΩ
Mode	: Field	
Vtest	- - -	V - - - V
Ri(+)	- - -	MΩ
Ri(-)	- - -	MΩ
Rp	- - -	MΩ
Selection		MΩ ▼

2. Press the **ENTER** key, activate “**Settings**” and possibly change the desired parameters (see § 5.4). The following parameters are shown on the display:

- **Ins. Test** → selected test voltage (250, 500 or 1000VDC)
- **Ri min** → minimum limit threshold for insulation measurement
- **Mode** → measuring mode: FIELD
- **Vtest** → real test voltages applied respectively between the Positive pole and the Negative pole of the field respect the earthing
- **Ri (+)** → insulation resistance measurement between the Positive pole of the PV field and the earthing
- **Ri (-)** → insulation resistance measurement between the Negative pole of the PV field and the earthing
- **Rp** → final value of the measurement obtained by the parallel of Ri(+) e Ri(-) values which is compared with the Ri min limit by the instrument
- ▼ key → access to the second page with the measured values of VPN, VEP and VEN voltages

15/05/12 15:34:26		█ ▲
VPN	- - -	V
VEP	- - -	V
VEN	- - -	V
Selection		MΩ

3. Connect the instrument to the PV field being tested and to the main earth node of the system shown in Fig. 10. In particular, connect the negative output pole of the PV field to terminal N and the positive output pole of the PV field to terminal P.

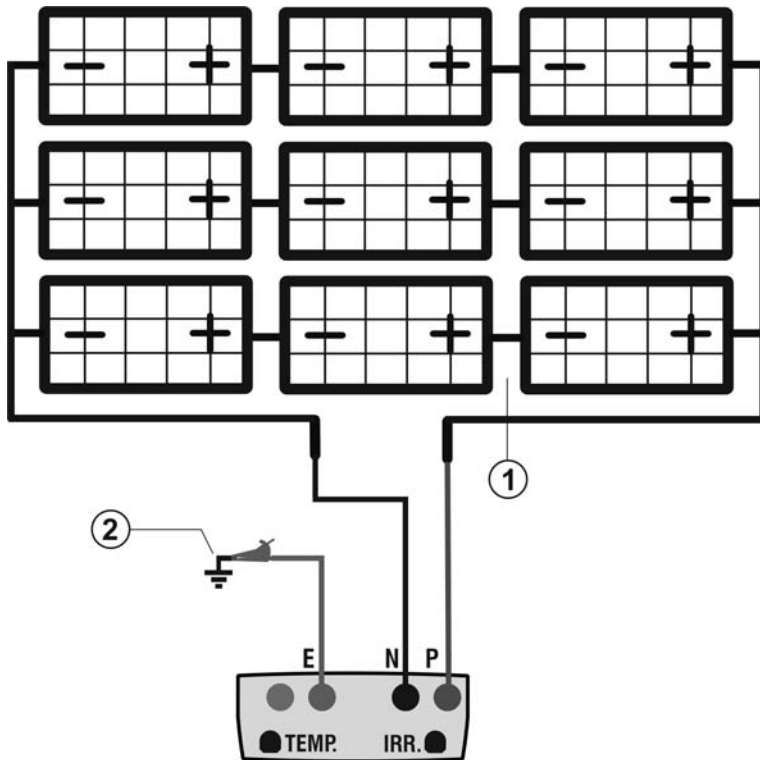
CAPTION:

- E: Green cable
 P: Red cable
 N: Black cable
1. Unearthed PV field
 2. Main system earthing

Fig. 10: Instrument connection for insulation measurement in FIELD mode

CAUTION

Upon pressing the **GO/STOP** key, different error messages can be displayed by the instrument (see § 6.6) and, therefore, the test cannot be started. Check and eliminate, if possible, the problem causing the error message before going on with the test.

4. Press **GO/STOP** to start the test. In case no error conditions occur, the instrument displays the message “Measuring...” as shown in the screen to the side.

15/05/12 15:34:26			
Ins. Test	: 1000	V	
Ri min	: 1.0	MΩ	
Mode	: Field		
Vtest	1043	1057	V
Ri(+)	- - -	MΩ	
Ri(-)	- - -	MΩ	
Rp	- - -	MΩ	
Measuring...			
Selection		MΩ	▼

5. When measurement (with a fixed duration of 10s) is complete, the instrument provides the values Ri (+) and Ri (-), respectively the insulation resistance of the Positive and Negative poles of the PV field being tested. If both results are higher than the minimum limit set, the instrument displays the message “Outcome:OK”; otherwise, it displays the message “Outcome: NO” as shown in the screen to the side.

15/05/12 15:34:26			
Test Iso	: 1000	V	
Rlim	: 1.0	MΩ	
Modo	: Campo		
Vtest	1043	1057	V
Ri (+)	> 100	MΩ	
Ri (-)	> 100	MΩ	
Rp	69	MΩ	
Outcome: OK			
		MΩ	▼

6. Press the **SAVE** key to store the test result in the instrument’s memory (see § 7.2) or the **ESC/MENU** key to exit the screen without saving and go back to the main measuring screen.

6.4.3. Measuring insulation – TIMER mode

- Position the cursor onto **MΩ** by using the arrow keys (**▲**, **▼**) and confirm with **ENTER**. The display shows the screen to the side.
- Press the **ENTER** key, activate "**Settings**" and possibly change the desired parameters (see § 5.4). The following parameters are shown on the display:
 - **Ins. Test** → selected test voltage (250, 500 or 1000VDC)
 - **Ri min** → minimum limit threshold for insulation measurement
 - **Mode** → measuring mode: TIMER
 - **Vtest** → real applied test voltage
 - **Ri (+)** → minimum insulation resistance between the Positive pole and the earthing detected during the whole duration of measurement.
 - **Test time** → test duration which can be set within a range of **10 ÷ 300s**
 - **▼** key → access to the second page with the measured values of VPN, VEP and VEN voltages

15/05/12 15:34:26		
Ins. Test	: 1000	V
Ri min	: 1.0	MΩ
Mode	: Timer	
Vtest	- - -	V
Ri(+)	- - -	MΩ
Test time:	10s	
Selection	MΩ	▼

- Connect the instrument to the possible unearthed metal masses and to the main earth node of the system (see Fig. 11)

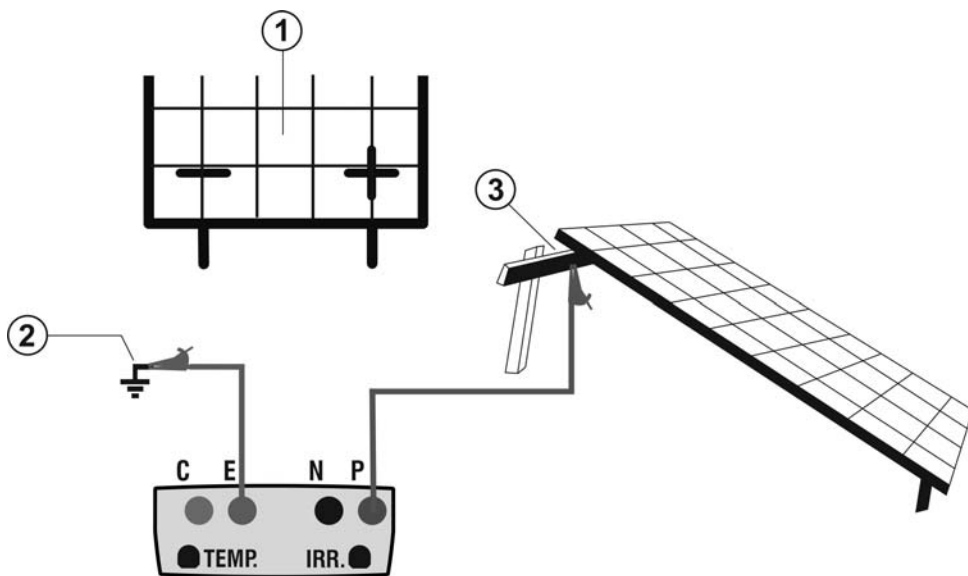

CAPTION:

E: Green cable
P: Red cable
N: Black cable

- Unearthed PV module/string
- Main system earthing
- Unearthed metal mass

Fig. 11: Instrument connection for insulation measurement in TIMER mode



CAUTION

Upon pressing the **GO/STOP** key, different error messages can be displayed by the instrument (see § 6.6) and, therefore, the test cannot be started. Check and eliminate, if possible, the problem causing the error message before going on with the test.

4. Press **GO/STOP** to start the test. In case no error conditions occur, the instrument displays the message “**Measuring...**” as shown in the screen to the side.

15/05/12 15:34:26		
Ins. Test	: 1000	V
Ri min	: 1.0	MΩ
Mode	: Timer	
Vtest	1020	V
Ri(+)min	- - -	MΩ
Test time:	10s	
Measuring...		
Selection	MΩ	▼

5. When measurement is complete, the instrument provides the Ri(+)min value, i.e. the minimum value of insulation resistance of the PV module/string (or of other metal masses) being tested, continuously measured during the whole duration of measurement. If the result is higher than the minimum limit set, the instrument displays the message “**Outcome:OK**”; otherwise, it displays the message “**Outcome:NO**” as shown in the screen to the side.

15/05/12 15:34:26		
Ins. Test	: 1000	V
Ri min	: 1.0	MΩ
Mode	: Timer	
Vtest	= 1020	V
Ri(+)min	= >200	MΩ
Test time:	200s	
Outcome: OK		
	MΩ	▼

6. Press the **SAVE** key to store the test result in the instrument’s memory (see § 7.2) or the **ESC/MENU** key to exit the screen without saving and go back to the main measuring screen.

6.4.4. Measuring insulation – STRING mode



CAUTION

The maximum current which can be measured by the instrument is 15A. Before carrying out the measures of Insulation in "STRING" mode, always ensure that the instrument is connected to **ONE STRING** and not more strings in parallel to avoid possible damage of it

- Position the cursor onto **MΩ** by using the arrow keys (**▲**, **▼**) and confirm with **ENTER**. The display shows the screen to the side.
- Press the **ENTER** key, activate "**Settings**" and possibly change the desired parameters (see § 5.4). The following parameters are shown on the display:
 - **Ins. Test** → selected test voltage (250, 500 or 1000VDC)
 - **Ri min** → minimum limit threshold for insulation measurement
 - **Mode** → measuring mode: STRING
 - **Vtest** → real applied test voltage
 - **Rp** → final value of the measurement obtained by the parallel of Ri(+) e Ri(-) values which is compared with the Ri min limit by the instrument
 - **▼** key → access to the second page with the measured values of VPN, VEP and VEN voltages
- Connect the instrument to the PV module/string being tested and to the main earth node of the system as shown in . In particular, connect the negative output pole of the PV field to terminal N and the positive output pole of the PV field to terminal P.

15/05/12 15:34:26	
Ins. Test	: 1000 V
Ri min	: 1.0 MΩ
Mode	: String
Vtest	- - - V
Rp	- - - MΩ
Selection	MΩ ▼

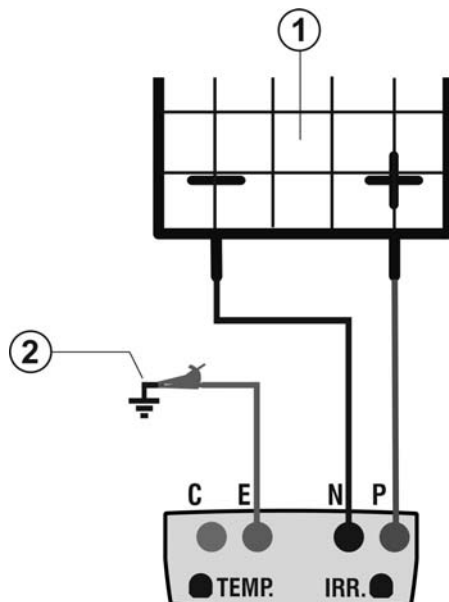

CAPTION:

E: Green cable
P: Red cable
N: Black cable

1. Unearthed PV module/string
2. Main system earthing

Fig. 12: Instrument connection for insulation measurement in STRING mode



CAUTION

Upon pressing the **GO/STOP** key, different error messages can be displayed by the instrument (see § 6.6) and, therefore, the test cannot be started. Check and eliminate, if possible, the problem causing the error message before going on with the test.

4. Press **GO/STOP** to start the test. In case no error conditions occur, the instrument displays the message “**Measuring...**” as shown in the screen to the side.

15/05/12 15:34:26		
Ins. Test	: 1000	V
Ri min	: 1.0	MΩ
Mode	: Stringa	
Vtest	= 1020	V
Rp	= - - -	MΩ
Measuring...		
Selection		MΩ

5. When measurement is complete, the instrument provides the Ri value, i.e. the minimum value of insulation resistance of the of other objects being tested, continuously measured during the whole duration of measurement. If the result is higher than the minimum limit set, the instrument displays the message “**Outcome:OK**”; otherwise, it displays the message “**Outcome:NO**” as shown in the screen to the side.

15/05/12 15:34:26		
Ins. Test	: 1000	V
Ri min	: 1.0	MΩ
Mode	: Stringa	
Vtest	= 1020	V
Rp	= >100	MΩ
Outcome: OK		
		MΩ

6. Press the **SAVE** key to store the test result in the instrument’s memory (see § 7.2) or the **ESC/MENU** key to exit the screen without saving and go back to the main measuring screen.

6.4.4.1. Anomalous situations

1. In any operating mode, in case the instrument detects a voltage higher than 1000V at terminals P-N, P-E and N-E, it does not carry out the test, gives out a long sound and displays the message “Vin > 1000”.

15/05/12 15:34:26		
Ins. Test	: 1000	V
Ri min	: 1.0	MΩ
Mode	: String	
Vtest	= - - -	V
Rp	= - - -	MΩ
Vin > 1000		
Selection		MΩ

2. In STRING mode, in case the instrument detects an Isc current higher than 15A, it does not carry out the test, gives out a long sound and displays the message “Isc current too high”.

15/05/12 15:34:26		
Ins. Test	: 1000	V
Ri min	: 1.0	MΩ
Mode	: Stringa	
Vtest	= - - -	V
Rp	= - - -	MΩ
Isc current too high		
Selection		MΩ

3. In STRING mode, in case the instrument detects a current < 0.2A between terminals P and N, it does not carry out the test, gives out a long sound and displays the message “Current < Lim”.

15/05/12 15:34:26		
Ins. Test	: 1000	V
Ri min	: 1.0	MΩ
Mode	: String	
Vtest	= - - -	V
Rp	= - - -	MΩ
Current < Lim		
Selection		MΩ

4. In STRING mode, in case the instrument detects a voltage < 15V between terminals P and N, it does not carry out the test and displays the message “Low voltage”.

15/05/12 15:34:26		
Ins. Test	: 1000	V
Ri min	: 1.0	MΩ
Mode	: String	
Vtest	= - - -	V
Rp	= - - -	MΩ
Low voltage		
Selection		MΩ

6.5. MEASUREMENT OF CONTINUITY ON PV MODULES/STRINGS/FIELDS (LOW Ω)

6.5.1. Foreword

The purpose of this measurement is to test the continuity of protective conductors and equipotential ones (e.g. from rod to earth and connected foreign earth) and earth rods of SPDs on PV installations. The test must be carried out using a test current $> 200\text{mA}$ according to the prescriptions of IEC/EN62446 guideline

6.5.2. Calibration of measuring cables

- Position the cursor onto **LOW Ω** by using the arrow keys (\blacktriangle , \blacktriangledown) and confirm with **ENTER**. The display shows the screen to the side.

Fig. 13: Compensation of the measuring cables' resistance
Connect the measuring cables as shown in Fig. 13:
Compensation of the measuring cables' resistance

2.

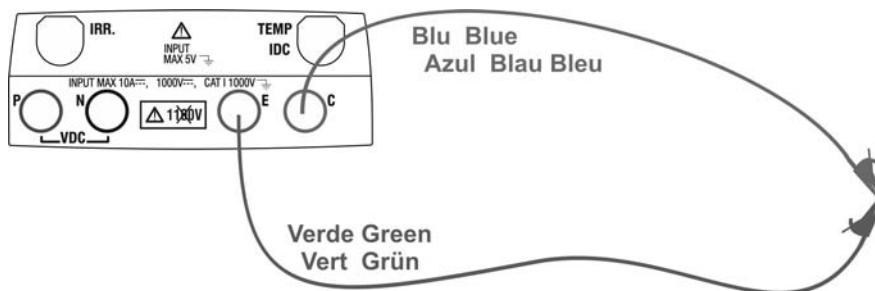

Fig. 13: Compensation of the measuring cables' resistance

- Press the **ENTER** key. The instrument shows the following options: **Settings** and **Leads calibration**
- Use the arrow keys (\blacktriangle , \blacktriangledown) to select "**Leads calibration**" and confirm with **ENTER**.

15/05/12 15:34:26	
Rpe max	: 1 Ω
Rcal	: - - - Ω
Rpe	= - - - Ω
Itest	= - - - mA
Leads calibration	
Settings	
Selection LOWΩ	

- Press **GO/STOP** to start calibration. The message "Measuring..." is shown on the display.
- At the end of the compensation procedure, in case the measured value of resistance is lower than 5Ω , the instrument gives out a double sound to signal the positive result of the test. The following screen appears on the display:

15/05/12 15:34:26	
RPE max	: 1 Ω
Rcal	: - - - Ω
Rpe	= - - - Ω
Itest	= - - - mA
Measuring...	
Selection LOWΩ	

6. The value of compensated resistance of the cables which will be subtracted from all subsequent continuity measures is shown next to “Rcal” and the message “Calibration OK” appears on the display.
7. To delete the value of compensated resistance, carry out a new compensation procedure with a resistance higher than 5Ω such as, for example, with open leads. The value in Rcal is zeroed on the display.

15/05/12 15:34:26	
RPE max	: 1.0 Ω
Rcal	: 0.02 Ω
Rpe	= - - - Ω
Itest	= - - - mA
Calibration OK	
Selection	LOW Ω

6.5.3. Measuring continuity

1. Position the cursor onto **LOW Ω** by using the arrow keys (**▲**, **▼**) and confirm with **ENTER**. The display shows the screen to the side.
2. Press the **ENTER** key, activate “**Settings**” and possibly change the desired parameters (see § 5.3.1). The following parameters are shown on the display:
 - **RPE max** → maximum threshold for continuity measurement, which can be selected in a range $1\Omega \div 5\Omega$ in steps of 1Ω
 - **Rcal** → the value of resistance of the measuring cables after calibrating them
 - **Rpe** → the result of continuity measurement
 - **Itest** → real test current
3. Press the **ENTER** key, activate “**Cable calibration**” (see § 6.5.2) to carry out the initial calibration of the measuring cables.

15/05/12 15:34:26	
RPE max	: 1.0 Ω
Rcal	: - - - Ω
Rpe	= - - - Ω
Itest	= - - - mA
Selection	LOW Ω

Connect the instrument to the PV module/string being tested and to the main earth node of the system as shown in

4. Fig. 14

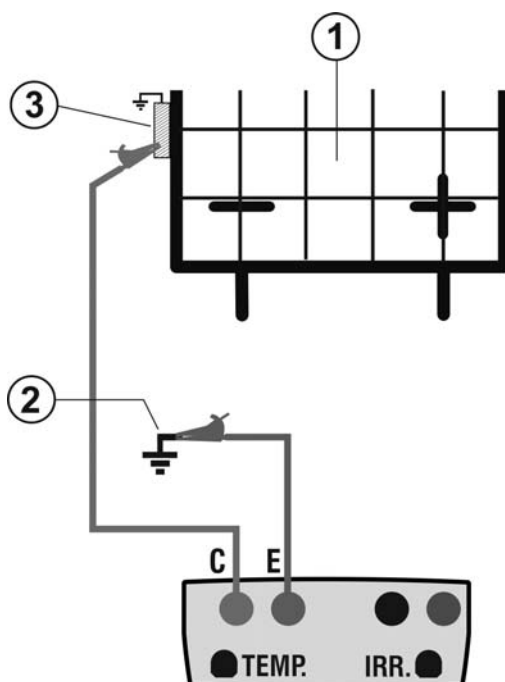

CAPTION:

E: Green cable
C: Blue cable

1. PV module/string
2. Main system earthing
3. Earthed metal structure in the system

Fig. 14: Connection for continuity measurement on structures of the PV installation

CAUTION

Upon pressing the **GO/STOP** key, different error messages can be displayed by the instrument (see § 6.6) and, therefore, the test cannot be started. Check and eliminate, if possible, the problem causing the error message before going on with the test.

5. Press **GO/STOP** to start the test. In case no error conditions occur, the instrument displays the message “**Measuring...**” as shown in the screen to the side.

15/05/12 15:34:26		
RPE max	:	1.0 Ω
Rcal	:	- - - Ω
Rpe	=	- - - Ω
Itest	=	- - - mA
Measuring...		
Selection		LOWΩ

6. At the end of measurement, the instrument provides the value of resistance of the object being tested. If the result is lower than the maximum limit set, the instrument displays the message “**Outcome:OK**”; otherwise, it displays the message “**Outcome:NO**” as shown in the screen to the side.

7. Press the **SAVE** key to store the test result in the instrument’s memory (see § 7.2) or the **ESC/MENU** key to exit the screen without saving and go back to the main measuring screen.

15/05/12 15:34:26		
Rpe max	:	1.0 Ω
Rcal	:	- - - Ω
Rpe	=	0.23 Ω
Itest	=	210 mA
Outcome: OK		
Selection		LOWΩ

6.5.3.1. Anomalous situations

1. In case the instrument detects a voltage higher than 5V at its terminals E and C, it does not carry out the test, gives out a long sound and displays the message "Voltage > Lim".

15/05/12 15:34:26		
RPE max	:	1 Ω
Rcal	:	- - - Ω
Rpe	=	- - - Ω
Itest	=	- - - mA
Voltage > Lim		
Selection		LOWΩ

2. In case the instrument detects that the calibrated resistance is higher than the measured resistance, the instrument gives out a long sound and displays the message: "Calibration not OK"

15/05/12 15:34:26		
RPE max	:	1 Ω
Rcal	:	- - - Ω
Rpe	=	- - - Ω
Itest	=	- - - mA
Calibration not OK		
Selection		LOWΩ

3. In case the instrument detects a resistance higher than 5Ω at its terminals, it gives out a long sound, zeroes the compensated value and displays the message "Calibration reset".

15/05/12 15:34:26		
RPE max	:	1 Ω
Rcal	:	0.00 Ω
Rpe	=	- - - Ω
Itest	=	- - - mA
Calibration reset		
Selection		LOWΩ

6.6. LIST OF DISPLAY MESSAGES

MESSAGE	DESCRIPTION
Function not available	The selected function/characteristic is not available
Data not saved	The instrument was not able to save the data
Wrong date	Set a correct system date
RADIO transmission error	The instrument does not communicate via RF with external units
SOLAR-02: Firmware incorrect	Inconsistent SOLAR-02 FW. Update firmware.
Firmware incorrect	Unsuitable instrument FW. Update firmware.
Error 4: contact service	Internal instrument error
Database full	The number of modules added to the internal DB is > 30
Module already added	The name of the module has already been added to the DB
Memory full	Instrument memory full upon pressing the GO key
Error: Vmpp >= Voc	Check module settings inside DB
Error: Impp >= Isc	Check module settings inside DB
Error: Vmpp * Impp >= Pmax	Check module settings inside DB
Error: Alpha too high	Check module settings inside DB
Error: Beta too high	Check module settings inside DB
Error: Gamma too high	Check module settings inside DB
Error: Toll too high	Check module settings inside DB
Wait data analysis	Download data from SOLAR-02 and wait for the result of PV efficiency test
Download error	Contact service department
Error while saving	Problems with the access to memory area
Remote unit undetected	The instrument does not detect any remote unit SOLAR-02
Unable to perform analysis	Problems with the data downloaded from SOLAR-02. Check settings.
Data unavailable	Generic error. Repeat the test.
Negative voltage	Check the polarity of the instrument's input terminals
Low voltage	Check the voltage between input terminals P and N
Vin > 1000	Voltage between input terminals > 1000V
Wrong no. of modules. Continue?	Set no. of modules inconsistent with measured Voc
Ref. cell temp. exceeding limits	Temperature measured by reference cell too high
Cell temp. undetected (ENTER/ESC)	Measurement not carried out on module cell
Low battery	Low battery charge. Insert new batteries.
Please wait for cooling...	Instrument overheated. Wait before resuming the test.
Irradiance too low	Irradiance value lower than the minimum threshold set
NTC Error	Internal NTC efficiency jeopardized. Contact service department
Isc current too high	Measured Isc current > 15A
Current < Lim	Current between P and N lower than the minimum detectable value
EEPROM error: contact service	Internal instrument error
FRAM error: contact service	Internal instrument error
RTC Error: contact service	Internal instrument error
RADIO error: contact service	Internal instrument error
FLASH error: contact service	Internal instrument error
IO EXP error: contact service	Internal instrument error
Voltage > limit	Voltage between terminals E and C > 10V
Label already assigned	Change the numeric reference of the marker associated with the measurement
Isc current < Lim	Isc current lower than the minimum detectable value. Contact service department
CAUTION: internal short-circuit	Contact service department
CAUTION: blown fuse	Contact service department
Reset calibration. Press ENTER.	Resistance value of input cables > 2Ω
Calibration not OK	Calibrated resistance value > measured resistance
Error: Isc offset measurement	Internal instrument error
Rcal > measured R	Calibrated resistance value > measured resistance
CAUTION: AC voltage at P-N terminals	Presence of AC input voltage
Wait for condenser discharge	Wait for discharge of tested object after insulation

7. STORING DATA

The instrument allows saving max 999 measured values. The saved data can be recalled at display and deleted at any moment, and can be associated to reference numerical markers relevant to the installation name, the PV string and the PV module (max 250 markers).

7.1. SAVING EFFICIENCY MEASURES

1. Press the **SAVE** key with a measured result shown on the display. The instrument shows the screen to the side, containing a virtual keyboard.
2. Use the arrow keys (**▲,▼**) and (**◀, ▶**) to add a short description (max 13 chars) relevant to the test performed.
3. Press the **SAVE** key again to confirm data saving or **ESC/MENU** to exit without saving.

15/05/12 15:34:26																
Irr	712	W/m ²														
Pnom	3.500	kW														
Tc	45	°C														
Te	30	°C														
Pdc	3.125	kW														
KEYBOARD																
PV PLANT																
A	B	C	D	E	F	G	H	I	J	K	L	M	N	O	P	
Q	R	S	T	U	V	W	X	Y	Z	-	+	0	1	2	3	
4	5	6	7	8	9	SPACE										DEL
SAVE/ESC																

7.2. SAVING IVCK, MΩ AND LOWΩ MEASURED RESULTS

1. Press the **SAVE** key with a measured result shown on the display. The instrument shows the screen to the side, containing the following items:
 - The first memory location available ("MEASURE")
 - The 1st marker level (ex: Area)
 - The 2nd marker level (ex: Field)
 - The 3rd marker level (ex: Inverter)
 - The field "Comment" in which the operator can include a short description (max 13 char) for the system.

15/05/12 15:34:26		
MEASURE	:	004
Area	:	◀ 001 ▶
Field	:	001
Inverter	:	001
Comment	:	
Modification		SAVE

2. Each marker level can be assigned to different labels (5 labels are built-in and 5 labels can be customized). Select the desired marker level using the arrow keys (**◀, ▶**) and press the **ENTER** key to get available strings.
3. Select one of the items available using the arrow keys (**▲,▼**) and confirm with **ENTER**.

Inverter		
Area		004
Building		◀ 002 ▶
Field		001
Plant		001
Comment	:	
Modification		SAVE

4. Before performing a test, by mean Topview PC software, it's possible to add custom strings into the list of marker level strings. In this case, the new values may be selected as an alternative to the built-in ones, as shown in the screen to the side.

Solar Power		
PVPlant factory		004
HT instruments		◀ 002 ▶
HT ITALIA		001
PV installation		001
Inverter		
Area		
Building		
Field		
Plant		
Modification		SAVE

CAUTION



- Marker strings can be uploaded into the instrument **by mean of the TopView software** through a PC connection (“Marker manager”).
- It is possible to add up to 5 custom strings for each marker, further to the 5 provided as default values.
- Deletion of custom strings can only occur **through the TopView software**. (The built-in strings cannot be eliminated.)

5. Use the arrow keys (▲,▼) and (◀, ▶) with the virtual keyboard to add a short description (max 13 chars) in the “Comment” field. Press **ENTER** to digit any character of the desired name.

15/05/12 15:34:26															
MEASURE	:	004													
HT ITALIA	:	◀ 002 ▶													
String1	:	001													
Module1	:	001													
Comment	:														
TASTIERA															
TEST IMP. HT															
A	B	C	D	E	F	G	H	I	J	K	L	M	N	O	P
Q	R	S	T	U	V	W	X	Y	Z	-	+	0	1	2	3
4	5	6	7	8	9	SPACE									DEL
SAVE/ESC															

6. Press the **SAVE** key again to confirm data saving or **ESC/MENU** to exit without saving.

7.3. OPERATIONS WITH RESULTS

7.3.1. Recalling on the display the PV efficiency results

- Press the **ESC/MENU** key to go back to the main menu, select **"MEM"** and confirm with **ENTER** to access the section where saved values are displayed. The screen to the side is shown by the instrument and contains the saved tests.
- Using the arrow keys (**▲, ▼**) and the arrow key **▶**, select **"Recall"**, then **"Efficiency"** and confirm with **ENTER** to display the results of test only.
- Using the arrow key **▶** it is possible to display the following labels:
 - **TYPE** → indicates the type of data saved: **"REC"** for a check with a precise final result YES/NO, **"*REC"** when the instrument does not have the irradiance and temperature values recorded by SOLAR-02 and **"IST"** for saving the instant conditions on the display.
 - **DATE** → indicates the date and time in which the datum has been saved in the instrument.
 - **DESCRIPTION** → indicates the description provided by the user when saving the datum.
- Select the type of **"SMP"** datum, the item **"Open"** and confirm with **ENTER**. The instrument shows the following screen
- Select the type of **"REC"** datum, the item **"Open"** and confirm with **ENTER**. The instrument shows the screen containing the final results.
- Selecting the **"*REC"** datum type, the item **"View"** and confirming with **ENTER**, the message "Unable to perform analysis" is displayed due to the irradiance/temperature values recorded by SOLAR-02 missing. **The partial values of this measurement are only visible after downloading the data onto the PC (see § 8) using TopView.**

15/05/12 15:34:26	
MEM	TYPE
001	SMP 08/04/2012
002	REC 13/05/2012
003	*REC 14/05/2012
Efficiency	
Rec	IVCK, MΩ, LOWΩ
Open	
Delete	▶
Selection	MEM - EFF

15/05/12 15:35:00		
Irr	712	W/m ²
Pnom	3.500	kW
Tc	45	°C
Te	30	°C
Pdc	3.125	kW
Vdc	389	V
Idc	8.01	A
ndc	0.88	
Analysis Results		
Selection	EFF	

7.3.2. Recalling on the display the results of IVCK, MΩ and LOWΩ measurements

1. Press the **ESC/MENU** key to go back to the main menu, select "**MEM**" and confirm with **ENTER** to access the section where saved values are displayed. The screen to the side is shown by the instrument and contains the saved tests.
2. Using the arrow keys (**▲**, **▼**) and the arrow key **▶**, select "**Recall**", then "**IVCK**" and confirm with **ENTER** to display the results of the I-V curve only.
3. The field "**DATE**" indicates the date/time in which the result of measurement has been saved, the field "**TYPE**" indicates the type of test carried out (LOWΩ, MΩ, IVCK).
4. Use the arrow key **▶** to go to the "**Comments**" label
5. The instrument will display the comment inserted by the operator during the saving procedure (see § 7.2) as regards the system.
6. The symbol "*" next to the measurement number indicates that the instrument has performed the tests with recording of irradiance and temperature values through the remote unit, but these values have not been transferred or are not available. **For these measurements, the values translated to STC will not be available.**
7. Press **ESC/MENU** to exit the screen and go back to the main menu.

15/05/12 15:34:26		
MEM	DATE	TYPE
001	08/04/2012 10:38	LOWΩ
002	13/04/2012 12:15	MΩ
003	15/05/12 12:20	IVCK
Efficiency		
Rec IVCK, MΩ, LOWΩ		
Open		
Delete ▶		
Selection		MEM- IVCK

15/06/12 15:34:26	
MEM	Comments
001	PV PLANT 1
002*	PV PLANT 2
Selection	
MEM- IVCK	

7.3.2.1. Accessing the data saved in the memory – Numeric display

1. Select a line corresponding to a saved result and press **ENTER**.

2. Select "Open" and press **ENTER** to open the section where measurement results are displayed as:

- Numeric screens of measured parameters under standard (STC) conditions and under operating (OPC) conditions for IVCK tests
- Numeric screens of measured parameters when measuring insulation ($M\Omega$) and continuity ($LOW\Omega$).

15/05/12 15:34:26	
MEM	Comments
001	PV PLANT 1
002*	PV PLANT 2
Open Recall ▶ Delete ▶	
Selection	MEM-IVCK

3. For **IVCK** test, there are the values of the following parameters:

- The module being used
- The value of irradiance
- The value of temperature of the module
- The average values of Voc and Isc under OPC conditions
- The values of Voc and Isc measured under OPC conditions
- The values of Voc and Isc calculated under STC and the relevant partial results obtained by comparison with the nominal values.

15/05/12 15:34:26	
Module:	SUNPWR210 ▲
Irr	903W/m ²
Tc (AUTO)	57°C
VocAvg@OPC	- - -V
IscAvg@OPC	- - -A
Voc@OPC	647V
Isc@OPC	5.35A
Voc@STC	787V OK
Isc@STC	5.72A OK
Outcome: OK	
Selection	IVCK

4. For **$M\Omega$** test in FIELD mode there are the values of the following parameters:

- Set rated test voltage
- Minimum threshold set on insulation measurement
- The type of mode-selected
- The real value of the applied test voltage
- The insulation value of positive pole Ri (+)
- The insulation value of positive pole Ri (-)

15/05/12 15:34:26	
Ins. Test	: 1000 V
Ri min	: 1.0 $M\Omega$
Mode	: Field
Vtest	1065 1064 V
Ri (+)	>100 $M\Omega$
Ri (-)	>100 $M\Omega$
Rp	72 $M\Omega$
Outcome: OK	
Selection	$M\Omega$ ▼

5. For **$M\Omega$** test in TIMER mode there are the values of the following parameters:

- Set rated test voltage
- Minimum threshold set on insulation measurement
- The type of selected mode
- The real value of the applied test voltage
- The Ri(+) minimum value of insulation resistance of the PV module/string (or of other metal masses) being tested, continuously measured during the whole duration of measurement.
- The set measuring time

15/05/12 15:34:26	
Ins. Test	: 1000 V
Ri min	: 1.0 $M\Omega$
Mode	: Timer
Vtest	1020 V
Ri(+)min	>200 $M\Omega$
Test time:	10s
Outcome: OK	
Selection	$M\Omega$ ▼

6. For **MΩ** test in STRING mode there are the values of the following parameters:

- Set rated test voltage
- Minimum threshold set on insulation measurement
- The type of mode selected
- The real value of the applied test voltage
- The Rp final value of the measurement obtained by the parallel of Ri(+) e Ri(-) values which is compared with the Ri min limit by the instrument

15/05/12 15:34:26		
Ins. Test	: 1000	V
Ri min	: 1.0	MΩ
Mode	: String	
Vtest	1020	V
Rp	>200	MΩ
Outcome: OK		
Selection	MΩ	

7. For **LOWΩ** test, there are the values of the following parameters:

- Limit threshold set for continuity measurement
- Value of calibration resistance of test cables
- The value of resistance of the object being tested
- The real value of the applied test current

15/05/12 15:34:26		
RPE max	: 1.0	Ω
Rcal	: - - -	Ω
Rpe	= 0.99	Ω
Itest	= 212.	mA
Outcome: OK		
Selection	LOWΩ	

7.3.3. Deleting data from the memory

1. Within the list of saved results, press **ENTER** to display the submenus.
2. Select "Delete", then press **▶**. The instrument allows selecting the following items:
 - **Delete Last** → deletes the last saved test
 - **Delete All** → deletes the whole memory content
3. Use the arrow keys (**▲**, **▼**) to select the desired option, then press the **ENTER** key to confirm selection
4. Press **ESC/MENU** to exit the screen and go back to the main menu.

15/05/12 15:34:26		
MEM	TYPE	
001	SMP	08/04/2012
002	REC	13/04/2012
Recall ▶		
Open	Delete Last	
Delete	Delete All	
Selection	MEM EFF	

8. CONNECTING THE INSTRUMENT TO THE PC

CAUTION



- The connection between instrument and PC is realized by means of cable C2006.
- In order to transfer the data onto a PC it is necessary to install beforehand both the management software Topview and the drivers of cable C2006 on the PC itself.
- Before connecting, it is necessary to select the port to be used and the correct baud rate (57600 bps) on the PC. To set these parameters, launch the **TopView** software provided and refer to the programme's on-line help.
- The selected port must not be engaged by other devices or applications, e.g. a mouse, a modem, etc. Close any applications running using the Microsoft Windows Task Manager function.
- The optical port emits invisible LED radiations. Do not directly observe with optical instruments. Class 1M LED apparatus according to standard IEC/EN 60825-1.

To transfer data to the PC, follow this procedure:

1. Switch on the instrument by pressing the **ON/OFF** key.
2. Connect the instrument to the PC via the provided optical/USB cable **C2006**.
3. Press the **ESC/MENU** key to open the main menu.
4. Use the arrow keys (**▲**, **▼**) to select "**PC**" to access data transfer mode and confirm with **ENTER**.

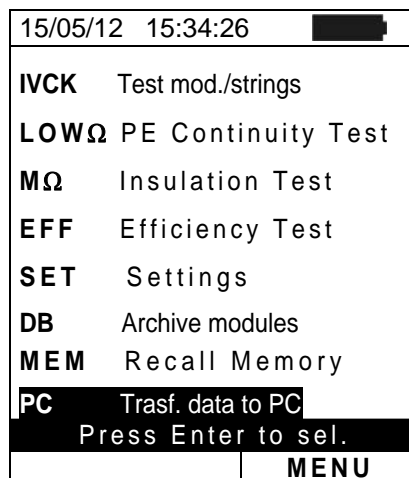

5. The instrument shows the following screen:

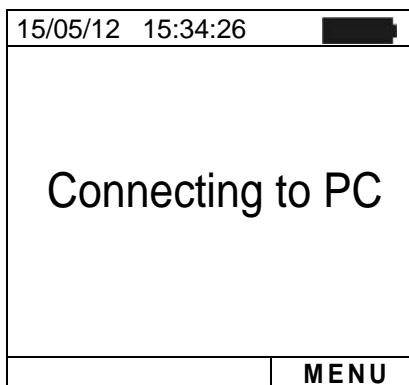

6. Use TopView controls to activate data transfer (please refer to the on-line help of the programme)

9. MAINTENANCE

9.1. GENERAL INFORMATION

The instrument you purchased is a precision instrument. While using and storing the instrument, carefully observe the recommendations listed in this manual in order to prevent possible damage or danger during use.

Do not use the instrument in environments with high humidity levels or high temperatures. Do not expose to direct sunlight.

Always switch off the instrument after use. In case the instrument is not to be used for a long time, remove the batteries to avoid liquid leaks that could damage the instrument's internal circuits.

9.2. BATTERY REPLACEMENT

When the low battery symbol "" appears on the LCD display, or if during a test the instrument shows the message "low battery", it is necessary to replace the batteries.



CAUTION

Only expert and trained technicians should perform this operation. Before carrying out this operation, make sure you have disconnected all cables from the input terminals.

1. Switch off the instrument by pressing and holding the ON/OFF key.
2. Remove the cables from the input leads.
3. Loosen the battery compartment cover fastening screw and remove the cover.
4. Remove all the batteries from the battery compartment and replace them only with new batteries of the same type only (see § 10.5) making sure to respect the indicated polarities.
5. Restore the battery compartment cover into place and fasten it by means of the relevant screw.
6. Do not scatter old batteries into the environment. Use the relevant containers for disposal.

9.3. CLEANING THE INSTRUMENT

Use a soft and dry cloth to clean the instrument. Never use wet cloths, solvents, water, etc.

9.4. END OF LIFE



CAUTION: this symbol indicates that the appliance, its accessories and the internal batteries must be collected separately and correctly disposed of.

10. TECHNICAL SPECIFICATIONS

10.1. TECHNICAL SPECIFICATIONS FOR PV INSTALLATION EFFICIENCY

Accuracy is indicated as [%reading + (no. of digits) * resolution] at 23°C ± 5°C, <80%HR

DC voltage

Range [V]	Resolution [V]	Accuracy
5.0 ÷ 199.9	0.1	±(1.0%rdg + 2dgt)
200.0 ÷ 999.9	0.5	

DC current (by means of external clamp transducer)

Range [mV]	Resolution [mV]	Accuracy
-1100 ÷ -5	0.1	±(0.5%rdg + 0.6mV)
5 ÷ 1100		

The value of current is ALWAYS displayed with a positive sign: the value of current transduced in a voltage lower than 5mV is zeroed.

FS DC clamp [A]	Resolution [A]	Minimum read value [A]
1 < FS ≤ 10	0.001	0.05
10 < FS ≤ 100	0.01	0.5
100 < FS ≤ 1000	0.1	5

DC power (V_{mis} > 150V)

Clamp FS [A]	Range [W]	Resolution [W]	Accuracy
1 < FS ≤ 10	0.000k ÷ 9.999k	0.001k	±(1.5%rdg + 3dgt) (I _{mis} < 10%FS) ±(1.5%rdg) (I _{mis} ≥ 10%FS)
10 < FS ≤ 100	0.00k ÷ 99.99k	0.01k	
100 < FS ≤ 1000	0.0k ÷ 999.9k	0.1k	

V_{mis} = voltage at which power is measured; I_{mis} = measured current

Irradiance (with HT304N reference cell)

Range [mV]	Resolution [mV]	Accuracy
1 ÷ 40.0	0.02	±(1.0%rdg + 0.1mV)

Temperature (with probe type PT300N)

Range [°C]	Resolution [°C]	Accuracy
-20.0 ÷ 100.0	0.1	±(1.0%rdg + 1°C)

10.2. TECHNICAL SPECIFICATIONS OF THE IVCK FUNCTION

DC Voltage @ OPC

Range [V]	Resolution [V]	Accuracy
5.0 ÷ 199.9	0.1	±(1.0%rdg + 2dgt)
200 ÷ 999	0.5	

Minimum VPN voltage to start the test: 15V

DC Current @ OPC

Range [A]	Resolution [A]	Accuracy
0.10 ÷ 15.00	0.01	±(1.0%rdg + 2dgt)

DC Voltage @ STC

Range [V]	Resolution [V]	Accuracy
5.0 ÷ 199.9	0.1	±(4.0%rdg + 2dgt)
200 ÷ 999	1	

DC Current @ STC

Range [A]	Resolution [A]	Accuracy
0.10 ÷ 15.00	0.01	±(4.0%rdg + 2dgt)

Irradiance (with HT304N reference cell)

Range [mV]	Resolution [mV]	Accuracy
1 ÷ 40.0	0.02	±(1.0%rdg + 0.1mV)

Temperature (with probe type PT300N)

Range [°C]	Resolution [°C]	Accuracy
-20.0 ÷ 100.0	0.1	±(1.0%rdg + 1°C)

10.3. TECHNICAL SPECIFICATIONS FOR ELECTRICAL SAFETY

Continuity of protective conductors (LOWΩ)

Range [Ω]	Resolution [Ω]	Accuracy
0.00 ÷ 1.99	0.01	±(2.0%rdg + 2dgt)
2.0 ÷ 19.9	0.1	
20 ÷ 199	1	

Test current >200mA DC up to 5Ω (cables included), resolution 1mA, accuracy ±(5.0%reading + 5digits)

Open-circuit voltage $4 < V_0 < 10V$

Insulation resistance (MΩ) – Mode TIMER

Test voltage [V]	Range [MΩ]	Resolution [MΩ]	Accuracy
250, 500, 1000	0.01 ÷ 1.99	0.01	±(5.0%rdg + 5dgt)
	2.0 ÷ 19.9	0.1	
	20 ÷ 199	1	

Open voltage <1.25 x nominal test voltage

Short circuit current < 15mA (peak) for each test voltage

Generated voltage resolution 1V, accuracy ±(5.0%reading + 5digits) @ Rmis > 0.5% FS

Rated current measured > 1mA with 1kΩ @ Vnom

Insulation resistance (MΩ) – Mode FIELD (*), STRING (**)

Test voltage [V]	Range [MΩ]	Resolution [MΩ]	Accuracy (***)
250, 500, 1000	0.1 ÷ 1.9	0.1	±(20.0%rdg + 5dgt)
	2 ÷ 99	1	

(*) For FIELD mode

(**) For STRING mode

Open voltage

Short circuit current

Generated voltage

Rated current measured

if VPN >1V the minimum voltage VEP and VEN for the calculation of Ri(+) and Ri(-) is 1V

minimum VPN voltage to start the test: 15V

<1.25 x nominal test voltage

< 15mA (peak) for each test voltage

resolution 1V, accuracy ±(5.0%reading + 5digits) @ Rmis > 0.5% FS

> 1mA with 1kΩ @ Vnom

(***) For FIELD mode:

add 5 dgts to the accuracy if
$$\frac{\max\{R^+, R^-\}}{\min\{R^+, R^-\}} \geq 100$$

10.4. REFERENCE STANDARDS

10.4.1. General

Instrument safety:	IEC/EN61010-1
EMC:	IEC/EN61326-1
Safety of measuring accessories:	IEC/EN61010-031
Measurements:	IEC/EN62446 (IVCK, LOW Ω , M Ω)
Insulation:	double insulation
Pollution level:	2
Measurement category:	CAT III 300V to earth Max 1000V between inputs P, N, E, C

10.5. GENERAL CHARACTERISTICS

Display and memory

Type of display:	LCD custom, 128x128 pxl, with backlighting
Saved data:	max 999
PC interface:	optical / USB

Characteristics of radio module

Frequency range:	2.400 ÷ 2.4835GHz
R&TTE category:	Class 1
Max transmission power:	30 μ W
Max RF connection distance:	1m

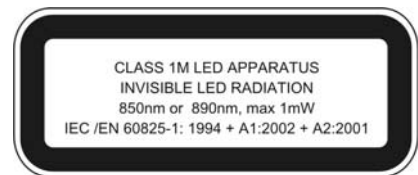

PV system efficiency

Integration Period:	5,10,30,60,120,300,600,900,1800,3600s
Memory of SOLAR-02:	approx. 1.5 hours (@ PI = 5s) approx. 8 days (@ PI = 600s)

Power supply

Battery type:	6x1.5V alkaline type AA LR06 MN1500
Low battery indication:	the display shows symbol " 
Battery life:	approx 120 hours (PV efficiency)
Automatic power off:	after 5 minutes

Mechanical characteristics

Size (L x W x H):	235 x 165 x 75mm (9 x 6 x 3in)
Weight (batteries included):	1.2kg (2.5lv)

10.6. ENVIRONMENTAL CONDITIONS FOR USE

Reference temperature:	23° ± 5°C (73° ± 41°F)
Operating temperature:	0 ÷ 40°C (32 ÷ 104°F)
Allowable relative humidity:	<80%HR
Storage temperature:	-10 ÷ 60°C (14 ÷ 140°F)
Storage humidity:	<80%HR
Max operating altitude:	2000m

This instrument satisfies the requirements of Low Voltage Directive 2014/35/EU (LVD) and of EMC Directive 2014/30/EU

This instrument satisfies the requirements of 2011/65/EU (RoHS) directive and 2012/19/EU (WEEE) directive

10.7. ACCESSORIES

See the attached packing list

11. APPENDIX – THEORETICAL OUTLINE

11.1. EFFICIENCY TEST ON PV INSTALLATIONS

According to the requirements of the laws in force, DC efficiency test on a PV installation depends on the type of correction used to compensate the effects of the module's temperature and on the mathematical relationship used to calculate the **nDC** parameter (see § 5.2.3).

Corr.	Tcel value	Mathematical relationship for nDC calculation	Standard	Result
Tmod	Tcel = Measured module temp. value	$Rfv2 = \begin{cases} 1 & (\text{se } T_{cel} \leq 40^{\circ}\text{C}) \\ 1 - (T_{cel} - 40) \times \frac{ \gamma }{100} & (\text{se } T_{cel} > 40^{\circ}\text{C}) \end{cases}$ hence $nDC = \frac{P_{dc}}{\left[Rfv2 \times \frac{G_p}{G_{STC}} \times P_n \right]}$	Italian guideline CEI 82-25	OK/NO
Tenv	Tcel = Calculated module temp. value $T_{cel} = T_{amb} + (NOCT - 20) \times \frac{G_p}{800}$			
nDC	Tcel = Measured module temp. value	$nDC = \frac{G_{STC}}{G_p} \times \left[1 + \frac{ \gamma }{100} \times (T_{cel} - 25) \right] \times \frac{P_{dc}}{P_n}$

where:

Symbol	Description	Measuring unit
G_p	Irradiance measured on PV module surface	[W/m ²]
G_{STC}	Standard Irradiance = 1000	[W/m ²]
P_n	Rated Power = sum of all Pmax values of the section of the PV plant being measured	[kW]
P_{dc}	DC power measured at the PV generator's output	[kW]
$Rfv2$	Correction factor depending on the Temperature of PV Cells (Tcel) measured or calculated according to the type of selected correction relationship	
$ \gamma $	Absolute value of the thermal coefficient of Pmax of the PV modules included in the plant section being measured.	[%/°C]
NOCT	(Normal Operating Cell Temperature) = Temperature the cells under reference conditions are brought to (800W/m ² , 20°C, AM=1.5, air speed =1m/s).	[%/°C]

The previous relationships are valid if **Irradiance > Min Irradiance** (see the User Manual of the MASTER instrument) and the irradiance values are “**steady**”, i.e. for each sample taken, **with IP ≤ 1min, the difference between the maximum and minimum irradiance values measured must be < 20W/m²**

The final OUTCOME can be:

- **Non-displayable**: if the obtained values are inconsistent (e.g. nDC >1.15) or if irradiation has never reached a **steady** value > minimum threshold set.
- The maximum performance of the system

The highest performance (maximum value of nDC) is detected according with previous relationships

12. SERVICE

12.1. WARRANTY CONDITIONS

This instrument is warranted against any material or manufacturing defect, in compliance with the general sales conditions. During the warranty period, defective parts may be replaced. However, the manufacturer reserves the right to repair or replace the product.

Should the instrument be returned to the After-sales Service or to a Dealer, transport will be at the Customer's charge. However, shipment will be agreed in advance. A report will always be enclosed to a shipment, stating the reasons for the product's return. Only use original packaging for shipment; any damage due to the use of non-original packaging material will be charged to the Customer. The manufacturer declines any responsibility for injury to people or damage to property.

The warranty shall not apply in the following cases:

- Repair and/or replacement of accessories and battery (not covered by warranty).
- Repairs that may become necessary as a consequence of an incorrect use of the instrument or due to its use together with non-compatible appliances.
- Repairs that may become necessary as a consequence of improper packaging.
- Repairs which may become necessary as a consequence of interventions performed by unauthorized personnel.
- Modifications to the instrument performed without the manufacturer's explicit authorization.
- Use not provided for in the instrument's specifications or in the instruction manual.

The content of this manual cannot be reproduced in any form without the manufacturer's authorization.

Our products are patented and our trademarks are registered. The manufacturer reserves the right to make changes in the specifications and prices if this is due to improvements in technology

12.2. SERVICE

If the instrument does not operate properly, before contacting the After-sales Service, please check the conditions of battery and cables and replace them, if necessary. Should the instrument still operate improperly, check that the product is operated according to the instructions given in this manual.

Should the instrument be returned to the After-sales Service or to a Dealer, transport will be at the Customer's charge. However, shipment will be agreed in advance. A report will always be enclosed to a shipment, stating the reasons for the product's return. Only use original packaging for shipment; any damage due to the use of non-original packaging material will be charged to the Customer.