

R2160

REED INSTRUMENTS

Thermal Imaging Camera



Instruction Manual

Table of Contents

Introduction	3
Product Quality.....	3
Safety	3-4
Features.....	4
Included.....	5
Specifications	5-6
Instrument Description	7
Display Description	8
<i>Power ON/OFF</i>	8
Emissivity.....	9
Software Installation	10
Operating Instructions.....	10-17
<i>Main Menu</i>	10
<i>Switching the Unit of Measure (°F/°C)</i>	11
<i>Enabling/Disabling Center Point & High/Low Temperature Tracking</i>	11
<i>Center Point Tracking</i>	11
<i>Color Palette Selection</i>	12
<i>Enabling/Disabling High and Low Temperature Alarms</i>	12
System Settings.....	12-16
<i>Setting the Language</i>	13
<i>Setting the Date and Date Format</i>	13
<i>Adjusting Emissivity</i>	14
<i>Enabling/Disabling Auto Power OFF</i>	14
<i>Setting the LCD Brightness</i>	14
<i>Enabling/Disabling Temperature Bar</i>	15
<i>Setting the High/Low Alarm Values</i>	15
<i>Device Information</i>	15

continued...

Factory Reset	16
Formatting the SD Card	16
Enabling/Disabling Auto Save	16
Saving, Viewing & Deleting Images	17
Applications.....	17
Accessories and Replacement Parts	18
Product Care	18
Product Warranty	18
Product Disposal and Recycling	18
Product Support.....	19

Introduction

Thank you for purchasing your REED R2160 Thermal Imaging Camera. Please read the following instructions carefully before using your instrument. By following the steps outlined in this manual your meter will provide years of reliable service.

Product Quality

This product has been manufactured in an ISO9001 facility and has been calibrated during the manufacturing process to meet the stated product specifications. If a certificate of calibration is required please contact the nearest authorized REED distributor or authorized Service Center. Please note an additional fee for this service will apply.

Safety

- Never attempt to repair or modify your instrument. Dismantling your product, other than for the purpose of replacing batteries, may cause damage that will not be covered under the manufacturer's warranty. Servicing should only be provided by an authorized service center.
- Do not point the thermal imager (with or without the lens cover) at intensive energy sources as this can damage the thermal imager.
- Do not use the thermal imager in a temperature higher than 122°F (50°C).
- Always charge the battery between 32 to 122°F (0 to 50°C).

continued...

- Clean the case with a damp cloth and a diluted soap solution.
- Do not use abrasives, isopropyl alcohol, or solvents to clean the instrument, lens or screen.
- Do not clean the infrared lens too vigorously, this can damage the anti-reflective coating.
- Store the thermal imager in cool and dry environment.
- Please use the correct emissivity to obtain accurate temperature measurements.
- To ensure accuracy, please let the instrument warm up for 10 minutes before taking a measurement if it has not been used for a long time.
- When being charged, the internal temperature of the product will rise, which will lead to inaccurate temperature measurement, it is not recommended to take measurements during or right after charging the instrument.
- The inherent temperature drift of the sensor may occasionally cause inaccurate measurements. In this case, press the  button under the temperature measurement interface to "Calibrate" the sensor.

Features

- 160 x 120 infrared resolution (19,200 pixels)
- 2.8" color TFT Display
- Built-in LED flashlight
- Choice of 5 color palettes
- High and Low temperature spot and alarm indicators
- Dustproof and 6.5' (2m) drop tested
- Rechargeable li-ion battery
- Tripod mountable for continuous long-term monitoring
- View stored data with included software
- Low battery indication and auto shut off

Included

- USB Cable
- Lens Cover
- 16GB Micro SD Card
- Soft Carrying Case

Specifications

Imaging and Optical Specifications

Field of View (FOV):	56 x 42°
Minimum Focus Distance:	0.25m (0.82')
Spatial Resolution:	(IFOV) 11mrad
Thermal Sensitivity (NETD):	<0.05°C (50mK)
Image Capture Frequency:	9Hz
Focus:	Fixed

Measurement

Temperature Range:	14 to 752°F (-10 to 400°C)
Accuracy:	±3.6°F (2°C) or ±2% of reading
Resolution:	0.1°F/°C

Detector Specifications

Detector Type:	Uncooled microbolometer, Focal plane array (FPA)
Spectral Range:	8 to 14µm
IR Resolution:	160 x 120 (19,200 pixels)

Image Presentation and Measurement Analysis

Display:	2.8" color TFT
Color Palettes:	5 (Iron/Rainbow/Gray/ Red-White/White-Blue)
Center Spot:	Yes
Emissivity:	Adjustable (0.01 to 0.99)
Temperature Alarm Indicators:	High/Low (User adjustable)
Automatic Hot/Cold Detection:	Auto hot or cold spot-meter markers

continued...

General Specifications

Display Resolution:	320 x 240 pixels
Image Format:	BMP
LED Flashlight:	Yes
External Memory:	Micro SD card
Auto Shut-off:	Yes (user adjustable 5/10/30 minutes)
Tripod Mountable:	Yes
Low Battery Indicator:	Yes
Power Supply:	3.7V/5000mAh rechargeable Li-ion battery
Battery Life:	Approx. 6 hours
Charging System:	In Camera
Charge Time:	4 hours
PC Connectivity:	USB Cable (Type-C)
Software:	Yes (download from website)
Software OS Compatibility:	Windows 7/8/10/11
Supported Languages:	English and French
Product Certifications:	CE, IP65, 6.5' (2m) drop test
Operating Temperature:	32 to 122°F (0 to 50°C)
Storage Temperature:	-4 to 140°F (-20 to 60°C)
Operating/Storage Humidity Range:	10 to 90%
Maximum Operating Altitude:	6561' (2000m)
Dimensions:	9.3 x 3 x 3.4" (236 x 76 x 86mm)
Weight:	1lbs (454g)

Instrument Description

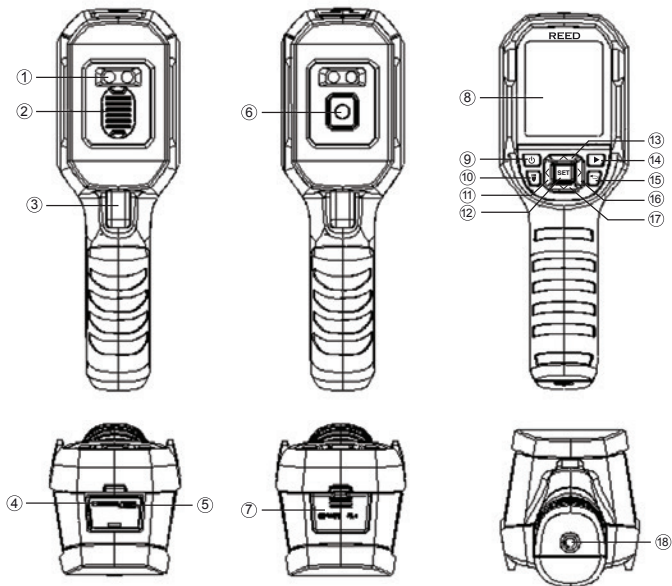

- | | |
|-------------------------|--------------------------|
| 1. LED Lights | 10. Light Button |
| 2. Lens Cap | 11. LEFT Button |
| 3. Trigger | 12. SET Button |
| 4. Micro SD Card Slot | 13. UP Button |
| 5. USB Interface | 14. Playback Button |
| 6. Infrared Camera Lens | 15. BACK Button |
| 7. Interface Cover | 16. RIGHT Button |
| 8. LCD Display | 17. DOWN Button |
| 9. POWER Button | 18. Tripod Mounting Hole |

Display Description

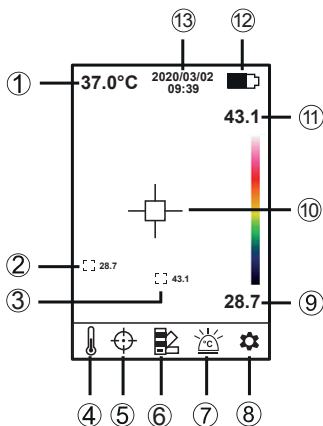

- | | |
|----------------------------------------|------------------------------|
| 1. Center Spot Temperature | 8. Advanced Menu Settings |
| 2. Minimum Spot Temperature | 9. Minimum Spot Temperature |
| 3. Maximum Spot Temperature | 10. Center Spot |
| 4. Temperature Unit of Measure | 11. Maximum Spot Temperature |
| 5. Spot Settings | 12. Battery Indicator |
| 6. Color Palette Settings | 13. Date & Time |
| 7. High/Low Temperature Alarm Settings | |

Power ON/OFF

Press and hold the POWER button for 3 seconds to power on. To turn OFF, press the POWER button for 1 second.

Emissivity

This thermal imager measures infrared energy from the surface of the object and uses this data to calculate an estimated temperature value. Surfaces that are good at radiating energy (high emissivity), the emissivity factor is ≥ 0.90 . Shiny surfaces or unpainted metals are not good at radiating energy (low emissivity) have an emissivity of < 0.6 . To more accurately measure materials with a low emissivity, an emissivity correction is necessary. Emissivity is set directly as a value or from a list of emissivity values for some common materials.

The following table gives typical emissivity of some materials:

Material	Emissivity	Material	Emissivity
Asphalt	0.95	Drywall	0.95
Concrete	0.95	Render	0.94
Hard plaster	0.90	Smoothing cement	0.90
Wood (natural)	0.93	Lacquer	0.92
Lime Stone	0.98	Latex paint	0.97
Ballast chipping	0.95	Wallpaper	0.93
Paper (every color)	0.95	Tiling	0.93
Plastics non film	0.95	Parquet floor	0.90
Tissue (fabric)	0.95	Laminate	0.90
Sand	0.90	PVC-Floor	0.92
Glass wool	0.90	Brick	0.93
Melted asphalt	0.93	Cliff	0.97
Screed/pavement	0.93	Roofing cardboard	0.93
Foamed polystyrene	0.94	Stucco	0.91

Software Installation

Visit www.reedinstruments.com/software to download the R2160 software.

Full specifications and Operating System compatibility can be found on the product page at www.reedinstruments.com.

If you have specific questions related to your application and/or questions related to software setup and functionality please contact the nearest authorized distributor or Customer Service at info@reedinstruments.com or 1-877-849-2127.





Operating Instructions

Main Menu

1. Press the **SET** button to enter the main menu.





2. Use the < and > buttons to scroll through the list of parameters.

	Switching the Unit of Measure (°F/°C)
	Enabling/Disabling Center Point & High/Low Temperature Spots
	Color Palette Selection
	Enabling/Disabling High and Low Temperature Alarms

3. Follow the instructions below to adjust each parameter.

continued...





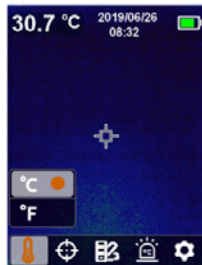





Switching the Unit of Measure (°F/°C)

1. Press the **SET** button when the temperature unit of measure submenu  is selected.
2. Use the  and  buttons to switch between °C or °F.
3. Press the **SET** button to save your selection and return to the main menu.
4. Press the **SET** button again to exit the main menu and resume normal operation.



Enabling/Disabling Center Point & High/Low Temperature Spots

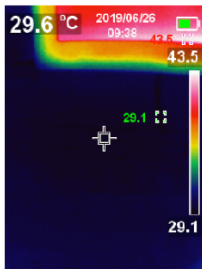

Center Point Tracking

1. Press the **SET** button when the temperature unit of measure submenu  is selected.
2. Use the  and  buttons to switch between  or .
3. For center point, press the **SET** button when  is highlighted to enable  or disable  this feature.
4. For temperature tracking, press the **SET** button when  is highlighted to enable  or disable  this feature.
5. Press the **SET** button to save your selection and return to the main menu.
6. Press the **SET** button again to exit the main menu and resume normal operation.





continued...

Color Palette Selection

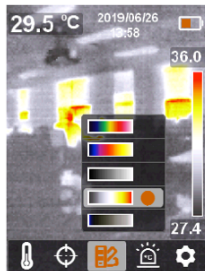
1. Press the **SET** button when the temperature unit of measure submenu  is selected.
2. Use the  and  buttons to select the desired color palette from Iron, Rainbow, Gray, Red-White, and White-Blue.
3. Press the **SET** button to save your selection and return to the main menu.
4. Press the **SET** button again to exit the main menu and resume normal operation.



Enabling/Disabling High and Low Temperature Alarms



1. Press the **SET** button when the temperature unit of measure submenu  is selected.
2. Use the  and  buttons to enable or disable high or low alarm.

Note: Each alarm can be enabled/disabled separately.

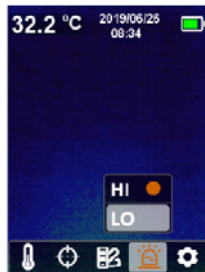
3. Press the **SET** button to save your selection and return to the main menu.
4. Press the **SET** button again to exit the main menu and resume normal operation.



Advanced Settings Menu

1. While in the main menu screen, press the **SET** button when  is highlighted to enter advanced settings menu.
2. Use the  and  buttons to scroll through the following parameters.
3. Once the appropriate parameter has been selected follow the associated instructions below.



continued...

Setting the Language

1. Press the **SET** button when "Language" is highlighted to enter the appropriate function.
2. Press the \wedge and \vee buttons to scroll through the list of languages.
3. Press the **SET** button to confirm selection.
4. Press the \leftarrow button to exit the "Language" function and return to advanced settings.

Setting the Date and Date Format

1. Press the **SET** button when "Date & Time" is highlighted to enter the appropriate function.
2. Use the \langle and \rangle buttons to select the parameter to be adjusted.
3. Press the **SET** button followed by the \wedge and \vee buttons to adjust the selected parameter.
4. Press the **SET** button again to confirm selection.
5. Repeat steps 2 through 4 for each required parameter.
6. Press the \leftarrow button to exit the "Date & Time" function when complete and return to advanced settings.

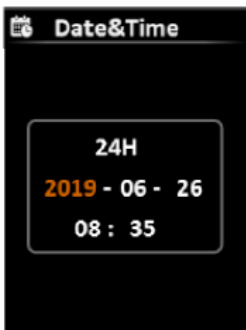
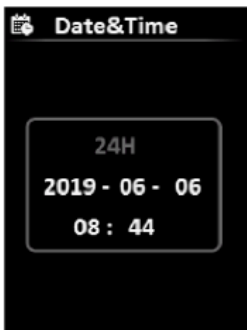

continued...

Adjusting Emissivity

1. Press the **SET** button when "Emissivity" is highlighted to enter the appropriate function.
2. Press the **SET** button again to adjust the selected emissivity.
3. Use the \wedge and \vee buttons to increase or decrease the emissivity values.
4. Press the **SET** button to confirm selection.
5. Press the \leftarrow button to exit the "Emissivity" function and return to advanced settings.



Enabling/Disabling Auto Power Off

1. Press the **SET** button when "Auto Power Off" is highlighted to enter the appropriate function.
2. Press the \wedge and \vee buttons to select the desired Auto Power Off option between "Off", "5 Min", "10 Min" or "30 Min".
3. Press the **SET** button to confirm selection.
4. Press the \leftarrow button to exit the "Auto Power Off" function and return to advanced settings.

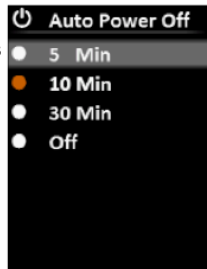

Setting the LCD Brightness

1. Press the **SET** button when "Brightness" is highlighted to enter the appropriate function.
2. Press the \wedge and \vee buttons to select the desired brightness level between "Low", "Middle" or "High".
3. Press the **SET** button to confirm selection.
4. Press the \leftarrow button to exit the "LCD Brightness" function and return to advanced settings.



continued...

Enabling/Disabling Temperature Bar

1. Press the **SET** button when "Temp Bar" is highlighted to enter the appropriate function.
2. Press the \wedge and \vee buttons to select between ON or OFF.
3. Press the **SET** button to confirm selection.
4. Press the \leftarrow button to exit the "Temperature Bar" function and return to advanced settings.

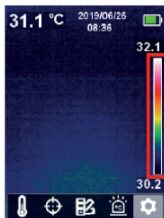
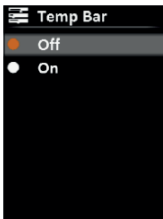

Temperature Bar

Setting the High/Low Alarm Values

1. Press the **SET** button when "HI/LO Alert" is highlighted to enter the appropriate function.
2. Press the \wedge and \vee buttons to select the parameter to be adjusted.
3. Press the **SET** button to confirm selection.
4. Use the \wedge and \vee buttons to increase or decrease the alarm values.
5. Press the **SET** button to confirm selection.
6. Repeat steps 2 through 5 for each parameter.
7. Press the \leftarrow button to exit the "High/Low Alarms" function and return to advanced settings.

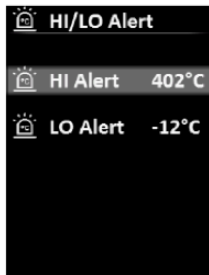

Device Information

1. Press the **SET** button when "Device Info" is highlighted to view detailed information of the device.
2. Press the \leftarrow button to exit the "Device Info" function and return to advanced settings.



continued...

Factory Reset

1. Press the **SET** button when "Factory Reset" is highlighted to view detailed information of the device.
2. Press the \wedge and \vee buttons to select between "Yes" or "No".
3. Press the **SET** button to confirm selection.
4. Press the \leftarrow button to exit the "Factory Reset" function and return to advanced settings.



Formatting the SD Card

1. Press the **SET** button when "Format SD" is highlighted to view detailed information of the device.
2. Press the \wedge and \vee buttons to select between "Yes" or "No".
3. Press the **SET** button to confirm selection.
4. Press the \leftarrow button to exit the "Formatting SD Card" function and return to advanced settings.



Enabling/Disabling Auto Save

1. Press the **SET** button when "Auto Save" is highlighted to view detailed information of the device.
2. Press the \wedge and \vee buttons to select between "Yes" or "No".
3. Press the **SET** button to confirm selection.
4. Press the \leftarrow button to exit the "Auto Save" function and return to advanced settings.

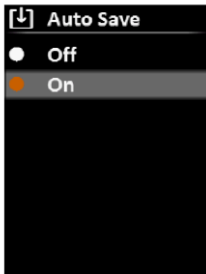

continued...

Saving, Viewing & Deleting Images

While in normal operation, multiple images can be saved to the Micro SD card.











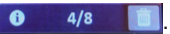

1. To save an image, pull the trigger.
2. To display a saved image, press the  button to enter the saved pictures gallery.
3. Use the  and  buttons to scroll through the list of saved pictures.
4. Press the **SET** button to enter the saved picture toolbar as indicated by  4/8 .
5. Use the  and  buttons to select between "Image Details"  to view all relevant information on the saved image or delete saved image .
6. Press the **SET** button to confirm your selection.
7. If "Image Details" is selected, the display will appear as shown in Figure A.
8. Press the  button to return to the saved pictures menu.
9. If "Delete an Image" is selected, use the  and  buttons to select between "Yes" or "No" as shown in Figure B.
10. Press the **SET** button to confirm your selection.
11. Press the  button to exit the saved pictures menu and resume normal operation.



Figure A

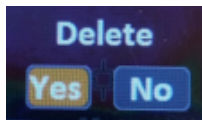

Figure B

Charging the Battery

1. Connect the R2160 via the included cable to a USB port on your PC or into a wall outlet using a USB Power Adapter (not included) to charge the Li-ion battery.

Note: The meter must remain powered off or safely removed from hardware flash drive in order to properly charge via the USB port on your PC.

2. Charge the meter until the battery indicator appears full and remove the charging cable when done.

Applications

- Home and Building Inspection
- Plant and General Maintenance
- Electrical and Mechanical Inspection
- Predictive Maintenance
- HVAC/R & Plumbing
- Equine & Veterinary
- Road Construction

Accessories and Replacement Parts

R8888 Hard Carrying Case

Don't see your part listed here? For a complete list of all accessories and replacement parts visit your product page on www.reedinstruments.com.

Product Care

To keep your instrument in good working order we recommend the following:

- Store your product in a clean, dry place.
- Clean your product and accessories with biodegradable cleaner. Do not spray the cleaner directly on the instrument. Use on external parts only.

Product Warranty

REED Instruments guarantees this instrument to be free of defects in material or workmanship for a period of one (1) year from date of shipment. During the warranty period, REED Instruments will repair or replace, at no charge, products or parts of a product that proves to be defective because of improper material or workmanship, under normal use and maintenance. REED Instruments total liability is limited to repair or replacement of the product. REED Instruments shall not be liable for damages to goods, property, or persons due to improper use or through attempts to utilize the instrument under conditions which exceed the designed capabilities. In order to begin the warranty service process, please contact us by phone at 1-877-849-2127 or by email at info@reedinstruments.com to discuss the claim and determine the appropriate steps to process the warranty.

Product Disposal and Recycling



Please follow local laws and regulations when disposing or recycling your instrument. Your product contains electronic components and must be disposed of separately from standard waste products.

Product Support

If you have any questions on your product, please contact your authorized REED distributor or REED Instruments Customer Service by phone at 1-877-849-2127 or by email at info@reedinstruments.com.

Please visit www.REEDInstruments.com for the most up-to-date manuals, datasheets, product guides and software.

*Product specifications subject to change without notice.
All rights reserved. Any unauthorized copying or reproduction of this manual is strictly prohibited without prior written permission from REED Instruments.*

REED

INSTRUMENTS

TEST & MEASURE WITH CONFIDENCE



CHECK OUT OUR LATEST PRODUCTS!

www.REEDInstruments.com

Find Quality Products Online at:

www.GlobalTestSupply.com

sales@GlobalTestSupply.com