



T90/T110/T130/T150

Voltage/Continuity Tester

Instruction Sheet

Introduction

The Fluke T90/T110/T130/T150 Electrical Testers (the Tester or Product) are voltage and continuity testers with a rotary field indication (T110/T130/T150 only). Their primary use is for test and measurement in industrial, commercial, and household environments. This Product complies with the most recent safety standards for safe, reliable test and measurement. The fixed test probe cover prevents the risk of injury when you move the instrument.

How to Contact Fluke

To contact Fluke, call one of the following telephone numbers:

- Germany: 07684 - 80 09 545
- France: 01 48 17 37 37
- United Kingdom: +44-0-1603256600

Go to www.fluke.com to register your product, download manuals, and find more information.

To view, print, or download the latest manual supplement, visit <http://us.fluke.com/usen/support/manuals>.

Safety Information

Warning





To prevent possible electrical shock, fire, or personal injury:

- Read all safety information before you use the Product.
- Use the Product only as specified, or the protection supplied by the Product can be compromised.
- Measure a known voltage first to make sure that the Product operates correctly.
- Do not apply more than the rated voltage, between the terminals or between each terminal and earth ground.

- Limit operation to the specified measurement category or voltage ratings.
- Do not work alone.
- Comply with local and national safety codes. Use personal protective equipment (approved rubber gloves, face protection, and flame-resistant clothes) to prevent shock and arc blast injury where hazardous live conductors are exposed.
- Do not use the Product around explosive gas, vapor, or in damp or wet environments.
- Do not use and disable the Product if it is damaged.
- Do not use the Product if it operates incorrectly.
- Keep fingers behind the finger guards on the probes.
- Do not use the Product if the test leads are damaged.
- Examine the case before you use the Product. Look for cracks or missing plastic.
- The battery door must be closed and fastened before you operate the Product.
- Replace the batteries when the low battery indicator shows to prevent incorrect measurements.
- Repair the Product before use if the battery leaks.
- For use by competent persons. Anyone using this Product should be knowledgeable and trained about the risks involved with measuring voltage, especially in an industrial setting, and the importance of taking safety precautions and of testing the Product before and after using it to ensure that it is in good working condition.

Symbols

These symbols are on the Tester or in this instruction sheet.

Symbol	Explanation
	Important information. Consult the instruction sheet.
	Hazardous Voltage.
	Suitable for live working.
	Conforms to European Union Directives
CAT III	Measurement Category III is applicable to test and measuring circuits connected to the distribution part of the building's low-voltage MAINS installation.
CAT IV	Measurement Category IV is applicable to test and measuring circuits connected at the source of the building's low-voltage MAINS installation.

Symbol	Explanation
	This product complies with the WEEE Directive (2002/96/EC) marking requirements. The affixed label indicates that you must not discard this electrical/ electronic product in domestic household waste. Product Category: With reference to the equipment types in the WEEE Directive Annex I, this product is classed as category 9 "Monitoring and Control Instrumentation" product. Do not dispose of this product as unsorted municipal waste. To Fluke's website for recycling information.

Accessories

The Tester is supplied with accessories.

Part Number	Accessory
4083642	GS38 Probe Tip Sheath
4083656	4 mm Ø Probe Extensions
4111533	H15 Belt Holster (sold separately)
4111540	C150 Zippered Soft Carrying Case (sold separately)

Figure 1 shows the Probe Tip Protector Cap. This multifunctional accessory is useful for tests and storage of different accessories.

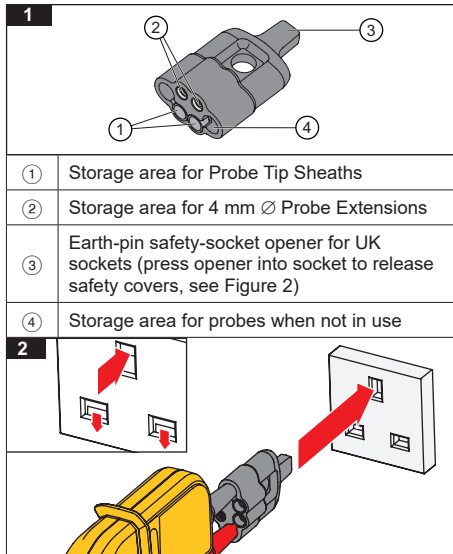
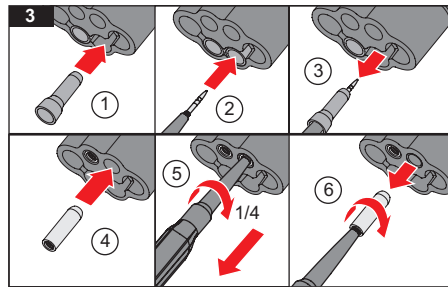





Figure 3 illustrates how to store and retrieve the tip accessories from the cap.



①	For storage, push Probe Tip Sheath into place.
②	To retrieve, firmly push probe tip into Probe Tip Sheath.
③	Pull on probe handle to remove Probe Tip Sheath.
④	For storage, push 4 mm Ø Probe Extensions into place.
⑤	To retrieve, firmly push probe tip into Probe Extensions. Twist 1/4 turn.
⑥	Pull on probe handle to remove Probe Extensions. Continue to twist until tip is tight.

Quick Reference

Use the pushbuttons to turn the functions on or off. See the list that follows for a quick reference to each of these pushbuttons.

Pushbutton	Description
	Push to turn torch light on or off (T110, T130, T150). To save battery power the function automatically turns off after 30 seconds.
HOLD	Push to hold the value that shows in the LCD in volt and resistance measurements. Push again to turn HOLD off (T130, T150). To save battery power the function automatically turns off after 30 seconds.
	Push this button on each of the probes at the same time to start the test for low impedance switchable load.
 2 SEC	Push and hold for 2 seconds to turn the beeper on or off. The status shows on the LCD (T150, T130) or with the LED (T110).
HOLD 2 SEC Ω	Push and hold for 2 seconds to turn the resistance measurement on or off (T150 only). To save battery power, the function automatically turns off after 30 seconds.

Features

	Model			
	T90	T110	T130	T150
Complies with EN 61243-3:2014	•	•	•	•
LED Indication Range: 12 V to 690 V dc and ac	•	•	•	•
V Display: Multiple LED Bargraph	•	•	•	•
Independent ELV indicator LED, indicates if >50 V ac/120 V dc is present even in the event of no battery power or main circuit failure	•	•	•	•
LCD Indication Range: 6 V to 690 V dc and ac			•	•
V Display: Digital LCD 3½ digit (1 V resolution)			•	•
Resistance Measurement: LCD 3½ digit (0 to 1999 Ω/1Ω resolution)				•
LCD Backlight			•	•
Display HOLD: Freeze/unfreeze display with voltage or resistance measurement			•	•
CAT II 690 V / CAT III 600 V	•			
CAT III 690 V / CAT IV 600 V		•	•	•
Rugged, Double-Insulated Wire	•	•	•	•
Fixed Impedance ~200 kΩ (~3.5 mA @ 690 V)	•	•	•	•
Switchable Load by 2 pushbuttons (30 mA @ 230 V)		•	•	•
Vibration During Load (when 2 switchable load pushbuttons are pushed)		•	•	•
Single-Pole Phase Test (also operates with gloves)	•	•	•	•
Rotary Field Direction (also operates with gloves)		•	•	•
Continuity Test / Diode Test	•	•	•	•
Torch		•	•	•
Beeper for Continuity/Phase/ACV (switchable)		•	•	•
Beeper for Continuity/Phase/ACV (nonswitchable)	•			
IP54	•			
IP64		•	•	•
Slim Metal Probe Tips (threaded base for included tip accessories)	•	•	•	•
Probe Tip Protector Cap (secure storage for the docked probes)	•	•	•	•
4 mm Ø Probe Tip Thickness Extensions (for better fit in outlets)	•	•	•	•
19 mm Probe Tip distance when docked	•	•	•	•
Probe Tip Sheath (UK GS38 sheath—keeps the exposed metal to a <4 mm limit)	•	•	•	•
Slim Probe for Ultra-Compact Form Factor	•			

Display

LEDs (All Models)	Description
	Voltage level is backlit
	Voltage level is more than ELV limit (>50 V ac or >120 V dc)
	Voltage is ac / phase in Single Pole Phase test
	Voltage is positive or negative at the indicator probe
	Battery is low / Replace battery
	Silent mode (T110)
	Continuity or diode in forward operation
	Switchable load is ON (two buttons pressed and current flows)
	3-phase sequence indication detected left or right turning phases with nonindicator probe (L1) to indicator probe (L2)
LCD (T130/T150)	Description
①	Silent mode (T130/T150)
②	Display is in HOLD mode
③	Voltage measurement (T130/T150) or resistance measurement (T150)
④	Resistance measurement (T150)
⑤	AC Voltage measurement
⑥	DC Voltage measurement
⑦	Battery is low / Replace battery

How to Hold the Tester

Always hold the product behind the barrier to keep the display in view. See Figure 4.

⚠ ⚠ Warning

To prevent possible electric shock, never touch the metal pins of the probes when power is applied.

Self-Test

The Tester has a built-in self test function.

Before and after use, do a self-test:

1. Touch and hold the probe tips together.
 - shows and you can hear the beeper (when active on the T110/T130/T150). Or, in the silent mode, the LED is on (when active on the T110). This makes sure that the test leads have continuity.
2. Make sure that:
 - batteries are good
 - (T90, T110) is NOT on
 - (T130, T150) does not show in the display
3. Continue to hold the probe tips together for more than three seconds.
4. Open the probe tips again. All LEDs (all but and) must be on and all symbols in the LCD (T130, T150) show for one second. This test makes sure that all other internal circuits and indicators are good.
5. Measure a known voltage such as a 230 V socket outlet. This completes the self-test and includes the >ELV circuit.

If the Tester fails the self-test or voltage test, do not use. See *To Contact Fluke* for service.

For an inspection of the insulation, cables, and case, see *Safety Information*.

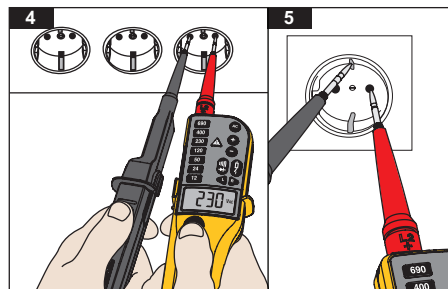

Resistance Test (T150)

The Tester measures low ohm resistances between 1 Ω and 1999 Ω at a resolution of 1 Ω .

To do a resistance test:

1. Do a Voltage test to make sure the UUT is not live.
2. Connect the two test probes with the UUT. Push and hold **HOLD** $\frac{3000}{\Omega}$ for 2 seconds and read value on the display.
3. Push and hold **HOLD** $\frac{3000}{\Omega}$ for 2 seconds to turn the function off.

To save battery power the function automatically turns off after 30 seconds. The Tester automatically goes into the voltage measurement mode if voltage is sensed.

Display HOLD (T130/T150)

The T130 and T150 include a Display HOLD function for the LCD.

To use the Display HOLD function:

1. Push HOLD to freeze the LCD while in a Voltage or Resistance measurement. The status is shown in the display with a HOLD symbol.
2. Push HOLD again to unfreeze the LCD.

To save battery power the Display HOLD function automatically turns off after 30 seconds.

Rotary Field Indication (T110/T130/T150)

The Tester has a double-pole rotary field indicator. The 3rd pole is capacitively-coupled into the unit from the user's hand. The Tester operates without a touch electrode and is also usable when you wear gloves.

◀ and ▶ display for ac voltage measurements, but the rotary direction is found only in a three-phase system. In parallel, the Tester reads the voltage between two external conductors.

To use the rotary field indicator:

1. Connect the test probe with the phase L1 and the indicator probe with the phase L2.
2. Firmly hold the indicator probe around its body (between the finger guard and cable).

The voltage and the rotary field direction show on the display. ▶ (see Figure 6) signifies that the supposed phase L1 is the actual phase L1 and the supposed

phase L2 is the actual phase L2 right rotary field.

◀ (see Figure 7) signifies that the supposed phase L1 is the actual phase L2 and the supposed phase L2 is the actual phase L1 left rotary field. A retest with exchanged test probes will cause the opposite symbol to illuminate.

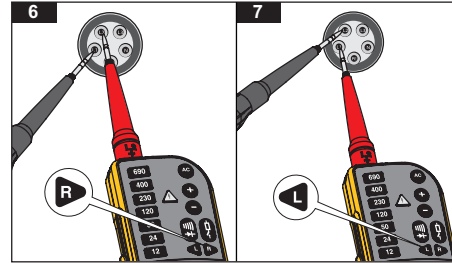

Torch and Backlight (T110/T130/T150)

The T110/T130/T150 include a torch and backlight function. This function is helpful in areas with unsatisfactory light, for example, division switch cabinets.

To use the torch or backlight:

1. Push **▶** to turn the torch and backlight on.
2. Push **▶** again to turn the torch and backlight off.

To save battery power the function automatically turns off after 30 seconds.

Maintenance

⚠ Warning

For safe operation and maintenance of the product:

- Be sure that the battery polarity is correct to prevent battery leakage.
- Remove batteries to prevent battery leakage and damage to the Product if it is not used for an extended period or if it is stored above or below its operating temperature.
- Do not disassemble the Product beyond removal of the battery door.
- Repair the Product before use if the battery leaks.

⚠ Warning

To prevent personal injury:

- Batteries contain hazardous chemicals that can cause burns or explode. If exposure to chemicals occurs, clean with water and get medical aid.
- Have an approved technician repair the Product.
- Remove the input signals before you clean the Product.
- Use only specified replacement parts.
- Keep the Tester dry and clean.
- Do not operate the Product with covers removed or the case open. Hazardous voltage exposure is possible.

Voltage Test

A voltage test is the main function of the Tester. The T90 and T110 have an LED bargraph indication to show the nominal voltage levels. The T130 and T150 also show the values in the LCD.

Connect the two test probes to the UUT to do a voltage test.

Above 12 V the Tester turns on automatically. For the T130 and T150, the LCD comes on at 6 V. The backlit LEDs show the nominal voltage level, for example **120** or **230**.

For the T130 and T150, the voltage is measured and the value is shown on the LCD as for example, **227 Vac**.

The voltage value on the LCD must not be used to validate a zero voltage. Always use the LED bargraph. For ac voltages, the **AC** LED and the **VAC** symbol in the LCD (T130/T150) illuminates. For dc voltages, the polarity of the display voltage refers to the instrument test probe with the **+** and **-** LEDs or the **+** or **-** symbol in the LCD (T130/T150). For voltages that are more than the ELV limit (>50 V ac or >120 V dc), **△** comes on in the display. The voltage LED bargraph and the >ELV indicator must not be used for measurements. For measurements you can use the LCD on the T130/T150 to see the actual value.

When the LED bargraph does not indicate the presence of voltage (no LEDs illuminated), Fluke highly recommends that you install earthing equipment before work.

Voltage Test with Switched Load, RCD Trip Test (T110/T130/T150)

During voltage tests, you can decrease the interference voltages from inductive or capacitive coupling by loading the UUT with a lower impedance than the Tester has in normal mode. In systems with RCD circuit breakers, you can trip an RCD switch with the same low impedance as when you measure voltage between L and PE (see Figure 5).

To do an RCD trip test during voltage measurement, push the two **ⓘ** buttons at the same time. If you have 10 mA or 30 mA RCDs between L and PE in a 230 V system, it will trip.

During load current, the indicator probe side vibrates and the **ⓘ** LED is the indication for the flowing load current. This indication is not to be used for voltage test or measurement.

Due to low impedance, this circuit is overload-protected and will decrease the load current after 20 seconds @ 230 V and after 2 seconds @ 690 V.

If the two pushbuttons are not used, the RCDs will not

Single-Pole Phase Test

To do a single-pole phase test:

1. Firmly hold the indicator probe around its body (between the finger guard and cable).
2. Touch the probe tip to an unknown contact to find the conductor.

AC turns on when the ac voltage is >100 V and you hear the beeper (T110/T130/T150 only).

For a single-pole phase test to find external conductors, the display function operates unreliably in some conditions. An example is insulated body protective equipment on insulated locations, such as a PVC floor or fiberglass ladder.

The Tester operates without a touch electrode and is usable when you wear gloves. The single-pole phase test is not meant to find if a conductor is live or not. For this function, always use the Voltage test.

Continuity/Diode Test

To do a continuity test of cables, switches, relays, bulbs, or fuses:

1. Do a Voltage test to make sure the UUT is not live.
2. Connect the two test probes with the UUT. You will hear the beeper if it is on (T110/T130/T150 only) for continuity and **ⓘ** is on.

The test voltage/current polarity for a diode test at the non-indicator test probe is positive **+** and the indicator test probe is negative **-**.

Note

The Tester automatically goes into the voltage measurement mode if voltage is sensed.

Beeper (T110/T130/T150)

For Continuity, AC Voltage, and Single-Pole Phase Test modes, you can turn the beeper on or off:

1. Push and hold **ⓘ** ^{SEC} for 2 seconds to turn the beeper on.
2. Push and hold **ⓘ** ^{SEC} for 2 seconds to turn the beeper off.

The status shows together with Volt, Continuity, or Single-Pole Phase indications in the LED or LCD.

The beeper mode is stored until you change it. Always do a continuity test (touch probe tips together) to make sure that the beeper operates before you start a test.

In work areas with high background noise, make sure you can hear the beeper before you start a test.

Specifications

		Model			
		T90	T110	T130	T150
LEDs					
Voltage range	12 V to 690 V ac/dc	•	•	•	•
Resolution	±12 V, 24 V, 50 V, 120 V, 230 V, 400 V, 690 V	•	•	•	•
Tolerance	Complies with EN 61243-3:2014	•	•	•	•
Frequency range	0 / 40 Hz to 400 Hz	•	•	•	•
Response time	≤0.5 second	•	•	•	•
Auto power on	≥12 V ac/dc	•	•	•	•
LCD					
Voltage range	6 V to 690 V ac/dc			•	•
Resolution	±1 V			•	•
Tolerance	±(3 % rdg + 5 digits)			•	•
Frequency range	0 / 40 Hz to 400 Hz			•	•
Response time	≤1 second			•	•
Auto power on	≥6 V ac/dc			•	•
Voltage detection	Automatic	•	•	•	•
Polarity detection	Full range	•	•	•	•
Range detection	Automatic	•	•	•	•
Internal basic load impedance Peak current	Maximum 3.5 mA at 690 V 200 kΩ / Is <3.5 mA (no RCD tripping)	•	•	•	•
Operation time	Duration Time = 30 seconds	•	•	•	•
Recovery time	Recovery Time = 240 seconds	•	•	•	•
Switchable Load	~7 kΩ		•	•	•
Peak current	Is (load) = 150 mA		•	•	•
RCD tripping	I~30 mA @ 230 V		•	•	•
Continuity Test	0 to 400 kΩ	•	•	•	•
Accuracy	nominal resistance +50 %	•	•	•	•
Test current	≤5 μA	•	•	•	•
Single-pole Phase Test	100 V ac to 690 V ac	•	•	•	•
Frequency range	40 Hz to 60 Hz	•			
	50 Hz to 400 Hz		•	•	•
Rotary Field Indication					
Voltage range (LEDs)	100 V to 690 V (phase to earth)		•	•	•
Frequency range	50 Hz to 60 Hz		•	•	•
Resistance Measurement					
	0 Ω to 1999 Ω				•
Resolution	1 Ω				•
Tolerance	±(5 % rdg +10 digits) @ 20 °C				•
Temperature coefficient	±5 digits / 10 K				•
Test current	≤30 μA				•
Size in mm (HxWxL)		245x64x28		255x78x35	
Weight in kg (includes batteries)		0.18		0.27	

Environmental	
Pollution degree	2
Protection degree	IP54 (T90) IP64 (T110/T130/ T150)
Operating Temperature	-15 °C to +45 °C
Storage Temperature.....	-20 °C to +60 °C
Humidity	85 % RH maximum
Altitude	2000 m
Vibration	refer to EN61243-3
Safety EN61243-3:2014	
Transporting goods.....	VBG 1, § 35
Overvoltage protection	690 V ac/dc
Measurement category	
T90.....	CAT II 690 V
	CAT III 600 V
T110/T130/T150	CAT III 690 V
	CAT IV 600 V
Power supply	2 x 1.5 V Micro / LR03 / AAA
Power consumption	50 mA maximum / ~250 mW
Language support	Czech, Dutch, English, Finnish, French, German, Italian, Norwegian, Polish, Portuguese, Romanian, Russian, Spanish, Swedish, Turkish

How to Clean

Before you clean the Tester, remove it from all measurement circuits.



⚠ Caution
To prevent damage, do not use abrasives or solvents on the Tester.

Clean the case with a moist cloth and weak detergent. After you clean the Tester, do not use it for a period of 5 hours.

When to Calibrate

Fluke recommends a calibration interval of 1 year.

Battery Replacement

If  (Fluke T90/T110) is on or  shows in the LCD (Fluke T130/T150) during tests or measurements, replace the batteries.

To replace the batteries:

1. Disconnect the Tester from the measurement circuit.
2. Open the battery cover. See Figure 8.
3. Remove the discharged batteries.
4. Replace with two new 1.5V IEC LR03 AAA batteries.
5. Align the battery polarity as shown on the case housing.
6. Close and attach the battery cover.

Note

Do not overtighten the screw for the battery cover.

7. Complete a self-test.

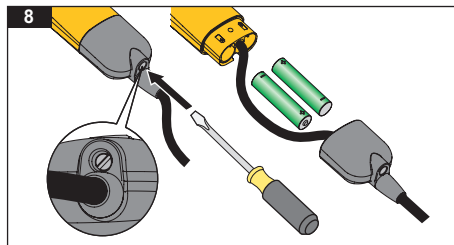

LIMITED WARRANTY & LIMITATION OF LIABILITY

This Fluke product will be free from defects in material and workmanship for two years from the date of purchase. This warranty does not cover fuses, disposable batteries, or damage from accident, neglect, misuse, alteration, contamination, or abnormal conditions of operation or handling. Resellers are not authorized to extend any other warranty on Fluke's behalf. To obtain service during the warranty period, contact your nearest Fluke authorized service center to obtain return authorization information, then send your defective Tester to that Service Center with a description of the problem. Replace depleted batteries immediately to avoid Tester damage from battery leakage.

THIS WARRANTY IS YOUR ONLY REMEDY. NO OTHER WARRANTIES, SUCH AS FITNESS FOR A PARTICULAR PURPOSE, ARE EXPRESSED OR IMPLIED. FLUKE IS NOT LIABLE FOR ANY SPECIAL, INDIRECT, INCIDENTAL OR CONSEQUENTIAL DAMAGES OR LOSSES, ARISING FROM ANY CAUSE OR THEORY. Since some states or countries do not allow the exclusion or limitation of an implied warranty or of incidental or consequential damages, this limitation of liability may not apply to you.

Fluke Europe B.V