

**TiX500, TiX501, TiX520,
TiX560, TiX580**
Expert Series Thermal Imagers

Users Manual

Ⓢ

February 2015 Rev. 2, 4/19

© 2015-2019 Fluke Corporation. All rights reserved. Specifications are subject to change without notice.

All product names are trademarks of their respective companies.

LIMITED WARRANTY AND LIMITATION OF LIABILITY

Each Fluke product is warranted to be free from defects in material and workmanship under normal use and service. The warranty period is two years and begins on the date of shipment. Parts, product repairs, and services are warranted for 90 days. This warranty extends only to the original buyer or end-user customer of a Fluke authorized reseller, and does not apply to fuses, disposable batteries, or to any product which, in Fluke's opinion, has been misused, altered, neglected, contaminated, or damaged by accident or abnormal conditions of operation or handling. Fluke warrants that software will operate substantially in accordance with its functional specifications for 90 days and that it has been properly recorded on non-defective media. Fluke does not warrant that software will be error free or operate without interruption.

Fluke authorized resellers shall extend this warranty on new and unused products to end-user customers only but have no authority to extend a greater or different warranty on behalf of Fluke. Warranty support is available only if product is purchased through a Fluke authorized sales outlet or Buyer has paid the applicable international price. Fluke reserves the right to invoice Buyer for importation costs of repair/replacement parts when product purchased in one country is submitted for repair in another country.

Fluke's warranty obligation is limited, at Fluke's option, to refund of the purchase price, free of charge repair, or replacement of a defective product which is returned to a Fluke authorized service center within the warranty period.

To obtain warranty service, contact your nearest Fluke authorized service center to obtain return authorization information, then send the product to that service center, with a description of the difficulty, postage and insurance prepaid (FOB Destination). Fluke assumes no risk for damage in transit. Following warranty repair, the product will be returned to Buyer, transportation prepaid (FOB Destination). If Fluke determines that failure was caused by neglect, misuse, contamination, alteration, accident, or abnormal condition of operation or handling, including overvoltage failures caused by use outside the product's specified rating, or normal wear and tear of mechanical components, Fluke will provide an estimate of repair costs and obtain authorization before commencing the work. Following repair, the product will be returned to the Buyer transportation prepaid and the Buyer will be billed for the repair and return transportation charges (FOB Shipping Point).

THIS WARRANTY IS BUYER'S SOLE AND EXCLUSIVE REMEDY AND IS IN LIEU OF ALL OTHER WARRANTIES, EXPRESS OR IMPLIED, INCLUDING BUT NOT LIMITED TO ANY IMPLIED WARRANTY OF MERCHANTABILITY OR FITNESS FOR A PARTICULAR PURPOSE. FLUKE SHALL NOT BE LIABLE FOR ANY SPECIAL, INDIRECT, INCIDENTAL OR CONSEQUENTIAL DAMAGES OR LOSSES, INCLUDING LOSS OF DATA, ARISING FROM ANY CAUSE OR THEORY.

Since some countries or states do not allow limitation of the term of an implied warranty, or exclusion or limitation of incidental or consequential damages, the limitations and exclusions of this warranty may not apply to every buyer. If any provision of this Warranty is held invalid or unenforceable by a court or other decision-maker of competent jurisdiction, such holding will not affect the validity or enforceability of any other provision.

11/99

Table of Contents

Title	Page
Introduction	1
Safety Information.....	2
Product Familiarization	5
Features	5
Controls	7
Touch Screen	10
Control Panel.....	11
Basic Operation	11
Turn On and Off the Imager	11
Focus.....	12
Capture Image.....	12
Save Image	12
Menus	13
Measurement Menu	14
Level/Span	16
Emissivity Adjustment	17
Spot Markers.....	18
Spot Box.....	18
Image Menu	20
Image Enhancement.....	23
Distance	25
Camera Menu.....	26
LaserSharp Auto Focus System	28
Video	29
Wireless Connectivity.....	30
Fluke Connect Wireless System	32
Fluke Connect App.....	32
Fluke Connect Tools	32
Memory Menu	33
Review Image	34
Edit Image.....	34

Delete Image.....	36
Settings Menu	37
File Format.....	38
Date	39
Time.....	39
SmartView Software	39
Download SmartView Software.....	40
Download Firmware	40
Enable the Radio.....	40
Streaming Video (Remote Display)	41
Stream Live to a PC	41
Stream Live with Fluke Connect Software	42
Stream Live to an HDMI Device	42
Remote Control of Imager	43
Accessories	44
Optional Lenses	45
Neck Strap.....	46
Maintenance	46
Clean the Product.....	47
Battery Care	47
Charge Batteries	48
Two-Bay Battery Charger Base	48
AC Power Socket on Imager.....	48
Optional 12 V Vehicle Charger	49
Radio Frequency Data.....	49
General Specifications.....	49
Detailed Specifications	51

Introduction

The Fluke TiX500, TiX501, TiX520, TiX560, and TiX580 Expert Series Thermal Imagers (the Product or Imager) are handheld, infrared imaging cameras for use in many applications. These applications include equipment troubleshooting, preventive and predictive maintenance, building diagnostics, and research and development.

The Imager displays thermal images on a high-visibility, industrial-quality LCD touch screen. The Imager can save images to internal memory, to a removable memory card, or to a USB storage device. Saved images and data stored in internal memory or on the memory card can be transferred to a PC through a direct USB connection to the PC or by wireless transfer to a PC or mobile device.

The Imager includes SmartView[®] software. SmartView is a high-performance, professional software suite for quality analysis and reporting. The Imager works with the Fluke Connect[®] app available on mobile devices.

A rugged, rechargeable lithium-ion smart battery provides power to the Imager. Direct AC power is accessible with the included AC power adapter.

Safety Information

A **Warning** identifies hazardous conditions and procedures that are dangerous to the user. A **Caution** identifies conditions and procedures that can cause damage to the Product or the equipment under test.

Warning

To prevent possible electrical shock, fire, or personal injury and for safe operation of the Product:

- Read all safety information before you use the Product.
- Carefully read all instructions.
- Do not alter the Product and use only as specified, or the protection supplied by the Product can be compromised.
- Replace the batteries when the low battery indicator shows to prevent incorrect measurements.
- Do not use the Product if it operates incorrectly.
- Do not use the Product if it is altered or damaged.
- Disable the Product if it is damaged.
- See emissivity information for actual temperatures. Reflective objects result in lower than actual temperature measurements. These objects pose a burn hazard.
- Do not put battery cells and battery packs near heat or fire. Do not put in sunlight.
- Do not disassemble or crush battery cells and battery packs.
- Remove batteries to prevent battery leakage and damage to the Product if it is not used for an extended period.
- Connect the battery charger to the mains power outlet before the charger.

- Use only Fluke approved power adapters to charge the battery.
- Keep cells and battery packs clean and dry. Clean dirty connectors with a dry, clean cloth.
- Batteries contain hazardous chemicals that can cause burns or explode. If exposure to chemicals occurs, clean with water and get medical aid.
- Do not disassemble the battery.
- Repair the Product before use if the battery leaks.
- Use only the external mains power supply included with the Product.
- Do not put metal objects into connectors.
- Use only specified replacement parts.
- Have an approved technician repair the Product.
- Remove the batteries if the Product is not used for an extended period of time, or if stored in temperatures above 50 °C. If the batteries are not removed, battery leakage can damage the Product.
- Disconnect the battery charger and move the Product or battery to a cool, non-flammable location if the rechargeable battery becomes hot (>50 °C) during the charge period.
- Replace the rechargeable battery after 5 years of moderate use or 2 years of heavy use. Moderate use is defined as recharged twice a week. Heavy use is defined as discharged to cutoff and recharged daily.
- Do not short the battery terminals together.
- Do not keep cells or batteries in a container where the terminals can be shorted.
- Do not look into the laser. Do not point the laser directly at persons or animals or indirectly off reflective surfaces.

- Do not look directly into the laser with optical tools (for example, binoculars, telescopes, microscopes). Optical tools can focus the laser and be dangerous to the eye.
- Do not open the Product. The laser beam is dangerous to eyes. Have the Product repaired only through an approved technical site.
- Do not use laser viewing glasses as laser protection glasses. Laser viewing glasses are used only for better visibility of the laser in bright light.
- Do not use the Product for medical reasons. The Product is intended for equipment evaluation only and should never be used in diagnostics, treatment, or any other capacity where the Product would come in contact with a patient.

⚠ Caution

Storage and/or continual operation of the Imager in extreme ambient temperature conditions can result in temporary interruption of operation. If this occurs, let the Imager stabilize (cool down or warm up) before you resume operation.

Table 1 is a list of symbols that can be used on the Imager or in this manual.

Table 1. Symbols















Symbol	Description
	Consult user documentation.
	WARNING. RISK OF DANGER.
	WARNING. HAZARDOUS VOLTAGE. Risk of electric shock.
	WARNING. LASER RADIATION. Risk of eye damage.
	Connected to ac power. Battery removed.
	Battery status. Battery charging when animated.
	On/Off
	Conforms to European Union directives.
	Certified by CSA Group to North American safety standards.
	Conforms to relevant Australian Safety and EMC standards.
	Conforms to relevant South Korean EMC standards.
	Conforms to the Appliance Efficiency Regulation (California Code of Regulations, Title 20, Sections 1601 through 1608), for small battery charging systems.

Table 1. Symbols (cont.)

Symbol	Description
	Japan Quality Association
	This Product contains a lithium-ion battery. Do not mix with the solid waste stream. Spent batteries should be disposed of by a qualified recycler or hazardous materials handler per local regulations. Contact your authorized Fluke Service Center for recycling information.
	This product complies with the WEEE Directive marking requirements. The affixed label indicates that you must not discard this electrical/electronic product in domestic household waste. Product Category: With reference to the equipment types in the WEEE Directive Annex I, this product is classed as category 9 "Monitoring and Control Instrumentation" product. Do not dispose of this product as unsorted municipal waste.
	Indicates a Class 2 laser. DO NOT STARE INTO BEAM The following text may appear with the symbol on the product label: "IEC/EN 60825-1:2014. Complies with 21 CFR 1040.10 and 1040.11 except for deviations pursuant to Laser Notice 50, dated June 24, 2007." In addition, the following pattern on the label will indicate wavelength and optical power: $\lambda = xxxnm, x.xxmW$.

Product Familiarization

The manual explains features for multiple models. Because models have different features, not all of the information in the manual may apply to your Imager. Use Table 2 to identify the features of your Imager.

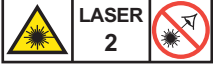
Features

Table 2 lists the features of the Imager.

Table 2. Features

Feature	TiX500	TiX501	TiX520	TiX560	TiX580
Focus/Image Enhancement					
Advanced manual focus	●	●	●	●	●
LaserSharp® Auto Focus System	●	●	●	●	●
Filter mode			●	●	●
MultiSharp™ Focus				●	●
SuperResolution™				●	●

Table 2. Features

Feature	TiX500	TiX501	TiX520	TiX560	TiX580
Digital Zoom					
2X	●	●	●	●	●
4X	●		●	●	●
8X				●	●
IR-Fusion® Technology					
Visible	●	●	●		●
Picture-in-Picture (PIP)	●	●	●	●	●
Full screen IR Autoblend™ (Preset percentage selection)	●		●		
Autoblend™ (Continuously variable allows for 100 % visible mode)		●	●	●	●
Image annotations					
IR-PhotoNotes™	●	●	●	●	●
Audio (Voice)	●	●	●	●	●
Text	●	●	●	●	●
Auto Capture					
Wireless connectivity					
WiFi™	●	●	●	●	●
Bluetooth®	●	●	●	●	●
Fluke Connect®	●	●	●	●	●
HDMI® connectivity					
	●	●	●	●	●
SmartView® software					
Stream video (remote display)	●	●	●	●	●
Remote operation of Imager			●	●	●

Controls

Table 3 shows the connections of the Imager.

Table 3. Connections

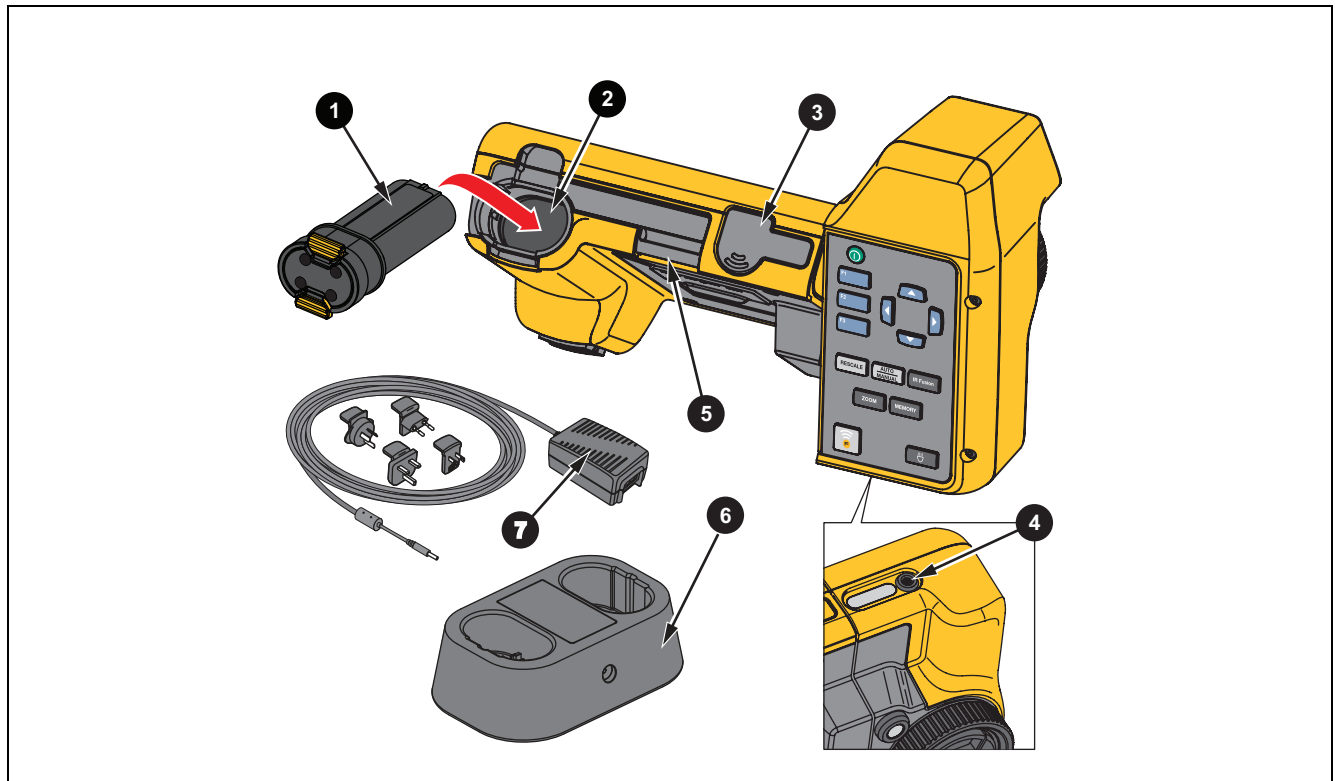

Item	Description	Item	Description
1	Lithium-ion Smart Battery	5	Anchor for Neck Strap
2	Smart Battery Port	6	2-Bay Battery Charging Base
3	Micro SD Memory Card Slot	7	AC Power Supply with Universal Adapters
4	Tripod Mount		

Table 4 shows the front of the Product.

Table 4. Front

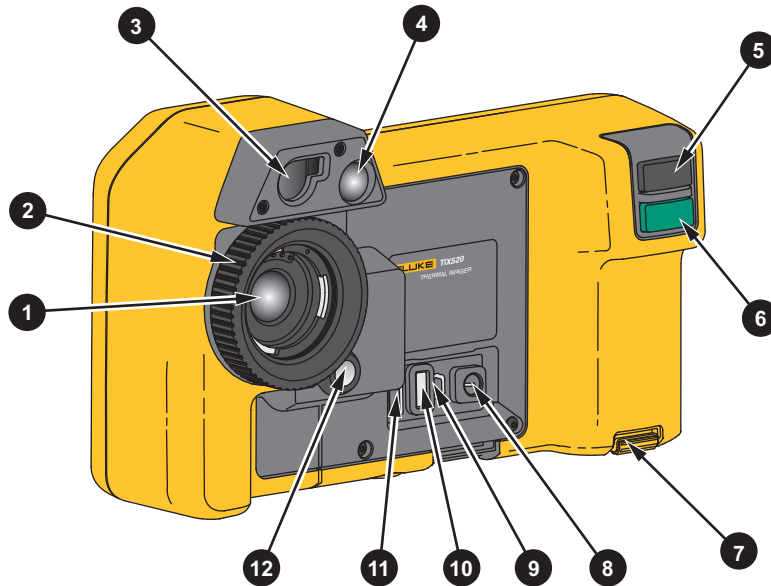

Item	Description	Item	Description
1	Infrared Camera Lens	7	Hand Strap Anchor
2	Manual Focus Control	8	AC Adapter/Charger Input Terminal
3	Laser Pointer/Distance Finder	9	USB Cable Connection
4	Visual Light Camera Lens	10	USB Storage Device Connection
5	Laser Distance Finder Button	11	HDMI Connection
6	Image Capture Button	12	LED Torch/Flashlight

Table 5 shows the back of the Product.

Table 5. Back

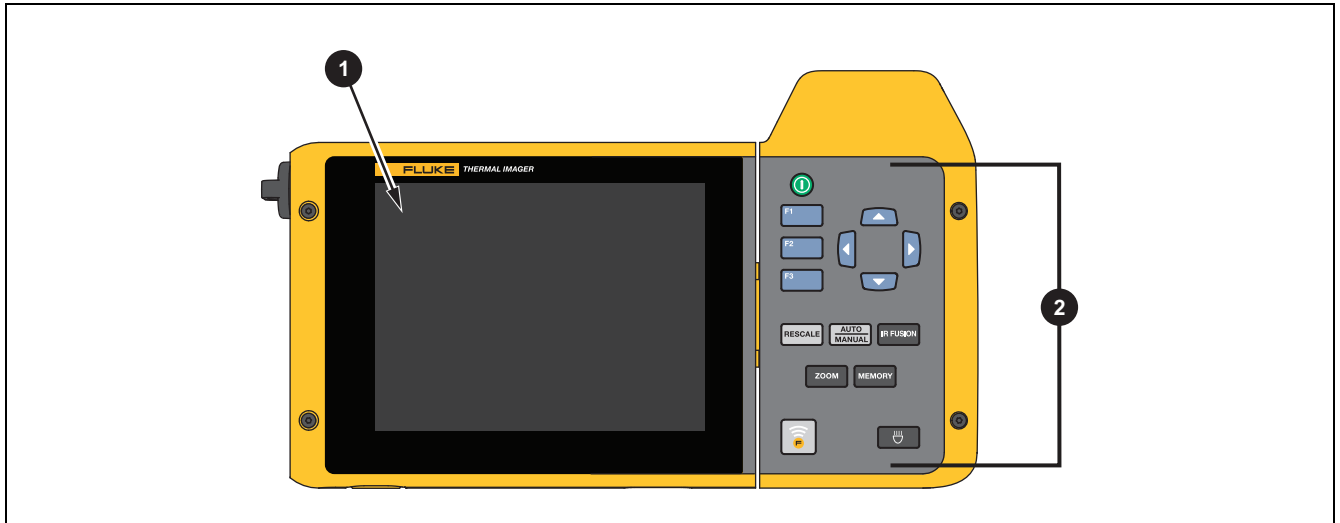

Item	Description	Item	Description
1	LCD Touch Screen (display)	2	Control Panel

Touch Screen

The touch screen is a shortcut to the most used settings. To change parameters or select functions and options, touch a target on the display.

The touch screen has a backlight for work in dimly lit spaces. Table 6 shows the location of each touch target. When not in a menu, double tap on the display to capture an image.

Table 6. Touch Targets

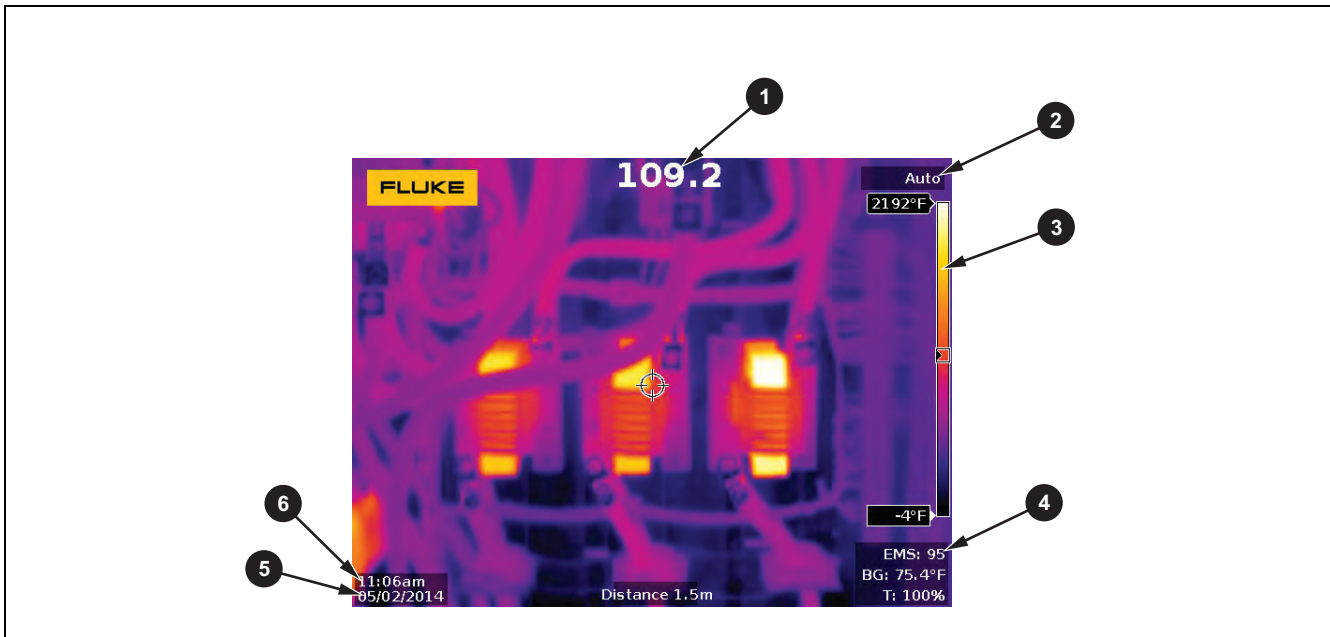













Item	Description	Item	Description
1	Opens the Temperature Unit menu	4	Opens the Measurement menu
2	Toggles Manual/Auto Level and Span	5	Opens the Date menu
3	Opens the Palette menu	6	Opens the Time menu

Control Panel

The control panel is used to change parameters or select functions and options. Table 7 lists the functions of the buttons on the Control Panel.

Table 7. Control Panel

Button	Description
	Push to turn On/Off.
	Within a submenu, push to save the change and go back to the live view.
	Push to open the primary menu. Within a submenu, push to either save the change and go back to the previous menu or to perform the function listed on the submenu key.
	Within a submenu, push to either cancel the change and go back to the live view or to perform the function listed on the submenu key.
	Push to move the cursor and select an option. In live Manual Mode, push to adjust Level and Span.
	Push to open the IR-Fusion Menu
	Push to toggle between Manual/Auto Level and Span.
	Push to open the Internal Image Memory
	Push to turn on the LED Torch/Flashlight
	Push to Zoom In/Zoom Out
	Push to open the Fluke Connect Menu
	Push to automatically rescale the level and span for objects in the thermal field of view. Use to operate the Imager in a semi-automatic mode if manual fine adjustment of level and span is not necessary.

Basic Operation

Turn On and Off the Imager

Before you use the Imager for the first time, charge the battery for a minimum of two and one-half hours. See *Charge Batteries*.

To turn on or turn off the Imager, push and hold  for 2 seconds.

To maximize the life of the battery, use the Power Save and Auto Off features. See Table 14 for more information about how to set these features.

Note

All thermal imagers need sufficient warm-up time for accurate temperature measurements and best image quality. Warm-up time can vary by model and environmental conditions. Although most imagers are fully warmed up in 3 minutes to 5 minutes, wait a minimum of 10 minutes if the most accurate temperature measurement is important to your application. When you move an imager between environments with large differences in ambient temperature, allow for additional adjustment time.

Focus

Correct focus makes sure that the infrared energy is correctly directed onto the pixels of the detector. Without correct focus, the thermal image can be blurry and the radiometric data may be inaccurate. Out-of-focus infrared images are frequently unusable or of little value.

To focus with the advanced manual focus system, rotate the Manual Focus Control until the inspection object is in proper focus. Use the advanced manual focus system as an override to the LaserSharp Auto Focus System. See *LaserSharp Auto Focus System*.

Capture Image

To capture an image:

1. Focus on a target.
2. Push and release the **Image Capture** button or double tap on the display to capture and freeze the image.

The image is in the memory buffer for you to save or edit the image. To edit an image, see *Edit Image*.

Depending on the selected file format settings, the Imager shows the captured image and a menu bar. The menu bar shows the available options.

Note

*MultiSharp Focus captures and freezes images differently. See *MultiSharp Focus*.*

Save Image

To save an image as a data file:

1. Capture an image.



The image is in the memory buffer for you to save or edit the image.

2. Push **F1** to save the image as a file and go back to the live view.

Menus

Use the menus to change and view settings.

To change settings:

1. Push / to select an option.
2. Push  to set the option.

The primary, secondary, and option menus close 10 seconds after the last push of a function button. The option selection menu stays open until you make the selection, go up a menu level, or cancel the action.

Table 8 lists the secondary menus.

Table 8. Primary Menu

Secondary Menu	Description
Measurement	Set the calculation and display of radiometric temperature measurement data related to the thermal images.
Image	Set features used to show infrared images on the display and in some saved image and video files.
Camera	Set options for secondary camera features.
Memory	Select to review and delete captured images and videos.
Fluke Connect	Select to pair the Imager to the Fluke Connect app on a mobile device or to other Fluke Connect tools. <i>Note</i> <i>The Fluke Connect system is not available in all countries.</i>
Settings	Change user preferences and to view information about the Imager.

Measurement Menu

Table 9 lists the options in the Measurement menu.

Table 9. Measurement Menu

Option Menu	Option	Description
Range	<options>	Select the temperature range from one of the preset measurement ranges or to a fully automatic range.
Set Level/Span	Auto	Sets the Level/Span to adjust automatically or manually.
	Manual	
	Set Level/Span	With Level/Span set to Manual , changes the Level/Span. See <i>Level/Span</i> .
Line Temp	<options>	Turns on/off the Line Temp.
Emissivity	Adjust Number	Sets a custom emissivity value when a value from the standard emissivity table is not appropriate for the measurement. See <i>Emissivity Adjustment</i> .
	Select Table	Select an emissivity value from a list of common materials. See <i>Emissivity Adjustment</i> .
Background	<options>	<p>Changes the background temperature to compensate for reflected background temperature.</p> <p>Very hot objects or very cold objects can affect the apparent temperature and measurement accuracy of the target, especially when surface emissivity is low. Adjust the reflected background temperature to improve the accuracy of the measurement.</p> <p style="text-align: center;"><i>Note</i></p> <p style="text-align: center;"><i>If Display is set to Display All, the background temperature shows as BG = xx.x on the display.</i></p>

Table 9. Measurement Menu (cont.)

Option Menu	Option	Description
Transmission	<options>	<p>Changes the transmission percentage of the infrared-transparent window (IR window).</p> <p>When you do infrared inspections through IR windows, not all of the infrared energy emitted from the target is transmitted through the optical material in the window. If you know the transmission percentage of the window, adjust the transmission percentage in the Imager or in SmartView software to improve the accuracy of the measurement.</p> <p style="text-align: center;"><i>Note</i></p> <p style="text-align: center;"><i>If Display is set to Display All, the transmission correction shows as t = xxx% on the display.</i></p>
Spot Temp	Hot	Select to view and turn on/off either the hot or cold spot indicator on the display.
	Cold	The Spot Temperatures are floating HI and LO temperature indicators that move on the display as the temperature measurements of the image fluctuate.
Spot Markers	All Off	Turns off fixed-temperature spot markers.
	<options>	Select the number of fixed-temperature spot markers to use to highlight a region before you take an image. See <i>Spot Markers</i> .
Spot Box	On	Turns on/off a temperature measurement zone (box) that centers on a target.
	Off	
	Set Size	With Spot Box set to On , changes the size of the Spot Box. See <i>Spot Box</i> .
	Set Position	With Spot Box set to On , changes the position of the Spot Box. See <i>Spot Box</i> .

Level/Span

Level and Span are values within the total range of temperature set in **Range**. Level is the temperature level to view within the total range of temperatures. Span is the span of temperatures to view within the total range of temperatures. See Table 10.



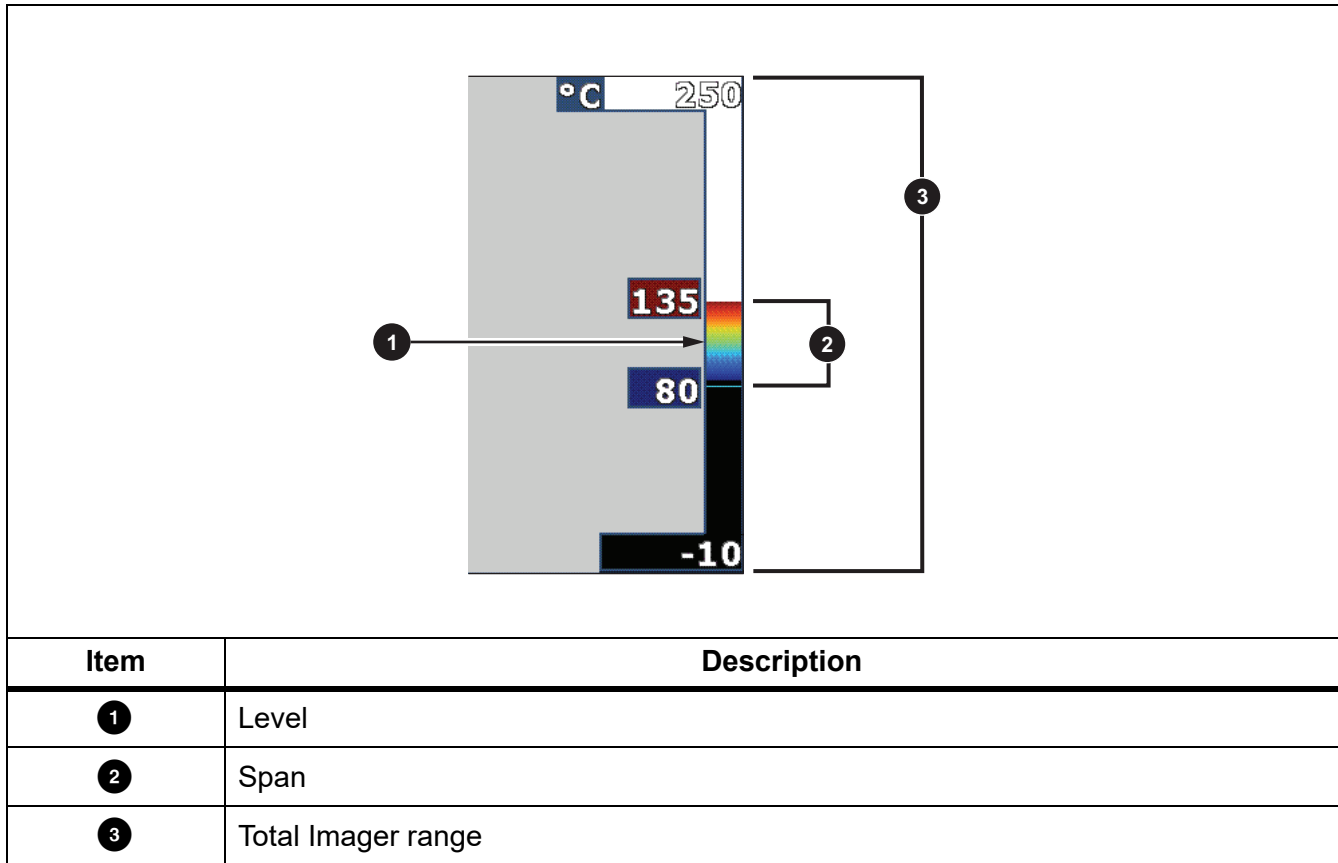

Table 10. Level and Span Settings



In automatic Level/Span mode, the Imager sets **Level/Span** based on the temperatures set in **Range**.

When the **Range** of the Imager is set to one the preset measurement ranges and **Level/Span** is set to **Manual**, the level setting moves the thermal span up or down within the total temperature range.

To change the Level/Span:

1. Select **Measurement > Level/Span > Manual**.
2. Select **Set Level/Span**.
3. Push:
 -  to decrease the temperature span.
 -  to increase the temperature span.
 -  to move the span to a higher temperature level.
 -  to move the span to a lower temperature level.

The scale along the right side of the display shows the thermal span increasing or decreasing in size and shows the span as it moves to different levels within the total range. See Table 10.

See *Detailed Specifications* for more information about the minimum span.

Note

The Imager always powers up in the same Level/Span mode, Auto or Manual, as when the Imager was powered down.

Emissivity Adjustment

All objects radiate infrared energy. The actual surface temperature and emissivity of the target affects the quantity of energy radiated. The Imager senses the infrared energy from the surface of the target and uses the data to calculate an estimated temperature value. Many common materials such as wood, water, skin, cloth, and painted surfaces, including metal, radiate energy well and have a high emissivity factor of $\geq 90\%$ (or 0.90). The Imager measures temperatures accurately on targets with a high emissivity.

Shiny surfaces or unpainted metals do not radiate energy well and have a low emissivity factor of < 0.60 . For the Imager to calculate a more accurate estimate of the actual temperature of targets with a low emissivity, adjust the emissivity setting.

Warning

To prevent personal injury, see emissivity information for actual temperatures. Reflective objects result in lower than actual temperature measurements. These objects pose a burn hazard.

Set emissivity as a direct value or from a list of emissivity values for some common materials. If the emissivity value is < 0.60 , a caution shows on the display.

Note

Surfaces with an emissivity of <0.60 make it difficult to determine reliable and consistent actual temperatures. The lower the emissivity is the greater the potential of error is when the Imager calculates the temperature measurement because more of the energy reaching the camera is specified as background temperature. This is also true even when adjustments to the emissivity and reflected background adjustments are performed properly.

Spot Markers





Use fixed-temperature spot markers to highlight a region on the display before you save an image.

To set a marker:

1. Select **Measurement > Markers**.
2. Select an option.
3. Push **F1** to set the marker option and go to the Move Marker display.

The Move Marker icon shows on the display and the labels on the function buttons change to **Done**, **Next**, and **Cancel**.

To change the marker position on the display:

1. Push     to move the marker location on the image.
2. Push **F2** to select the next marker.
3. Repeat for the rest of the markers.
4. Push **F1** when done.





Spot Box

Use the Spot Box feature to adjust a temperature measurement zone (box) to center on the target. This zone expands and contracts to different levels within the infrared image. The zone shows an approximate maximum (MAX), average (AVG), and minimum (MIN) temperature measurement in that area.

Note

When using the Spot Box, the level and span of the Imager adjusts to the thermal scene within the Spot Box.

To set the size of the Spot Box when Spot Box is set to **On**:

1. Select **Measurement > Spot Box > Set Size**.
2. Push:
 -  to decrease the vertical size of the Spot Box.
 -  to increase the vertical size of the Spot Box.
 -  to decrease the horizontal size of the Spot Box.
 -  to increase the horizontal size of the Spot Box.

When you are satisfied with the size of the Spot Box, push **F1** to set the change and exit the menus or push **F2** to set the change and go back to the previous menu.

To set the position of the Spot Box when Spot Box is set to **On**:





1. Select **Measurement > Spot Box > Set Position**.
2. Push     to move the Spot Box location on the image.
3. When you are satisfied with the position of the Spot Box, push **F1** to set the change and exit the menus or push **F2** to set the change and go back to the previous menu.

Image Menu

Table 11 lists the options in the Image menu.

Table 11. Image Menu

Option Menu	Option	Description
Palette	Standard	Select Standard or Ultra-Contrast palette. The Standard Palettes offer an equal, linear presentation of colors that allow for best presentation of detail.
	Ultra Contrast™	The Ultra Contrast Palettes offer a weighted presentation of colors. Ultra Contrast palettes work best in situations with high thermal contrast for extra color contrast between the high temperatures and low temperatures. <i>See Detailed Specifications.</i>
	Set Palette	Changes the palette color.
	Saturation Colors	Turns on/off Saturation Colors. If Saturation Colors is on, you can set the saturation colors to use.
IR-Fusion	<options>	Select to set the IR-Fusion mode. <i>See Detailed Specifications</i> for modes available based on the model of the Imager. The Imager automatically captures a visible image with every infrared image to show where a potential problem might be. <i>Note</i> <i>The visible image and infrared image can be customized or separated in SmartView and Fluke Connect Software when you use the .is2 or .is3 file format. See File Format.</i>

Table 11. Image Menu (cont.)

Option Menu	Option	Description
Color Alarm	High Alarm OFF	Turns on/off the high-temperature color alarm. The high-temperature color alarm shows a full visible image and only shows infrared information on objects or areas that are above the set apparent temperature level.
	Low Alarm OFF	Turns on/off the low-temperature (or dew point) color alarm. The low-temperature color alarm shows a full visible image and only shows infrared information on objects or areas that are below the set apparent temperature level.
	Set High Alarm	Sets the high apparent temperature level. Requires the High Alarm to be on.
	Set Low Alarm	<p>Sets the low apparent temperature level. Requires the Low Alarm to be on.</p> <p style="text-align: center;"><i>Note</i></p> <p><i>The Imager does not sense ambient or surface dew point level automatically. To use the low-temperature color alarm function as a dew point color alarm, determine and input the surface dew point temperature. The colors presented can help identify areas of concern with possible dew point condensation.</i></p>
	Outside	Shows color isotherms, or infrared information, outside of a set of both high and low limits. Requires High Alarm and Low Alarm to be on and temperature levels for both alarms to be set.
	Inside	Shows color isotherms, or infrared information, inside of a set of both high and low limits. Requires High Alarm and Low Alarm to be on and temperature levels for both alarms to be set.

Table 11. Image Menu (cont.)

Option Menu	Option	Description
Display	<options>	Sets which graphics to view on the display. <i>Note</i> <i>Features that have On/Off controls must be turned on and turned off with those controls.</i>
Image Enhancement	<options>	Sets the advanced image enhancement features of the Imager. See <i>Image Enhancement</i> .
Logo	On	Turns on/off the Fluke logo on the display.
	Off	
	Custom	With SmartView software, upload a custom logo to the Imager from your PC through the USB connection.
Distance	On	Turns on/off the distance units on the display. See <i>Distance</i> .
	Off	
	<options>	Sets units to feet or meters. See <i>Distance</i> .

Image Enhancement

Use the Image Enhancement menu to activate the advanced features of the Imager. Activate either MultiSharp Focus or SuperResolution individually. Use Filter Mode with either MultiSharp Focus or SuperResolution. Table 12 lists the options in the Image Enhancement menu.

Table 12. Image Enhancement Menu

Option	Description
Filter Mode	Combine values from successive frames within a small range of temperatures to reduce pixel noise or thermal sensitivity (NETD) to as low as 30 mK.
Off	Turn off MultiSharp Focus mode or SuperResolution mode and not affect Filter mode.
MultiSharp Focus	MultiSharp Focus captures several images focused on multiple targets that are positioned at different distances from the Imager and creates one image that focuses on the multiple targets at the same time. In MultiSharp Focus mode, you can process the image in the camera or in SmartView software.
MultiSharp Focus (In PC Only)	In MultiSharp Focus (In PC only) mode, the image is not processed on the Imager so you cannot view the image on the Imager. Use SmartView software to view the image on your PC. Set the file format to .is2 for MultiSharp Focus (In PC only) mode to work.
SuperResolution	SuperResolution uses a sensor to capture micro movements to create an image with double the resolution. See <i>Detailed Specifications</i> the resolution available based on the model of the Imager. In SuperResolution mode, the Imager captures the data and processes the image.
SuperResolution (In PC Only)	In SuperResolution (in PC only) mode, the image is not processed on the Imager so you cannot view the image on the Imager. Use SmartView software to view the image on your PC.

MultiSharp Focus

MultiSharp Focus captures several images focused on multiple targets that are positioned at different distances from the Imager and creates one image that focuses on the multiple targets at the same time.

Note

The minimum focus distance with MultiSharp Focus and a standard lens is 15 cm (6 inches). For optimum performance, position the camera ≥ 23 cm (9 inches) from the closest target. MultiSharp Focus also works with all compatible lenses.

To use:

1. Point the Imager at the target.
2. Capture an image. Hold the Imager still while it captures the images.
Saving... shows on the display for ~2 seconds for a 60 Hz model or 5 seconds for a 9 Hz model.
3. When **Saving...** no longer shows on the display, you can move the Imager. If necessary, use a tripod to stabilize the Imager while the images save.
 - In MultiSharp Focus mode, the Imager collects the images in the Imager and shows the focused image on the display in ~8 seconds for a 60 Hz model or ~15 seconds for a 9 Hz model.

Confirm the image on the display is what you need. If possible, process the images on the Imager.

- In MultiSharp Focus (In PC only) mode, the Imager collects the images in a single file and shows the image on the display as it appears before you capture the image (~2 seconds for a 60 Hz model or ~5 seconds for a 9 Hz model).

In MultiSharp Focus (In PC only) Mode, you cannot view the focused image on the Imager. If possible, download, process, and view the image(s) on your computer while you are at the job site. To view the focused image, open the image with SmartView software.

Note

Some targets have abnormal thermal characteristics that can cause the MultiSharp Focus algorithm to fail. If MultiSharp Focus mode does not capture a clear image, use LaserSharp Auto Focus or Advanced manual focus.

SuperResolution

SuperResolution uses a sensor to capture micro movements to create an image with double the resolution. See *Detailed Specifications* for the resolution available based on the model of the Imager.

To use:

1. Capture an image.
2. Hold the Imager still for ~1 second.
 - In SuperResolution mode, the Imager captures the data and processes the image. The image shows on the display of the Imager in ~18 seconds.
 - In SuperResolution (in PC only) mode, the image is not processed on the Imager so you cannot view the image on the Imager. Use SmartView software to view the image on your PC.

Distance

Use the **Laser Pointer/Distance Finder** to measure the distance, up to 30 meters, from the Imager to a target. You can choose to show the distance on the display in feet or meters. The distance is saved as part of the image.

Warning

To prevent eye damage and personal injury:

- **Do not look into the laser. Do not point the laser directly at persons or animals or indirectly off reflective surfaces.**
- **Do not open the Product. The laser beam is dangerous to eyes. Have the Product repaired only through an approved technical site.**

To use the distance measurement feature:

1. Turn on the distance feature and set the units to show on the display.
2. Point the Imager at the target.
3. Push the **Laser Distance Finder** button.
 shows at the top of the display.
4. Position the red laser dot on the target.
5. Release the **Laser Distance Finder** button.

The distance measurement shows on the bottom of the display. The measurement shows as “- - -” when the Imager cannot take a measurement. If this is the case, use a tripod or steady the Imager and retake the measurement. If there is excessive laser movement, an error message shows on the display due to an out of range distance.

Camera Menu

Table 13 lists the options in the Camera menu

Table 13. Camera Menu

Option Menu	Option	Description
LaserSharp Autofocus	On	Turns on LaserSharp Autofocus to automatically focus on a target. See <i>LaserSharp Auto Focus System</i> .
	Off	Turns off LaserSharp Autofocus to use the Advanced manual focus. See <i>LaserSharp Auto Focus System</i> .
Backlight	<options>	Select to set the brightness level of the display.
Torch	--	Turns on/off the built in flashlight.
Video	Video/Audio	Select to record video and audio. <i>Note</i> <i>A Bluetooth headset is required and the radio must be enabled for voice (audio) recording. This feature may not be available in all regions.</i>
	Video ONLY	Select to record video only.
	Record Video	Select to start recording a video. See <i>Video</i> .

Table 13. Camera Menu (cont.)

Option Menu	Option	Description
Auto Capture	Start Capture	Use Auto Capture settings to capture and save an infrared image, or series of images, automatically.
	Interval	Sets the number of hours, minutes, or seconds between image captures. <i>Note</i> <i>The minimum interval available can be affected by the file type and visible light camera settings. Some combinations create larger file sizes that take longer to capture and save and create a higher minimum interval compared to others.</i>
	Image Count	Sets a number of images to capture. Or, select Maximum Memory to capture and save images until the chosen storage memory is full or the battery runs out of power.
	Manual Trigger	Select to automatically capture images when Start Capture is selected.
	Temp Trigger	Select to capture images when a value is above or below a set temperature limit when Start Capture is selected.
	Set Temp Trigger	With Temp Trigger selected, set the temperature and conditions to trigger the auto capture of images.
Wireless	Bluetooth	Uses Bluetooth technology to connect the Imager to a device such as a wireless headset. See <i>Wireless Connectivity</i> .
	WiFi Hotspot	Uses the Imager to create a wireless Hotspot when no WiFi network exists. See <i>Wireless Connectivity</i> .
	WiFi Network	Connects the Imager to a WiFi network so you can sign into your Fluke Connect account on the Imager. See <i>Wireless Connectivity</i> .

LaserSharp Auto Focus System

The **Laser Pointer/Distance Finder** on the Imager is both a sighting aid and a part of the LaserSharp Auto Focus System.

Warning

To prevent eye damage and personal injury, do not look into the laser. Do not point laser directly at persons or animals or indirectly off reflective surfaces.

To use the LaserSharp Auto Focus System:

1. Select **Camera > LaserSharp Auto Focus > On**.
2. Point the Imager at the target.
3. Push and hold the **Laser Distance Finder** button.
 shows at the top of the display.
4. Position the red laser dot on the target.
5. Release the **Laser Distance Finder** button.

The auto focus system automatically focuses on the object.

Note

The laser pointer is aligned parallel to the infrared lens. In AutoBlend Mode, the laser pointer dot is positioned just above the center point marker on the display. It can be easier to use your eyes to locate the visible laser pointer on the target not on the display.

Video

The video controls include stop, rewind, fast forward, and pause/play functions. The thermal scene and complexity of the recorded data affects the amount of time available to record a video.



Note

A Bluetooth headset is required and the radio must be enabled to record audio files. This feature may not be available in all regions.

The video capture format is set in the Settings menu. For more information, see *File Format*.



Record Video

To record:

1. Select **Camera > Video**.
2. Select **Video/Audio** or **Video ONLY**.
3. Touch **Record Video** to set up the Imager to record a video.
 shows in the upper left corner of the display.
4. Push and release the **Image Capture** button to start recording.
 shows in the upper left corner of the display. The elapsed time shows at the bottom of the display.
5. Push and release the **Image Capture** button to stop recording.
6. Push **F2** to end the recording session.
7. Push **F1** to save the video file.

Playback Video

To playback:

1. Open the **Memory** menu.
2. Select a file to playback. All video files show the  icon in the upper right corner of the thumbnail.
3. Push **F1** to set a file for playback.
4. Push **F1** to start the playback. During playback, push  or  for fast forward and rewind.
Push **F1** to continue normal playback.
5. Push **F3** to exit the playback mode.

Wireless Connectivity

The Imager has several wireless connectivity options. Before the first use of the wireless feature, enable the radio. See *Enable the Radio*.

Bluetooth

Use Bluetooth to connect the Imager to a device such as a wireless headset. When Bluetooth is on,  shows in the upper left corner of the display.

To use Bluetooth:

1. Select **Camera > Wireless > Bluetooth > On**.
2. Push **Select** to scan for available Bluetooth devices within the range of the camera.
3. Select a device.
4. Push **F1** to connect to or disconnect from the device.
5. If you are prompted, enter a password.

WiFi Hotspot

Use the Imager to create a wireless Hotspot when no WiFi network exists. You can use the Hotspot to download saved pictures or stream live images from the Imager to a PC with SmartView software or to a mobile device with the Fluke Connect app. See *Stream Live to a PC* and *Fluke Connect Wireless System* for more information. When WiFi Hotspot is on,  shows in the upper left corner of the display.

Note

WiFi is for indoor use only in Kuwait, Chile, and United Arab Emirates.

To create a Hotspot, select **Camera > Wireless > WiFi Hotspot > On**.

To change the settings:

1. Select **Camera > Wireless > WiFi Hotspot > Off**.
2. Select **Settings**.
3. Select an option:
 - **Name (SSID)** to change the SSID
 - **Password** to turn the password on/off or to change the password
 - **Channel** to change the channel
4. Push **F1** to open a keyboard on the display.
5. Use the keyboard to enter the information for the option.

6. Push **F2** to go back.
7. Push **F3** to use the Imager.

WiFi Network

Use the WiFi Network setting to connect the Imager to a WiFi network and to sign into your Fluke Connect account on the Imager. When WiFi Network is on, **WiFi** shows in the upper left corner of the display.

To turn on the WiFi Network feature:

1. Select **Camera > Wireless > WiFi Network > On**.
2. Push **Select** to scan for available networks within range of the Imager.
3. Select a network.
4. Push **F1** to connect to or disconnect from a network.
5. If you are prompted, enter a password.

Sign In

When the Imager is connected to a WiFi network, you can sign into your Fluke Connect account on the Imager and use Fluke Connect Instant Upload. When you use Fluke Connect Instant Upload, the images you take with the Imager automatically upload to your Fluke Connect account in the Fluke Cloud. You can view the images saved in the Fluke Cloud on the Fluke Connect app or the Fluke Connect website without the mobile device and Imager connected to each other.

Note

The Instant Upload feature may not work on all networks or with all devices due to the security profiles on different networks.

To sign in to your Fluke Connect account:

1. Select **Camera > Wireless > Sign In** to open a keyboard on the display.
2. Use the keyboard to enter your user name.
3. Push **F1**.
4. Use the keyboard to enter your password.
5. Push **F1**.

shows on the display.

To sign out:

1. Select **Camera > Wireless > Sign Out**.
2. Push **F1**.

Fluke Connect Wireless System

The Imager supports the Fluke Connect Wireless System. The Fluke Connect system wirelessly connects your Fluke test tools with an app on a mobile device. It shows images from the Imager on your mobile device.

Note

The Fluke Connect system is not available in all countries.

Fluke Connect App

The Fluke Connect app works with Apple and Android products. The app is available for download from the Apple App Store and Google Play.

How to use the Fluke Connect app with the Imager:

1. On the Imager, select **Fluke Connect > Pair to Fluke Connect Mobile App > On**.
2. On the mobile device:
 - a. Go to **Settings > Wi-Fi**.
 - b. Select the Wi-Fi network that begins with **Fluke...**
3. On the Fluke Connect app, select **Thermal Imager** from the list.

You can now take images on the Imager, and they will stream live from the Imager to your mobile device. Live streaming may not be available on all devices. The pictures you take with the Imager are saved on your mobile device and on the Imager.

Note

To save images to the Fluke Connect app, set the file format to .is2 (see File Format) and the image storage to internal memory (see Table 14). Images stored on the SD card or USB storage device may not transfer to the Fluke Connect app.

4. On the Imager, capture an image.
The image is now in the buffer.
5. Push **F1** to save the image and view the image on the phone app.

Fluke Connect Tools

Use the Imager to wirelessly connect to Fluke-Connect-supported tools to:

- View the live measurement of each tool.
- Capture the measurement of each tool in .is2 and .is3 images.

To discover a Fluke Connect-supported tool:

1. Turn on each wireless tool and make sure the wireless feature is enabled. See the documentation of each tool for more information about how to use the tool.
2. Turn on the Imager.
3. Select **Menu > Fluke Connect > Pair to Fluke Connect Tools**.
4. Push **F1** to set selection.

The Fluke Connect button on the wireless tool starts to flash. The Imager starts to scan and presents a list with the ID and name of available tools found within 20 m without obstructions (open air) or within 6.5 m with obstructions (sheetrock wall). You can expect a short delay before the scan is complete.

5. Select the tool name.
6. Push **F1** or touch **Select** to select the tool.
7. Repeat to select each tool.
8. Select **Done**.

The labels change to include an Edit function. By default, the Imager shows and saves the data for the selected tools.





To edit the selection:

1. On the Imager, select the tool name.
2. Push **F1** or touch the **Edit** target. The Edit menu shows the option to show the measurement data and save it with the image to the memory location selected in the Settings menu.

The display on the Imager updates to show the wireless icon and the live measurement for each selected wireless tool.

Memory Menu

Use the Memory menu to review or delete captured images and videos. When additional information has been saved with the file, an icon shows with the preview file. The icons are:

-  IR-PhotoNotes photos
-  Audio
-  Video
-  Text

Review Image

To review an image:

1. Open the **Memory** menu.
2. Select the preview image of the file for review.
3. Push **F2** to review the file.

Edit Image

Before or after you save a file, you can use the Imager to edit or modify the image.

Note

A Bluetooth headset is required and the radio must be enabled to record audio files. This feature may not be available in all regions.

IR-PhotoNotes System

Use the IR-PhotoNotes photo annotation system to capture visible images of various objects, text, or other information that is related to the analysis and reporting of an infrared image. A visible image is a clear digital photo and does not use infrared technology. Examples of possible annotations include motor name plates, printed information or warning signs, larger views of the environment or room, and related equipment or objects. IR-PhotoNotes images are only available in the .is2 file format and are stored in the file so you do not need to collate multiple files at a later time.

To add photos using the IR-PhotoNotes annotation system:

1. With an infrared image in the buffer, push **F2** to open the Edit Image menu.
2. Select **IR-PhotoNotes**.
3. Push **F1** to enter the Picture mode.
4. Capture an image.
5. Capture additional images as required. See *Detailed Specifications* for the maximum number of images that can be stored with IR-PhotoNotes.
6. Push **F1** to save the pictures with the image.

To view an IR-PhotoNote annotation in memory:

1. Open the **Memory** menu.
2. Select a file to view. All files with IR-PhotoNotes annotations show  with the preview file.
3. Push **F1** to view the photo annotations.

Audio

Audio (voice) annotation is only available in the .is2 file format. The audio is stored with the image so you do not need to collate multiple files later.

Note

A Bluetooth headset is required and the radio must be enabled to record audio files. This feature may not be available in all regions.

To add, playback, or edit an audio file:

1. With an image in the buffer, push **F2** to open the Edit Image menu.
2. Select **Add Audio**.
3. Do the corresponding procedure below for the desired action.

Action	Procedure
Add audio file	<ol style="list-style-type: none"> 1. Push F1 to record up to 60 seconds of audio. 2. The display updates to show the recorded time. 3. Push F1 to pause the recorder. 4. Push F2 to stop the recorder. 5. Push F1 to review the audio file, or push F2 to save the audio with the image. <p>The audio file replays through the Bluetooth speaker.</p>
Playback audio file	<ol style="list-style-type: none"> 1. Push F1 to listen to the file. 2. Push F1 again to pause the file. 3. Push F2 twice to exit.
Edit audio file	<ol style="list-style-type: none"> 1. Open the Memory menu. 2. Select a file to view. All files with audio annotations show  with the preview file. 3. Push F2 to open the Edit menu to review the file. The Imager displays Edit or Delete. 4. Select Edit. 5. Push F1 to listen to the file 6. Push F1 again to pause the file 7. Push F1 to append audio to the end of the file, or push F3 to replace the audio file. 8. Do the steps to add an audio file.

Text Notes

Text annotation is only available in the .is2 file format. Text notes are stored with the image so you do not need to collate multiple files later.

To add a text annotation:

1. With an image in the buffer, push **F2** to open the Edit Image menu.
2. Select **Add Text**.
3. Push **F1** to open a keyboard on the display.
4. Use the keyboard to input a message.
5. Push **F1** to save the message.
6. Push **F2** when done.
7. Push **F1** to save the message with the image.

To view a text annotation in memory:

1. Open the **Memory** menu.
2. Select a file to view. All files with text annotations show  with the preview file.
3. Push **F1** to open the Notes menu.
4. Push **F1** to view the text annotation.

Delete Image

To delete images, do the corresponding procedure below for the desired action.

Action	Procedure
Delete one file	<ol style="list-style-type: none"> 1. Open the Memory menu. 2. Select a preview image. 3. Push F2 to open the Edit menu to review the file. 4. Select Selected Image. The Imager displays Edit or Delete. 5. Select Delete. The Imager prompts you to continue or cancel. 6. Push F1 again to delete the file.
Delete all files	<ol style="list-style-type: none"> 1. Open the Memory menu. 2. Push F2 to open the Edit menu to review the file. 3. Select All Images. The Imager prompts you to continue or cancel. 4. Push F1 to delete all the files from the memory.

Settings Menu

Table 14 lists the options in the Settings menu.

Table 14. Settings Menu

Option Menu	Option	Description
File Format	Image Format	Sets the file type to save images and videos to and to set the megapixels to use for the visual light camera. See <i>File Format</i> .
	Video Format	
Units	<options>	Sets the temperature units to Celsius or Fahrenheit.
Auto Off	LCD Time Out	Sets the time before the display automatically turns off.
	Power Off	Sets the time before the Imager automatically turns off. <i>Note</i> <i>Auto Off is automatically disabled when the battery is connected to ac power.</i>
Date	<options>	Sets the date format and the date. See <i>Date</i> .
Time	<options>	Sets the time format and the time. See <i>Time</i> .
Language	<options>	Sets the language to use on the display.
Localization	<options>	Sets the decimal separator to comma or decimal point.
Image Storage	<options>	Sets the location to save images: internal memory, micro SD memory card, or USB storage device.
Advanced	Filename Prefix	Changes the default filename that starts with IR_ to a different 3-character prefix with the touch screen keyboard.
	Reset Filename	Resets the file number to 00001.
	Factory Defaults	Erases all user-set preferences and restore the factory default settings.
	Imager Info	View information about the version, certificates, and Open Source Software Licenses of the Imager
	Adjust Parallax	Fine-tunes the parallax adjustment to precisely align the image.

File Format

Select from a list of image and video file formats based on how the end file will be used. Table 15 lists the image file formats. Table 16 lists the video file formats.

Table 15. Image File Formats

File Format	Description
IS2	Saves images as a .is2 file. Choose the .is2 file format when image modification and maximum resolution is needed. The .is2 file format consolidates the infrared image, radiometric temperature data, visible image, voice annotation, and photos from the IR-PhotoNotes photo annotation system into a single file. To customize or separate the visible and infrared images, use SmartView software or the Fluke Connect app.
JPEG	Saves images as a .jpg file. Choose the .jpg file format for images with the smallest file size, where modification is not needed, and image quality and resolution are not as important.
BMP	Saves images as a .bmp file. Choose the .bmp file format when a smaller file size with maximum resolution is needed and image modification is not.
VLCM Resolution	Sets the megapixels (MP) on the visual light camera. <i>Note</i> <i>To use Image Enhancement features, set the VLCM Resolution to 0.3 MP.</i>

Table 16. Video File Formats

File Format	Description
IS3	Saves videos as an .is3 file with radiometric video capture. Choose the .is3 video format when video modification and maximum resolution is needed. To edit the .is3 video file, use SmartView software or the Fluke Connect app.
AVI	Saves videos as an .avi file with .mpeg encoding. Choose the .avi video format when video modification is not required. The file retains the video settings at the time the video was captured and saved.

Date

The date shows as: **MM/DD/YY** or **DD/MM/YY**.

To set the date:

1. Select **Settings > Date**.
2. Select **MM/DD/YY** or **DD/MM/YY**.
3. Push **F1** to set the new format.
4. Select **Set Date**.
5. Push **F1** to open the Set Date menu.
6. Push **▶/◀** to select **Day**, **Month**, or **Year**.
7. Push **▼/▲** to change the day, month, or year.
8. Push **F1** to set the date and exit the menu.

Time

Time shows as: **24 hour** or **12 hour**.

To set the time format:

1. Select **Settings > Time**.
2. Select **24 hour** or **12 hour**.
3. Push **F1** to set the time format.
4. Select **Set Time**.
5. Push **F1** to open the Set Time menu.
6. Push **▶/◀** to select **Hours** or **Minutes**.
7. If you selected the 12 hour format, select **AM** or **PM**.

SmartView Software

SmartView software for a PC is available to use with the Imager and contains features to analyze images, organize data and information, and make professional reports.

Use SmartView software to:

- Review IR-PhotoNotes, audio, and text annotations.
- Export IR and visible images.
- Edit .is2 image files and .is3 video files.
- Enable Bluetooth, WiFi, and Fluke Connect functions.
- Update the firmware for new Imager feature

Download SmartView Software

Go to

1. On the website, follow the instructions to download the software to the PC.
2. On the PC, follow the instructions to install SmartView software. (Administrator privileges are required for the installation.)
3. Restart the PC when installation is complete.

Download Firmware

1. On the PC, open SmartView software.
2. Connect the USB A connector end of the cable into your PC and the USB Micro B connector end into the Imager.

Note

Some imagers have both A and Micro B connector jacks. Make sure to use the Micro B jack on the Imager.

Windows automatically installs the device driver for use with the Imager. SmartView software recognizes the connection with the Imager and  appears on the SmartView software toolbar menu.

3. On the PC, select **Yes** if prompted to download a firmware update file onto the PC.
4. On the camera, once the firmware is downloaded, select **Update Firmware**, to update the firmware in the camera.

To complete the firmware update, the Imager turns off.

5. To use the new firmware, turn on the Imager.

Enable the Radio

In countries with laws and regulations that permit wireless communications, wireless communication protocols are available to expand the capabilities of the Imager. All imagers ship from the factory with the radios disabled.

To enable the radio:

1. On the Imager, select **Camera > Fluke Connect**.
2. On the PC, go to

3. On the website:

- a. Select a language from the drop down box.
- b. Enter your information and the serial number from the display on the Imager. The serial number is case sensitive.
- c. Click on **Submit**.

If the radio is authorized in your country, an authorization code appears on the web page.

Note

If the radio is not yet authorized in your country, Fluke will contact you when the radio is authorized for use in your country.

4. On the Imager,

- a. Push **F1** or tap **Enter Code**.
- b. Type in the authorization code from the website. (The authorization code is not case sensitive.)
- c. Push **F1** or **Done**.

A message appears on the Imager display that shows the wireless communication is enabled.

If a message appears that says the authorization code is invalid:

- Make sure you entered the correct serial number from the Imager into the website.
 - Make sure you entered the correct authorization code from the website into the Imager.
- d. Tap **Ok**.

Streaming Video (Remote Display)

The Imager can stream live infrared and IR-Fusion technology video to a PC that has SmartView software installed, to the Fluke Connect app (where available), or to an HDMI compatible device.

Stream Live to a PC

To stream live to a PC through a USB connection:

1. Install the latest version of the firmware on the Imager. See *Download Firmware*.
2. On the PC, open the SmartView software.

3. Connect the USB A connector end of the cable into your PC and the USB Micro B connector end into the Imager.

Note

Some Imagers have both A and Micro B connector jacks. Make sure to use the Micro B jack on the Imager

 appears on the SmartView software toolbar menu.

4. On the PC, choose **Remote Display** from .

To stream live to a PC, wirelessly:

1. On the Imager, turn on the WiFi Hotspot. See *WiFi Hotspot*.
2. On the PC:
 - a. From the networks screen, select **Fluke-Camera**.

Note

Fluke-Camera is the default name of the Imager. If you changed the name of the Imager, select the new name of the Imager from the networks on the PC.

- b. Open the SmartView software.

 appears on the SmartView software toolbar menu.

- c. Choose **Remote Display** from .

Stream Live with Fluke Connect Software

To stream live with Fluke Connect software, see *Fluke Connect Wireless System*.

Stream Live to an HDMI Device

HDMI (High-Definition Multimedia Interface) is a compact audio/video interface that transfers uncompressed data and compressed/uncompressed digital audio data from the Imager to a compatible HDMI device.

To stream live to an HDMI device:

1. Attach the included HDMI cable to the HDMI port on the Imager.
2. Connect the other end to an HDMI video device.

Remote Control of Imager

Use SmartView software on a PC or the Fluke Connect app on a mobile device to remotely control the Imager.

To remotely control the Imager with a PC:

1. Turn on Remote Display. See *Stream Live to a PC*.
2. In SmartView software, select **SmartView (Camera)** is the default selection).

When in remote control mode, use the SmartView software to control all the menus on the Imager. The menus cannot be changed directly on the Imager.

To remotely control the Imager with the Fluke Connect app:

1. Set up the Fluke Connect system. See *Fluke Connect Wireless System*.
2. On the mobile device, tap on the streaming image.

An option shows to Remote Control the Imager.

3. Select **Yes**.

From the mobile device, you can change the IR-Fusion setting, select Auto Focus to turn on LaserSharp Auto Focus, or tap the green Capture button to take an image. You can change the other menu items on the Imager directly even while the mobile device remotely controls the Imager.

Accessories

Table 17 is a list of the accessories available for the Imager.

Table 17. Accessories

Model	Description	PN
FLK-TI-SBP4	Smart Battery Pack	4597142
FLK-TI-SBC3B	Charging Base/Power Supply with Adapters	4354922
TI-CAR CHARGER	12 V Vehicle Charger Adapter	3039779
FLUKE-TIX5xx	Neck Strap	4574715
FLUKE-TIX5xx	Hand Strap	4574703
FLK-Bluetooth	Bluetooth Headset	4603258
FLK-HDMI Cable	HDMI Cable	4388596
FLK-HDMI Adapter	HDMI Adapter	4613365
BOOK-ITP	Introduction to Thermography Principles	3413459
FLK-LENS/TELE2	2X Telephoto Infrared Lens	4335377
FLK-LENS/WIDE2	Wide-Angle Infrared Lens	4335361
FLK-LENS/4XTELE2	4X Telephoto Infrared Lens	4607058
FLK-LENS/25MAC2	25-Micron Macro Infrared Lens	4607064

Optional Lenses

Use optional telephoto and wide-angle lenses for more applications of infrared inspection work. To install a lens, align the dot on the lens with the dot on the Product. See Figure 1.

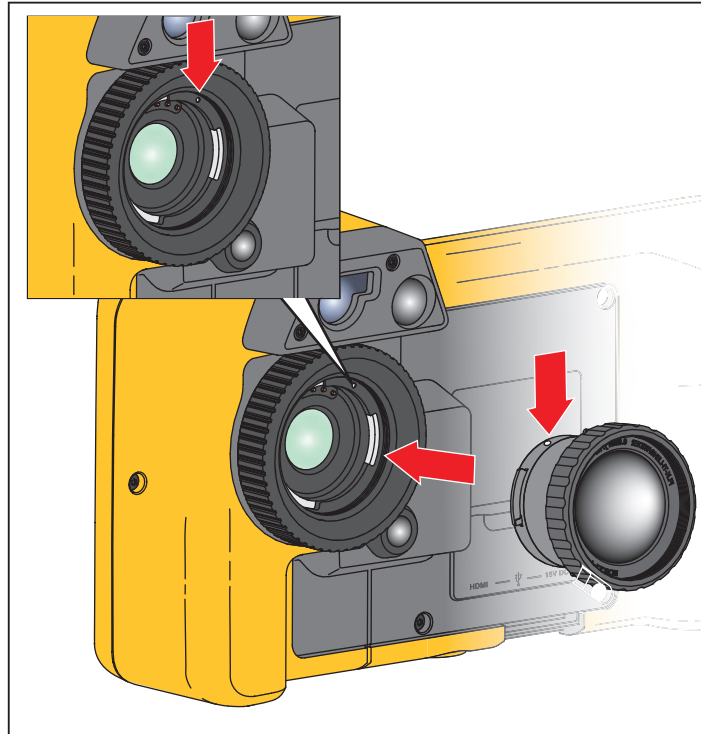

Figure 1. Optional Lens Installation

Neck Strap

Use the neck strap to carry the Imager for an extended period of time. See Figure 2.

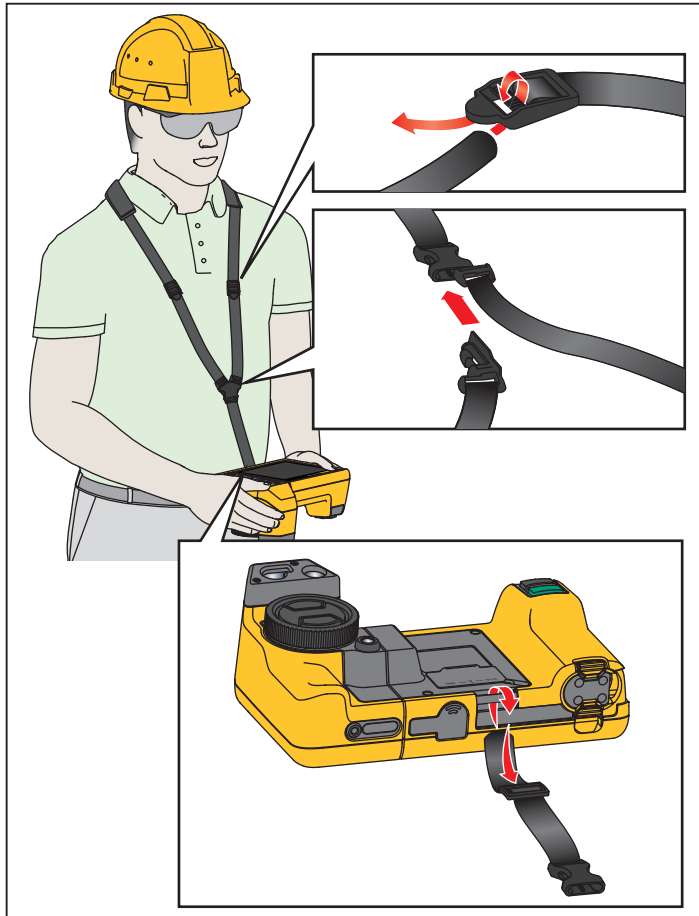

Figure 2. Adjustable Neck Strap

Maintenance

The Imager does not require maintenance.

Warning

To prevent eye damage and personal injury, do not open the Product. The laser beam is dangerous to eyes. Have the Product repaired only through an approved technical site.

Clean the Product

Clean the case with a damp cloth and a weak soap solution. Do not use abrasives, isopropyl alcohol, or solvents to clean the case or lens/window.

Battery Care

⚠ Warning

To prevent personal injury and for safe operation of the Product:

- **Do not put battery cells and battery packs near heat or fire. Do not put in sunlight.**
- **Do not disassemble or crush battery cells and battery packs.**
- **Remove batteries to prevent battery leakage and damage to the Product if it is not used for an extended period.**
- **Connect the battery charger to the mains power outlet before the charger.**
- **Use only Fluke approved power adapters to charge the battery.**
- **Keep cells and battery packs clean and dry. Clean dirty connectors with a dry, clean cloth.**

⚠ Caution

To prevent damage, do not expose Product to heat sources or high-temperature environments such as an unattended vehicle in the sun.

To get the best performance from the lithium-ion battery:

- Do not store the Imager on the charger for more than 24 hours as reduced battery life may result.
- Charge the Imager for a two-hour minimum at six-month intervals for maximum battery life. Without use, the battery will self-discharge in approximately six months. Batteries stored for long periods will need two to ten charging cycles for full capacity.

Charge Batteries

Before you use the Imager for the first time, charge the battery for a minimum of two and one-half hours. The battery status shows on the five-segment charge indicator.

Note

New batteries are not fully charged. Two to ten charge/discharge cycles are necessary before the battery charges to its maximum capacity.

To charge the battery, use one of the options that follow.

Two-Bay Battery Charger Base



1. Connect the ac power supply to the ac wall outlet and connect the dc output to the charger base.
2. Put one or two smart batteries into bays of charger base.
3. Charge batteries until charge LEDs on charger base are a solid green.
4. Remove smart batteries and disconnect the power supply when batteries are fully charged.

AC Power Socket on Imager

1. Connect the ac power adapter into an AC wall outlet and connect the dc output to the Imager's ac power socket.  flashes on the display while the battery charges with the ac power adapter.
2. Charge until the charge indicator on the display does not flash.
3. Disconnect the ac power adapter when the smart battery is fully charged.

Note

Make sure that the Imager is near room temperature before you connect it to the charger. See the charging temperature specification. Do not charge in hot or cold areas. When you charge in extreme temperatures, battery capacity may be decreased.

 shows in the lower left-hand corner of the display when the Imager is connected to ac power and the battery is removed. When the power is off on the Imager and the ac power adapter is connected to the Imager,  flashes in the center of the display to show that the battery charge is in process.

Keep the Imager attached to the charger until the battery condition icon shows a full charge. If you remove the Imager from the charger before a full charge shows, it can have a reduced run-time.

Note

When the battery is connected to ac power or the unit is in video mode, the Sleep Mode/Auto Off feature is disabled automatically.

Optional 12 V Vehicle Charger

1. Connect the 12 V adapter into the 12 V accessory socket of the vehicle.
2. Connect the output to the ac power socket of the Imager.
3. Charge until the indicator shows *full* on the screen.
4. Disconnect the 12 V adapter and Imager when battery is fully charged.

Caution

To prevent damage to the Imager, remove it from the DC car charger before you start or jump start the vehicle.

- Always operate in the specified temperature range.
- Do not store the batteries in extreme cold environments.
- Do not attempt to charge the batteries in extreme cold environments.

Caution

Do not incinerate the Product and/or battery. Go to Fluke's website for recycling information.

Radio Frequency Data

See Table 14 for instructions on how to access digital copies of the Certificate IDs on the Imager.

General Specifications

	TiX500	TiX501	TiX520	TiX560	TiX580
Temperature					
Operating	-10 °C to 50 °C (14 °F to 122 °F)				
Storage	-20 °C to 50 °C (-4 °F to 122 °F) without batteries				
Relative Humidity	10 % to 95 % non-condensing				
Altitude					
Operating	2000 m				
Storage	12 000 m				
Display	14.5 cm (5.7 in) touchscreen diagonal landscape color VGA LCD with backlight				

TiX500, TiX501, TiX520, TiX560, TiX580
Users Manual

	TiX500	TiX501	TiX520	TiX560	TiX580
Power					
Batteries	2 Lithium-ion rechargeable smart battery packs with 5-segment LED display to show charge level.				
Battery Life	3 hours to 4 hours continuous use for each battery pack (Actual life depends on settings and usage.)	2 hours to 3 hours continuous use for each battery pack (Actual life depends on settings and usage.)	3 hours to 4 hours continuous use for each battery pack (Actual life depends on settings and usage.)		2 hours to 3 hours continuous use for each battery pack (Actual life depends on settings and usage.)
Battery Charge Time	2.5 hours to full charge				
AC Battery Charge	Ti SBC3B Two Bay Battery Charger (110 Vac to 220 Vac, 50/60 Hz, included), or in-Imager charging. Ac universal adapters included. Optional 12 V automotive charging adapter.				
AC Operation	AC operation with included power supply: 110 Vac to 220 Vac, 50/60 Hz ac universal adapters included				
Power Save	User-selectable Sleep and Power Off modes				
Safety	IEC 61010-1: Pollution Degree 2				
Wireless Radio					
Frequency	2412 MHz to 2462 MHz				
Output Power	<100 mW				
Electromagnetic Compatibility (EMC)					
International	EN61326-1, CISPR 11: Group 1, Class A <i>Group 1: Equipment has intentionally generated and/or uses conductively-coupled radio frequency energy that is necessary for the internal function of the equipment itself.</i> <i>Class A: Equipment is suitable for use in all establishments other than domestic and those directly connected to a low-voltage power supply network that supplies buildings used for domestic purposes. There may be potential difficulties in ensuring electromagnetic compatibility in other environments due to conducted and radiated disturbances.</i> <i>Caution: This equipment is not intended for use in residential environments and may not provide adequate protection to radio reception in such environments.</i>				
Korea (KCC)	Class A Equipment (Industrial Broadcasting & Communication Equipment) <i>Class A: Equipment meets requirements for industrial electromagnetic wave equipment and the seller or user should take notice of it. This equipment is intended for use in business environments and not to be used in homes.</i>				
USA (FCC)	47 CFR 15 Subpart C Sections 15.207, 15.209, 15.249				
Random Vibration	0.03 g ² /Hz (3.8 g _{RMS} , 5 Hz to 500 Hz, 3 axis, 30 min/axis), 2.5 g, IEC 60068-2-6				
Sinusoidal Vibration	10 Hz to 70.5 Hz (0.3 mm amplitude), 70.5 Hz to 150 Hz (3 g _{PEAK})				
Half-sine Shock	25 G, IEC 68-2-29				
Drop	1 meter (with standard lens)				
Size (H x W x L)	27.3 cm x 15.9 cm x 9.7 cm (10.8 in x 6.3 in x 3.8 in)				
Weight (includes battery)	1.54 kg (3.4 lb)				
Enclosure Rating	IP54				
Calibration Cycle	2 years (assumes normal operation and normal aging)				
Supported Languages	Czech, Dutch, English, Finnish, French, German, Hungarian, Italian, Japanese, Korean, Polish, Portuguese, Russian, Simplified Chinese, Spanish, Swedish, Traditional Chinese, and Turkish				

Detailed Specifications

	TiX500	TiX501	TiX520	TiX560	TiX580
Temperature Measurements					
Temperature Range (not calibrated below -10 °C)	-20 °C to +650 °C	-20 °C to +650 °C	-20 °C to +850 °C	-20 °C to +1200 °C	-20 °C to +1000 °C
Accuracy	±2 °C or 2 % (whichever is greater) at 25 °C ambient				
Imaging Performance					
Image Capture Frequency	9 Hz or 60 Hz refresh rate depending on model variation				
Detector Resolution	320 x 240	640 x 480	320 x 240	320 x 240	640 x 480
SuperResolution	640 x 480	NA	640 x 480	640 x 480	1280 x 960
Thermal Sensitivity (NETD)	≤0.05 °C at 30 °C target temp (50 mK)	≤0.075 °C at 30 °C target temp (75 mK)	≤0.04 °C at 30 °C target temp (40 mK)	≤0.03 °C at 30 °C target temp (30 mK)	≤0.05 °C at 30 °C target temp (50 mK)
Total pixels	76 800	307 200	76 800	76 800	307 200
Infrared spectral band	7.5 μm to 14 μm (long wave)				
Digital Zoom	2X, 4X	2X	2X, 4X	2X, 4X, 8X	2X, 4X, 8X
IR-Fusion Technology					
Autoblend mode	100 %, 75 %, 50 %, 25 % IR plus full visible on camera	Continuously variable	100 %, 75 %, 50 %, 25 % IR plus full visible on camera	Continuously variable	Continuously variable
Picture-in-Picture	100 %, 75 %, 50 %, 25 % IR				
Visual (Visible Light) Camera					
Type	Industrial performance 5.0 MP				
Parallax alignment with standard IR lens	From ~60 cm (~24 in) to infinity				
Standard Infrared Lens					
Field of View (H x V)	24 ° x 17 °	34 ° x 24 °	24 ° x 17 °	24 ° x 17 °	34 ° x 24 °
Spatial Resolution (IFOV)	1.31 mRad	0.93 mRad	1.31 mRad	1.31 mRad	0.93 mRad
Minimum Focus Distance	15 cm (~6 in)				
IR-Fusion Autoblend	Picture-in-Picture and Full screen				
Optional 2X telephoto smart lens					
Field of View (H x V)	12 ° x 9 °	12 ° x 8.5 °	12 ° x 9 °	12 ° x 9 °	12 ° x 8.5 °
Spatial Resolution (IFOV)	0.65 mRad	0.33 mRad	0.65 mRad	0.65 mRad	0.33 mRad
Minimum Focus Distance	45 cm (~18 in)				
IR-Fusion blending	Picture-in-Picture and Full screen				
Optional 4X telephoto smart lens					
Field of View (H x V)	6.0 ° x 4.5 °	NA	6.0 ° x 4.5 °	6.0 ° x 4.5 °	NA
Spatial Resolution (IFOV)	0.33 mRad		0.33 mRad	0.33 mRad	
Minimum Focus Distance	1.5 m (~5 ft)		1.5 m (~5 ft)	1.5 m (~5 ft)	
IR-Fusion blending	Picture-in-Picture and Full screen		Picture-in-Picture and Full screen	Picture-in-Picture and Full screen	

TiX500, TiX501, TiX520, TiX560, TiX580
Users Manual

	TiX500	TiX501	TiX520	TiX560	TiX580
Optional wide-angle smart lens					
Field of View (H x V)	46 ° x 34 °	48 ° x 34 °	46 ° x 34 °	46 ° x 34 °	48 ° x 34 °
Spatial Resolution (IFOV)	2.62 mRad	1.31 mRad	2.62 mRad	2.62 mRad	1.31 mRad
Minimum Focus Distance	15 cm (~6 in)				
IR-Fusion blending	Full screen				
Optional macro smart lens					
Minimum Spot Size	25 μ	NA	25 μ	25 μ	NA
Field of View (H x V)	36.1 ° x 27.1 °		36.1 ° x 27.1 °	36.1 ° x 27.1 °	
Working Distance	~8 mm (0.3 in) to ~14 mm (0.6 in) with optimal at 10 mm (0.4 in)		~8 mm (0.3 in) to ~14 mm (0.6 in) with optimal at 10 mm (0.4 in)	~8 mm (0.3 in) to ~14 mm (0.6 in) with optimal at 10 mm (0.4 in)	
Image Presentation					
Palettes					
Standard	Blue-Red, Grayscale, Inverted Grayscale, High Contrast, Amber, Inverted Amber, Hot Metal, Ironbow				
Ultra Contrast	Blue-Red Ultra, Grayscale Ultra, Inverted Grayscale Ultra, High Contrast Ultra, Amber Ultra, Inverted Amber Ultra, Hot Metal Ultra, Ironbow Ultra				
Level and Span					
Smooth Auto-Scaling and Manual scaling of level and span					
Fast auto toggle between manual and auto modes					
Fast auto-rescale in manual mode					
Minimum Span (in manual mode)	2.0 °C (3.6 °F)				
Minimum Span (in auto mode)	3.0 °C (5.4 °F)				
Image Capture and Data Storage					
Storage Medium					
Internal Flash Memory	4 GB				
Micro SD Memory Card	Includes ≥4 GB memory card to store at least 2000 fully radiometric (.is2) IR and linked IR-PhotoNotes images each with 60 sec voice annotations or 5000 basic (.bmp, .jpg) files. Note Fluke recommends the memory card that is supplied with the Imager or available from Fluke. Fluke does not warrant the use or reliability of aftermarket memory cards of different brands or capacities.				
USB Storage Device	USB port available (USB storage device not included) Note The addition of IR-PhotoNotes or other saved items can vary the total number of images that can be stored in internal memory or on the SD memory card.				
Fluke Cloud Permanent Storage	Yes				

	TiX500	TiX501	TiX520	TiX560	TiX580
File Formats	Non-Radiometric (.bmp, .jpg) or Fully-Radiometric (.is2). No analysis software is required for Non-Radiometric (.bmp, .jpg) files.				
Export File Formats with SmartView Software	.bmp, .gif, .jpg, .png, .tiff				
Memory Review	Thumbnail and full screen review				
Video Recording					
Standard, Non-Radiometric	Viewable through Smart View software, Windows Media Player, Quicktime, and on Imager. H.264 MPEG encoding AVI will also allow voice recording in addition to captured video.				
Recording Speed	24 fps (9 fps for imagers with 9 Hz refresh rate.)				
Radiometric	Viewable on Imager and with SmartView software in proprietary .is3 format. Supports voice recording in addition to captured video.				
Recording Speed	20 fps (9 fps for imagers with 9 Hz refresh rate.)				
IR-PhotoNotes Annotation	5 images	2 images	5 images	5 images	5 images
Audio (Voice) Annotation	Up to 60 sec recording time per image. Reviewable playback on camera. Optional Bluetooth headset available, but not required.				
Text Annotation	Yes				
Streaming Video (Remote Display)					
SmartView Software on PC	USB, WiFi Hotspot, or WiFi Network				
Mobile Device	Fluke Connect app with WiFi Hotspot				
TV Monitor	HDMI				
Remote Control Operation	NA	NA	NA	SmartView software or Fluke Connect app	SmartView software or Fluke Connect app
Wireless Connectivity	PC, mobile device (iOS 4s or newer or Android™ 4.3 or newer), and WiFi to LAN (where available)				
MATLAB® and LabVIEW® tool boxes	NA	Yes	NA	Yes	Yes