

# 3-Axis G-Force Datalogger

## Model VB300

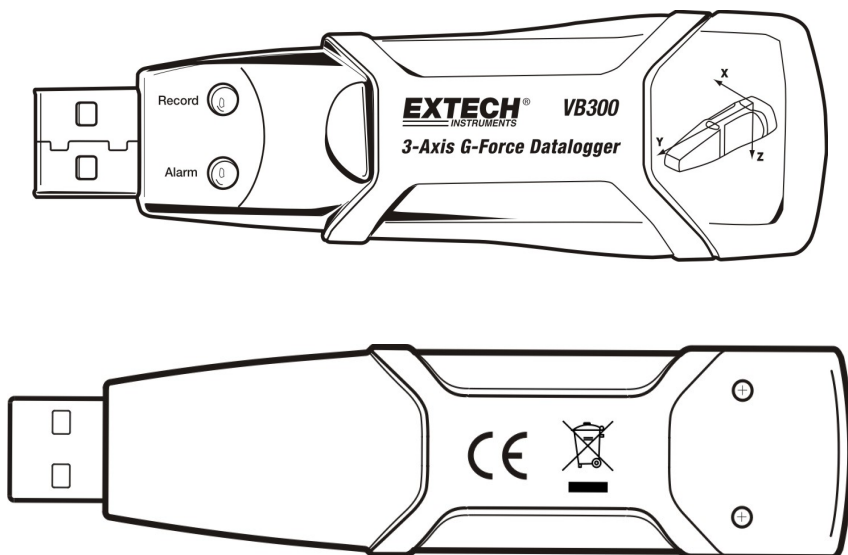

# Introduction

---

Congratulations on your purchase of the VB300 G-Force Datalogger. The Model VB300 can measure and record shock and vibration (acceleration) readings over its  $\pm 18g$  measurement range. This device will record 3-axis g-force and related peaks to provide a history of shock and vibration conditions. The real time clock provides time stamps for all data.

The user can easily configure the logging rate, high/low alarm and start-mode, and download the stored data by plugging the VB300 into a PC's USB port and running the supplied PC software. Measurement data can be plotted, printed and exported for use with other applications such as word processors and spreadsheets. The data logger is supplied with a long-life 1000 hour lithium battery.

The VB300 memory uses a 4MB Flash device that can hold 168042 Normal recordings or 112028 Motion Detection recordings per axis.

This meter is shipped fully tested and calibrated and, with proper use, will provide years of reliable service.

# Features

---

- Records 3-axis g force shock and vibration
- Built-in accelerometer
- Measures static and dynamic acceleration
- Real time operation (time stamped data)
- Normal and Motion detection mode
- Real time FFT frequency analysis
- Manual and Automatic datalogger start modes
- Selectable data sampling rate
- Status Indication via Red and Green LEDs
- USB Interface for Set-up and Data Download
- User-Programmable motion thresholds
- Long battery life - 1000 hours

# Description

## Meter Description

1. USB connector
2. RECORD LED
3. ALARM LED
4. Datalogger Start / Stop Button
5. Axis reference diagram

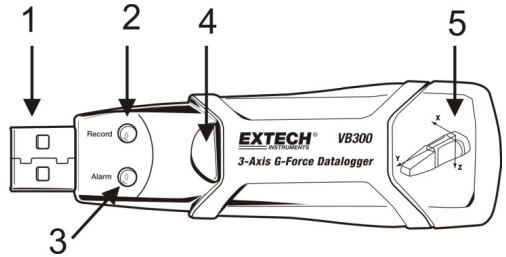

Note: Battery compartment access screws (2) located on rear of unit. Refer to the battery installation section for further details.

## Pedestal Mount Description

1. Mounting screw holes
2. Swivel latch
3. Swivel latch lock
4. Mounting magnets

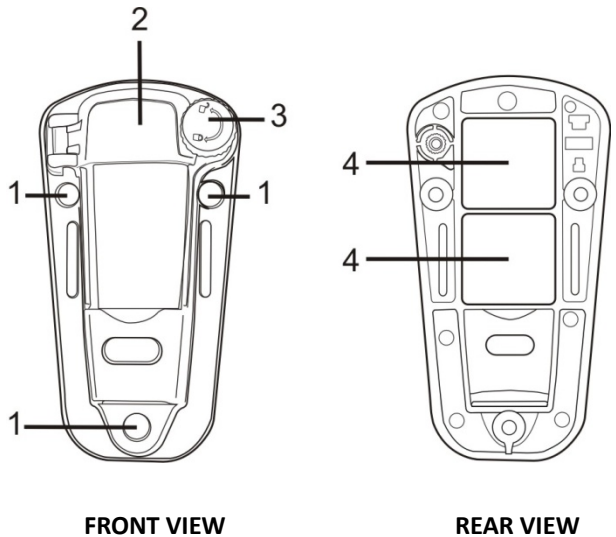

FRONT VIEW









REAR VIEW

## Mounting the VB300

The VB300 fits securely in the supplied mounting pedestal. Unscrew the pedestal latch and snap the VB300 into the pedestal. Secure the latch and follow one of the mounting methods below. There are three mounting methods for affixing the pedestal to the area under test:

1. Magnetically: Powerful magnets are built into the rear of the pedestal
2. Adhesive: Use glue (not supplied) to affix the pedestal to the area under test
3. Screws: Three mounting holes are provided on the pedestal for screw mounting (screws not supplied)

## LED Status Indication

LED		Description	Action
Record	Alarm		
		<b>LEDs not flashing</b> -No logging in process  -No battery found  -Battery completely discharged	- Install battery  - Replace the battery and download the data
		<b>Green single flash every 10 sec.</b> * -Logging, no alarm**	Press and hold the datalogger Start/Stop button on the VB300 until the red LED flashes four times to stop logging
		<b>Red single flash every 30 sec. *</b> -Low Battery	If the unit is datalogging it will stop automatically. The Data will NOT be lost. Replace battery
		<b>Red and Green alternating flashing every 60 seconds;</b> -Datalogger memory is full	-Download data

\* To save power, the VB300's LED flashing cycle can be changed via the supplied software.

\*\* To save power, alarm LEDs for temperature can be disabled via the supplied software.

NOTE: When the battery is low, all operations will be disabled automatically.

NOTE: Logging automatically stops when the battery weakens (logged data will be retained).

# Datalogging Software Program

## INSTALLING THE DATALOGGER SOFTWARE

Install the supplied Windows™ PC Datalogger Software by placing the supplied program disk in the PC's CD-ROM drive. If the installation program does not automatically open and provide on-screen prompts (as shown in diagram below), open and browse the CD-ROM drive, then find and double-click on the SETUP.EXE file included on the program disk. Follow the on-screen prompts as shown below to complete the installation.

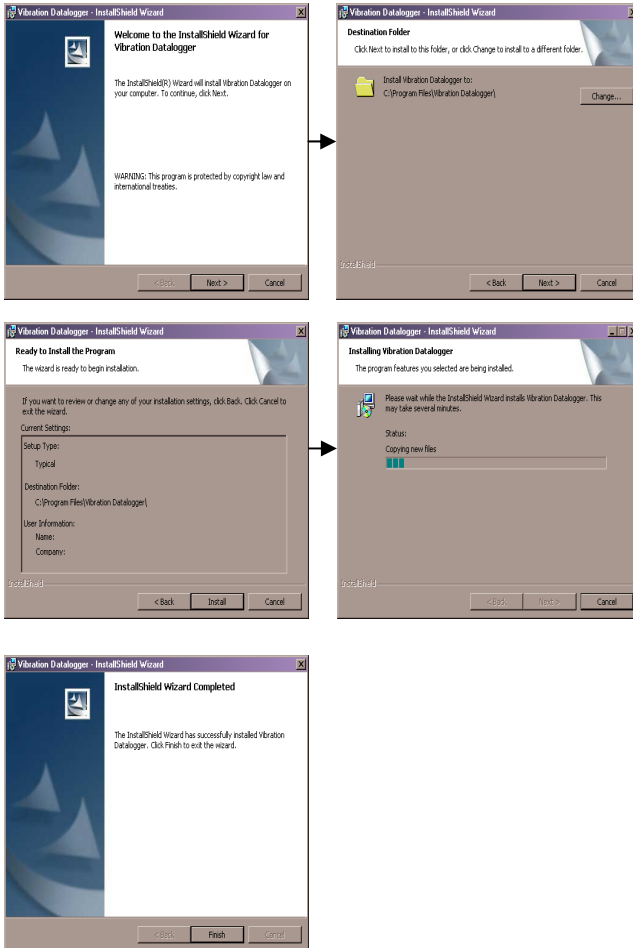

Before running the datalogger software, please connect the VB300 to the PC and install the USB Driver software as described in the next section.

## INSTALLING THE USB DRIVER

The PC will prompt for the USB Driver installation immediately after the main software program is installed. A window similar to the one shown below will appear to prompt for the installation. Simply click INSTALL to continue.

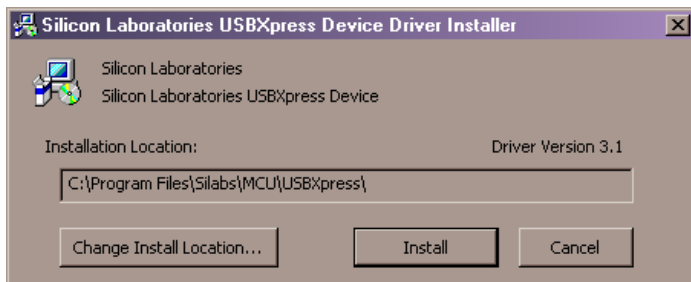

To install the driver manually, plug the VB300 into an available USB port on the PC. If this is the first time that the VB300 is connected to the particular port on the PC, the following screen will appear:



Make sure the program disk is still in the PC CD-ROM drive. Select the 'recommended' installation and follow the on-screen prompts to complete the driver installation. If this is a repeat connection of the VB300 to the USB port, the driver installation process will be automatically skipped.

## RUNNING THE DATALOGGER SOFTWARE

With the VB300 inserted in the PC's USB port, double-click the program icon (located on the desktop) to launch the program. The main software screen will appear.

Instructions for using the Datalogger Software are contained in the HELP Utility available from the HELP menu in the software program. Please read the HELP Utility thoroughly in order to fully understand the software and the related functionality of the VB300.

**Note:** When the VB300 is connected to the USB port, its battery discharges at a higher rate than normal. To conserve battery life, do not leave the VB300 connected to the USB port for a prolonged period of time.

## Basic Datalogger Operation

This section covers only the starting and stopping of the Datalogger's recording functions. All other information is provided in the HELP utility within the software program.

1. Configure the Datalogger's sample rate, motion detection threshold, record mode, LED flash cycle and more using the supplied software program. Refer to the instructions included in the software program's HELP utility to configure the datalogger and to otherwise use the software.
2. If AUTO start is selected in the software, the datalogger will begin logging data the moment the software window is closed. If MANUAL is selected, press and hold the datalogger start/stop button until the green LED flashes; the datalogger LED flashes periodically (flash interval time selectable in software) indicating that the datalogger is recording.
3. To stop datalogging, press and hold the start/stop button while the unit is datalogging. The red LED will quickly flash indicating that datalogging has stopped. Refer to the LED status table earlier in this manual for interpreting the LED flash information.
4. Refer to the software HELP utility for transferring the data from the logger to the PC.

### 1g OFFSET

The axis (or combination of axis) parallel to the earth surface will indicate the 1g force related to gravitational force.

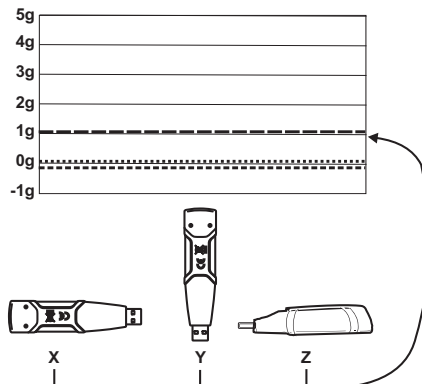



## Specifications

---

<b>Acceleration</b>	Range: $\pm 18g$	Resolution: 0.00625g
<b>Accuracy</b>	$\pm 0.5g$	
<b>Frequency Range</b>	0 to 60Hz	
<b>Datalog Memory</b>	4MB Flash stores 168042 Normal recording records or 112028 Motion Detection records per axis.	
<b>Logging rate</b>	Selectable sampling interval: From 50ms up to 24 hours	
<b>Data format</b>	Time stamped peak acceleration and freefall; Average and Peak Vector sums	
<b>Computer PC interface</b>	USB	
<b>Hardware requirements</b>	8MB RAM; 2MB Hard Drive space for software program; USB jack	
<b>System requirements</b>	Windows™ XP, VISTA, Windows™ 7 (32 and 64 bit)	
<b>Operating temperature</b>	32 to 104°F (0 to 40°C)	
<b>Storage temperature</b>	0 to 140°F (-10 to 60°C)	
<b>Battery type</b>	3.6V Lithium (1/2 AA) 1.0Ah (Saft LS-14250 or equiv)	
<b>Power consumption</b>	1mA (typical, while recording); < 15 $\mu$ A while idling	
<b>Battery life</b>	1000 hours approx.	
<b>Dimensions/Weight</b>	3.7 x 1.1 x 0.8" (95 x 28 x 21mm) / 6oz (172g)	

# Battery Replacement

---

The VB300 does not lose its stored readings when the battery expires or when the battery is replaced. The data logging process will however be stopped and cannot be re-started until the battery has been replaced and the logged data has been downloaded to PC.

The battery life is rated for approx. 1000 hours. If in doubt, replace the battery before logging critical data. Use only 3.6V lithium batteries. Before replacing the battery, remove the datalogger from the PC.

**Note:** When the VB300 is connected to the USB port, its battery discharges at a higher rate than normal. To conserve battery life, do not leave the VB300 connected to the USB port for a prolonged period of time.

1. Remove the two Phillips screws identified with the two smaller arrows in the diagram below.
2. Slide the battery compartment cover in the direction of the larger arrow.
3. Replace the battery with one of the same type (3.6V lithium, ½ AA 1.0Ah, Saft LS-14250 or equiv).
4. Close the battery compartment and tighten with the two screws.

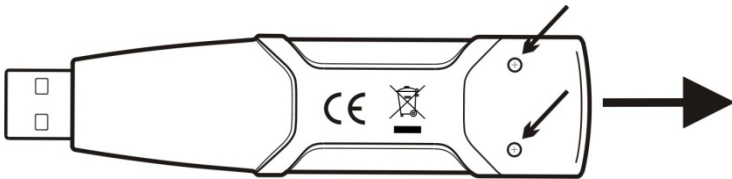

**WARNING:** Handle lithium batteries carefully, observe warnings on battery casing. Dispose of in accordance with local regulations.

## **Warranty**

---

**FLIR Systems, Inc. warrants this Extech Instruments brand device to be free of defects in parts and workmanship for one year from date of shipment (a six month limited warranty applies to sensors and cables). If it should become necessary to return the instrument for service during or beyond the warranty period, contact the Customer Service Department for authorization. Visit the website [www.extech.com](http://www.extech.com) for contact information. A Return Authorization (RA) number must be issued before any product is returned. The sender is responsible for shipping charges, freight, insurance and proper packaging to prevent damage in transit. This warranty does not apply to defects resulting from action of the user such as misuse, improper wiring, operation outside of specification, improper maintenance or repair, or unauthorized modification. FLIR Systems, Inc. specifically disclaims any implied warranties or merchantability or fitness for a specific purpose and will not be liable for any direct, indirect, incidental or consequential damages. FLIR's total liability is limited to repair or replacement of the product. The warranty set forth above is inclusive and no other warranty, whether written or oral, is expressed or implied.**

## **Calibration, Repair, and Customer Care Services**

---

**FLIR Systems, Inc. offers repair and calibration services** for the Extech Instruments products we sell. NIST certification for most products is also provided. Call the Customer Service Department for information on calibration services available for this product. Annual calibrations should be performed to verify meter performance and accuracy. Technical support and general customer service is also provided, refer to the contact information provided below.

**Support Lines: U.S. (877) 439-8324; International: +1 (603) 324-7800**

Technical Support: Option 3; E-mail: [support@extech.com](mailto:support@extech.com)

Repair & Returns: Option 4; E-mail: [repair@extech.com](mailto:repair@extech.com)

Product specifications are subject to change without notice

**Please visit our website for the most up-to-date information**

**[www.extech.com](http://www.extech.com)**

FLIR Commercial Systems, Inc., 9 Townsend West, Nashua, NH 03063 USA

**ISO 9001 Certified**

**Copyright © 2014 FLIR Systems, Inc.**

All rights reserved including the right of reproduction in whole or in part in any form

**[www.extech.com](http://www.extech.com)**

## Garantie

**FLIR Systems, Inc. garantit que cet appareil Extech Instruments est exempt de défauts matériaux et de fabrication pendant un an à partir de la date d'envoi (une garantie limitée de six mois s'applique aux capteurs et aux câbles). Si le renvoi de l'appareil pour réparation devient nécessaire durant ou après la période de garantie, contactez le service client pour autorisation. Pour obtenir les coordonnées, visitez le site Web suivant : [www.extech.com](http://www.extech.com). Un numéro d'autorisation de retour (AR) doit être délivré avant tout retour de produit. L'expéditeur prend à sa charge les frais d'expédition, le fret, l'assurance et l'emballage correct de l'appareil afin de prévenir toute détérioration durant le transport. Cette garantie ne s'applique pas aux dommages imputables à l'utilisateur, tels que l'usage impropre ou abusif, un mauvais câblage, une utilisation non conforme aux spécifications, un entretien ou une réparation incorrecte, ou toute modification non autorisée. FLIR Systems, Inc. déclinera spécifiquement toute garantie ou qualité marchande ou aptitude à l'emploi prévu, et ne sera en aucun cas tenu responsable pour tout dommage conséquent, direct, indirect ou accidentel. La responsabilité totale de FLIR est limitée à la réparation ou au remplacement du produit. La garantie définie ci-dessus est inclusive et aucune autre garantie, écrite ou orale, n'est exprimée ou implicite.**

## Calibrage, réparation et services après-vente

FLIR Systems, Inc. offre des services de calibrage et de réparation pour les produits Extech Instruments que nous commercialisons. Nous fournissons également une certification NIST pour la plupart des produits. Contactez notre service client pour toute information sur les services de calibrage disponibles pour ce produit. Un calibrage doit être effectué chaque année pour vérifier les performances et la précision du mètre. Nous offrons également une assistance technique et un service à la clientèle. Veuillez vous reporter aux coordonnées fournies ci-dessous.

**Lignes d'assistance: États-Unis (877) 439-8324; international: +1 (603) 324-7800**

Service d'assistance technique : Option 3 ; E-mail : [support@extech.com](mailto:support@extech.com)

Réparations et retours : Option 4 ; E-mail : [repair@extech.com](mailto:repair@extech.com)

Les spécifications produit sont sujettes à modifications sans préavis.

**Pour les toutes dernières informations, veuillez visiter notre site Web.**

**[www.extech.com](http://www.extech.com)**

FLIR Commercial Systems, Inc., 9 Townsend West, Nashua, NH 03063 USA

**Certifié ISO 9001**

**Copyright © 2014 FLIR Systems, Inc.**

Tous droits réservés, y compris la reproduction partielle ou totale sous quelque forme que ce soit.

**[www.extech.com](http://www.extech.com)**

## **Garantía**

---

*FLIR Systems, Inc., garantiza este dispositivo marca Extech Instruments para estar libre de defectos en partes o mano de obra durante un año a partir de la fecha de embarque (se aplica una garantía limitada de seis meses para cables y sensores). Si fuera necesario regresar el instrumento para servicio durante o después del periodo de garantía, llame al Departamento de Servicio a Clientes para obtener autorización. Visite [www.extech.com](http://www.extech.com) para Información de contacto. Se debe expedir un número de Autorización de Devolución (AD) antes de regresar cualquier producto. El remitente es responsable de los gastos de embarque, flete, seguro y empaque apropiado para prevenir daños en tránsito. Esta garantía no se aplica a defectos resultantes de las acciones del usuario como el mal uso, alambrado equivocado, operación fuera de las especificaciones, mantenimiento o reparación inadecuada o modificación no autorizada. FLIR Systems, Inc., rechaza específicamente cualesquier garantías implícitas o factibilidad de comercialización o idoneidad para cualquier propósito determinado y no será responsable por cualesquier daños directos, indirectos, incidentales o consecuentes. La responsabilidad total de FLIR está limitada a la reparación o reemplazo del producto. La garantía precedente es inclusiva y no hay otra garantía ya sea escrita u oral, expresa o implícita.*

## **Servicios de calibración, reparación y atención a clientes**

---

**FLIR Systems, Inc., ofrece servicios de reparación y calibración** para los productos que vendemos de Extech Instruments. Además ofrecemos certificación NIST para la mayoría de los productos. Llame al Departamento de Servicio al Cliente para solicitar información de calibración para este producto. Para verificar el funcionamiento y precisión se debe realizar la calibración anual. Además se provee Soporte Técnico y servicios generales al cliente, consulte la información de contacto en seguida.

**Líneas de soporte: EE.UU. (877) 439-8324; Internacional: +1 (603) 324-7800**

Soporte Técnico Opción 3; correo electrónico: [support@extech.com](mailto:support@extech.com)

Reparación / Devoluciones: Opción 4; correo electrónico: [repair@extech.com](mailto:repair@extech.com)

Las especificaciones del producto están sujetas a cambios sin aviso

**Por favor visite nuestra página en Internet para la información más actualizada**

**[www.extech.com](http://www.extech.com)**

FLIR Commercial Systems, Inc., 9 Townsend West, Nashua, NH 03063 USA

***Certificado ISO 9001***

**Copyright © 2014 FLIR Systems, Inc.**

Reservados todos los derechos, incluyendo el derecho de reproducción total o parcial en cualquier medio

**[www.extech.com](http://www.extech.com)**