



---

# USER MANUAL

## Thermal Videoscope Kits

Kit nos. VS290-2x and VS290-3x

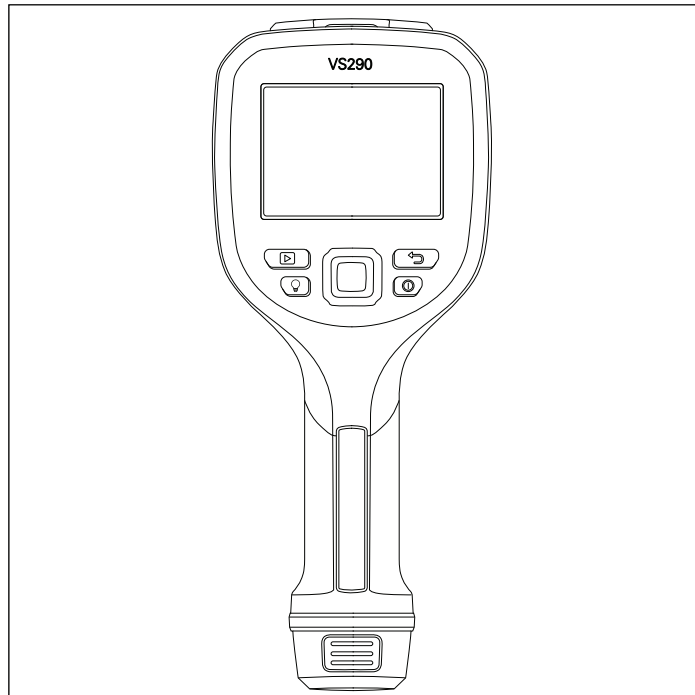

# Table of contents

---

<b>1</b>	<b>Advisories</b> .....	<b>1</b>
1.1	Copyright .....	1
1.2	Quality Assurance .....	1
1.3	Documentation .....	1
1.4	Disposal of Electronic Waste .....	1
<b>2</b>	<b>Introduction</b> .....	<b>2</b>
2.1	Supplied Items and Accessories .....	2
2.2	Product Features .....	3
<b>3</b>	<b>Safety</b> .....	<b>4</b>
3.1	Safety Notes.....	4
<b>4</b>	<b>Product Description</b> .....	<b>6</b>
4.1	Videoscope Display Description.....	6
4.2	Control Buttons .....	7
4.2.1	Power Button .....	7
4.2.2	Return Button.....	7
4.2.3	Gallery Button .....	7
4.2.4	Worklight Button .....	7
4.2.5	Navigation Pad .....	7
4.3	Top Compartment.....	8
4.4	VSC-IR21 Thermal Camera Probe.....	8
4.5	VSC-IR32 Thermal MSX Camera Probe.....	9
4.6	VSC-IR33 Thermal MSX Camera Probe.....	9
4.7	Display Description .....	10
<b>5</b>	<b>Battery Charging and Use</b> .....	<b>12</b>
<b>6</b>	<b>Quick Steps</b> .....	<b>13</b>
<b>7</b>	<b>Programming Menus</b> .....	<b>15</b>
7.1	Basic Navigation .....	15
7.2	Main Menu .....	15
7.3	Image Rotation Menu .....	15
7.4	Image Mode Menu.....	16
7.5	Color Palette Menu .....	17
7.6	Measurements Menu.....	18
7.7	Temperature Scale Menu .....	20
7.8	Settings Menu Overview .....	20
7.9	Settings Menu.....	21
7.9.1	Recording Mode Sub-Menu .....	21

## Table of contents

---

	7.9.2	Measurement Parameters Sub-Menu .....	22
	7.9.3	Save Options Sub-Menu.....	23
	7.9.4	Device Settings Sub-Menu.....	24
<b>8</b>		<b>Taking Measurements .....</b>	<b>29</b>
	8.1	Charge and Install the Battery .....	29
	8.2	Power-up Display Configuration .....	29
	8.3	Programming the Instrument .....	29
	8.4	Positioning the Probe into the Test area .....	30
<b>9</b>		<b>Isothermal Alarms .....</b>	<b>32</b>
	9.1	Isotherms Overview .....	32
	9.2	Isotherm Screen Shots .....	32
<b>10</b>		<b>Working with Images and Video .....</b>	<b>33</b>
	10.1	General SD Card Usage Information .....	33
	10.2	Capturing Images and Video .....	33
	10.3	Viewing Images and Video .....	34
	10.4	Transferring Images and Video .....	34
<b>11</b>		<b>MSX Imaging Technology .....</b>	<b>36</b>
<b>12</b>		<b>Specifications .....</b>	<b>37</b>
<b>13</b>		<b>CUSTOMER SUPPORT .....</b>	<b>40</b>
<b>14</b>		<b>Firmware Updates .....</b>	<b>41</b>
<b>15</b>		<b>Warranty and Product Registration.....</b>	<b>42</b>
	15.1	2–10 Extended Warranty .....	42
	15.2	Product Registration.....	42

# 1 Advisories

---

## 1.1 Copyright

©2021 Teledyne FLIR LLC. All rights reserved worldwide.

No parts of the software including source code may be reproduced, transmitted, transcribed or translated into any language or computer language in any form or by any means, electronic, magnetic, optical, manual or otherwise, without the prior written permission of Teledyne FLIR LLC.

The documentation must not, in whole or part, be copied, photocopied, reproduced, translated or transmitted to any electronic medium or machine-readable form without prior consent, in writing, from Teledyne FLIR LLC. Names and marks appearing on the products herein are either registered trademarks or trademarks of Teledyne FLIR LLC and/or its subsidiaries. All other trademarks, trade names or company names referenced herein are used for identification only and are the property of their respective owners.

## 1.2 Quality Assurance

The Quality Management System under which these products are developed and manufactured has been certified in accordance with the ISO 9001 standard. Teledyne FLIR LLC is committed to a policy of continuous development; therefore, we reserve the right to make changes and improvements on any of the products without prior notice.

## 1.3 Documentation

To access the latest manuals and notifications, go to the Download tab at: [www.teledyneflir.com](#). It only takes a few minutes to register online. In the download area you will also find the latest releases of manuals for our other products, as well as manuals for our historical and obsolete products.

## 1.4 Disposal of Electronic Waste



As with most electronic products, this equipment must be disposed of in an environmentally friendly way, and in accordance with existing regulations for electronic waste. Please contact your Teledyne FLIR LLC representative for more details.



## 2 Introduction

---

Thank you for selecting the VS290–2x or VS290–3x Thermal Videoscope kit. The kit includes one VS290–00 Videoscope Display, accessories, and one of the following camera probes:

- VSC–IR21 Thermal Camera Probe with 19 mm diameter Round Tip (Forward View).
- VSC–IR32 Thermal MSX® CAT IV Camera Probe with Rectangle Tip (Side View).
- VSC–IR33 Thermal MSX® CAT IV Camera Probe with 19 mm diameter Round Tip (Side View).

The Thermal Videoscope kit is the first industrial inspection Videoscope with Thermal, Visual, and MSX technology. It is a rugged, high quality, and reliable visual inspection instrument that improves productivity and reduces diagnostic time for facility diagnostics, utilities, manufacturing, public safety, and inspection service industries.

Please update the VS290–00 Videoscope Display's firmware, as explained in Section 14, before first use and periodically thereafter, to ensure optimum performance.

Please register your purchases and review the product warranty before use, see Section 15.

### 2.1 Supplied Items and Accessories

The kit includes the following:

- Videoscope Display
- Camera probe
- Li ion rechargeable batteries (2)
- Battery charger (two bays)
- AC power supply
- USB-C cable
- SD card
- Software: License card for 'FLIR Thermal Studio Standard', 1 Year Subscription
- Wrist strap
- Hard-shell carry-case for all items
- Printed Quick Start document

## 2 Introduction

---

### 2.2 Product Features

- 160 x 120 IR imaging resolution.
- MSX (Multi-Spectral Dynamic Imaging) on VSC-IR32 and VSC-IR33 probes.
- Thermal IR-only camera on VSC-IR21 probe.
- Probes include flexible points and are low-profile.
- -10°C to 400°C (14°F to 752°F) temperature range.
- 57° x 44° field of view (FOV).
- Automatic hot/cold spotting and Isotherm (color) alarms.
- CAT IV 600 V safety rating (VS290-32 and VS290-33 only).
- IP67 rated camera probe (IP54 rated Videoscope Display).
- LED worklight (VSC-IR32 and VSC-IR33 probes only).
- Longer than five (5) hours of battery operation on one charge.

# 3 Safety

## 3.1 Safety Notes

- Before operating the device, you must read, understand, and follow all instructions, dangers, warnings, cautions, and notes.
- FLIR Systems reserves the right to discontinue models, parts or accessories, and other items, or to change specifications at any time without prior notice.
- This product conforms to UL STD 61010-1 and is certified to CSA STD C22.2, no. 61010-1.

 <b>WARNING</b>
<p>This product is a battery operated digital thermal camera intended for special use. The kit includes the VS290-00 Videoscope Display, camera probe, and accessories as listed in the Specifications section.</p> <p>The VS290-32 and VS290-33 are suitable for use in CAT IV 600 V environments.</p> <p>The VS290-21 is not intended for use in high voltage (&gt; 600 V AC) environments. Personal injury, damage to the camera, and damage to external equipment can result.</p>

 <b>WARNING</b>
<ul style="list-style-type: none"><li>• Do not operate the device if you do not have the correct knowledge. Incorrect operation of the device can cause damage and injury to persons.</li><li>• Do not use the device if it show signs of damage. Injury to persons can occur.</li><li>• Be careful working near voltages &gt; 25 V AC or 35 V DC. There is a risk of shock from these voltages. Injury to persons can occur.</li></ul>

 <b>CAUTION</b>
<p><b>Battery Safety</b></p> <p>Do not incinerate or disassemble batteries. Batteries can explode or otherwise release toxic materials.</p> <p>Do not short circuit batteries, this may cause burns.</p> <p><b>Attention. Ne pas incinérer ni démonter les piles. Les batteries peuvent exploser ou libérer des matières toxiques.</b></p> <p><b>Ne court-circuitiez pas les piles, cela pourrait provoquer des brûlures.</b></p>

**WARNING****FCC Warnings. Applicability: Class B digital devices.**

This equipment has been tested and found to comply with the limits for a Class B digital device, pursuant to Part 15 of the FCC Rules. These limits are designed to provide reasonable protection against harmful interference in a residential installation. This equipment generates, uses and can radiate radio frequency energy and, if not installed and used in accordance with the instructions, may cause harmful interference to radio communications. However, there is no guarantee that interference will not occur in a particular installation. If this equipment does cause harmful interference to radio or television reception, which can be determined by turning the equipment off and on, the user is encouraged to try to correct the interference by one or more of the following measures:

- Reorient or relocate the receiving antenna.
- Increase the separation between the equipment and receiver.
- Connect the equipment into an outlet on a circuit different from that to which the receiver is connected.
- Consult the dealer or an experienced Radio / TV technician for help.

Unlicensed band: This device complies with Part 15 of the FCC Rules. Operation is subject to the following two conditions: (1) this device may not cause harmful interference, and (2) this device must accept any interference received, including interference that may be caused by unintended operation.

(15.21): Changes or modifications to this unit not expressly approved by the party responsible for compliance could void the user authority to operate the equipment.

**CAUTION**

- Do not point the infrared camera at strong energy sources, such as the sun, as this can have an undesirable effect on the camera accuracy and can cause camera damage.
- Use caution when cleaning the camera lens as the lens has a protective coating that is easily damaged.
- Do not use excessive force when cleaning the camera lens. Damage to the protective lens coating can occur.

**NOTE**

The encapsulation rating on the VS290-00 Videoscope Display is only applicable when all the openings are sealed with their correct covers, hatches, or caps. This includes the compartments for data storage, batteries, and connectors.

# 4 Product Description

## 4.1 Videoscope Display Description

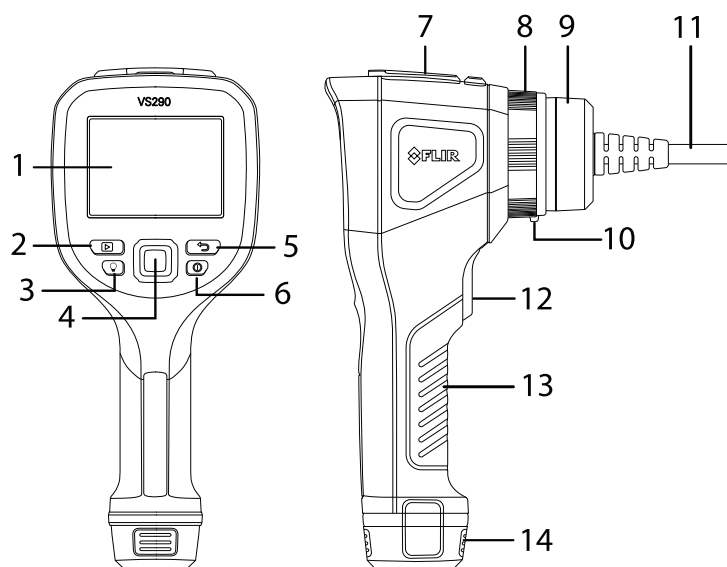

Figure 4.1 VS290-00 Videoscope Description

1. Camera display
2. Image and video Gallery button
3. LED worklight button
4. Navigation pad. Menu button (centre) and navigation buttons (outer ring)
5. Return button (exit a menu)
6. Power button (long press)
7. USB connector and memory card compartment
8. Collar screw locks probe to VS290-00
9. Probe connector
10. Probe release tab
11. Probe
12. Image and video capture trigger
13. Handle grip
14. Battery in battery compartment

## 4 Product Description

---

### 4.2 Control Buttons

The four control buttons and navigation pad are explained below.

#### 4.2.1 Power Button



Long press the power button to switch the instrument ON or OFF.

#### 4.2.2 Return Button



Press the Return button to exit or move backward in the programming menu.

#### 4.2.3 Gallery Button



Press the Gallery button to access the stored images and video. Press the Return button ↶ to exit the gallery.

#### 4.2.4 Worklight Button



Press the Worklight button to switch the probe tip light ON or OFF (not available on VSC-IR21 probe).

#### 4.2.5 Navigation Pad

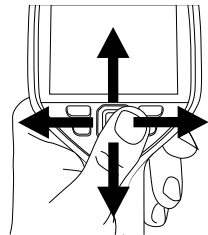

**Figure 4.2** Navigation Pad. Menu button (centre) and outer navigation buttons (left/right, up/down).

Press the centre button to open the main menu and use it in the menus to make selections. Use the outer navigation buttons to move up/down and left/right in the program menus.

## 4 Product Description

### 4.3 Top Compartment

Open the top flap to access the USB connector and the SD card slot.

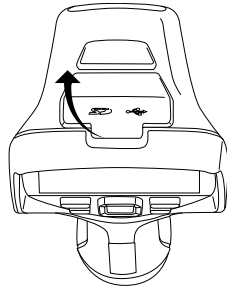

**Figure 4.3** Accessing the USB connector and SD card in the top compartment.

### 4.4 VSC-IR21 Thermal Camera Probe

The VSC-IR21 is an IR-only, general purpose, round forward-looking probe. The VSC-IR21 probe is not intended for use in high voltage (> 600 V AC) environments.

Always update the VS290-00 Videoscope Display's firmware, as explained in Section 14, before connecting a new probe, to ensure optimum performance.

 <b>CAUTION</b>
Ensure that the VS290-00 is powered off before removing or attaching probes. Do not attempt to remove or attach a probe with the VS290-00 powered up.

Note that the release tab (item no. 10 in Figure 4.1) must be pushed to release a probe from the Videoscope display when removing it.

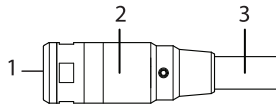

**Figure 4.4** VSC-IR21 camera probe.

1. Thermal camera lens
2. Camera body
3. Probe

## 4 Product Description

### 4.5 VSC-IR32 Thermal MSX Camera Probe

The VSC-IR32 is a thermal MSX, rectangular, side-looking probe. It is suitable for use in CAT IV 600 V environments.

Always update the VS290-00 Videoscope Display's firmware, as explained in Section 14, before connecting a new probe, to ensure optimum performance.

 <b>CAUTION</b>
Ensure that the VS290-00 is powered off before removing or attaching probes. Do not attempt to remove or attach a probe with the VS290-00 powered up.

Note that the release tab (item no. 10 in Figure 4.1) must be pushed to release a probe from the Videoscope display when removing it.

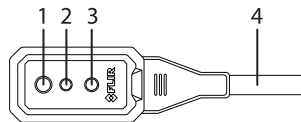



Figure 4.5 VSC-IR32 camera probe.

1. Thermal camera lens
2. Digital camera lens
3. LED worklight
4. Probe

### 4.6 VSC-IR33 Thermal MSX Camera Probe

The VSC-IR33 is a thermal MSX, side-looking, round probe. It is suitable for use in CAT IV 600 V environments.

Always update the VS290-00 Videoscope Display's firmware, as explained in Section 14, before connecting a new probe, to ensure optimum performance.

 <b>CAUTION</b>
Ensure that the VS290-00 is powered off before removing or attaching probes. Do not attempt to remove or attach a probe with the VS290-00 powered up.

Note that the release tab (item no. 10 in Figure 4.1) must be pushed to release a probe from the Videoscope display when removing it.



## 4 Product Description

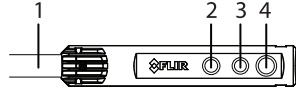

**Figure 4.6** VSC-IR33 camera probe.

1. Probe
2. LED worklight
3. Digital camera lens
4. Thermal camera lens

### 4.7 Display Description

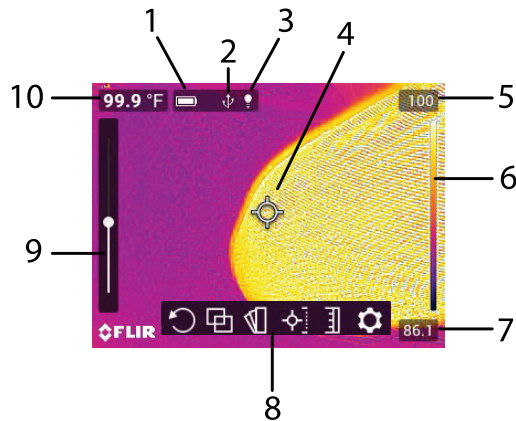

**Figure 4.7** Videoscope display.

1. Battery status
2. USB active
3. Worklight active
4. Cross-hairs. Target a surface spot to measure its temperature. See Section 7.6, *Measurements Menu*, for additional cross-hairs functionality
5. Highest temperature sensed in the current camera image
6. Range of the selected display colour palette. In the Above/Below Alarm Colour modes, alarm alerts are represented here
7. Lowest temperature sensed in the current camera image
8. Main menu icons

#### 4 Product Description

---

9. Thermal MSX alignment sliders. Vertical and horizontal sliders are used to align the super imposed thermal and digital camera images. The horizontal slider is obstructed in the image above  
Note that the VSC-IR21 does not include MSX, digital camera, or worklight features.
10. Temperature reading of targeted spot. In Hot/Cold Spot modes, this area will show the MAX or MIN temperature (see Section 7.6, *Measurements Menu*, for more)

## 5 Battery Charging and Use

---

This kit is supplied with two high capacity batteries, a stand-alone two-bay charger, and an AC adaptor. To charge batteries, place them in the charger, connect the charger bay to the AC adaptor, and then plug the adaptor into an AC receptacle. The LED indicators on the charger flash while a battery is charging and glow steadily when fully charged. It may require up to 2 hours for a full charge if a battery is completely drained.

Once charged, place a charged battery into the battery compartment and long press the power button  to power the instrument. If an error message appears informing that the battery voltage is low, charge the battery immediately.

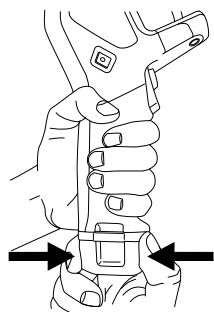

**Figure 5.1** Installing and removing a battery.

## 6 Quick Steps

---

These steps are provided to provide a simple overview. Please read the entire User Manual before putting these devices into professional operation.



### CAUTION

The VS290-32 and VS290-33 are suitable for use in CAT IV 600 V AC environments. The VS290-21 is not intended for use in high voltage (> 600 V AC) environments.

### NOTE

Please update the VS290-00 Videoscope Display's firmware, as explained in Section 14, before first use and periodically thereafter, to ensure optimum performance.

1. Insert a fully charged battery into the VS290-00 handle.
2. If the probe is purchased separately from the Videoscope Display, please connect the probe to the Videoscope Display before proceeding. Ensure that the VS290-00 is powered off before attaching or removing a probe. Note that the release tab (item no. 10 in Figure 4.1) must be pushed to release a probe from the Videoscope display when removing it.
3. Long press the power button  to power up.
4. When powered, the VS290-00 displays a camera image and several function indicators, dependant on the configuration of the instrument.



**Figure 6.1** Viewing a camera image.

## 6 Quick Steps

---

5. Carefully position the probe into the area to be examined and view the camera image on the display. Short press the worklight button  to switch the light on/off (the worklight is not available on the VSC-IR21 probe).



**Figure 6.2** Insert the probe into the test area.

6. To select an image mode, press the Menu button (centre), scroll to the Image Mode icon and press Menu again. Use the navigation buttons to select Thermal MSX, Thermal, or Digital camera; press Menu to confirm. Note that the VSC-IR21 probe does not include MSX, digital camera, or worklight features.
7. The cross-hairs allow you to target and measure the surface temperature of a spot. The measurement is shown digitally (upper left). The thermal scale for the current image is shown on the right edge of the display.
8. To capture an image or to stop/start a video, pull and hold the trigger. Press the Gallery button  to view stored images and videos. Images/videos can be sent to a PC via USB.

# 7 Programming Menus

## 7.1 Basic Navigation

Press the Menu button (centre) to open the main menu and the sub-menus. Use the navigation buttons to scroll left/right and up/down. Use the Menu button (centre) to confirm a selection; press the Return button ↵ to exit a menu.

## 7.2 Main Menu



The main menu options are: 1. Image Rotation, 2. Image Mode, 3. Color, 4. Measurement, 5. Temperature Scale, and 6. Settings.

## 7.3 Image Rotation Menu

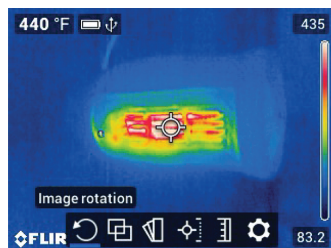

Figure 7.1 Accessing the Image Rotation mode.

Press Menu on the Image Rotation icon and use the navigation buttons to select 90° rotation or horizontal/vertical flip of the camera image. Press Menu to confirm.



Figure 7.2 Selecting 90° Rotation or Vertical/Horizontal Flip.

## 7 Programming Menus

### 7.4 Image Mode Menu

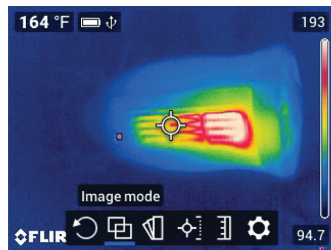

Figure 7.3 Accessing the Image Mode menu.

Press Menu on the Image Mode icon and use the navigation buttons to select: Digital, Thermal, Thermal MSX, or Alignment Distance.

Note that the VSC-IR21 probe does not include MSX, digital camera, or work-light features.

Thermal MSX (Multi-Spectral Dynamic Imaging) is an enhancement that improves image clarity by embossing visual scene details on the thermal image, providing added context to accurately target potential issues. The MSX Alignment Distance option allows you to fine tune the embossed visual scene details using the vertical and horizontal sliders. See Figure 7.5 below.

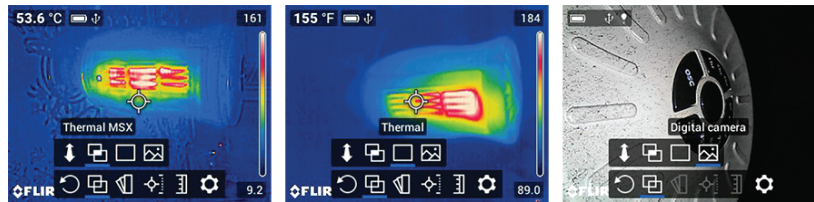

Figure 7.4 Selecting the Thermal MSX, Thermal only, and Digital Camera modes.

## 7 Programming Menus



**Figure 7.5** Select the Thermal MSX mode and then the Alignment Distance option. Use the sliders (left side and bottom of the display) to align the Digital Camera image with the Thermal image. Use the left/right and up/down arrow buttons to make the adjustments.

For best results in darker areas, turn the worklight on when using MSX.

### 7.5 Color Palette Menu

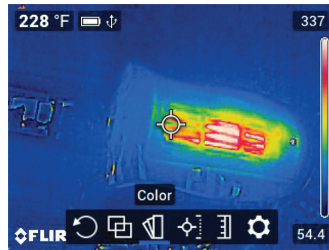

**Figure 7.6** Accessing the Color Palette mode.

To select a display color palette, press Menu on the Color icon and use the navigation arrows to scroll. Press Menu when the desired color palette is selected (Iron, Rainbow, Gray, Above Alarm, or Below Alarm).

In the Above/Below Alarm modes (known as 'Isotherms'), you select a high alarm set point (for Above Alarm mode) and a low alarm set point (for Below Alarm mode). The colorations in the thermal image indicate the sections of the test area that exceeded the set point limit. Use the arrow buttons to set the temperature limits (the set point is shown on the bottom of the display). The vertical colour bar graph on the right side of the display indicates the degree to which the alarm set point is exceeded. See Section 9, *Isothermal Alarms*, for more.



## 7 Programming Menus

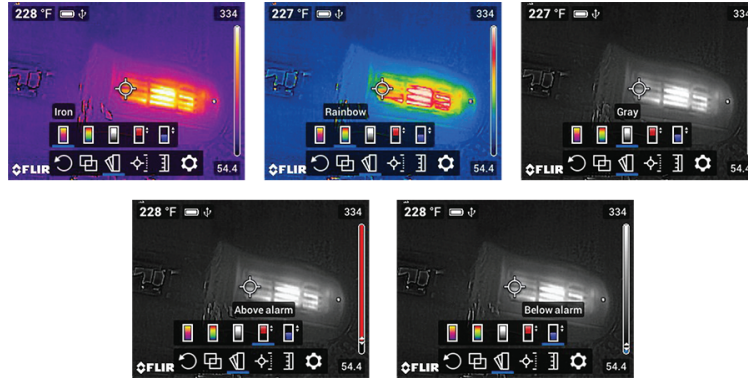

Figure 7.7 Selecting a Color palette or an Isotherm Alarm (Above and Below) mode.

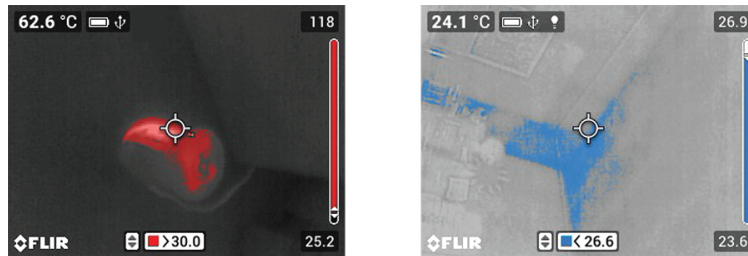

Figure 7.8 Isotherm Alarm examples.

### 7.6 Measurements Menu

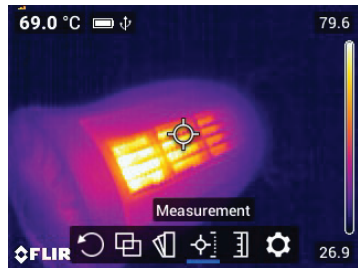





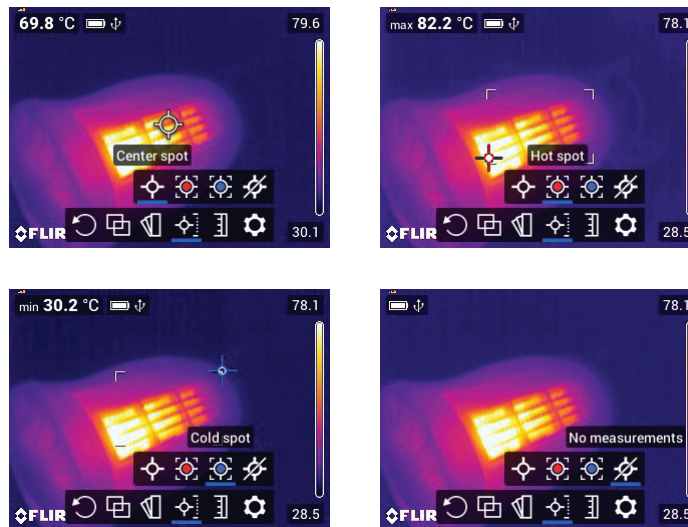

Figure 7.9 Accessing the Measurements mode menu.

## 7 Programming Menus

 Navigate to the Measurement icon and press Menu. Select from the available options, detailed below, and then press Menu to confirm.

- Centre Spot . Target a surface spot with the cross-hairs to measure its temperature. The temperature measurement is shown in the upper left corner of the display (digitally).
- Hot Spot . Position the camera so that the rectangle display target is covering an area of interest. The cross-hairs will move to the hottest (MAX) spot automatically (inside the rectangle target). The MAX temperature is shown, digitally, in the upper left corner.
- Cold Spot . Position the camera so that the rectangle display target is covering an area of interest. The cross-hairs will move to the coldest (MIN) spot automatically (inside the rectangle target). The MIN temperature is shown, digitally, in the upper left corner.
- No Measurements. 



**Figure 7.10** Select a measurement type. Centre Spot for manual targeting (temperature displayed on upper left corner of display); Hot Spot for automatic targeting of hottest spot in the target rectangle; Cold Spot for automatically targeting coldest spot in the rectangle; No Measurements for removing the temperature display digits.

## 7 Programming Menus

### 7.7 Temperature Scale Menu

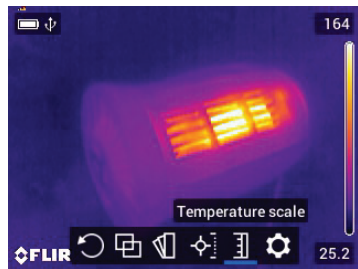



Figure 7.11 Accessing the Temperature Scale menu.

 Navigate to the Temperature Scale icon and press Menu. Use the navigation buttons to select Auto (where the camera uses the entire thermal range), or Lock (where you can freeze the range to a narrow thermal region).

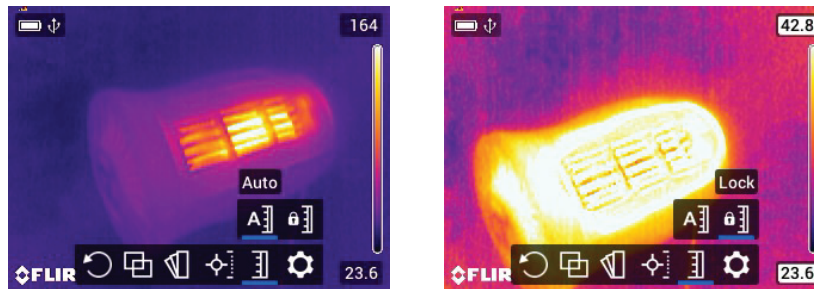



Figure 7.12 Image on left shows Auto mode where the temperature range uses all of the available spectrum. Image on right shows the Lock mode where the temperature range can be constrained. To constrain the range, point to a spot in the frame that represents the temperature of interest, and then select the Lock mode.

### 7.8 Settings Menu Overview

 The settings menu has four sub-menus: Recording mode, Measurement parameters, Save options, and Device settings. See below.

## 7 Programming Menus

### 7.9 Settings Menu

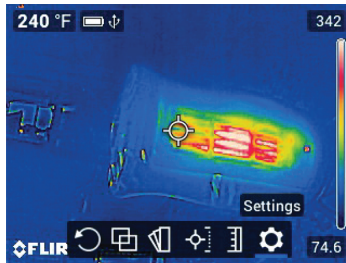

Figure 7.13 Accessing the Settings menu.

#### 7.9.1 Recording Mode Sub-Menu

Press Menu on the Settings icon and press Menu again at the Recording Mode sub-menu. Select Video or Single-shot using the navigation buttons and press Menu to confirm. Pull and hold the trigger to start/stop a video recording or to capture a single image.

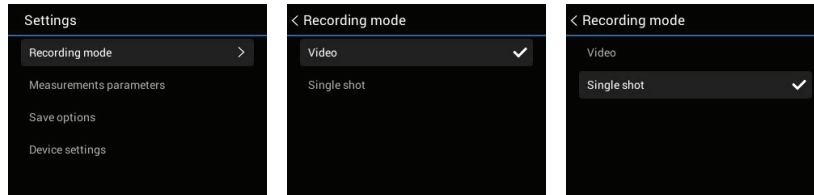

Figure 7.14 Select Video or Single shot (still image) mode. When the trigger is pulled, a video or a photo will be stored, depending on the selection made here.

## 7 Programming Menus

### 7.9.2 Measurement Parameters Sub-Menu

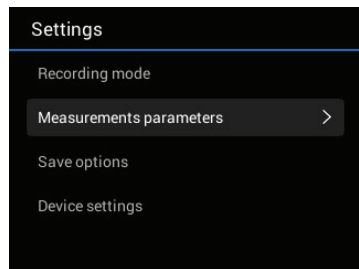

Figure 7.15 Accessing the Measurement Parameters menu.

Press Menu on the Settings icon and press Menu again at the Measurement Parameters sub-menu. Perform one or more of the steps below:

- Scroll to the Emissivity option and press Menu. Select a preset or choose a custom emissivity setting.

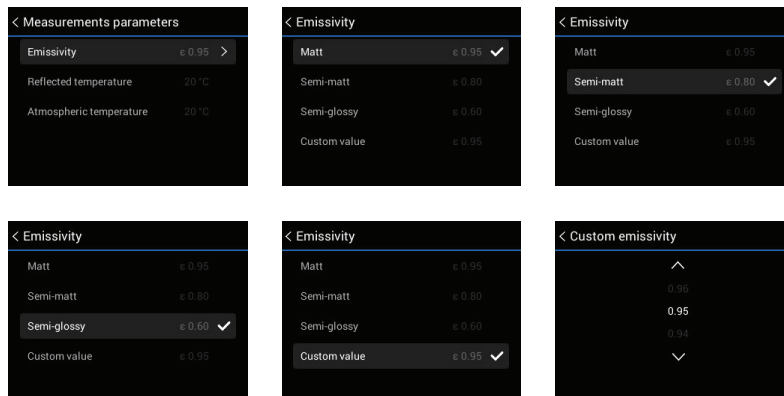
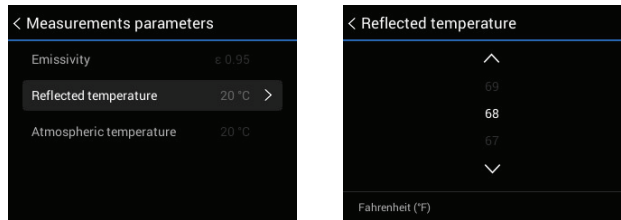

Figure 7.16 Selecting an emissivity preset or a custom setting.

## 7 Programming Menus

- Scroll to the Reflected Temperature option, press Menu, and set a reflected temperature value.



**Figure 7.17** Setting the Reflected Temperature value using the up/down arrow buttons.

- Scroll to the Atmospheric Temperature option, press Menu, and set an atmospheric temperature value.

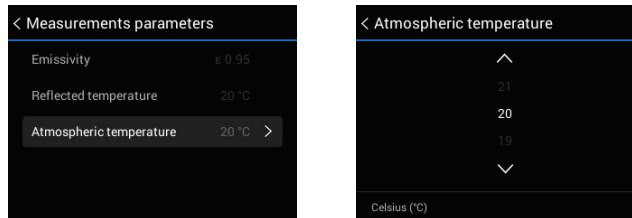

**Figure 7.18** Selecting the Atmospheric Temperature using the up/down arrow buttons.

### 7.9.3 Save Options Sub-Menu

Press Menu on the Settings icon and press Menu again at the Save Options sub-menu. When set to ON, the camera stores two images (thermal and digital) for each Thermal MSX image captured. Use the navigation buttons to set on/off and press Menu to confirm.

Note that the VSC-IR21 probe does not have MSX mode.

## 7 Programming Menus

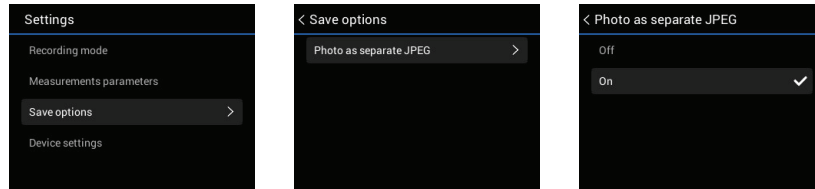

**Figure 7.19** Determine if you'll need a separate digital camera image along with each thermal image captured.

### 7.9.4 Device Settings Sub-Menu

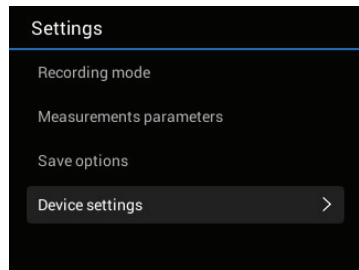

**Figure 7.20** Accessing the Device Settings sub-menu.

Press Menu on the Settings icon and press Menu again at the Device Settings sub-menu to begin programming or viewing the following items. Each menu is explained in detail below.

## 7 Programming Menus

- Set the Language, Time/Date, and Units of measure.

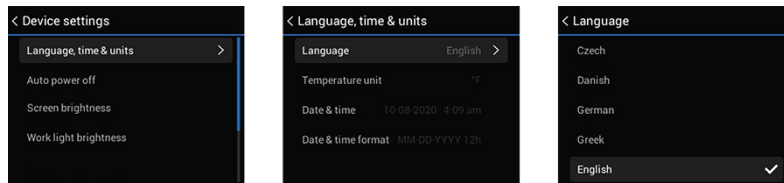

Figure 7.21 Selecting the user interface Language.

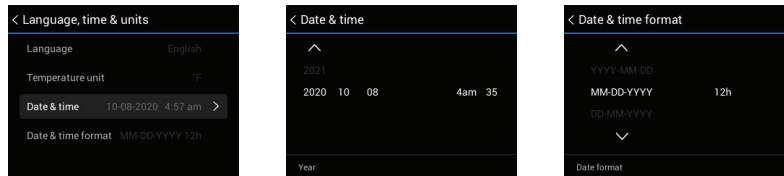

Figure 7.22 Setting the Date, Time, and Format.

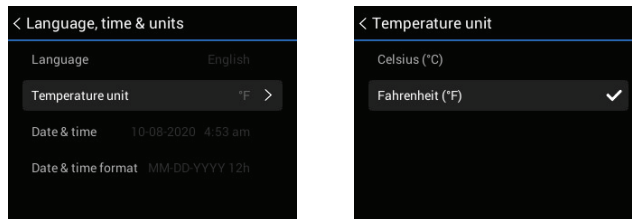

Figure 7.23 Selecting the Temperature Units.



## 7 Programming Menus

---

- Set individual Auto Power Off (APO) timers for the VS290-00 and the worklight.

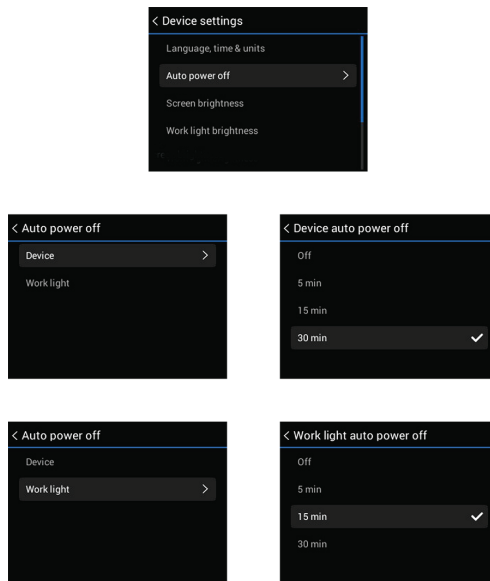

**Figure 7.24** Setting the APO time for the VS290-00 and the worklight.

## 7 Programming Menus

- Adjust the screen and worklight brightness.

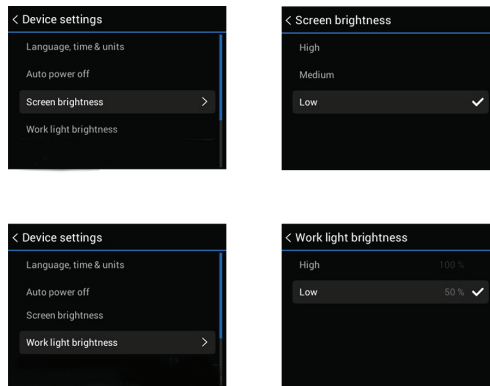

**Figure 7.25** Set the display and worklight brightness.

- View System information including serial number and firmware version. If you require technical assistance, please note the serial number for the base unit and probe, found in this menu, first, as you may be asked for this information.

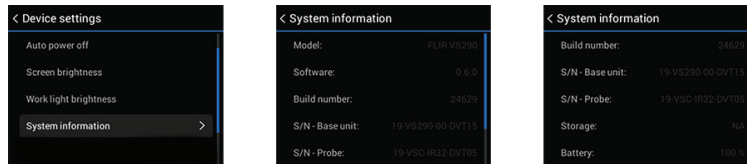

**Figure 7.26** View the System Information.

## 7 Programming Menus

- **Reset Options.** Revert to factory default conditions and/or format SD memory card. Note that the memory card cannot be formatted if a USB cable is connected to the unit.

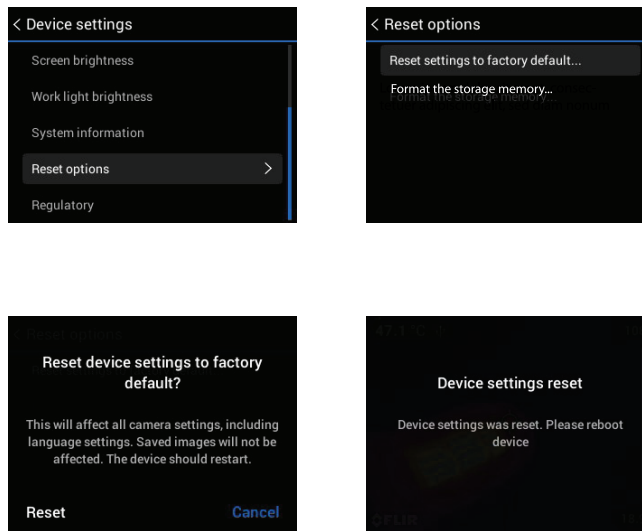

**Figure 7.27** Reset the unit to factory default conditions and/or format SD memory card.

- **View regulatory data.**

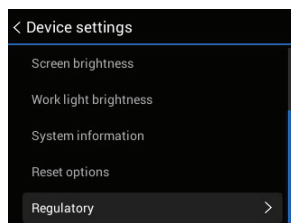

**Figure 7.28** Accessing the regulatory compliance information.

# 8 Taking Measurements

---

## NOTE

Before proceeding to put this device into professional operation ensure that all system, safety, and programming information is well understood as explained in this user manual.

## NOTE

Please update the VS290-00 Videoscope Display's firmware, as explained in Section 14, before first use and periodically thereafter, to ensure optimum performance.

### 8.1 Charge and Install the Battery

As discussed in Section 5, *Battery Charging*, place the batteries in the supplied bay charger. Connect the charging bay to the supplied AC adaptor, and then connect the AC adaptor to an AC source to begin charging.

Once charged, insert a battery into the VS290-00 and long press the power button  to power the instrument.

### 8.2 Power-up Display Configuration

When you power up the VS290-00, the display will show the camera image for the currently selected Image Mode (Thermal MSX, Thermal, or Digital camera). The digits and icons that are displayed also depend on the configuration of the camera. See Section 4.5, *Display Description*, for details.

### 8.3 Programming the Instrument

Before taking measurements you'll want to configure the instrument to best match the application at hand. See the following parameter list for the most commonly used options. Refer to Section 7, *Programming Menus*, for complete instructions on these and other options.

- Image Mode (Thermal MSX, Thermal-only Camera, or Digital Camera).
- Thermal display color palette.
- Measurement Mode (Color spot, Hot spot, Cold spot, or No Measurements).
- Emissivity.
- User interface Language.
- Temperature units (°C / °F).
- Auto Power Off (APO) timers for the worklight and the VS290-00.
- Display and worklight brightness.

## 8 Taking Measurements

---

### 8.4 Positioning the Probe into the Test area



#### CAUTION

The VS290-32 and VS290-33 are suitable for use in CAT IV 600 V AC environments. The VS290-21 is not intended for use in high voltage (> 600 V AC) environments.



#### CAUTION

Ensure that the VS290-00 is powered off before removing or attaching probes. Do not attempt to remove or attach a probe with the VS290-00 powered up.

Note that the release tab (item no. 10 in Figure 4.1) must be pushed to release a probe from the Videoscope display when removing it.

1. Carefully position the probe into the area to be examined, as shown in accompanying figure.



**Figure 8.1** Inserting the probe into the test area.



## 8 Taking Measurements

---

2. View the image for the area you are inspecting.



**Figure 8.2** View the test area on the VS290-00 display.

3. Short press the worklight button  to switch the light on/off if added illumination will help in your inspection work.
4. To select an image mode, press the Menu button (centre), scroll to the Image Mode icon and press Menu again. Use the navigation buttons to select Thermal MSX, Thermal, or Digital camera; press Menu to confirm. Note that the VSC-IR21 does not have an MSX or a digital camera mode.
5. The cross-hairs allow you to target and measure the temperature of a surface area. The measurement is shown digitally (upper left). The thermal scale for the current image is shown on the right edge of the display.
6. To capture an image or to stop/start a video, pull and hold the trigger. Press the Gallery button  to view stored images and videos. Images/videos can be transported to a PC via USB.
7. The image orientation may be changed by rotating the probe. It can also be changed by rotating the displayed image electronically (see section 7.3, *Image Rotation Menu*).

# 9 Isothermal Alarms

## 9.1 Isotherms Overview

Isotherm Alarms allow you to set a high and/or low temperature set point. The image colorings show the areas that exceed the set point temperatures. To configure the Isotherms, open the Color menu and select the desired alarm mode. Use the navigation arrows to select the temperature set point. The hot alarm color cold is red while the cold alarm color code is blue.

## 9.2 Isotherm Screen Shots

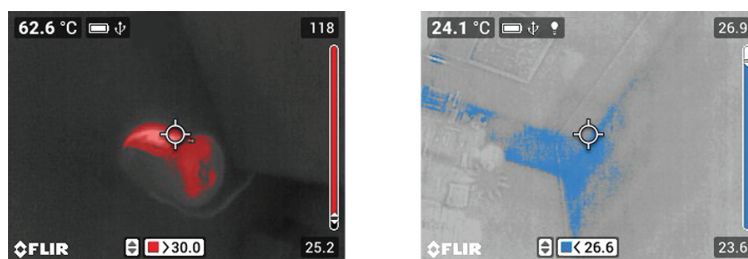

**Figure 9.1** 'Above Alarm' (left) shows a high temperature alarm setup. The alarm set point is shown on the bottom of the display (red), use the up/down arrows to adjust the set point. 'Below Alarm' (right) shows a low temperature alarm setup. The alarm set point is shown on the bottom of the display (blue), use the up/down arrows to adjust the set point.

# 10 Working with Images and Video

---

## 10.1 General SD Card Usage Information

The SD card slot is located inside the VS290–00 top compartment. See illustration below. Do not remove or insert an SD card while the camera is powered. All images and videos that you capture will be stored on this card.

The supplied SD card is formatted at the factory, no formatting is necessary. Do not use an SD card that has been formatted by another camera as the file system may differ. To format an SD card, refer to the Reset Options paragraph in Section 7.9.4, *Device Settings Sub-Menu*.

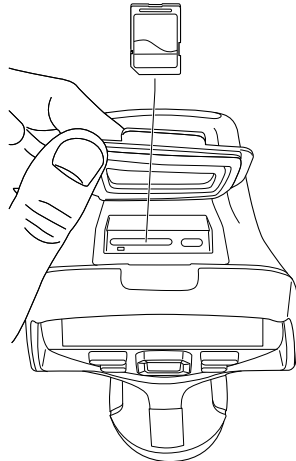

**Figure 10.1** SD card slot in top compartment.

## 10.2 Capturing Images and Video

First select image mode (single-shot) or Video mode in the Recording Mode sub-menu. To do so, press the Menu button to open the main menu, scroll to the Settings icon (far right), and press Menu again. Press Menu a third time at the Recording Mode sub-menu. Select Video or Single-shot using the navigation buttons and press Menu to confirm.

Pull and hold the trigger to capture an image or to start recording video. For images, release the trigger when the filename appears. For video, release the trigger when the video timer starts. Pull and hold the trigger to stop the video



## 10 Working with Images and Video

---

recording. Note that images and video cannot be captured if a USB cable is connected to the Videoscope.

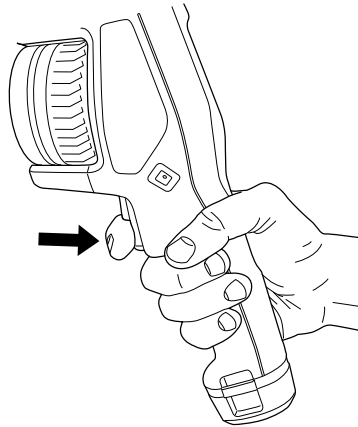

**Figure 10.2** Pull and hold the trigger to capture an image or start a video.

### 10.3 Viewing Images and Video

Press the Gallery button  to open the image/video gallery. Scroll to an image/video and press Menu to open it. Press Menu again at an opened image/video to access these options: Play (video only), full screen mode, image/video information, and image/video delete.

### 10.4 Transferring Images and Video

Transfer to a PC by first connecting the VS290-00 to a PC using the supplied USB cable (the USB connector is located in the VS290-00 top compartment), and then use the VS290-00 as you would a typical external storage drive.

You can also transfer images and videos directly from the SD card. With the camera power off, remove the SD card from the VS290-00 top compartment and insert it into a standard SD card reader. Follow the instructions provided by the SD card reader manufacturer.

## 10 Working with Images and Video

---

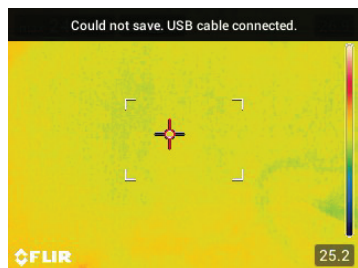

**Figure 10.3** The VS290–00 must be not be connected via USB, otherwise the error message shown will appear when you attempt to capture an image or a video.

# 11 MSX Imaging Technology

Note that the VSC-IR21 probe does not include MSX.

MSX (Multi-Spectral Dynamic Imaging) extracts scene details from the built-in visual camera and embosses them onto the full thermal image. This allows you to see the thermal image in context of the environment you are viewing. The added context assists in accurately targeting potential problems in electrical, mechanical, and building applications.

For best results in darker areas, turn the worklight on when using MSX.

Press Menu on the Image Mode icon and use the navigation buttons to select Thermal MSX. See the menu in Section 7.4, *Image Mode*, for complete programming details.

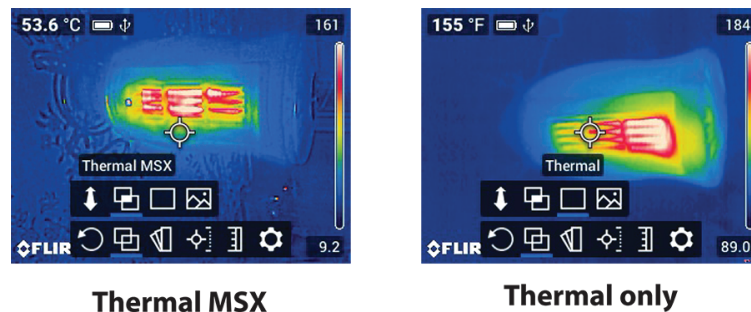

**Figure 11.1** Thermal MSX image on left shows the detail from the digital camera image superimposed on the thermal image. Image on right shows the thermal only version.

# 12 Specifications

<b>IMAGING AND OPTICAL SPECIFICATIONS</b>	
IR Resolution	160 x 120 pixels
Digital image enhancement	Yes
Thermal sensitivity /NETD	< 100 mK
Field of View (FOV)	57° x 44°
Minimum focus distance	0.15 m (5.9 in.); 0.65 m (25.6 in.) in MSX mode.
Image frequency	8.7 Hz
<b>IMAGE PRESENTATION</b>	
Display	320 x 240 pixel RGB LCD
Screen size	3.5 in. (8.9 cm)
Color palettes	Iron, Rainbow, Gray, and Below/Above Alarms
Image modes	IR only, visual only, MSX (Note that the VSC-IR21 probe does not have an MSX or a visual camera mode)
<b>MEASUREMENT AND ANALYSIS</b>	
Object temperature range	14°F to 752°F (-10°C to 400°C)
Measurement accuracy	At ambient temperature. 15 to 35°C (59 to 95°F) and object temp. above 0°C (32°F) 0 to 100°C (32 to 212°F): ±3°C (±5.5°F) 100 to 400°C (212 to 752°F): ±3%
Measurement options (spot meter)	Centre spot, Hot spot, Cold spot, and <i>No Measurement</i> modes
Emissivity correction	3 presets and 1 custom setting
<b>IMAGE STORAGE AND VISUAL (DIGITAL) CAMERA</b>	
Storage capacity	Removable SD card (16 GB)
Image/Video file formats	Image: Radiometric .jpg Video: .mpeg-4
Digital camera resolution	2 MP (not available on VSC-IR21 probe)
Field of View (FOV)	83°
<b>WORKLIGHT</b>	
Worklight type	Bright LED (not available on VSC-IR21 probe)

<b>DATA COMMUNICATION</b>	
USB	USB Type-C for data transfer
<b>BATTERY</b>	
Battery type	Rechargeable 3.7 V Lithium ion
Battery operating time	> 5 hours (full display brightness and worklight ON)
<b>DIMENSIONS AND WEIGHT</b>	
Weight (including battery)	Complete VS290–21 kit with case: 5.4 kg (11.9 lbs.) Complete VS290–32 kit with case: 13 kg (28.7 lbs.) Complete VS290–33 kit with case: 13 kg (28.7 lbs.) VS290–00 Videoscope Display: 640 g (1.4 lbs.)
Dimensions	VS290–21 kit with case (L x W x H): 54 x 35 x 17 cm (21.3 x 13.8 x 6.7 in.) VS290–32 kit with case (L x W x H): 120 x 48 x 20 cm (47 x 18.9 x 7.9 in.) VS290–33 kit with case (L x W x H): 120 x 48 x 20 cm (47 x 18.9 x 7.9 in.) VS290–00 Videoscope Display: 26.4 x 11 x 11 cm (10.4 x 4.3 x 4.3 in.) VSC-IR21 probe: 111.5 x 6.9 cm (43.9 x 2.7 in.) VSC-IR32 probe: 212.2 x 0.69 cm (83.5 x 0.3 in.) VSC-IR33 probe: 211.9 x 6.9 cm (83.5 x 2.7 in.) VSC-IR21 and VSC-IR33 probe tip diameter: 19 mm (0.75 in.) VSC-IR32 probe tip (L x W x H): 71.7 x 40.5 x 11 mm (2.8 x 1.6 x 0.4 in.)

12      **Specifications**

---

<b>SAFETY</b>	
Safety Compliance	<p>General Safety: Conforms to UL STD 61010-1; Certified to CSA STD C22.2, no. 61010-1.</p> <p>Environmental Safety: ETL (EN 61010-1), CE, UKCA, RCM, FCC, WEEE, RoHS, REACH. Department of Energy and California Title 20 Battery Charging Systems Efficiency.</p> <p>Encapsulation: IP 67 (camera tip) and IP 54 (probe and Videoscope Display).</p> <p>Electrical Safety: VS290-32 and VS290-33 are rated for use in CAT IV 600 V AC environments. VS290-21 is not intended for use in high voltage (&gt; 600 V AC) environments.</p>
<b>SUPPLIED EQUIPMENT AND ACCESSORIES</b>	
Videoscope display, camera probe, rechargeable batteries (2), battery charger, AC adaptor for charger, formatted SD card, USB cable, wrist strap, hard case, printed documentation, and complimentary <i>FLIR Thermal Studio Standard</i> one-year subscription.	

# 14 Firmware Updates

---

Update the VS290–00 Videoscope Display firmware before use to ensure that your probe(s) will operate optimally with the Videoscope Display. As new probes are introduced into the product family, your Videoscope Display firmware may need an update to accommodate them.

The firmware files, and instructions for performing the update, are available at the web address below:

# 15 Warranty and Product Registration

---

## 15.1 2–10 Extended Warranty

To activate the extended 2–10 warranty, please register your product within 60 days of purchase. Otherwise, the standard one-year warranty will be in effect from date of purchase. The 2–10 warranty covers parts and labour for the camera for 2 years and coverage of the detector for 10 years.

## 15.2 Product Registration

Register your purchases at this web address: